



Arlington®

GANGABLE FLOOR BOX

FOR NEW CONCRETE

WITH PLASTIC & METAL COVER KITS



ASSEMBLE THE BOX YOU NEED – FAST!

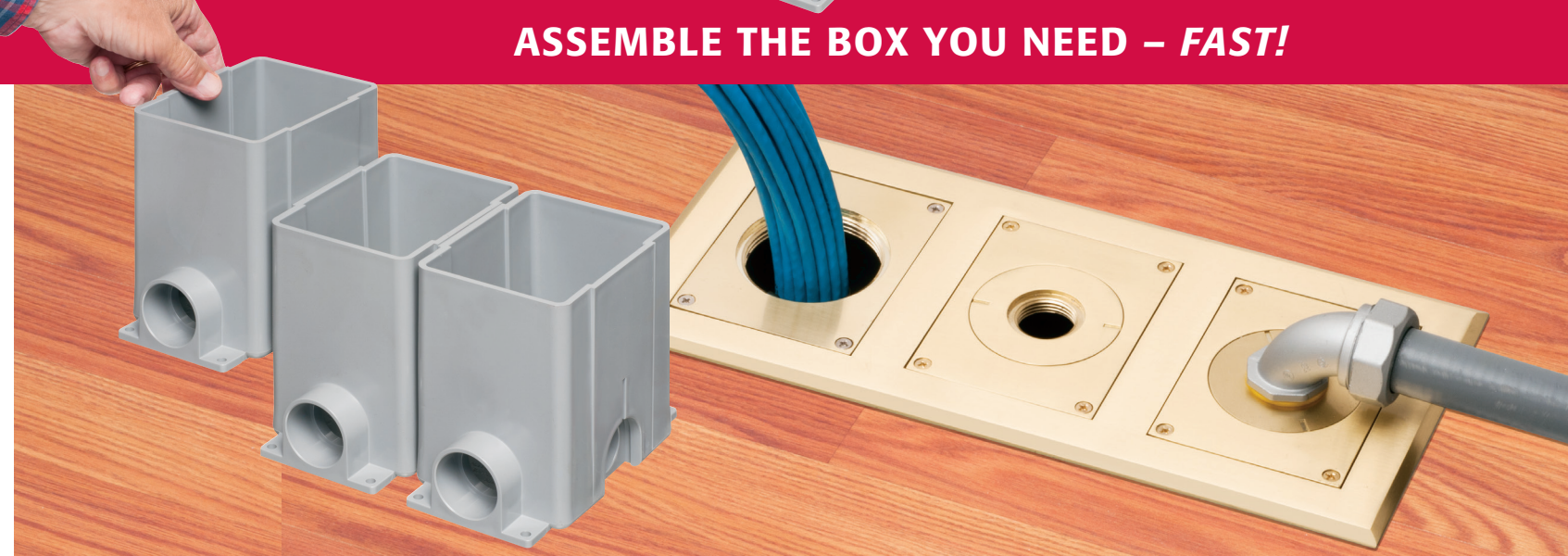

INTERLOCKING • UL LISTED • FOR COMMERCIAL USE

UL LISTED

GANGABLE FLOOR BOX

ECONOMICAL • CONVENIENT RECEPTACLE INSTALLATION

Arlington manufactures a complete line of floor box kits, boxes, covers and accessories for new concrete – and other applications.

Our UL Listed **GANGABLE FLOOR BOXES** and the **COVER KITS** featured here are designed for commercial installations. Available with 1-1/4" or 2" conduit hubs, these gangable boxes give installers an economical, convenient way to add receptacles in **new concrete** pours.

You can use the interlocking single gang box as shipped, or join them together to build the two- or three-gang box you need. You decide. Then buy the economical brass or nickel-plated zinc, or plastic cover/frame kit to fit. *Our cover kits, except those with furniture feed inserts, include a 20A receptacle and low voltage insert.*

The gasketed frame mounts to the box. Then the cover mounts to the frame, protecting devices against water intrusion when not in use.

Gangable boxes have openings for OPTIONAL 1/4"-20 screws that position, level and raise the box so concrete flows beneath.



NEW COVER KITS
*Two Flip Lids, pgs 6-8...
Furniture Feed inserts w 1" threaded opening...pg 9*



FLBC8524NL
PLATED ZINC cover/frame kit

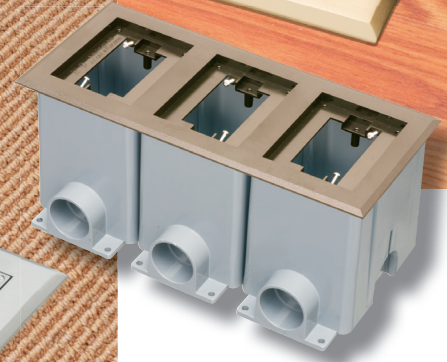

FLBC8535BR
PLASTIC cover/frame kit

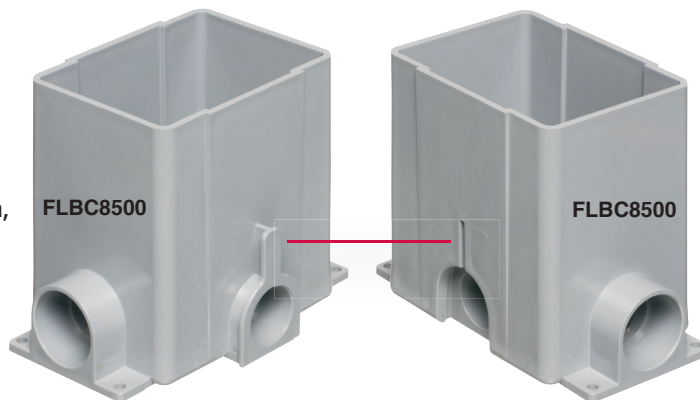

Connections on opposing sides lock Gangable Boxes securely together

Install FLBC8510, FLBC8520, FLBC8530 covers with hinge on either side. Repositioning the Cover is EASY!

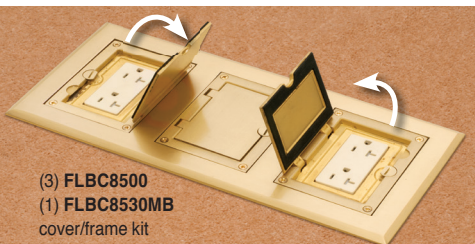

(3) FLBC8500
(1) FLBC8530MB
cover/frame kit



Remove Cover
(hinge on right)



Rotate and
reinstall cover



Hinge now on left

800.233.4717 • www.aifittings.com • EMAIL sales@aifittings.com

FOR NEW CONCRETE

INTERLOCKING • EASY ASSEMBLY OF MULTIPLE-GANG BOXES

GANGABLE FLOOR BOX KIT

CATALOG NUMBER	UPC/DCI/NAED MFG. #018997	DESCRIPTION/ CONDUIT HUB SIZE	COLOR/ MATERIAL	UNIT PKG	STD PKG
FLBC8500	22950	Single gang Gangable Box kit with (2) built-in 1-1/4" hubs	Non-metallic, Gray	1	5
FLBC8502	22949	Single gang Gangable Box kit with (2) built-in 2" hubs	Non-metallic, Gray	1	5

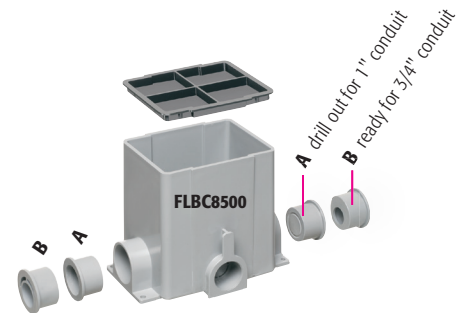

FLBC8500 includes concrete box/mud cover, (2) 3/4" conduit bushings and (2) blank plugs* that fit the 1-1/4" hubs (*w/ knockout for 1" conduit).

FLBC8502 includes concrete box/mud cover and (2) blank plugs* for the 2" hubs (*w/ knockout for 1-1/2" conduit). Also included are (2) conduit bushings ready for use with 1-1/4" conduit. These bushings accommodate the (2) supplied 3/4" conduit bushings.

Both boxes include the hubs and plugs you'll need to complete most installations.

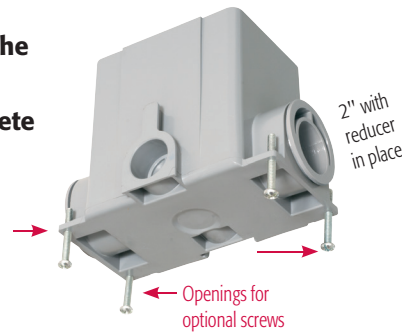

FLBC8500 and FLBC8502
Patented • Made in USA

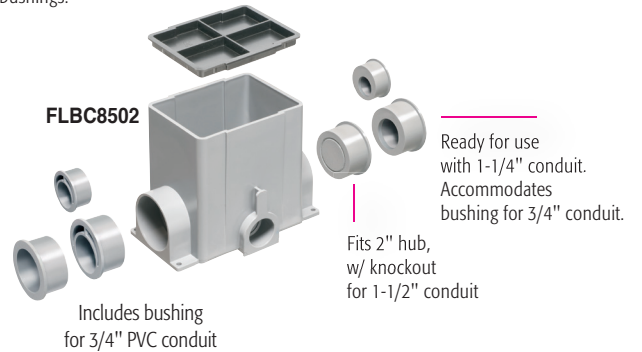

HERE'S HOW IT WORKS

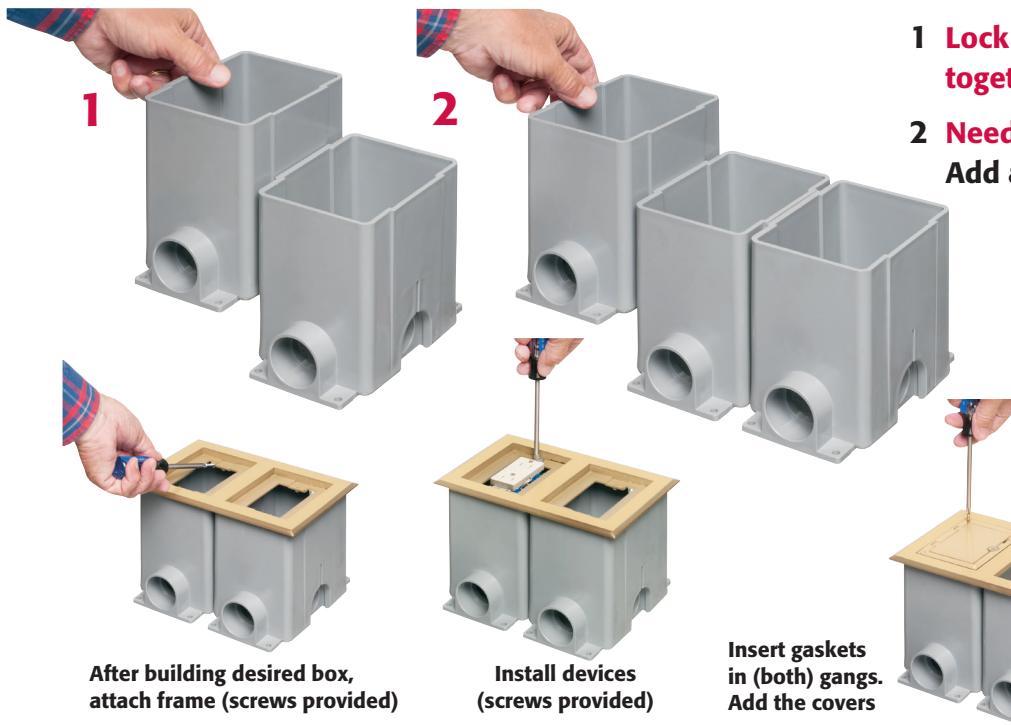

After building desired box, attach frame (screws provided)

Install devices (screws provided)

Insert gaskets in (both) gangs. Add the covers

- 1 Lock two single-gang boxes together for a two-gang box.**
- 2 Need a three-gang box instead? Add another box!**



Arlington®

PLASTIC COVERS, 5 COLORS

RECTANGULAR NON-METALLIC COVERS



(2) FLBC8500 boxes
(1) FLBC8520LA
Light Almond
plastic cover/frame kit

(3) FLBC8500 boxes
(1) FLBC8530BL
Black plastic cover/frame kit

Patented

PLASTIC COVER KITS FOR FLBC8500, FLBC8502

CATALOG NUMBER	UPC/DCI/NAED MFG. #018997	DESCRIPTION	PLASTIC COVER COLOR	UNIT PKG	STD PKG
----------------	---------------------------	-------------	---------------------	----------	---------

SINGLE GANG PLASTIC COVER / FRAME KITS

FLBC8510BL	22964	Single gang Frame	Black	1	1
FLBC8510BR	22965	Single gang Frame	Brown	1	1
FLBC8510GY	22966	Single gang Frame	Gray	1	1
FLBC8510LA	22976	Single gang Frame	Light Almond	1	1
FLBC8510CA	22975	Single gang Frame	Caramel	1	1

Includes single gang frame, (1) flip lid cover with gasket, (1) 20A decorator-style receptacle, (1) gasket, (1) low voltage insert, installation screws.

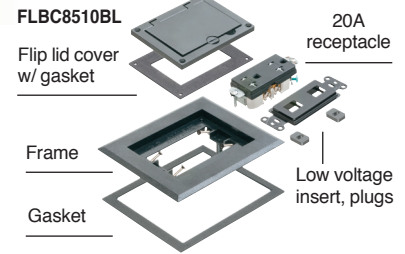

TWO GANG PLASTIC COVER / FRAME KITS

FLBC8520BL	22967	Two gang Frame	Black	1	1
FLBC8520BR	22968	Two gang Frame	Brown	1	1
FLBC8520GY	22969	Two gang Frame	Gray	1	1
FLBC8520LA	22978	Two gang Frame	Light Almond	1	1
FLBC8520CA	22977	Two gang Frame	Caramel	1	1

Includes two gang frame, (2) flip lid covers with gaskets, (2) 20A decorator-style receptacles, (2) gaskets, (2) low voltage inserts, installation screws.

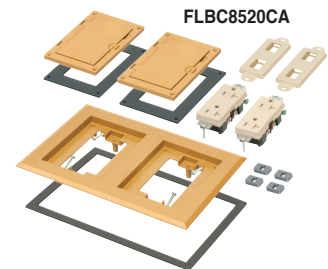

THREE GANG PLASTIC COVER / FRAME KITS

FLBC8530BL	22970	Three gang Frame	Black	1	1
FLBC8530BR	22971	Three gang Frame	Brown	1	1
FLBC8530GY	22972	Three gang Frame	Gray	1	1
FLBC8530LA	22980	Three gang Frame	Light Almond	1	1
FLBC8530CA	22979	Three gang Frame	Caramel	1	1

Includes three gang frame, (3) flip lid covers with gaskets, (3) 20A decorator-style receptacles, (3) gaskets, (3) low voltage inserts, installation screws.

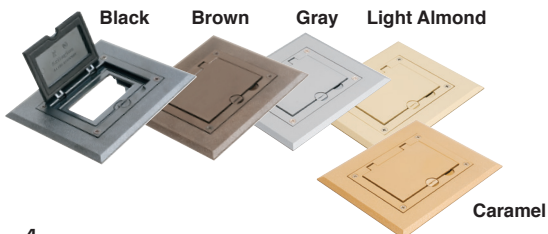
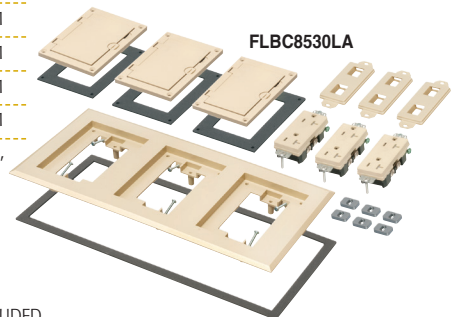

ALSO AVAILABLE

SINGLE GANG PLASTIC COVER INSERTS

Gasketed Frame, installation screws NOT INCLUDED

METAL COVERS

FOR NEW CONCRETE, COMMERCIAL WORK

PLATED AND POWDER-COATED OPTIONS



(3) FLBC8500 boxes
(1) FLBC8530NL Kit

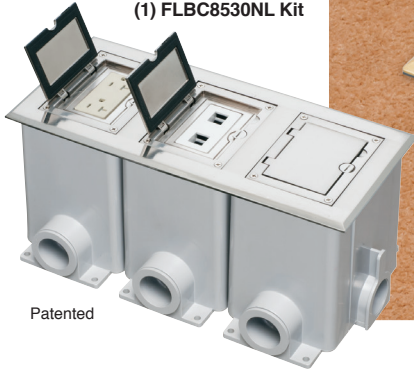

Patented

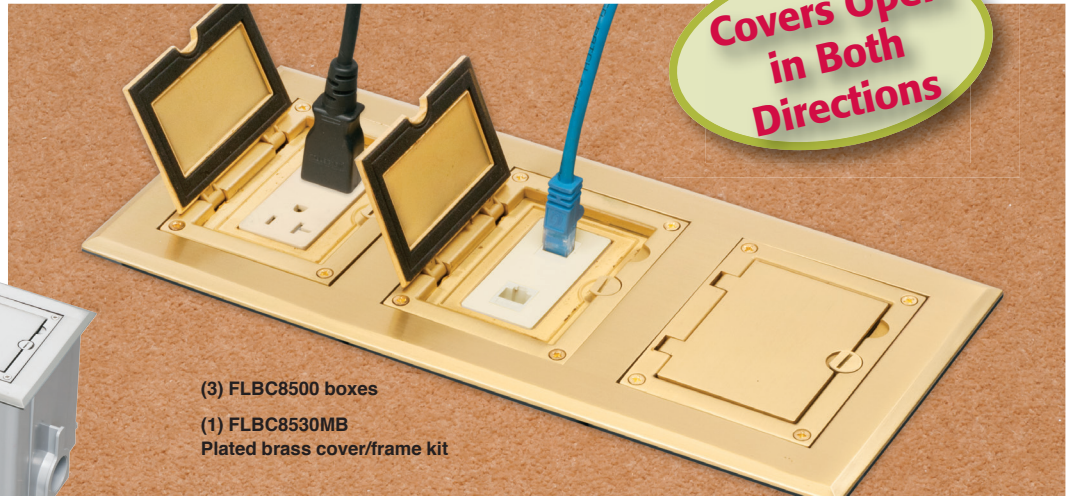

Covers Open in Both Directions

(3) FLBC8500 boxes
(1) FLBC8530MB
Plated brass cover/frame kit

METAL COVER KITS FOR FLBC8500, FLBC8502

CATALOG NUMBER	UPC/DCI/NAED MFG. #018997	DESCRIPTION	ZINC COVER FINISH	UNIT PKG	STD PKG
----------------	---------------------------	-------------	-------------------	----------	---------

SINGLE GANG COVER / FRAME KITS

FLBC8510MB	22953	Single gang Frame	Brass-plated zinc	1	1
FLBC8510NL	22954	Single gang Frame	Nickel-plated zinc	1	1
FLBC8510BK	42350	Single gang Frame	Black powder-coated zinc	1	1
FLBC8510BN	42351	Single gang Frame	Brown powder-coated zinc	1	1

Includes single gang frame, (1) flip lid cover with gasket, (1) 20A decorator-style receptacle, (1) gasket, (1) low voltage insert, installation screws.

TWO GANG COVER / FRAME KITS

FLBC8520MB	22955	Two gang Frame	Brass-plated zinc	1	1
FLBC8520NL	22956	Two gang Frame	Nickel-plated zinc	1	1
FLBC8520BK	42352	Two gang Frame	Black powder-coated zinc	1	1
FLBC8520BN	42353	Two gang Frame	Brown powder-coated zinc	1	1

Includes two gang frame, (2) flip lid covers with gaskets, (2) 20A decorator-style receptacles, (2) gaskets, (2) low voltage inserts, installation screws.

THREE GANG COVER / FRAME KITS

FLBC8530MB	22957	Three gang Frame	Brass-plated zinc	1	1
FLBC8530NL	22958	Three gang Frame	Nickel-plated zinc	1	1
FLBC8530BK	42354	Three gang Frame	Black powder-coated zinc	1	1
FLBC8530BN	42355	Three gang Frame	Brown powder-coated zinc	1	1

Includes three gang frame, (3) flip lid covers with gaskets, (3) 20A decorator-style receptacles, (3) gaskets, (3) low voltage inserts, installation screws.

ALSO AVAILABLE

SINGLE GANG METAL COVER INSERTS

Gasketed Frame, installation screws NOT INCLUDED

NEW!

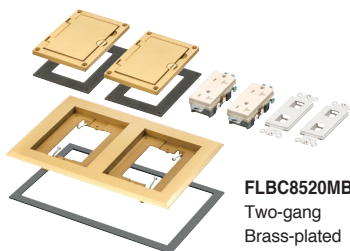
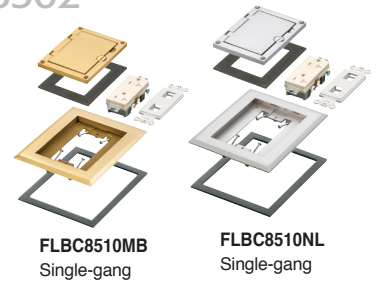

Not shown
FLBC8520NL
Two-gang, Nickel-plated

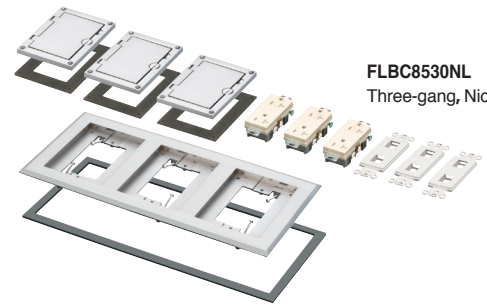

FLBC8530NL
Three-gang, Nickel-plated

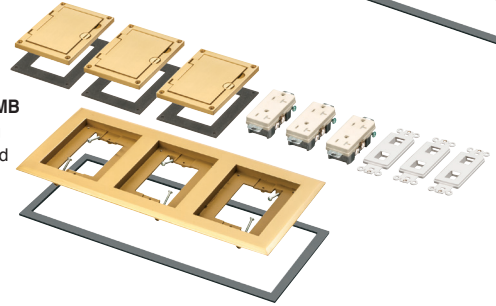

FLBC8530MB
Three-gang
Brass-plated



NEW!

MODULAR SINGLE Gang

COVER SHAPE



PLASTIC COVER KITS

WITH FLIP LIDS, 20A RECEPTACLES

Covers Open in Both Directions



(3) FLBC8500 boxes
(1) FLBC8534BL
Black plastic cover/frame kit

Plastic cover w/ flip lids, gasket, 20A receptacle and mounting screws

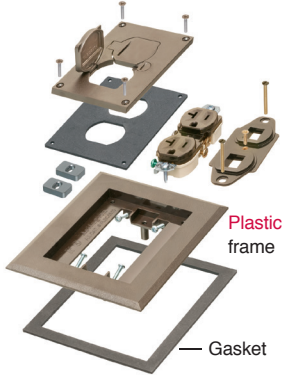

Plastic frame

Gasket

FLBC8514BR
Single-gang, Brown

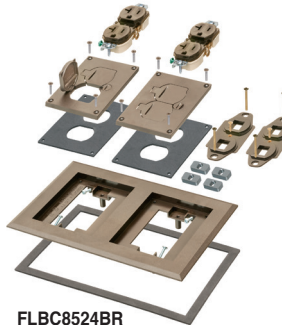

FLBC8524BR
Two-gang, Brown

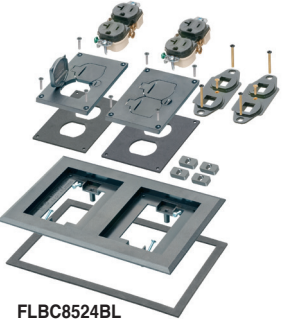

FLBC8524BL
Two-gang, Black

PLASTIC COVER KITS FOR FLBC8500, FLBC8502

CATALOG NUMBER	UPC/DCI/NAED MFG. #018997	DESCRIPTION	PLASTIC COVER FINISH	UNIT PKG	STD PKG
----------------	---------------------------	-------------	----------------------	----------	---------

SINGLE GANG COVER /GASKET INSERT

FLBC8504BR	20829	Cover/gasket for Single gang Frame	Brown	1	1
FLBC8504BL	20828	Cover/gasket for Single gang Frame	Black	1	1

Includes PLASTIC single gang gasketed cover with mounting screws.

*for Arlington's FLBC8514, FLBC8524 and FLBC8534 PLASTIC cover kit frames.

SINGLE GANG COVER / FRAME KITS

FLBC8514BR	20831	Single gang Frame Kit	Brown	1	1
FLBC8514BL	20830	Single gang Frame Kit	Black	1	1

Includes PLASTIC single gang frame, cover with gasket and a 20A receptacle, low voltage duplex plate, spacers and mounting screws.

TWO GANG COVER / FRAME KITS

FLBC8524BR	20833	Two gang Frame Kit	Brown	1	1
FLBC8524BL	20832	Two gang Frame Kit	Black	1	1

Includes PLASTIC two gang frame, covers with gaskets and (2) 20A receptacles, low voltage duplex plate, spacers and mounting screws.

THREE GANG COVER / FRAME KITS

FLBC8534BR	20835	Three gang Frame Kit	Brown	1	1
FLBC8534BL	20834	Three gang Frame Kit	Black	1	1

Includes PLASTIC three gang frame, covers with gaskets and (3) 20A receptacles, low voltage duplex plate, spacers and mounting screws.

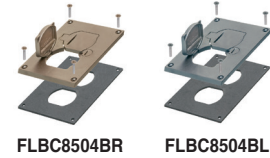

FLBC8504BR **FLBC8504BL**

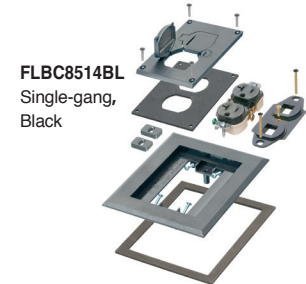

FLBC8514BL
Single-gang, Black

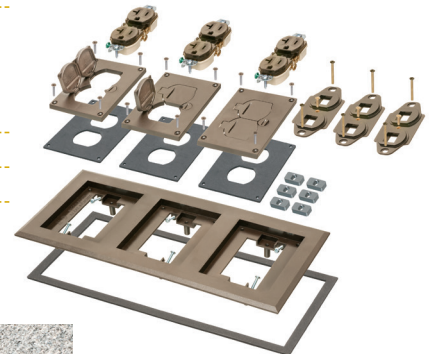

FLBC8534BR
Three-gang, Brown

Not shown:
FLBC8534BL
Three-gang, Black



NEW!

**MODULAR SINGLE Gang
COVER SHAPE**

POWDER COATED COVER KITS

WITH FLIP LIDS, 20A RECEPTACLES



Powder coated zinc cover w/ flip lids, gasket, 20A receptacle and mounting screws

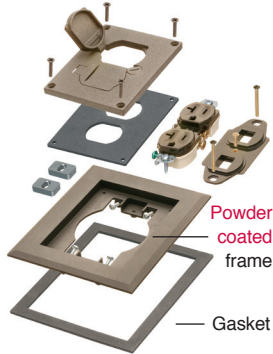

FLBC8514BN
Single-gang, Brown



(3) FLBC8500 boxes
(1) FLBC8534BN
Brown powder coated
cover/frame kit

POWDER COATED ZINC COVER KITS

CATALOG NUMBER	UPC/DCI/NAED MFG. #018997	DESCRIPTION	POWDER COATED ZINC COVER FINISH	UNIT PKG	STD PKG
----------------	---------------------------	-------------	---------------------------------	----------	---------

SINGLE GANG COVER /GASKET INSERT

FLBC8504BN	20837	Cover/gasket for Single gang Frame	Brown	1	1
FLBC8504BK	20836	Cover/gasket for Single gang Frame	Black	1	1

Includes POWDER COATED ZINC single gang gasketed cover with mounting screws.

*for Arlington's FLBC8514, FLBC8524 and FLBC8534 POWDER COATED ZINC cover kit frames.

SINGLE GANG COVER / FRAME KITS

FLBC8514BN	20839	Single gang Frame Kit	Brown	1	1
FLBC8514BK	20838	Single gang Frame Kit	Black	1	1

Includes POWDER COATED ZINC single gang frame, cover with gasket and a 20A receptacle, low voltage duplex plate, spacers and mounting screws.

TWO GANG COVER / FRAME KITS

FLBC8524BN	20841	Two gang Frame Kit	Brown	1	1
FLBC8524BK	20840	Two gang Frame Kit	Black	1	1

Includes POWDER COATED ZINC two gang frame, covers with gaskets and (2) 20A receptacles, low voltage duplex plate, spacers and mounting screws.

THREE GANG COVER / FRAME KITS

FLBC8534BN	20843	Three gang Frame Kit	Brown	1	1
FLBC8534BK	20842	Three gang Frame Kit	Black	1	1

Includes POWDER COATED ZINC three gang frame, covers with gaskets and (3) 20A receptacles, low voltage duplex plate, spacers and mounting screws.

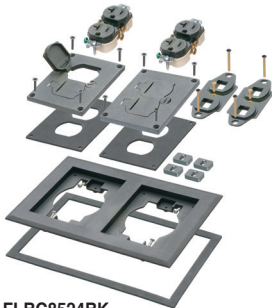

FLBC8524BK
Two-gang, Black

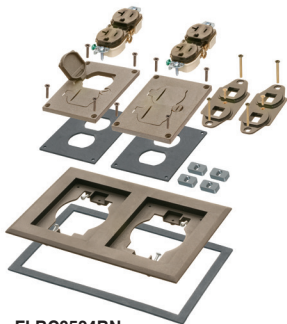

FLBC8524BN
Two-gang, Brown

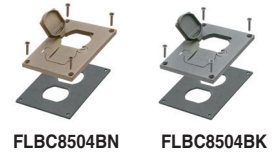

FLBC8504BN FLBC8504BK



FLBC8514BK
Single-gang
Black

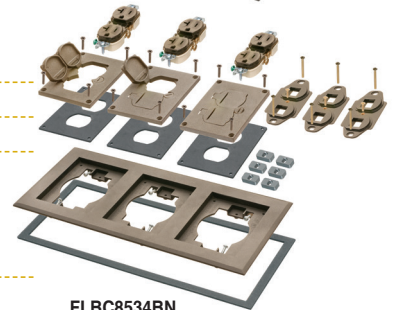

FLBC8534BN
Three-gang, Brown

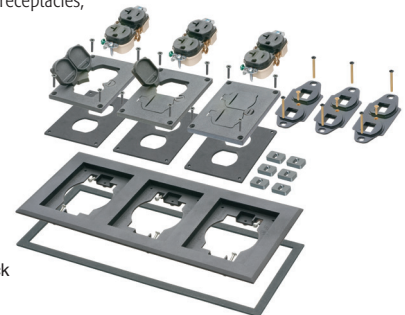

FLBC8534BK
Three-gang, Black

FOR FLBC8500
and
FLBC8502 BOXES

800.233.4717 • www.aifittings.com • EMAIL sales@aifittings.com

NEW!

**MODULAR SINGLE Gang
COVER SHAPE**

PLATED COVER KITS

**FOR NEW CONCRETE,
COMMERCIAL WORK**

WITH FLIP LIDS, 20A RECEPTACLES



Plated zinc cover w/ flip lids, gasket, 20A receptacle and mounting screws

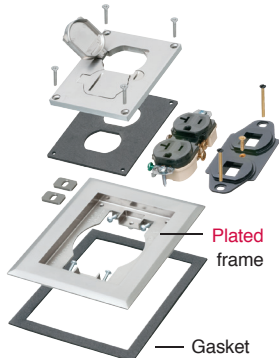

FLBC8514NL
Single-gang Nickel-plated



FLBC8514MB
Single-gang Brass-plated

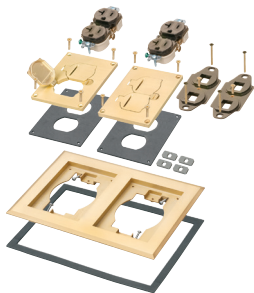

FLBC8524MB
Two-gang Brass-plated

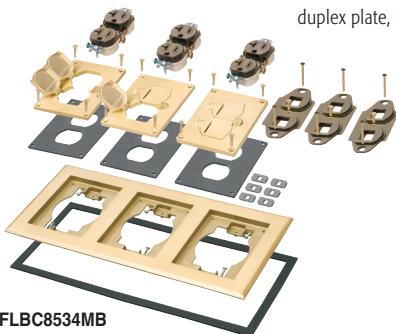

FLBC8534MB
Three-gang Brass-plated

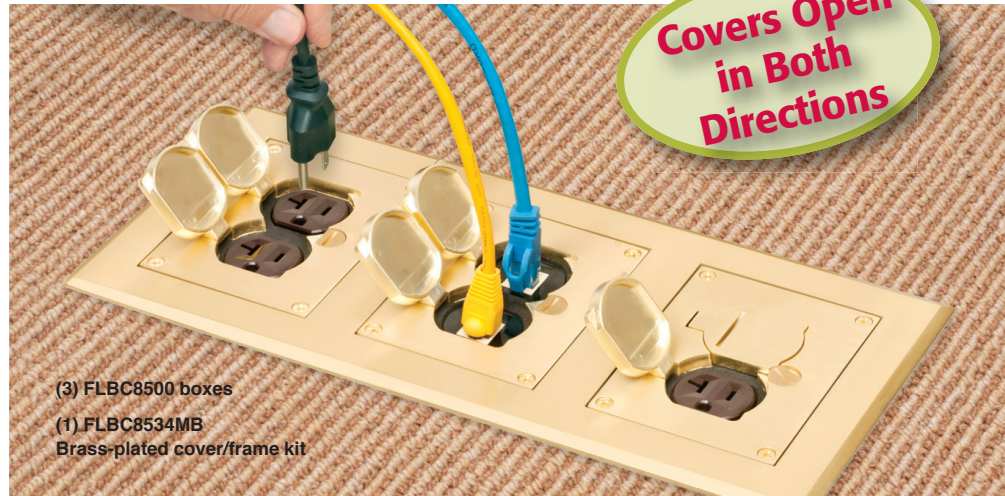

(3) FLBC8500 boxes
(1) FLBC8534MB
Brass-plated cover/frame kit

PLATED ZINC COVER KITS

CATALOG NUMBER	UPC/DCI/NAEF MFG. #018997	DESCRIPTION	PLATED ZINC COVER FINISH	UNIT PKG	STD PKG
----------------	---------------------------	-------------	--------------------------	----------	---------

SINGLE GANG COVER /GASKET INSERT

FLBC8504MB	42360	Cover/gasket for Single gang Frame	Brass-plated	1	1
FLBC8504NL	42361	Cover/gasket for Single gang Frame	Nickel-plated	1	1

Includes PLATED ZINC single gang gasketed cover with mounting screws.

***for Arlington's FLBC8514, FLBC8524 and FLBC8534 PLATED ZINC cover kit frames.**

SINGLE GANG COVER / FRAME KITS

FLBC8514MB	42362	Single gang Frame Kit	Brass-plated	1	1
FLBC8514NL	42363	Single gang Frame Kit	Nickel-plated	1	1

Includes PLATED ZINC single gang frame, cover with gasket and a 20A receptacle, low voltage duplex plate, spacers and mounting screws.

TWO GANG COVER / FRAME KITS

FLBC8524MB	42364	Two gang Frame Kit	Brass-plated	1	1
FLBC8524NL	42365	Two gang Frame Kit	Nickel-plated	1	1

Includes PLATED ZINC two gang frame, covers with gaskets and (2) 20A receptacles, low voltage duplex plate, spacers and mounting screws.

THREE GANG COVER / FRAME KITS

FLBC8534MB	42366	Three gang Frame Kit	Brass-plated	1	1
FLBC8534NL	42367	Three gang Frame Kit	Nickel-plated	1	1

Includes PLATED ZINC three gang frame, covers with gaskets and (3) 20A receptacles, low voltage duplex plate, spacers and mounting screws.



FLBC8504MB



FLBC8504NL

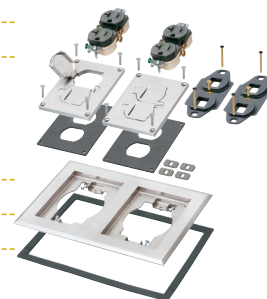

FLBC8524NL
Two-gang Nickel-plated

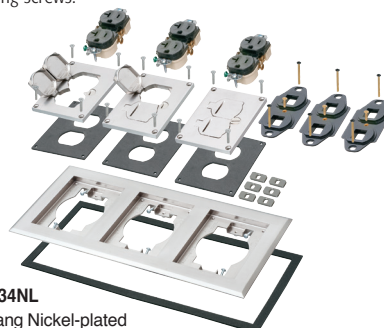

FLBC8534NL
Three-gang Nickel-plated



Arlington®

PLATED COVER KITS

WITH FURNITURE FEED INSERTS

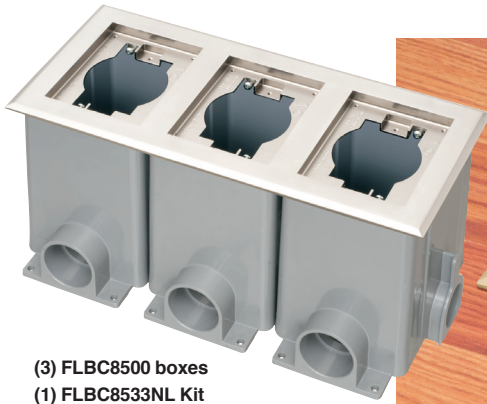

(3) FLBC8500 boxes
(1) FLBC8533NL Kit



(3) FLBC8500 boxes
(1) FLBC8533MB
Plated brass cover/frame kit

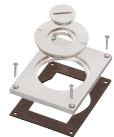

FLBC8503NL
Inserts shown separated



FLBC8505MB

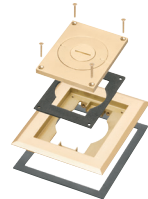

FLBC8513MB



FLBC8515NL

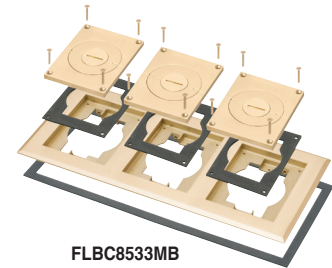

FLBC8533MB

COVER KITS WITH FURNITURE FEED INSERTS

CATALOG NUMBER	UPC/DCI/NAED MFG. #018997	DESCRIPTION COVER INSERT	PLATED ZINC COVER FINISH	UNIT/STD PKG
FLBC8503MB	22943	w/ combo 2" and 3/4" threaded openings	Brass-plated	1/10
FLBC8503NL	22944	w/ combo 2" and 3/4" threaded openings	Nickel-plated	1/10
FLBC8505MB	16301	w/ combo 2" and 1" threaded openings	Brass-plated	1/10
FLBC8505NL	16302	w/ combo 2" and 1" threaded openings	Nickel-plated	1/10

Includes **single gang** gasketed cover w/ combo 2" and 3/4" or 1" threaded openings, (4) mounting screws. Works with Arlington's FLBC8518, FLBC8528 and FLBC8538 recessed cover kit frames.

NEW!

COVER / FRAME KITS with (2) combo 2" and 3/4" threaded openings

FLBC8513MB	20821	Single gang Cover/Frame Kit	Brass-plated	1/1
FLBC8513NL	20822	Single gang Cover/Frame Kit	Nickel-plated	1/1
FLBC8523MB	20823	Two gang Cover/Frame Kit	Brass-plated	1/1
FLBC8523NL	20824	Two gang Cover/Frame Kit	Nickel-plated	1/1
FLBC8533MB	20825	Three gang Cover/Frame Kit	Brass-plated	1/1
FLBC8533NL	20826	Three gang Cover/Frame Kit	Nickel-plated	1/1

Includes frame with gasket, gasketed covers with (2) combo 2" and 3/4" threaded openings in each, and (4) mounting screws.

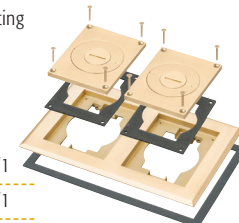

FLBC8523MB

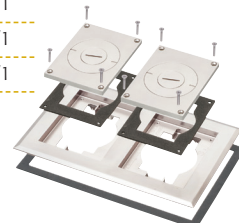

FLBC8523NL

NEW! 1" threaded opening

COVER / FRAME KITS with (2) combo 2" and 1" threaded openings

FLBC8515MB	16303	Single gang Cover/Frame Kit	Brass-plated	1/1
FLBC8515NL	16304	Single gang Cover/Frame Kit	Nickel-plated	1/1
FLBC8525MB	16305	Two gang Cover/Frame Kit	Brass-plated	1/1
FLBC8525NL	16306	Two gang Cover/Frame Kit	Nickel-plated	1/1
FLBC8535MB	16307	Three gang Cover/Frame Kit	Brass-plated	1/1
FLBC8535NL	16308	Three gang Cover/Frame Kit	Nickel-plated	1/1

Includes frame with gasket, gasketed covers with (2) combo 2" and 1" threaded openings in each, and (4) mounting screws.

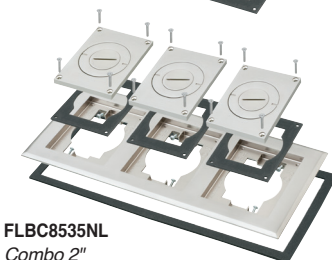
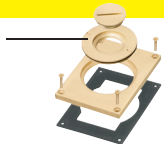

FLBC8535NL
Combo 2" and 1" threaded openings



**MODULAR RECESSED
COVER SHAPE** 

RECESSED COVERS

BRASS PLATED & NICKEL PLATED ZINC

**Recessed
to Reduce
Trip Hazard**

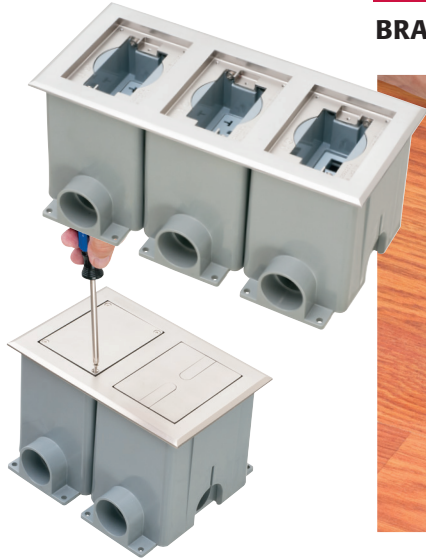

(3) FLBC8500 boxes
(1) FLBC8538MB
Plated brass cover/frame kit

RECESSED COVER KITS FOR FLBC8500, FLBC8502 BOXES

CATALOG NUMBER	UPC/DCI/NAED MFG. #018997	DESCRIPTION	PLATED ZINC COVER FINISH	UNIT PKG	STD PKG
----------------	---------------------------	-------------	--------------------------	----------	---------

FLBC8508MB	22983	Single gang blank, slotted covers	Brass-plated zinc	1	10
FLBC8508NL	22984	Single gang blank, slotted covers	Nickel-plated zinc	1	10

Includes gasketed blank cover with mounting screws, single gang dual slotted in-use cover with removable tabs. Works with Arlington's FLBC8518, FLBC8528 and FLBC8538 recessed cover kit frames.

SINGLE GANG RECESSED COVER / FRAME KITS

FLBC8518MB	22985	Single gang Frame Kit	Brass-plated zinc	1	1
FLBC8518NL	22986	Single gang Frame Kit	Nickel-plated zinc	1	1

Includes single gang recessed frame with gasket and installed 20A receptacle, colored insert, low voltage keystone insert, gasketed blank cover with mounting screws, dual slotted in use cover with removable tabs.

TWO GANG RECESSED COVER / FRAME KITS

FLBC8528MB	22987	Two gang Frame Kit	Brass-plated zinc	1	1
FLBC8528NL	22988	Two gang Frame Kit	Nickel-plated zinc	1	1

Includes two gang recessed frame with gasket, (2) 20A receptacles, colored insert, (2) low voltage keystone inserts, (2) gasketed blank covers with mounting screws, (2) dual slotted in-use covers with removable tabs.

THREE GANG RECESSED COVER / FRAME KITS

FLBC8538MB	22989	Three gang Frame Kit	Brass-plated zinc	1	1
FLBC8538NL	22990	Three gang Frame Kit	Nickel-plated zinc	1	1

Includes three gang recessed frame with gasket, (3) 20A receptacles, colored insert, (3) low voltage keystone inserts, (3) gasketed blank covers with mounting screws, (3) dual slotted in-use covers with removable tabs.

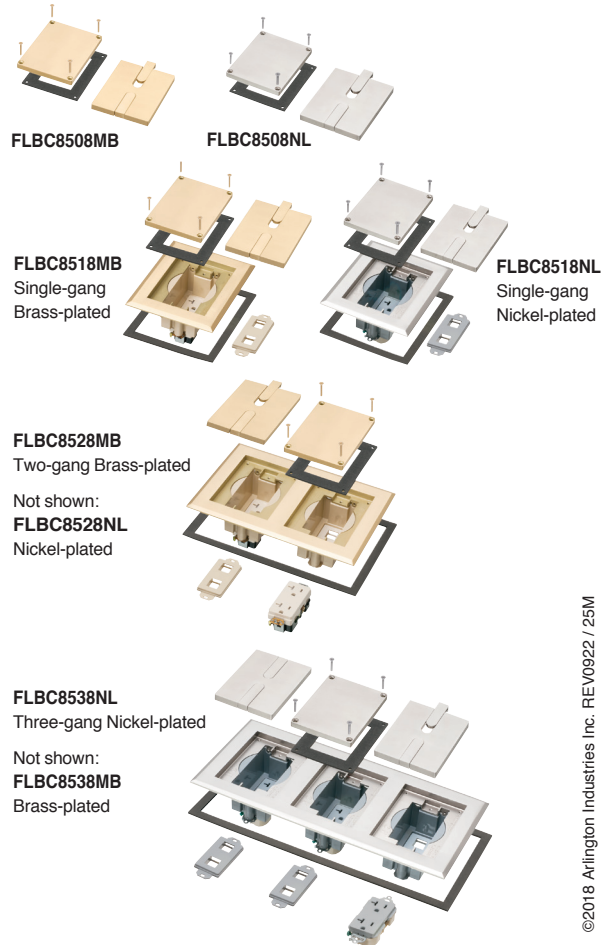

FLBC8508MB

FLBC8508NL

FLBC8518MB
Single-gang
Brass-plated

FLBC8518NL
Single-gang
Nickel-plated

FLBC8528MB
Two-gang Brass-plated

Not shown:
FLBC8528NL
Nickel-plated

FLBC8538NL
Three-gang Nickel-plated

Not shown:
FLBC8538MB
Brass-plated

©2018 Arlington Industries Inc. REV0922 / 25M



Arlington®



Patented.
Other patents pending.

Distributed by

1 Stauffer Industrial Park. Scranton, PA 18517

800.233.4717 • www.aifittings.com • EMAIL sales@aifittings.com