

# SYLVANIA Lamps

## TruWave® Technology Series PAR Family

### TruWave® Technology

TruWave® Technology offers the best alternative to natural light by mimicking the natural light spectrum, all while saving energy.

### Benefits and Features

- Controls blue wavelengths for lower glare and reduced eye strain to improve readability and supports an improved sleep-wake cycle
- Perfect fit where clean light color rendering is needed for seeing realistic, vivid colors without sacrificing light output
- Properly saturates red to make building spaces and flesh tones accurate and vibrant, without oversaturating (which compromises energy efficiency)
- Exceptional color quality without the loss of efficacy typical of most 90+ CRI solutions
- Up to 85 LPW
- 3000K, 3500K and 5000K color temperatures
  - 3500K available in PAR20, PAR30, PAR38
  - 4000K available in PAR20, PAR30, PAR38
- CRI 90+
- Available beam angles: 25° and 40°

### Electrical

- 120VAC
- Power factor >0.90
- Dimmable down to 10%

### Rated Life

- 25,000 hours (L<sub>70</sub>)

### Warranty

- 5 year limited lamp warranty
- NLB Trusted Warranty Program

### Ambient Operating Range

- -4°F to 113°F (-20°C to 45°C)



### Wattage Comparison

PAR Lamp	Traditional Source	Traditional System Wattage	LED System Wattage	Energy Savings
PAR16	Halogen	50	6	\$121
PAR20	Halogen	50	6.5	\$119.63
PAR30	Halogen	75	10.5	\$181.50
PAR38	Halogen	100	11.5	\$211.75
PAR38	Halogen	120	14.5	\$290
PAR38	Halogen	120	15.5	\$291.50

### Certifications and Listings

- cETLus
- RoHS
- CEC Title 20

### Installation

- Suitable for indoor and outdoor dry, damp and wet locations
- 15.5W not for use in enclosed fixtures
- Not for use in emergency light fixtures or exit signs



Catalog #	Type
Project	
Comments	
Prepared by	

Ordering Guide

LED	XX	PARXX	XXXX	DIM	9	XX	TL	XXX	XX	GL	RP
LED	Wattage 6 = 6 Watts 6.5 = 6.5 Watts 10 = 10 Watts 10.5 = 10.5 Watts 11.5 = 11.5 Watts 14.5 = 14.5 Watts 15.5 = 15.5 Watts	Lamp Type PAR16, PAR20, PAR30, PAR30LN, PAR38	Base Blank = E26 GU10 = GU10	DIM = Dimmable	CRI 9 = 90+	Color Temperature 30 = 3000K 35 = 3500K 40 = 4000K 50 = 5000K	TL = Natural with TruWave® Technology	FL = Flood NFL = Narrow Flood	40 = 40° 25 = 25°	GL = Glass	RP = Retail Pack

Ordering Information

Item Number	Ordering Abbreviation	Power (W)	Base Type	Replaces	Input Voltage	Average Life (hrs)	Typical Lumens (lm)	CBCP	CCT	CRI
40930	LED6PAR16DIM930TLFL40GLRP 6/CS 1/SKU	6	E26	50W Halogen	120V	25,000	450	720	3000K	90+
40931	LED6PAR16DIM950TLFL40GLRP 6/CS 1/SKU	6	E26	50W Halogen	120V	25,000	450	720	5000K	90+
40932	LED6PAR16GU10DIM930TLFL40GLRP 6/CS 1/SKU	6	GU10	50W Halogen	120V	25,000	450	720	3000K	90+
40933	LED6PAR16GU10DIM950TLFL40GLRP 6/CS 1/SKU	6	GU10	50W Halogen	120V	25,000	450	720	5000K	90+
40920	LED6.5PAR20DIM930TLFL40GLRP 6/CS 1/SKU	6.5	E26	50W Halogen	120V	25,000	550	1251	3000K	90+
41156	LED6.5PAR20DIM935TLFL40GLRP 6/CS 1/SKU	6.5	E26	50W Halogen	120V	25,000	550	1251	3500K	90+
41119	LED6.5PAR20DIM940TLFL40GLRP 6/CS 1/SKU	6.5	E26	50W Halogen	120V	25,000	550	1251	4000K	90+
40921	LED6.5PAR20DIM950TLFL40GLRP 6/CS 1/SKU	6.5	E26	50W Halogen	120V	25,000	550	1251	5000K	90+
41159	LED10PAR30DIM935TLFL40GLRP 6/CS 1/SKU	10	E26	75W Halogen	120V	25,000	850	1731	3500K	90+
41118	LED10PAR30DIM940TLFL40GLRP 6/CS 1/SKU	10	E26	75W Halogen	120V	25,000	875	1731	4000K	90+
40911	LED10PAR30LNDIM950TLNFL25GLRP 6/CS 1/SKU	10	E26	75W Halogen	120V	25,000	850	4310	5000K	90+
40914	LED10.5PAR30DIM930TLNFL25GLRP 6/CS 1/SKU	10.5	E26	75W Halogen	120V	25,000	875	4310	3000K	90+
40915	LED10.5PAR30DIM950TLNFL25GLRP 6/CS 1/SKU	10.5	E26	75W Halogen	120V	25,000	850	4310	5000K	90+
40916	LED10.5PAR30DIM930TLFL40GLRP 6/CS 1/SKU	10.5	E26	75W Halogen	120V	25,000	850	1731	3000K	90+
40917	LED10.5PAR30DIM950TLFL40GLRP 6/CS 1/SKU	10.5	E26	75W Halogen	120V	25,000	850	1731	5000K	90+
40910	LED10.5PAR30LNDIM930TLNFL25GLRP 6/CS 1/SKU	10.5	E26	75W Halogen	120V	25,000	850	4310	3000K	90+
40912	LED10.5PAR30LNDIM950TLFL40GLRP 6/CS 1/SKU	10.5	E26	75W Halogen	120V	25,000	850	1731	3000K	90+
40913	LED10.5PAR30LNDIM950TLFL40GLRP 6/CS 1/SKU	10.5	E26	75W Halogen	120V	25,000	875	1731	5000K	90+
40899	LED11.5PAR38DIM930TLNFL25GLRP 6/CS 1/SKU	11.5	E26	100W Halogen	120V	25,000	1100	5591	3000K	90+
40900	LED11.5PAR38DIM950TLNFL25GLRP 6/CS 1/SKU	11.5	E26	100W Halogen	120V	25,000	1100	5591	5000K	90+
40901	LED11.5PAR38DIM930TLFL40GLRP 6/CS 1/SKU	11.5	E26	100W Halogen	120V	25,000	1100	1731	3000K	90+
41157	LED11.5PAR38DIM935TLFL40GLRP 6/CS 1/SKU	11.5	E26	100W Halogen	120V	25,000	1100	1731	3500K	90+
41115	LED11.5PAR38DIM940TLFL40GLRP 6/CS 1/SKU	11.5	E26	100W Halogen	120V	25,000	1100	1731	4000K	90+
40902	LED11.5PAR38DIM950TLFL40GLRP 6/CS 1/SKU	11.5	E26	100W Halogen	120V	25,000	1100	1731	5000K	90+
41863	LED14.5PAR38DIM930TLNFL25GLRP 6/CS 1/SKU	14.5	E26	120W Halogen	120V	25,000	1350	4241	3000K	90+
41864	LED14.5PAR38DIM950TLNFL25GLRP 6/CS 1/SKU	14.5	E26	120W Halogen	120V	25,000	1350	4241	5000K	90+
41865	LED14.5PAR38DIM930TLFL40GLRP 6/CS 1/SKU	14.5	E26	120W Halogen	120V	25,000	1350	1758	3000K	90+
41866	LED14.5PAR38DIM950TLFL40GLRP 6/CS 1/SKU	14.5	E26	120W Halogen	120V	25,000	1350	1758	5000K	90+
41867	LED14.5PAR38DIM940TLFL40GLRP 6/CS 1/SKU	14.5	E26	120W Halogen	120V	25,000	1350	1758	4000K	90+
41868	LED14.5PAR38DIM935TLFL40GLRP 6/CS 1/SKU	14.5	E26	120W Halogen	120V	25,000	1350	1758	3500K	90+
41116	LED15.5PAR38DIM940TLFL40GLRP 6/CS 1/SKU	15.5	E26	120W Halogen	120V	25,000	1250	2377	4000K	90+

Physical Information

	(A) Height inches (mm)	(B) Diameter inches (mm)
PAR16 GU10	2.05 (52)	1.97 (50)
PAR16 E26	2.76 (70)	1.97 (50)
PAR20	3.19 (81)	2.48 (63)
PAR30	3.54 (90)	3.74 (95)
PAR30LN	4.41 (112)	3.74 (95)
PAR38	5.12 (130)	4.72 (120)

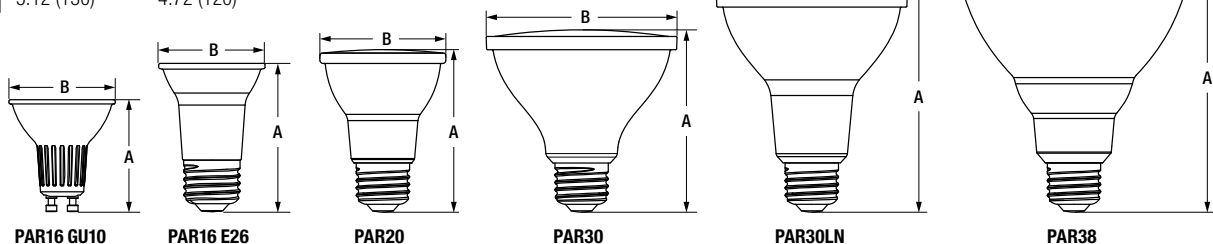

# Color Quality Comparison

CCT	Spectral Power Distribution	TM-30-18 Fidelity Index
3000K	<p>Graph showing Spectral Power Distribution for 3000K. The x-axis is Wavelength (nm) from 380 to 780. The y-axis is Intensity (mW/nm) from 0.00E+00 to 2.50E-02. Three curves are shown: TruWave 3000K Ra90 (solid red), CRI80 3000K (solid orange), and 3000K BBC (dashed grey).</p>	<p>Two bar charts showing Color Sample Fidelity, <math>R_{f,CES}</math>, vs. CES Color (1-97). The top chart is for TruWave LED - Optimized Color Fidelity (Ra90) and the bottom chart is for 80 CRI LED. Both show high fidelity across all colors.</p>
3500K	<p>Graph showing Spectral Power Distribution for 3500K. The x-axis is Wavelength (nm) from 380 to 780. The y-axis is Intensity (mW/nm) from 0.00E+00 to 2.00E-02. Three curves are shown: TruWave 3500K Ra90 (solid red), CRI80 3500K (solid orange), and 3500K BBC (dashed grey).</p>	<p>Two bar charts showing Color Sample Fidelity, <math>R_{f,CES}</math>, vs. CES Color (1-97). The top chart is for TruWave LED - Optimized Color Fidelity (Ra90) and the bottom chart is for 80 CRI LED. Both show high fidelity across all colors.</p>
4000K	<p>Graph showing Spectral Power Distribution for TruWave, 4000K Scaled to 800 lm. The x-axis is Wavelength (nm) from 380 to 730. The y-axis is Intensity (mW/nm) from 0 to 20. Three curves are shown: TruWave Technology (solid red), CRI80 Bulb (solid orange), and Black Body 4000K (dashed grey).</p>	<p>Two bar charts showing Color Sample Fidelity, <math>R_{f,CES}</math>, vs. CES Color (1-97). The top chart is for TruWave LED - Optimized Color Fidelity (Ra90) with <math>R_f = 91</math> and the bottom chart is for 80 CRI LED with <math>R_f = 85</math>. Both show high fidelity across all colors.</p>
5000K	<p>Graph showing Spectral Power Distribution for TruWave, 5000K Scaled to 800 lm. The x-axis is Wavelength (nm) from 380 to 740. The y-axis is Intensity (mW/nm) from 0 to 20. Three curves are shown: TruWave Technology (solid red), CRI80 Bulb (solid orange), and Daylight D50 (dashed grey).</p>	<p>Two bar charts showing Color Sample Fidelity, <math>R_{f,CES}</math>, vs. CES Color (1-97). The top chart is for TruWave LED - Optimized Color Fidelity (Ra90) with <math>R_f = 93</math> and the bottom chart is for 80 CRI LED with <math>R_f = 86</math>. Both show high fidelity across all colors.</p>

LEDVANCE LLC  
181 Ballardvale Street, Suite 203  
Wilmington, MA 01887 USA  
Phone 1-800-LIGHTBULB (1-800-544-4828)  
[www.ledvanceUS.com](http://www.ledvanceUS.com)

SYLVANIA and LEDVANCE are registered trademarks.  
All other trademarks are those of their respective owners.  
Licensee of product trademark SYLVANIA in general lighting.  
Specifications subject to change without notice.



SCAN TO FOLLOW US  
ON SOCIAL MEDIA

© 2024 LEDVANCE LLC



# SYLVANIA Lamps

## TruWave® Technology Series PAR Family

### TruWave® Technology

TruWave® Technology offers the best alternative to natural light by mimicking the natural light spectrum, all while saving energy.

### Benefits and Features

- Controls blue wavelengths for lower glare and reduced eye strain to improve readability and supports an improved sleep-wake cycle
- Perfect fit where clean light color rendering is needed for seeing realistic, vivid colors without sacrificing light output
- Properly saturates red to make building spaces and flesh tones accurate and vibrant, without oversaturating (which compromises energy efficiency)
- Exceptional color quality without the loss of efficacy typical of most 90+ CRI solutions
- Up to 85 LPW
- 3000K, 3500K and 5000K color temperatures
  - 3500K available in PAR20, PAR30, PAR38
  - 4000K available in PAR20, PAR30, PAR38
- CRI 90+
- Available beam angles: 25° and 40°

### Electrical

- 120VAC
- Power factor >0.90
- Dimmable down to 10%

### Rated Life

- 25,000 hours (L<sub>70</sub>)

### Warranty

- 5 year limited lamp warranty
- NLB Trusted Warranty Program

### Ambient Operating Range

- -4°F to 113°F (-20°C to 45°C)



### Wattage Comparison

PAR Lamp	Traditional Source	Traditional System Wattage	LED System Wattage	Energy Savings
PAR16	Halogen	50	6	\$121
PAR20	Halogen	50	6.5	\$119.63
PAR30	Halogen	75	10.5	\$181.50
PAR38	Halogen	100	11.5	\$211.75
PAR38	Halogen	120	14.5	\$290
PAR38	Halogen	120	15.5	\$291.50

### Certifications and Listings

- cETLus
- RoHS
- CEC Title 20

### Installation

- Suitable for indoor and outdoor dry, damp and wet locations
- 15.5W not for use in enclosed fixtures
- Not for use in emergency light fixtures or exit signs



Catalog #	Type
Project	
Comments	
Prepared by	

Ordering Guide

LED	XX	PARXX	XXXX	DIM	9	XX	TL	XXX	XX	GL	RP
LED	Wattage 6 = 6 Watts 6.5 = 6.5 Watts 10 = 10 Watts 10.5 = 10.5 Watts 11.5 = 11.5 Watts 14.5 = 14.5 Watts 15.5 = 15.5 Watts	Lamp Type PAR16, PAR20, PAR30, PAR30LN, PAR38	Base Blank = E26 GU10 = GU10	DIM = Dimmable	CRI 9 = 90+	Color Temperature 30 = 3000K 35 = 3500K 40 = 4000K 50 = 5000K	TL = Natural with TruWave® Technology	FL = Flood NFL = Narrow Flood	40 = 40° 25 = 25°	GL = Glass	RP = Retail Pack

Ordering Information

Item Number	Ordering Abbreviation	Power (W)	Base Type	Replaces	Input Voltage	Average Life (hrs)	Typical Lumens (lm)	CBCP	CCT	CRI
40930	LED6PAR16DIM930TLFL40GLRP 6/CS 1/SKU	6	E26	50W Halogen	120V	25,000	450	720	3000K	90+
40931	LED6PAR16DIM950TLFL40GLRP 6/CS 1/SKU	6	E26	50W Halogen	120V	25,000	450	720	5000K	90+
40932	LED6PAR16GU10DIM930TLFL40GLRP 6/CS 1/SKU	6	GU10	50W Halogen	120V	25,000	450	720	3000K	90+
40933	LED6PAR16GU10DIM950TLFL40GLRP 6/CS 1/SKU	6	GU10	50W Halogen	120V	25,000	450	720	5000K	90+
40920	LED6.5PAR20DIM930TLFL40GLRP 6/CS 1/SKU	6.5	E26	50W Halogen	120V	25,000	550	1251	3000K	90+
41156	LED6.5PAR20DIM935TLFL40GLRP 6/CS 1/SKU	6.5	E26	50W Halogen	120V	25,000	550	1251	3500K	90+
41119	LED6.5PAR20DIM940TLFL40GLRP 6/CS 1/SKU	6.5	E26	50W Halogen	120V	25,000	550	1251	4000K	90+
40921	LED6.5PAR20DIM950TLFL40GLRP 6/CS 1/SKU	6.5	E26	50W Halogen	120V	25,000	550	1251	5000K	90+
41159	LED10PAR30DIM935TLFL40GLRP 6/CS 1/SKU	10	E26	75W Halogen	120V	25,000	850	1731	3500K	90+
41118	LED10PAR30DIM940TLFL40GLRP 6/CS 1/SKU	10	E26	75W Halogen	120V	25,000	875	1731	4000K	90+
40911	LED10PAR30LNDIM950TLNFL25GLRP 6/CS 1/SKU	10	E26	75W Halogen	120V	25,000	850	4310	5000K	90+
40914	LED10.5PAR30DIM930TLNFL25GLRP 6/CS 1/SKU	10.5	E26	75W Halogen	120V	25,000	875	4310	3000K	90+
40915	LED10.5PAR30DIM950TLNFL25GLRP 6/CS 1/SKU	10.5	E26	75W Halogen	120V	25,000	850	4310	5000K	90+
40916	LED10.5PAR30DIM930TLFL40GLRP 6/CS 1/SKU	10.5	E26	75W Halogen	120V	25,000	850	1731	3000K	90+
40917	LED10.5PAR30DIM950TLFL40GLRP 6/CS 1/SKU	10.5	E26	75W Halogen	120V	25,000	850	1731	5000K	90+
40910	LED10.5PAR30LNDIM930TLNFL25GLRP 6/CS 1/SKU	10.5	E26	75W Halogen	120V	25,000	850	4310	3000K	90+
40912	LED10.5PAR30LNDIM930TLFL40GLRP 6/CS 1/SKU	10.5	E26	75W Halogen	120V	25,000	850	1731	3000K	90+
40913	LED10.5PAR30LNDIM950TLFL40GLRP 6/CS 1/SKU	10.5	E26	75W Halogen	120V	25,000	875	1731	5000K	90+
40899	LED11.5PAR38DIM930TLNFL25GLRP 6/CS 1/SKU	11.5	E26	100W Halogen	120V	25,000	1100	5591	3000K	90+
40900	LED11.5PAR38DIM950TLNFL25GLRP 6/CS 1/SKU	11.5	E26	100W Halogen	120V	25,000	1100	5591	5000K	90+
40901	LED11.5PAR38DIM930TLFL40GLRP 6/CS 1/SKU	11.5	E26	100W Halogen	120V	25,000	1100	1731	3000K	90+
41157	LED11.5PAR38DIM935TLFL40GLRP 6/CS 1/SKU	11.5	E26	100W Halogen	120V	25,000	1100	1731	3500K	90+
41115	LED11.5PAR38DIM940TLFL40GLRP 6/CS 1/SKU	11.5	E26	100W Halogen	120V	25,000	1100	1731	4000K	90+
40902	LED11.5PAR38DIM950TLFL40GLRP 6/CS 1/SKU	11.5	E26	100W Halogen	120V	25,000	1100	1731	5000K	90+
41863	LED14.5PAR38DIM930TLNFL25GLRP 6/CS 1/SKU	14.5	E26	120W Halogen	120V	25,000	1350	4241	3000K	90+
41864	LED14.5PAR38DIM950TLNFL25GLRP 6/CS 1/SKU	14.5	E26	120W Halogen	120V	25,000	1350	4241	5000K	90+
41865	LED14.5PAR38DIM930TLFL40GLRP 6/CS 1/SKU	14.5	E26	120W Halogen	120V	25,000	1350	1758	3000K	90+
41866	LED14.5PAR38DIM950TLFL40GLRP 6/CS 1/SKU	14.5	E26	120W Halogen	120V	25,000	1350	1758	5000K	90+
41867	LED14.5PAR38DIM940TLFL40GLRP 6/CS 1/SKU	14.5	E26	120W Halogen	120V	25,000	1350	1758	4000K	90+
41868	LED14.5PAR38DIM935TLFL40GLRP 6/CS 1/SKU	14.5	E26	120W Halogen	120V	25,000	1350	1758	3500K	90+
41116	LED15.5PAR38DIM940TLFL40GLRP 6/CS 1/SKU	15.5	E26	120W Halogen	120V	25,000	1250	2377	4000K	90+

Physical Information

	(A) Height inches (mm)	(B) Diameter inches (mm)
PAR16 GU10	2.05 (52)	1.97 (50)
PAR16 E26	2.76 (70)	1.97 (50)
PAR20	3.19 (81)	2.48 (63)
PAR30	3.54 (90)	3.74 (95)
PAR30LN	4.41 (112)	3.74 (95)
PAR38	5.12 (130)	4.72 (120)

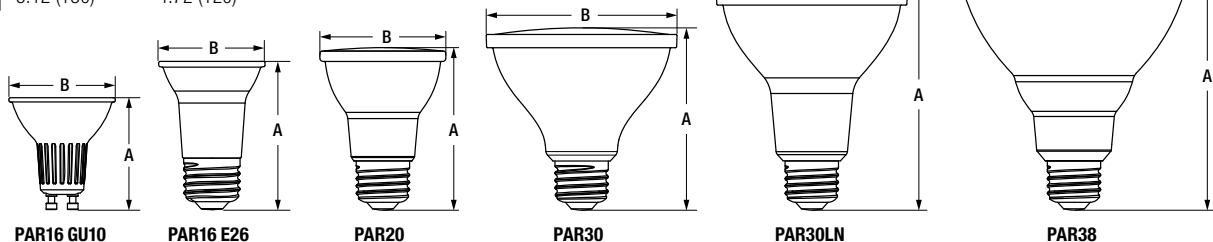

# Color Quality Comparison

CCT	Spectral Power Distribution	TM-30-18 Fidelity Index
3000K		
3500K		
4000K		
5000K		

LEDVANCE LLC  
181 Ballardvale Street, Suite 203  
Wilmington, MA 01887 USA  
Phone 1-800-LIGHTBULB (1-800-544-4828)  
[www.ledvanceUS.com](http://www.ledvanceUS.com)

SYLVANIA and LEDVANCE are registered trademarks.  
All other trademarks are those of their respective owners.  
Licensee of product trademark SYLVANIA in general lighting.  
Specifications subject to change without notice.



SCAN TO FOLLOW US  
ON SOCIAL MEDIA

© 2024 LEDVANCE LLC

