



MULTI-FUNCTION CLIP, 1/4"-3/8" ROD, #12-#8 WIRE, 1/8"-7/16" FLANGE, 1/4" HOLE

CATALOG NUMBER

4Z34



CERTIFICATIONS



FEATURES

Provides attachment of electrical boxes

Supports #10-24 and 1/4-20 (M6) threaded bridle rings

Instills more confidence installing conduit, MC/AC, and low voltage applications

PRODUCT ATTRIBUTES

Material: Spring Steel

Finish: nVent CADDY Armour

Rod Size (RS): 1/4";5/16";3/8"

Wire Size: #12 - #8

Flange Thickness (FT): 1/8" - 3/8"

Hole Size (HS): 1/4"

Screw Included: No

Static Load 1 (F1): 25 lb

Static Load 2 (F2): 20 lb

ADDITIONAL PRODUCT DETAILS

NEC® 300.11 requires dedicated drop wire/rod and EC311.

4Z parts installed on 3/8" (M10) smooth rod in the F2 direction has a Static Load Rating of 15 lb (67 N).

DIAGRAMS

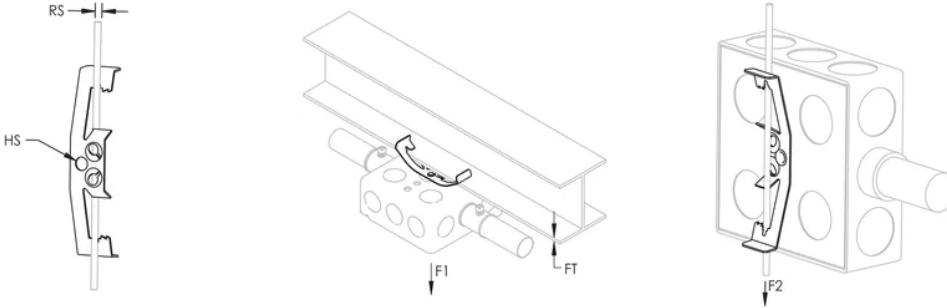

WARNING

nVent products shall be installed and used only as indicated in nVent's product instruction sheets and training materials. Instruction sheets are available at www.nvent.com and from your nVent customer service representative. Improper installation, misuse, misapplication or other failure to completely follow nVent's instructions and warnings may cause product malfunction, property damage, serious bodily injury and death and/or void your warranty.

North America

+1.800.753.9221
Option 1 – Customer Care
Option 2 – Technical Support

Europe

Netherlands:
+31 800-0200135
France:
+33 800 901 793

Europe

Germany:
800 1890272
Other Countries:
+31 13 5835404

APAC

Shanghai:
+ 86 21 2412 1618/19
Sydney:
+61 2 9751 8500



Our powerful portfolio of brands:
nVent.com **CADDY ERICO HOFFMAN RAYCHEM SCHROFF**
TRACER