

Straight Blade Plugs & Connectors for Any Application

Arrow Hart's extensive offering of straight blade plugs and connectors cover the full range of Hospital, Industrial and Commercial Specification Grades for applications where quality and durability are critical

Features & Benefits**Hospital Specification Grade Plugs & Connectors**

Built to meet and exceed UL Federal Specification and Hospital Grade testing, Arrow Hart's Hospital Grade Plugs and Connectors assure reliable performance in the most demanding healthcare applications.

**Industrial Specification Grade Plugs, Connectors, Flanged Inlet & Flanged Outlets**

With a variety of styles including SafetyGrip, AutoGrip and QuickGrip, these devices are designed to install quickly and easily and provide reliable performance in tough industrial environments.

**Commercial Specification Grade Straight Blade Plugs & Connectors**

Designed for light commercial applications, where ease-of-use, value and quality are critical.

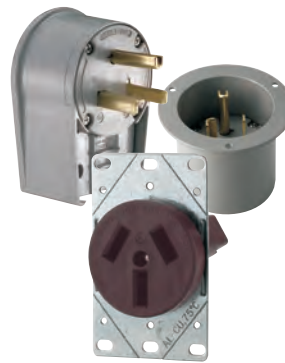
**Specification Grade Straight Blade Power Devices**

Heavy duty design and construction make Arrow Hart power devices ideal for any high amperage industrial or commercial power connectivity application.

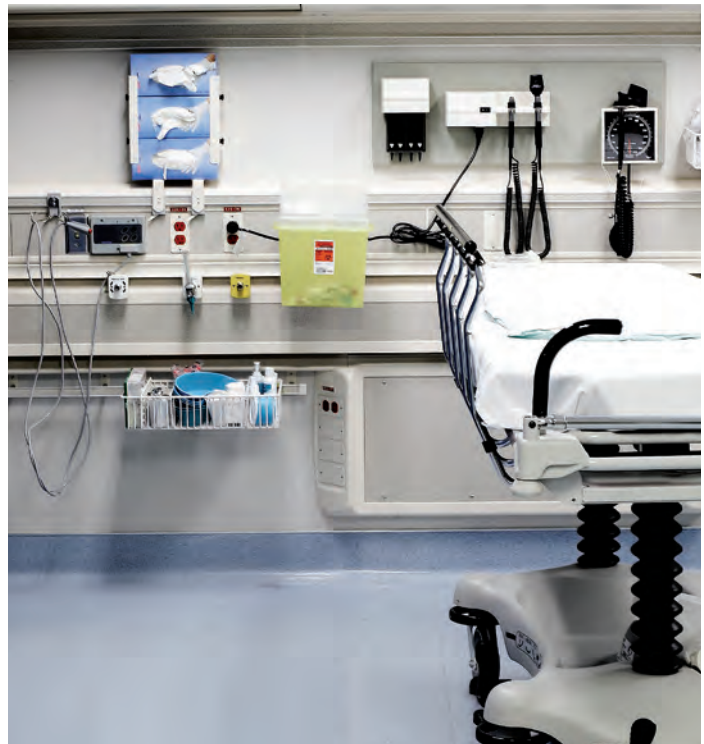
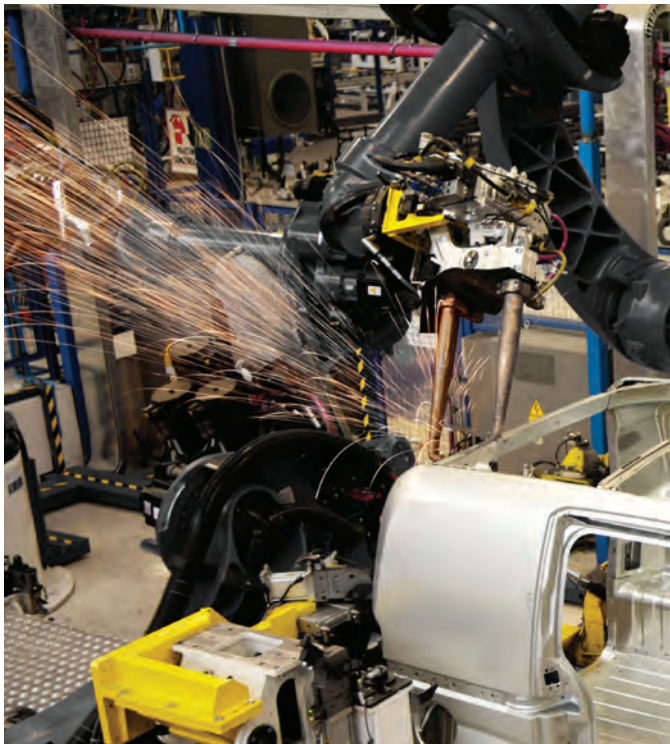

SafetyGrip Hospital and Industrial Grade Plugs & Connectors

1 Rugged nylon body resists impact and exposure to chemicals

2 Neoprene gasket seals around cord for added terminal protection from external elements

3 Dual range cord grip provides positive cord gripping while limiting strain on conductors

4 Rating information clearly marked on face of device

5 Wiring chamber provides generous space for wiring

6 Textured surface allows for easy grip and handling

Back Body

Front Body



SafetyGrip Hospital Grade devices exceed Federal Spec. and Hospital Grade testing for use in demanding healthcare environments



Clear terminal cover allows for easy inspection of conductors and terminations



Retained quick drive assembly screws speed installation



Four position angled plug option is ideal for applications requiring power cord to lay close to walls and floors

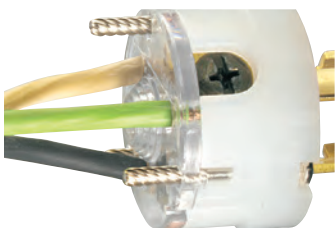

Tapered, individual wire pockets guide stranded wire into contact area for ease of installation

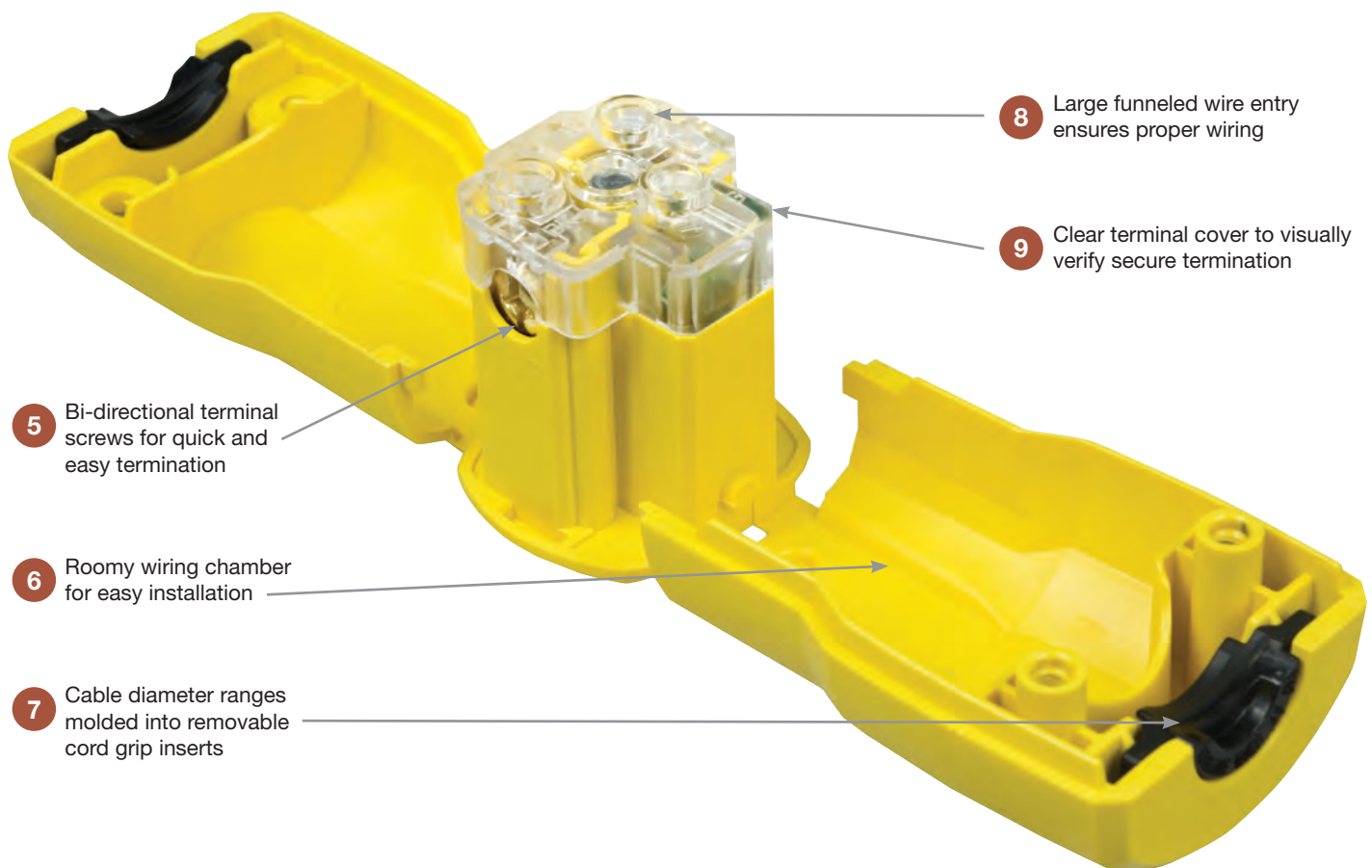
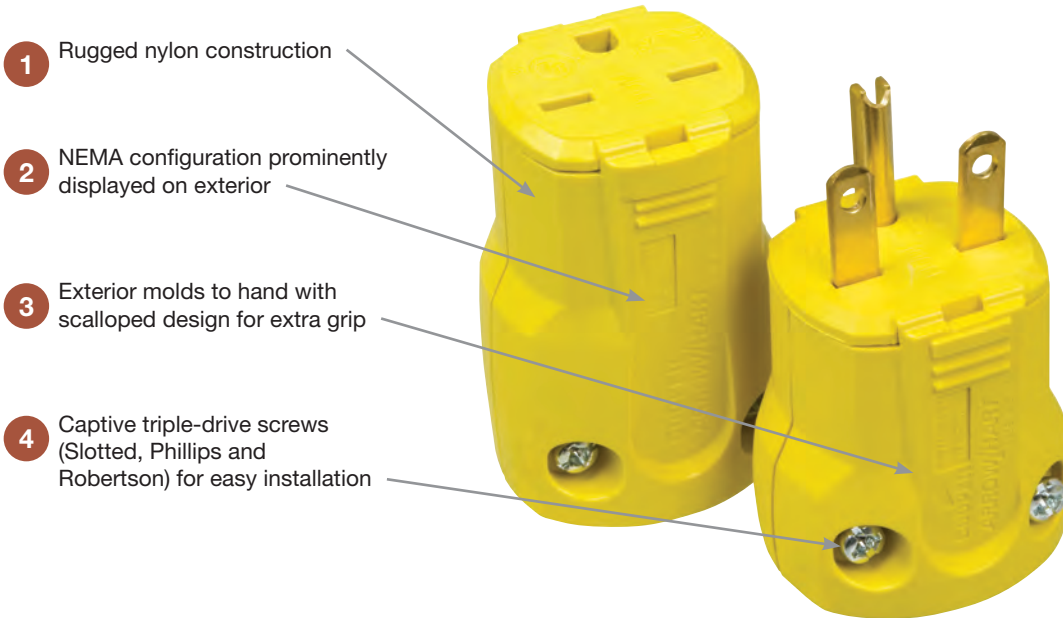

Multiple-head drive screws provide versatility for ease of use

QuickGrip Hospital and Industrial Grade Plugs & Connectors

Specifications and availability are subject to change without notice.

AutoGrip Hospital and Industrial Grade Plugs & Connectors

1 Smooth, tapered body reduces snagging and provides easy handling

2 Neoprene gasket seals around cord for added terminal protection from external elements

3 Rugged nylon body resists impact and exposure to chemicals

4 Single piece grounding contacts for superior continuity

5 AutoGrip clamp design secures cord during assembly, reducing installation time

Back Body

Front Body



AutoGrip Hospital Grade devices exceed Federal Spec. and Hospital Grade testing for use in demanding healthcare environments



Unique clamp design secures cord during assembly, reducing installation time



Retained quick drive assembly screws speed installation



Multiple-head drive screws provide versatility for ease of use



Tapered, individual wire pockets guide stranded wire into contact area for ease of installation

Specifications and availability are subject to change without notice.

**Industrial Grade
Straight Blade Devices**

2-Pole, 3-Wire Grounding
15A, 125V/AC
NEMA 5-15



5-15P



5-15R

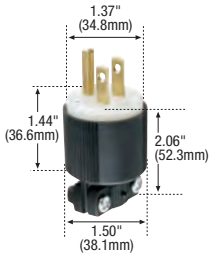

6266



AH5969BK



5278C



5278

Industrial Grade Plugs & Connectors



Rating A	V/AC	NEMA	Description	Cord Diameter	Color	Plug Catalog No.	Connector Catalog No.	
15	125	5-15	SafetyGrip Straight Body	0.33-0.66" (8.3-16.7mm)	BK & W	□ 6266	□ 6269	•
			SafetyGrip Straight Body	0.33-0.66" (8.3-16.7mm)	BK	□ 6266BLK	□ 6269BLK	•
			SafetyGrip Angled Body	0.33-0.66" (8.3-16.7mm)	BK & W	□ 6265	—	•
			QuickGrip Straight Body	0.22-0.66" (5.6-16.7mm)	BK	□ AH5965BK	□ AH5969BK	
			QuickGrip Straight Body	0.22-0.66" (5.6-16.7mm)	Y	□ AH5965Y	□ AH5969Y	
			AutoGrip Straight Body	0.33-0.66" (8.3-16.7mm)	BK & W	□ 5266N	□ 5269N	•

Industrial Grade Flanged Inlets & Outlets



Rating A	V/AC	NEMA	Description	Color	Plug Catalog No.	Connector Catalog No.	
15	125	5-15	Nylon Construction, Back Wire	BK & W	□ 5278C†	□ 5279C*	•
			Metal Shell, Back Wire	Steel	□ 5278	—	•
			Metal Shell, Back Wire	Steel	—	□ 5246*	

* UL Listed Only, † Fed Spec Certified

Industrial Grade Dimensional Information: B-14-B-15

Specification Information:
SafetyGrip Industrial Plugs & Connectors: B-22
QuickGrip Plugs & Connectors: B-22
AutoGrip Industrial Plugs & Connectors: B-22
Industrial Flanged Inlets & Flanged Outlets: B-23

Color Information:

BK (Black), C (Clear), RN (Orange), W (White), Y (Yellow)



Specifications and availability are subject to change without notice.

Indicates NAFTA Compliant - Page R-30

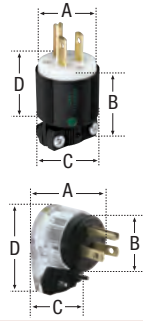
SafetyGrip Plugs

Family	A	B	C	D	Cord Diameter
Hospital Grade	1.37" (34.8mm)	2.06" (52.3mm)	1.50" (38.1mm)	1.44" (36.6mm)	0.33-0.66" (8.3-16.7mm)
Hospital Grade Angled	1.46" (37.1mm)	1.50" (38.1mm)	1.28" (32.5mm)	2.06" (52.3mm)	0.33-0.66" (8.3-16.7mm)
Industrial Grade	1.37" (34.8mm)	2.06" (52.3mm)	1.50" (38.1mm)	1.44" (36.6mm)	0.33-0.66" (8.3-16.7mm)
Industrial Grade Angled	1.28" (32.5mm)	1.46" (37.1mm)	1.50" (38.1mm)	2.06" (52.3mm)	0.33-0.66" (8.3-16.7mm)
Industrial Grade NEMA 7-20, 10-20 & 18-20	1.78" (45.2mm)	2.34" (59.4mm)	2.13" (54.1mm)	–	0.38"-1.00" (9.6-25.4mm)

SafetyGrip Connectors

Family	A	B	C	D	Cord Diameter
Hospital Grade	1.37" (34.8mm)	2.77" (70.4mm)	1.50" (38.1mm)	0.87" (22.1mm)	0.33-0.66" (8.3-16.7mm)
Industrial Grade	1.37" (34.8mm)	2.77" (70.4mm)	1.50" (38.1mm)	0.87" (22.1mm)	0.33-0.66" (8.3-16.7mm)

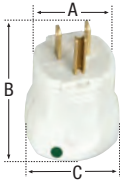
QuickGrip Plugs

Family	A	B	C	Cord Diameter
Hospital Grade	1.47" (37.3mm)	2.77" (70.4mm)	1.67" (42.4mm)	0.22-0.66" (5.6-16.7mm)
Industrial Grade	1.47" (37.3mm)	2.77" (70.4mm)	1.67" (42.4mm)	0.22-0.66" (5.6-16.7mm)

QuickGrip Connectors

Family	A	B	C	Cord Diameter
Industrial Grade	1.46" (37.1mm)	2.59" (65.8mm)	1.67" (42.4mm)	0.22-0.66" (5.6-16.7mm)

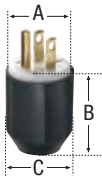
AutoGrip Plugs

Family	A	B	C	Cord Diameter
Hospital Grade	1.38" (34.9mm)	1.83" (46.5mm)	1.52" (38.6mm)	0.33-0.66" (8.3-16.7mm)
Industrial Grade	1.37" (34.8mm)	1.83" (46.5mm)	1.51" (38.4mm)	0.33-0.66" (8.3-16.7mm)

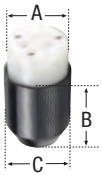
AutoGrip Connectors

Family	A	B	C	Cord Diameter
Hospital Grade	1.38" (34.9mm)	1.83" (46.5mm)	1.52" (38.6mm)	0.33-0.66" (8.3-16.7mm)
Industrial Grade	1.37" (34.8mm)	1.83" (46.5mm)	1.51" (38.4mm)	0.33-0.66" (8.3-16.7mm)

Specifications and availability are subject to change without notice.

Nylon Shell Flanged Inlets

Family	A	B	C
Industrial Grade	2.56" (65.0mm)	1.84" (46.7mm)	1.71" (43.4mm)



Nylon Shell Flanged Outlets

Family	A	B	C
Industrial Grade	2.56" (65.0mm)	1.84" (46.7mm)	1.71" (43.4mm)



Metal Shell Flanged Inlets

Family	A	B	C
Industrial Grade	2.00" (50.8mm)	1.43" (36.3mm)	1.62" (41.1mm)

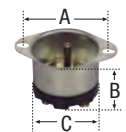

Metal Shell Flanged Outlets

Family	A	B	C
Industrial Grade	2.06" (52.3mm)	1.50" (38.1mm)	1.09" (27.7mm)



Commercial Plugs

Family	A	B	C	D	Cord Diameter
Commercial Grade	1.65" (41.9mm)	1.54" (39.1mm)	-	-	0.25-0.66" (6.4-16.6mm)
Commercial Grade Angled	1.25" (31.8mm)	1.42" (36.1mm)	1.50" (38.1mm)	1.95" (49.5mm)	0.25-0.66" (6.4-16.6mm)

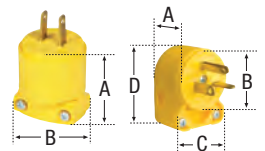

Commercial Connectors

Family	A	B	C	Cord Diameter
Commercial Grade	1.35" (34.3mm)	2.61" (66.3mm)	1.54" (39.1mm)	0.25-0.66" (6.4-16.6mm)

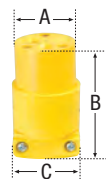

Specifications and availability are subject to change without notice.

**Industrial Grade
Plugs & Connectors**

2-Pole, 3-Wire Grounding
 3-Pole, 3-Wire Non-Grounding
 4-Pole, 4-Wire Non-Grounding

Device Type	Industrial Grade SafetyGrip Plugs & Connectors, Straight Blade	Industrial Grade AutoGrip Plugs & Connectors, Straight Blade	Industrial Grade QuickGrip Plugs & Connectors, Straight Blade	
Wiring Type	Back Wire	Back Wire	Back Wire	
Testing & Code Compliance	<ul style="list-style-type: none"> cULus Listed to UL498, file no. E3663 Complies with Federal Spec. WC-596F CSA certified to C22.2, no. 42-99 file no. 7087 (6221-02) 7251N: NOM certified 	<ul style="list-style-type: none"> Listed to UL498, file no. E3663 UL verified to Fed Spec WC-596F except cat. no. 5266AN CSA certified to C22.2, no. 42-99 file no. 2081 (6221-02) 	<ul style="list-style-type: none"> cULus Listed to UL498, file no. E15012 UL verified to Federal Spec. WC-596G 	
	Flammability	Meets UL94 requirements, V2 rated	Meets UL94 requirements, V2 rated	Meets UL94 requirements, V2 rated
	Temperature Rating	-40°C to 75°C (-40°F to 167°F)	-40°C to 75°C (-40°F to 167°F)	-40°C to 75°C (-40°F to 167°F)
	Dielectric Voltage	Twice the device rating + 1000V per UL498	Twice the device rating + 1000V per UL498	Twice the device rating + 1000V per UL498
Specifications: Electrical	Current Interrupting	Yes, at full-rated current	Yes, at full-rated current	Yes, at full-rated current
	Temperature Rise	Max. 30°C (86°F) after 200 cycles of overload @ 200% of rated current (DC)	Max. 30°C (86°F) after 50 cycles of overload @ 150% of rated current (DC)	Max. 30°C (86°F) after 100 cycles of overload @ 150% of rated current (DC)
	Terminal Accommodation	#16 - #12 AWG, except 7624N, 9151N, 7251N: #18 - #10 AWG	#18 - #12 AWG	#18 - #12 AWG
Specifications: Mechanical	Voltage Ratings	Permanently marked on device	Permanently marked on device	Permanently marked on device
	Materials:	Plug/Connector Outer Shell	Nylon	Nylon
Interior Body		Nylon	Nylon	N/A
Terminal Retainer		Polycarbonate	Polycarbonate	Polycarbonate
Blades		0.065" thick brass	0.065" thick brass	0.060" thick brass
Line Contacts		0.031" thick brass	0.031" thick brass	0.030" thick brass
Terminal Clamps		Steel, zinc plated	Steel, zinc plated	Steel, zinc plated
Terminal Screws		#8-32 brass, nickel plated	#8-32 brass, nickel plated	Steel, brass plated (hot) and zinc plated (neutral)
Ground Contact		0.041" thick brass	0.041" thick bronze	Brass
Ground Screw		#8-32 brass, zinc plated, green	#8-32 brass, green	Steel, zinc plated, green
Assembly/ Mounting Screws		Steel, zinc plated	Steel, zinc plated	Steel, zinc plated
Cord Clamp		Nylon	Polypropylene	Nylon
Cord Clamp Screws		Steel, zinc plated	N/A	N/A
Gasket/Dust Shield		Neoprene	Neoprene	N/A

Specifications and availability are subject to change without notice.

Industrial Grade Flanged Inlets & Flanged Outlets

2-Pole, 3-Wire Grounding
 15A, 125V/AC; 15A, 250V/AC; 20A, 125V/AC; 20A, 250V/AC
 NEMA 5-15, 6-15, 5-20, 6-20

Device Type	Industrial Grade Flanged Inlets, Straight Blade	Industrial Grade Flanged Outlets, Straight Blade
Wiring Type	Side Wire	Side Wire
Testing & Code Compliance	<ul style="list-style-type: none"> Listed to UL498, file no. E3663 	<ul style="list-style-type: none"> Listed to UL498, file no. E2369
	<ul style="list-style-type: none"> cUL Listed to CSA C22.2, no. 42-M1999 	<ul style="list-style-type: none"> CSA certified to C22.2, no. 42-99 & 182.3-M1987 file no. 7087 (6233-01)
	<ul style="list-style-type: none"> 5278C, 5678C: also NOM certified 	
Specifications: Environmental	Flammability	Meets UL94 requirements, V2 rated
	Temperature Rating	-40°C to 105°C (-40°F to 221°F)
Specifications: Electrical	Dielectric Voltage	Twice the device rating + 1000V per UL498
	Current Interrupting	Yes, at full-rated current
	Temperature Rise	Max. 30°C (86°F) after 100 cycles of overload @ 150% of rated current (DC)
Specifications: Mechanical	Terminal Accommodation	#14 AWG
	Voltage Ratings	Permanently marked on device
Materials:	Outer Shell	Nylon, except 5278C: steel
	Interior Body	Lexan, except 5278C: urea
	Terminal Retainer	Lexan, except 5278C: urea
	Blades	0.062" thick brass, except 5278C: 0.040"
	Line Contacts	0.062" thick brass
	Terminal Clamps	Brass
	Terminal Screws	#8-32 steel, brass plated (hot) or nickel plated (neutral), except 5278C: #6-32
	Ground Screw	#8-32 brass, zinc plated, green, except 5278C: #6-40
Assembly Screws/Rivets	Steel screws, except 5278C: steel rivets, zinc plated	

Specifications and availability are subject to change without notice.

Straight Blade Plugs & Connectors for Any Application

Arrow Hart's extensive offering of straight blade plugs and connectors cover the full range of Hospital, Industrial and Commercial Specification Grades for applications where quality and durability are critical

Features & Benefits**Hospital Specification Grade Plugs & Connectors**

Built to meet and exceed UL Federal Specification and Hospital Grade testing, Arrow Hart's Hospital Grade Plugs and Connectors assure reliable performance in the most demanding healthcare applications.

**Industrial Specification Grade Plugs, Connectors, Flanged Inlet & Flanged Outlets**

With a variety of styles including SafetyGrip, AutoGrip and QuickGrip, these devices are designed to install quickly and easily and provide reliable performance in tough industrial environments.

**Commercial Specification Grade Straight Blade Plugs & Connectors**

Designed for light commercial applications, where ease-of-use, value and quality are critical.

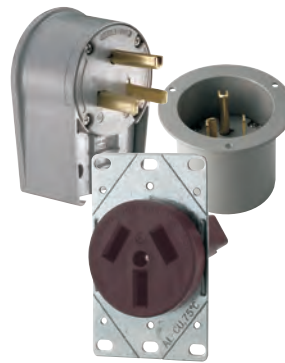
**Specification Grade Straight Blade Power Devices**

Heavy duty design and construction make Arrow Hart power devices ideal for any high amperage industrial or commercial power connectivity application.

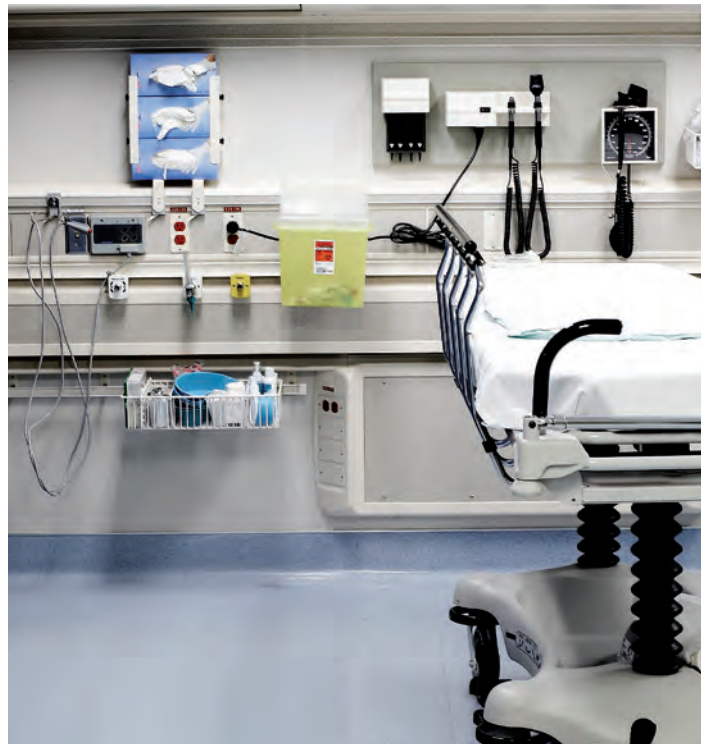
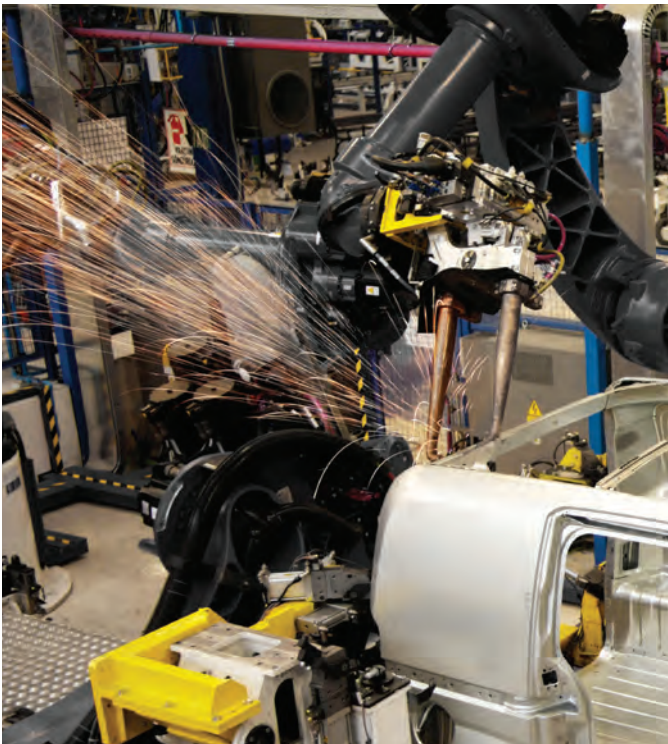

SafetyGrip Hospital and Industrial Grade Plugs & Connectors

1 Rugged nylon body resists impact and exposure to chemicals

2 Neoprene gasket seals around cord for added terminal protection from external elements

3 Dual range cord grip provides positive cord gripping while limiting strain on conductors

4 Rating information clearly marked on face of device

5 Wiring chamber provides generous space for wiring

6 Textured surface allows for easy grip and handling

Back Body

Front Body



SafetyGrip Hospital Grade devices exceed Federal Spec. and Hospital Grade testing for use in demanding healthcare environments



Clear terminal cover allows for easy inspection of conductors and terminations



Retained quick drive assembly screws speed installation



Four position angled plug option is ideal for applications requiring power cord to lay close to walls and floors

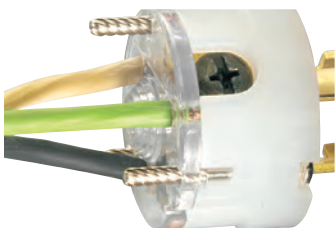

Tapered, individual wire pockets guide stranded wire into contact area for ease of installation

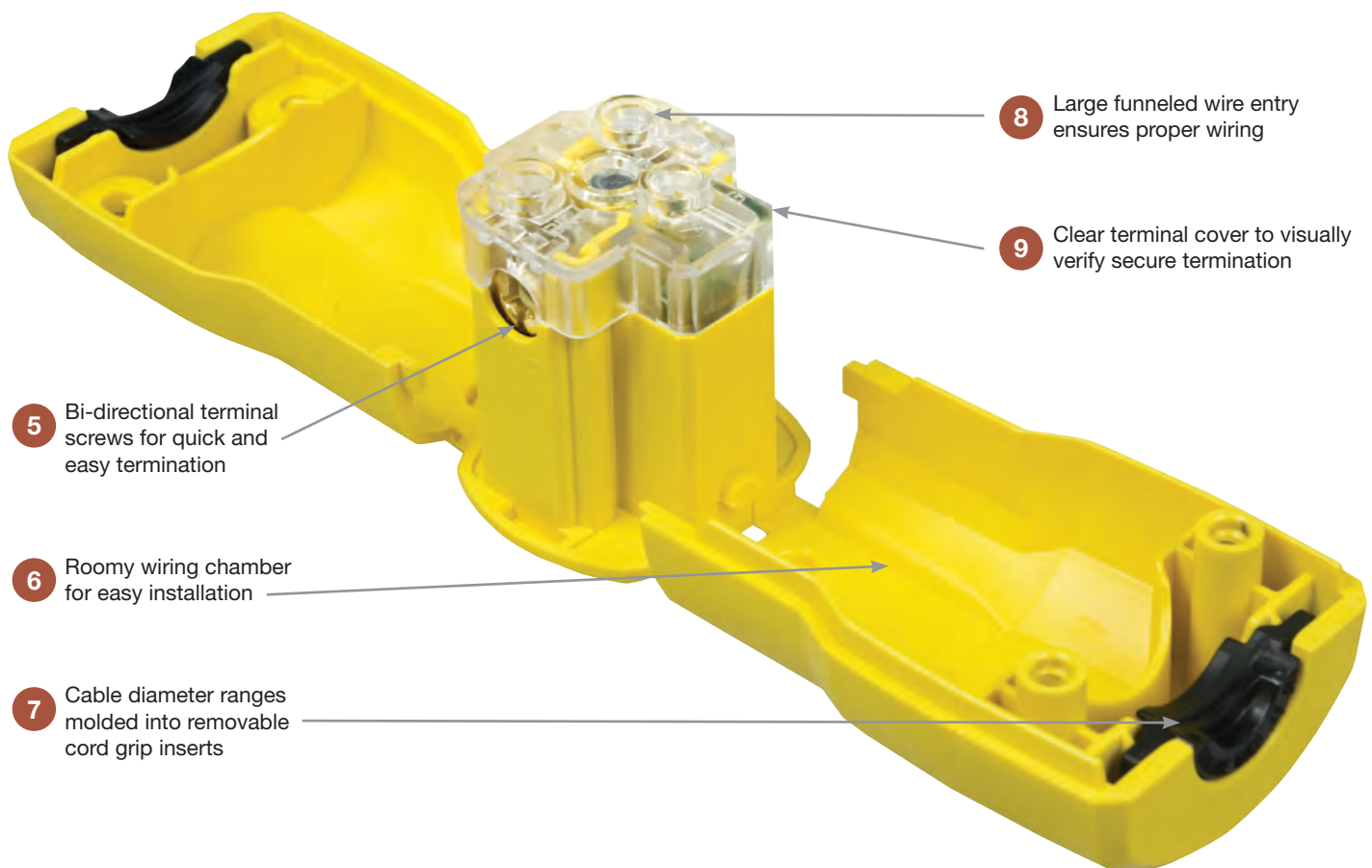
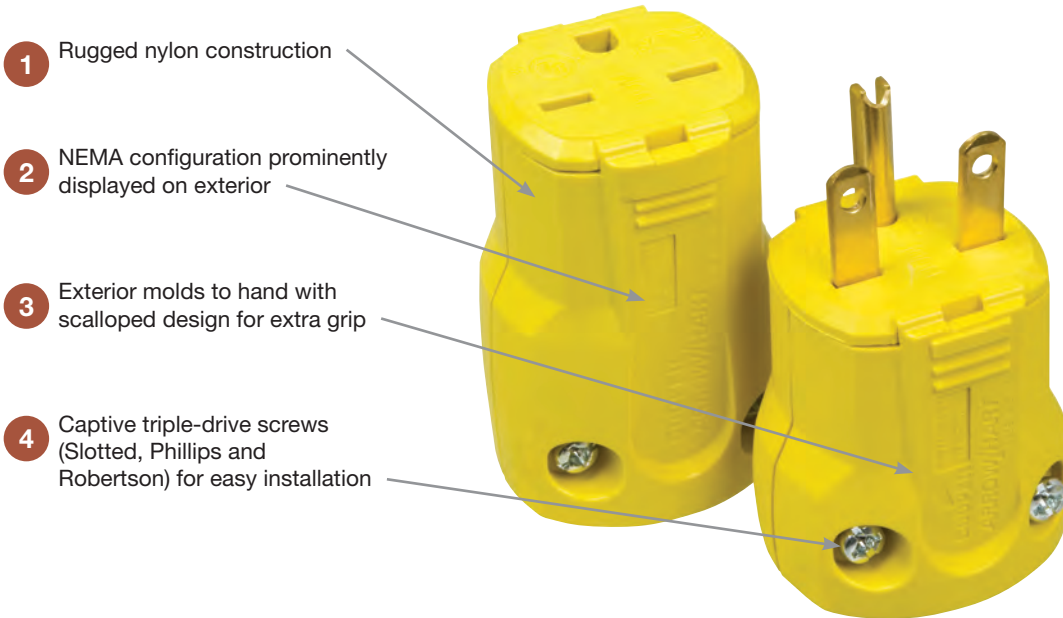

Multiple-head drive screws provide versatility for ease of use

QuickGrip Hospital and Industrial Grade Plugs & Connectors

Specifications and availability are subject to change without notice.

AutoGrip Hospital and Industrial Grade Plugs & Connectors

1 Smooth, tapered body reduces snagging and provides easy handling

2 Neoprene gasket seals around cord for added terminal protection from external elements

3 Rugged nylon body resists impact and exposure to chemicals

4 Single piece grounding contacts for superior continuity

5 AutoGrip clamp design secures cord during assembly, reducing installation time

Back Body

Front Body



AutoGrip Hospital Grade devices exceed Federal Spec. and Hospital Grade testing for use in demanding healthcare environments



Unique clamp design secures cord during assembly, reducing installation time



Retained quick drive assembly screws speed installation



Multiple-head drive screws provide versatility for ease of use



Tapered, individual wire pockets guide stranded wire into contact area for ease of installation

Specifications and availability are subject to change without notice.

**Industrial Grade
Straight Blade Devices**

2-Pole, 3-Wire Grounding
15A, 125V/AC
NEMA 5-15



5-15P



5-15R

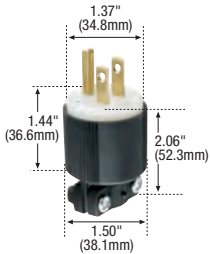

6266



AH5969BK



5278C



5278

Industrial Grade Plugs & Connectors



Rating A	V/AC	NEMA	Description	Cord Diameter	Color	Plug Catalog No.	Connector Catalog No.	
15	125	5-15	SafetyGrip Straight Body	0.33-0.66" (8.3-16.7mm)	BK & W	□ 6266	□ 6269	•
			SafetyGrip Straight Body	0.33-0.66" (8.3-16.7mm)	BK	□ 6266BLK	□ 6269BLK	•
			SafetyGrip Angled Body	0.33-0.66" (8.3-16.7mm)	BK & W	□ 6265	—	•
			QuickGrip Straight Body	0.22-0.66" (5.6-16.7mm)	BK	□ AH5965BK	□ AH5969BK	
			QuickGrip Straight Body	0.22-0.66" (5.6-16.7mm)	Y	□ AH5965Y	□ AH5969Y	
			AutoGrip Straight Body	0.33-0.66" (8.3-16.7mm)	BK & W	□ 5266N	□ 5269N	•

Industrial Grade Flanged Inlets & Outlets



Rating A	V/AC	NEMA	Description	Color	Plug Catalog No.	Connector Catalog No.	
15	125	5-15	Nylon Construction, Back Wire	BK & W	□ 5278C†	□ 5279C*	•
			Metal Shell, Back Wire	Steel	□ 5278	—	•
			Metal Shell, Back Wire	Steel	—	□ 5246*	

* UL Listed Only, † Fed Spec Certified

Industrial Grade Dimensional
Information: B-14-B-15

Specification Information:
SafetyGrip Industrial Plugs &
Connectors: B-22
QuickGrip Plugs &
Connectors: B-22
AutoGrip Industrial Plugs &
Connectors: B-22
Industrial Flanged Inlets &
Flanged Outlets: B-23

Color Information:

BK (Black), C (Clear), RN (Orange), W (White), Y (Yellow)



Specifications and availability are subject to change without notice.

Indicates NAFTA Compliant - Page R-30

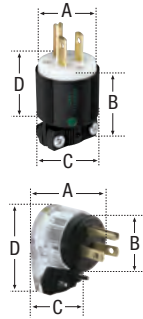
SafetyGrip Plugs

Family	A	B	C	D	Cord Diameter
Hospital Grade	1.37" (34.8mm)	2.06" (52.3mm)	1.50" (38.1mm)	1.44" (36.6mm)	0.33-0.66" (8.3-16.7mm)
Hospital Grade Angled	1.46" (37.1mm)	1.50" (38.1mm)	1.28" (32.5mm)	2.06" (52.3mm)	0.33-0.66" (8.3-16.7mm)
Industrial Grade	1.37" (34.8mm)	2.06" (52.3mm)	1.50" (38.1mm)	1.44" (36.6mm)	0.33-0.66" (8.3-16.7mm)
Industrial Grade Angled	1.28" (32.5mm)	1.46" (37.1mm)	1.50" (38.1mm)	2.06" (52.3mm)	0.33-0.66" (8.3-16.7mm)
Industrial Grade NEMA 7-20, 10-20 & 18-20	1.78" (45.2mm)	2.34" (59.4mm)	2.13" (54.1mm)	–	0.38"-1.00" (9.6-25.4mm)

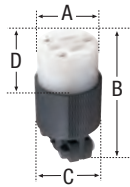
SafetyGrip Connectors

Family	A	B	C	D	Cord Diameter
Hospital Grade	1.37" (34.8mm)	2.77" (70.4mm)	1.50" (38.1mm)	0.87" (22.1mm)	0.33-0.66" (8.3-16.7mm)
Industrial Grade	1.37" (34.8mm)	2.77" (70.4mm)	1.50" (38.1mm)	0.87" (22.1mm)	0.33-0.66" (8.3-16.7mm)

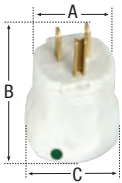
QuickGrip Plugs

Family	A	B	C	Cord Diameter
Hospital Grade	1.47" (37.3mm)	2.77" (70.4mm)	1.67" (42.4mm)	0.22-0.66" (5.6-16.7mm)
Industrial Grade	1.47" (37.3mm)	2.77" (70.4mm)	1.67" (42.4mm)	0.22-0.66" (5.6-16.7mm)

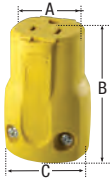
QuickGrip Connectors

Family	A	B	C	Cord Diameter
Industrial Grade	1.46" (37.1mm)	2.59" (65.8mm)	1.67" (42.4mm)	0.22-0.66" (5.6-16.7mm)

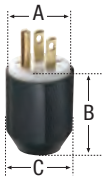
AutoGrip Plugs

Family	A	B	C	Cord Diameter
Hospital Grade	1.38" (34.9mm)	1.83" (46.5mm)	1.52" (38.6mm)	0.33-0.66" (8.3-16.7mm)
Industrial Grade	1.37" (34.8mm)	1.83" (46.5mm)	1.51" (38.4mm)	0.33-0.66" (8.3-16.7mm)

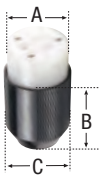
AutoGrip Connectors

Family	A	B	C	Cord Diameter
Hospital Grade	1.38" (34.9mm)	1.83" (46.5mm)	1.52" (38.6mm)	0.33-0.66" (8.3-16.7mm)
Industrial Grade	1.37" (34.8mm)	1.83" (46.5mm)	1.51" (38.4mm)	0.33-0.66" (8.3-16.7mm)

Specifications and availability are subject to change without notice.

Nylon Shell Flanged Inlets

Family	A	B	C
Industrial Grade	2.56" (65.0mm)	1.84" (46.7mm)	1.71" (43.4mm)



Nylon Shell Flanged Outlets

Family	A	B	C
Industrial Grade	2.56" (65.0mm)	1.84" (46.7mm)	1.71" (43.4mm)



Metal Shell Flanged Inlets

Family	A	B	C
Industrial Grade	2.00" (50.8mm)	1.43" (36.3mm)	1.62" (41.1mm)



Metal Shell Flanged Outlets

Family	A	B	C
Industrial Grade	2.06" (52.3mm)	1.50" (38.1mm)	1.09" (27.7mm)



Commercial Plugs

Family	A	B	C	D	Cord Diameter
Commercial Grade	1.65" (41.9mm)	1.54" (39.1mm)	-	-	0.25-0.66" (6.4-16.6mm)
Commercial Grade Angled	1.25" (31.8mm)	1.42" (36.1mm)	1.50" (38.1mm)	1.95" (49.5mm)	0.25-0.66" (6.4-16.6mm)

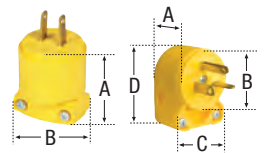

Commercial Connectors

Family	A	B	C	Cord Diameter
Commercial Grade	1.35" (34.3mm)	2.61" (66.3mm)	1.54" (39.1mm)	0.25-0.66" (6.4-16.6mm)

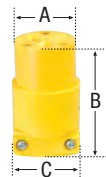

Specifications and availability are subject to change without notice.

Industrial Grade Plugs & Connectors

2-Pole, 3-Wire Grounding
3-Pole, 3-Wire Non-Grounding
4-Pole, 4-Wire Non-Grounding

Device Type	Industrial Grade SafetyGrip Plugs & Connectors, Straight Blade	Industrial Grade AutoGrip Plugs & Connectors, Straight Blade	Industrial Grade QuickGrip Plugs & Connectors, Straight Blade	
Wiring Type	Back Wire	Back Wire	Back Wire	
Testing & Code Compliance	<ul style="list-style-type: none"> cULus Listed to UL498, file no. E3663 Complies with Federal Spec. WC-596F CSA certified to C22.2, no. 42-99 file no. 7087 (6221-02) 7251N: NOM certified 	<ul style="list-style-type: none"> Listed to UL498, file no. E3663 UL verified to Fed Spec WC-596F except cat. no. 5266AN CSA certified to C22.2, no. 42-99 file no. 2081 (6221-02) 	<ul style="list-style-type: none"> cULus Listed to UL498, file no. E15012 UL verified to Federal Spec. WC-596G 	
	Flammability	Meets UL94 requirements, V2 rated	Meets UL94 requirements, V2 rated	Meets UL94 requirements, V2 rated
	Temperature Rating	-40°C to 75°C (-40°F to 167°F)	-40°C to 75°C (-40°F to 167°F)	-40°C to 75°C (-40°F to 167°F)
	Dielectric Voltage	Twice the device rating + 1000V per UL498	Twice the device rating + 1000V per UL498	Twice the device rating + 1000V per UL498
Specifications: Electrical	Current Interrupting	Yes, at full-rated current	Yes, at full-rated current	Yes, at full-rated current
	Temperature Rise	Max. 30°C (86°F) after 200 cycles of overload @ 200% of rated current (DC)	Max. 30°C (86°F) after 50 cycles of overload @ 150% of rated current (DC)	Max. 30°C (86°F) after 100 cycles of overload @ 150% of rated current (DC)
Specifications: Mechanical	Terminal Accommodation	#16 - #12 AWG, except 7624N, 9151N, 7251N: #18 - #10 AWG	#18 - #12 AWG	#18 - #12 AWG
	Voltage Ratings	Permanently marked on device	Permanently marked on device	Permanently marked on device
Materials:	Plug/Connector Outer Shell	Nylon	Nylon	Nylon
	Interior Body	Nylon	Nylon	N/A
	Terminal Retainer	Polycarbonate	Polycarbonate	Polycarbonate
	Blades	0.065" thick brass	0.065" thick brass	0.060" thick brass
	Line Contacts	0.031" thick brass	0.031" thick brass	0.030" thick brass
	Terminal Clamps	Steel, zinc plated	Steel, zinc plated	Steel, zinc plated
	Terminal Screws	#8-32 brass, nickel plated	#8-32 brass, nickel plated	Steel, brass plated (hot) and zinc plated (neutral)
	Ground Contact	0.041" thick brass	0.041" thick bronze	Brass
	Ground Screw	#8-32 brass, zinc plated, green	#8-32 brass, green	Steel, zinc plated, green
	Assembly/ Mounting Screws	Steel, zinc plated	Steel, zinc plated	Steel, zinc plated
	Cord Clamp	Nylon	Polypropylene	Nylon
	Cord Clamp Screws	Steel, zinc plated	N/A	N/A
	Gasket/Dust Shield	Neoprene	Neoprene	N/A

Specifications and availability are subject to change without notice.

Industrial Grade Flanged Inlets & Flanged Outlets

2-Pole, 3-Wire Grounding
 15A, 125V/AC; 15A, 250V/AC; 20A, 125V/AC; 20A, 250V/AC
 NEMA 5-15, 6-15, 5-20, 6-20

Device Type	Industrial Grade Flanged Inlets, Straight Blade	Industrial Grade Flanged Outlets, Straight Blade
Wiring Type	Side Wire	Side Wire
Testing & Code Compliance	• Listed to UL498, file no. E3663	• Listed to UL498, file no. E2369
	• cUL Listed to CSA C22.2, no. 42-M1999	• CSA certified to C22.2, no. 42-99 & 182.3-M1987 file no. 7087 (6233-01)
	• 5278C, 5678C: also NOM certified	
Specifications: Environmental	Flammability	Meets UL94 requirements, V2 rated
	Temperature Rating	-40°C to 105°C (-40°F to 221°F)
Specifications: Electrical	Dielectric Voltage	Twice the device rating + 1000V per UL498
	Current Interrupting	Yes, at full-rated current
	Temperature Rise	Max. 30°C (86°F) after 100 cycles of overload @ 150% of rated current (DC)
Specifications: Mechanical	Terminal Accommodation	#14 AWG
	Voltage Ratings	Permanently marked on device
Materials:	Outer Shell	Nylon, except 5278C: steel
	Interior Body	Lexan, except 5278C: urea
	Terminal Retainer	Lexan, except 5278C: urea
	Blades	0.062" thick brass, except 5278C: 0.040"
	Line Contacts	0.062" thick brass
	Terminal Clamps	Brass
	Terminal Screws	#8-32 steel, brass plated (hot) or nickel plated (neutral), except 5278C: #6-32
	Ground Screw	#8-32 brass, zinc plated, green, except 5278C: #6-40
Assembly Screws/Rivets	Steel screws, except 5278C: steel rivets, zinc plated	

Specifications and availability are subject to change without notice.