



Wiremold

880 Series™ Floor Boxes

Single-Service Round Floor Boxes

Wiremold® 880 Series Floor Box provides an excellent solution for the low density power or communication requirements in open space areas. The 880 Series brings the power or communication service directly to the workstation. The 880 Series comes in a cast iron version for on grade applications and an economical stamped steel version for above grade applications. The 880 Series is supported by one of the most complete lines of brass, brushed aluminum, and nonmetallic activations in the industry. Some applications for the 880 Series Floor Box are retail facilities, commercial offices, hotels, and financial institutions.



Protection from water, dirt, and debris.

880 Series Steel Floor Box.

FEATURES & BENEFITS

- **Snap down ring assembly for steel floor boxes.** Labor saver.
- **Fully adjustable box.** Can adjust before and after concrete pour. Lower installed cost.
- **Handles single and duplex devices.** Economical solution for low density power requirements.
- **All 895 and 896 Cover Plates fit 885B, 886B, 887B, and 889B Floor Boxes.** More activation options to meet any decor.
- **BAA Aluminum Covers.** Round aluminum covers are now available in a version that complies with the Buy America Act and the ARRA requirements. Covers are available in five powder coated finishes (black, gray, brass bronze and nickel). 
- **Two different depths.** Accommodates various pour depths and wiring capacity requirements.
- **TopGuard protection.** An integral design which keeps out water, dirt, and debris from the power and communication compartments. Whenever you see the TopGuard protection icon applied to any Wiremold product, you will know that the product meets and exceeds the new UL scrub water exclusion requirement.
- **UL Listed to U.S. and Canadian safety standards for tile, terrazzo, and the UL requirements under UL514A and UL514C for the scrub water exclusion test for carpet and wood floors.**



880 Series Cast Iron Floor Box with 896TCK Brass Communications or Power Cover.

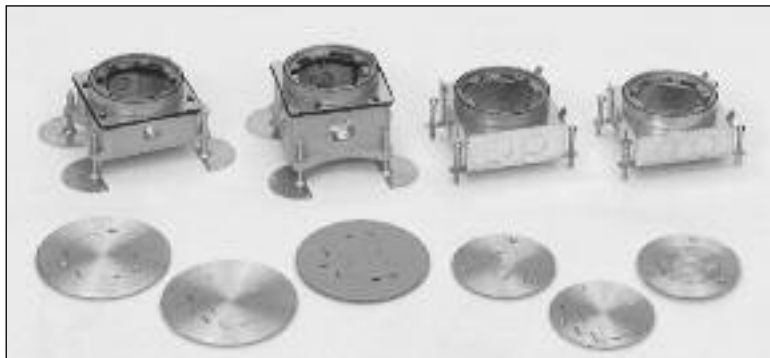

The 880 Series family of steel and cast-iron Floor Boxes.

880 Series Steel Floor Box Ordering Information

Catalog No./Item

Description/Specifications

885B

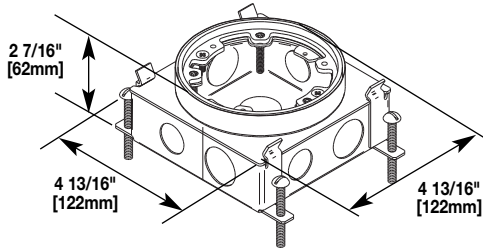

Floor Box – Stamped steel, shallow single-service.

Country of Origin: Mexico

TECHNICAL SPECIFICATIONS

Class	Catalog No.	Adjustment		Capacity Cu In	Knockouts or Conduit Openings
		Before the Pour	After the Pour		
Concrete-Tight (Steel)	885B	1 3/4" [44mm]	1/2" [12.7mm]	29.5 [484ml]	Four Sides – (1) 1/2" [12.7mm] (1) 3/4" [19.1mm] Bottom – (2) 1/2" [12.7mm] (2) 3/4" [19.1mm]

886B

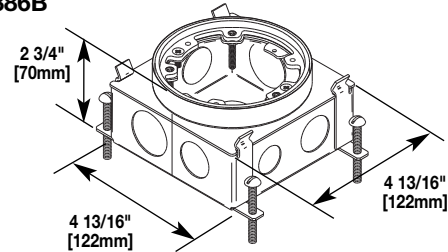

Floor Box – Stamped steel, deep single-service.

Country of Origin: Mexico

TECHNICAL SPECIFICATIONS

Class	Catalog No.	Adjustment		Capacity Cu In	Knockouts or Conduit Openings
		Before the Pour	After the Pour		
Concrete-Tight (Steel)	886B	1 3/4" [44mm]	1/2" [12.7mm]	39 [639ml]	Two Sides – (1) 1/2" [12.7mm] (1) 3/4" [19.1mm] Two Sides – (1) 3/4" [19.1mm] (1) 1" [25mm] Bottom – (2) 1/2" [12.7mm] (2) 3/4" [19.1mm]

880 Series Cast-Iron Floor Box Ordering Information

Catalog No./Item

Description/Specifications

887B

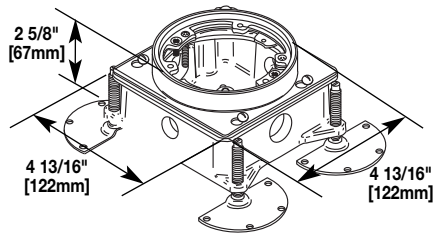

Floor Box – Cast-iron, shallow single-service.

Country of Origin: USA

Technical Specifications

Class	Catalog No.	Adjustment		Capacity Cu In	Knockouts or Conduit Openings
		Before the Pour	After the Pour		
Watertight (Cast-Iron)	887B	2" [51mm]	1/2" [12.7mm]	24.7 [405ml]	Two Sides – (1) 1/2" [12.7mm] Two Sides – (1) 3/4" [19.1mm]

889B

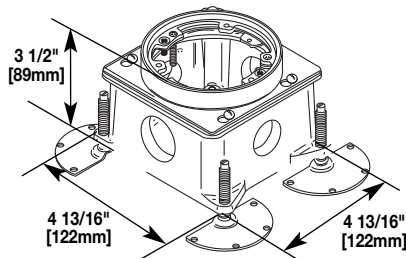

Floor Box – Cast-iron, deep single-service.

Country of Origin: USA

Technical Specifications

Class	Catalog No.	Adjustment		Capacity Cu In	Knockouts or Conduit Openings
		Before the Pour	After the Pour		
Watertight (Cast-Iron)	889B	2" [51mm]	1/2" [12.7mm]	40 [665ml]	Two Sides – (1) 1" [25mm] Two Sides – (1) 1 1/4" [19.1mm]

Cover Plates for 880 Series Floor Boxes Ordering Information

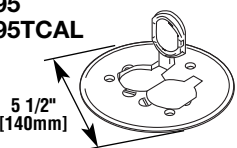
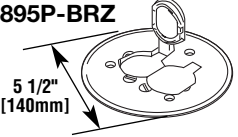
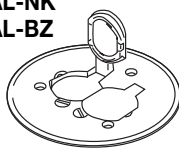
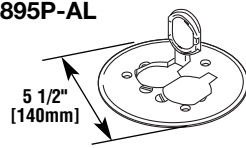
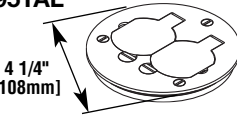
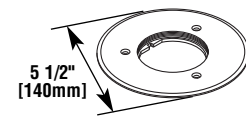
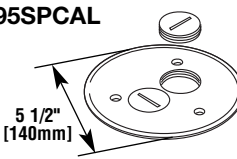
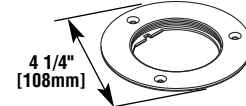
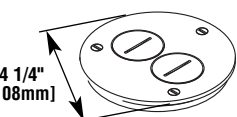
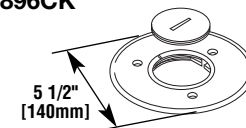
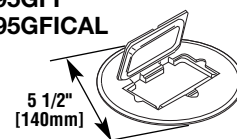
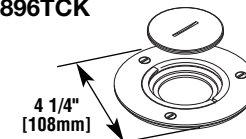
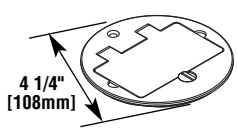
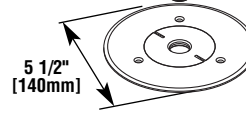
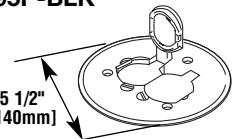
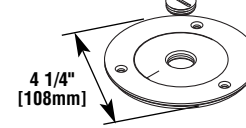
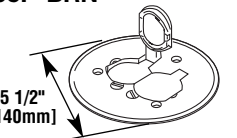
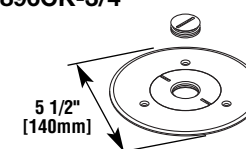
Catalog No./Item	Description/Specifications	Catalog No./Item	Description/Specifications
895 895TCAL 	Duplex Cover Plate with Flip Lid – Brass (895) or brushed aluminum (895TCAL) duplex cover plate with flip lids, 5 1/2" [140mm] for carpet. Country of Origin: China	895P-BRZ 	Duplex Cover Plate – Bronze polycarbonate duplex cover plate with flip lids for carpet. Country of Origin: USA
895TCAL-BK 895TCAL-BS 895TCAL-GY 895TCAL-NK 895TCAL-BZ 	Aluminum Duplex Power Plate – With flip lids, 5 1/2" [140mm] diameter for carpet. Available in black (895TCAL-BK), brass (895TCAL-BS), gray (895TCAL-GY), nickel (895TCAL-NK) and bronze (895TCAL-BZ) Country of Origin: USA	895P-AL 	Duplex Cover Plate – Aluminum polycarbonate duplex cover plate with flip lids for carpet. Country of Origin: USA
895T 895TAL 	Duplex Cover Plate with Flip Lid – Brass (895T) or brushed aluminum (895TAL) duplex cover plate with flip lids, 4 1/4" [108mm] for tile. Country of Origin: China	896 	Communications or Power Cover Plate – Brass communications or power cover plate with 2 5/8" [67mm] threaded opening for carpet. Sold without abandon plug. Country of Origin: China
895SP 895SPCAL 	Cover Plate with Two Screw Plate Openings – Brass (895SP) or brushed aluminum (895SPCAL) cover plate with two 1 1/2" [38mm] screw plug openings, 5 1/2" [140mm] for carpet. Country of Origin: China	896T 	Communications or Power Cover Plate – Brass communications or power cover plate with 2 5/8" [67mm] threaded opening for carpet. Sold without abandon plug. Country of Origin: China
895TSP 	Cover Plate with Two Screw Plate Openings – Brass cover plate with two 1 1/2" [38mm] screw plug openings, 4 1/4" [108mm] for tile. Country of Origin: China	896CK 	Communications or Power Cover Plate – Brass communications or power cover plate with 2 1/4" [57mm] threaded opening for carpet. Country of Origin: China
895GFI 895GFICAL 	GFI Receptacle Cover Plate – Brass (895GFI) or brushed aluminum (895GFICAL) GFI receptacle cover plate, 5 1/2" [140mm] for carpet. Country of Origin: China	896TCK 	Communications or Power Cover Plate – Brass communications or power cover plate with 2 1/4" [57mm] threaded opening for carpet. Country of Origin: China
895TGFI 895TGFIAL 	GFI Receptacle Cover Plate – Brass (895TGFI) or brushed aluminum (895TGFIAL) GFI receptacle cover plate, 4 1/4" [108mm] for tile. Country of Origin: China	896CK-1/2 896CKAL-1/2 	Communications or Power Cover Plate – Brass (896CK-1/2) or brushed aluminum (896CKAL-1/2) cover plate with 1/2" [12.7mm] threaded opening 5 1/2" [140mm] for carpet. Country of Origin: China
895P-BLK 	Duplex Cover Plate – Black polycarbonate duplex cover plate with flip lids for carpet. Country of Origin: USA	896TCK-1/2 896TCKAL-1/2 	Communications or Power Cover Plate – Brass (896TCK-1/2) or brushed aluminum (896TCKAL-1/2) cover plate with 1/2" [12.7mm] threaded opening, 4 1/4" [108mm] for tile. Country of Origin: China
895P-BRN 	Duplex Cover Plate – Brown polycarbonate duplex cover plate with flip lids for carpet. Country of Origin: USA	896CK-3/4 	Communications or Power Cover Plate – Brass cover plate with 3/4" [19.1mm] threaded opening for carpet. Country of Origin: China

NOTE: All cover plates are furnished with gasket and three screws.

Cover Plates for 880 Series Floor Boxes Ordering Information (continued)

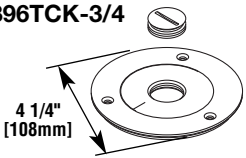
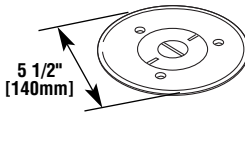
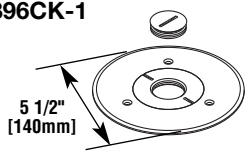
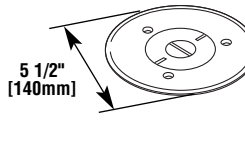
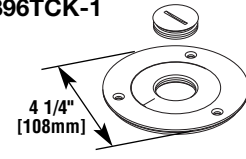
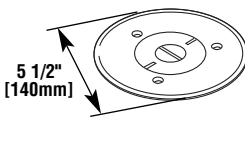
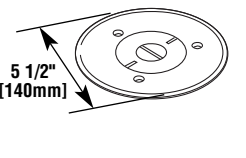
Catalog No./Item	Description/Specifications	Catalog No./Item	Description/Specifications
896TCK-3/4 	Communications or Power Cover Plate – Brass cover plate with 3/4" [19.1mm] threaded opening for tile. Country of Origin: China	896PCK-BRN 	Communications or Power Cover Plate – Brown polycarbonate communications or power cover plate. Includes one plug with 3/4" [19mm] opening, one plug with 1" [25mm] opening, and one plug with 2 5/8" [67mm] opening. For pass-through only. Country of Origin: USA
896CK-1 	Communications or Power Cover Plate – Brass cover plate with 1" [25mm] threaded opening for carpet. Country of Origin: China	896PCK-BRZ 	Communications or Power Cover Plate – Bronze polycarbonate communications or power cover plate. Includes one plug with 3/4" [19mm] opening, one plug with 1" [25mm] opening, and one plug with 2 5/8" [67mm] opening. For pass-through only. Country of Origin: USA
896TCK-1 	Communications or Power Cover Plate – Brass cover plate with 1" [25mm] threaded opening for tile. Country of Origin: China	896PCK-AL 	Communications or Power Cover Plate – Aluminum polycarbonate communications or power cover plate. Includes one plug with 3/4" [19mm] opening, one plug with 1" [25mm] opening, and one plug with 2 5/8" [67mm] opening. For pass-through only. Country of Origin: USA
896PCK-BLK 	Communications or Power Cover Plate – Black polycarbonate communications or power cover plate. Includes one plug with 3/4" [19mm] opening, one plug with 1" [25mm] opening, and one plug with 2 5/8" [67mm] opening. For pass-through only. Country of Origin: USA		

885 Series Floor Box Installations

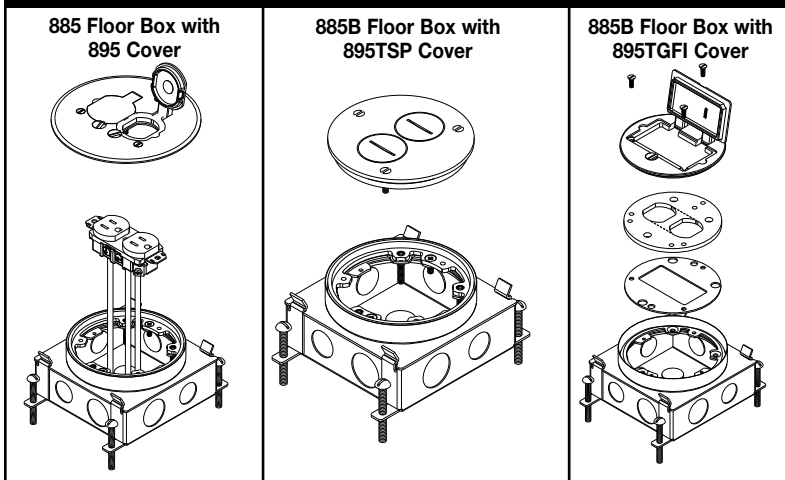

Retrofit Installations

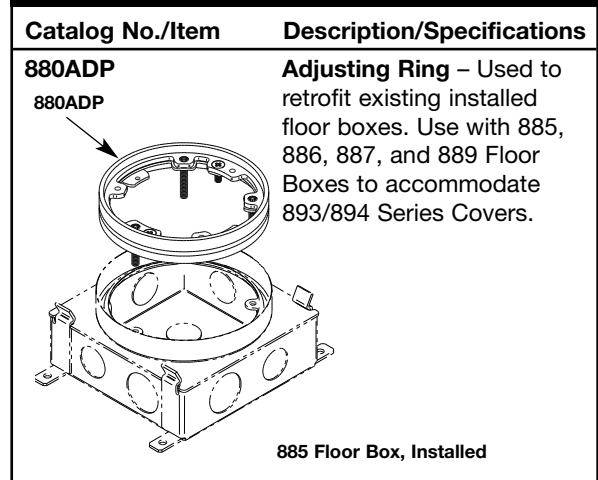

60 Woodlawn Street
 West Hartford, CT 06110
 Phone: 1.877.BY.LEGRAND (295-3472)
 Fax: 1.860.232.2062
 www.legrand.us/wiremold
 570 Applewood Crescent
 Vaughan, Ontario L4K 4B4
 Phone: 905.738.9195
 Fax: 905.738.9721





Wiremold

880 Series™ Floor Boxes

Single-Service Round Floor Boxes

Wiremold® 880 Series Floor Box provides an excellent solution for the low density power or communication requirements in open space areas. The 880 Series brings the power or communication service directly to the workstation. The 880 Series comes in a cast iron version for on grade applications and an economical stamped steel version for above grade applications. The 880 Series is supported by one of the most complete lines of brass, brushed aluminum, and nonmetallic activations in the industry. Some applications for the 880 Series Floor Box are retail facilities, commercial offices, hotels, and financial institutions.



Protection from water, dirt, and debris.

880 Series Steel Floor Box.

FEATURES & BENEFITS

- **Snap down ring assembly for steel floor boxes.** Labor saver.
- **Fully adjustable box.** Can adjust before and after concrete pour. Lower installed cost.
- **Handles single and duplex devices.** Economical solution for low density power requirements.
- **All 895 and 896 Cover Plates fit 885B, 886B, 887B, and 889B Floor Boxes.** More activation options to meet any decor.
- **BAA Aluminum Covers.** Round aluminum covers are now available in a version that complies with the Buy America Act and the ARRA requirements. Covers are available in five powder coated finishes (black, gray, brass bronze and nickel). 
- **Two different depths.** Accommodates various pour depths and wiring capacity requirements.
- **TopGuard protection.** An integral design which keeps out water, dirt, and debris from the power and communication compartments. Whenever you see the TopGuard protection icon applied to any Wiremold product, you will know that the product meets and exceeds the new UL scrub water exclusion requirement.
- **UL Listed to U.S. and Canadian safety standards for tile, terrazzo, and the UL requirements under UL514A and UL514C for the scrub water exclusion test for carpet and wood floors.**



880 Series Cast Iron Floor Box with 896TCK Brass Communications or Power Cover.



The 880 Series family of steel and cast-iron Floor Boxes.

880 Series Steel Floor Box Ordering Information

Catalog No./Item

Description/Specifications

885B

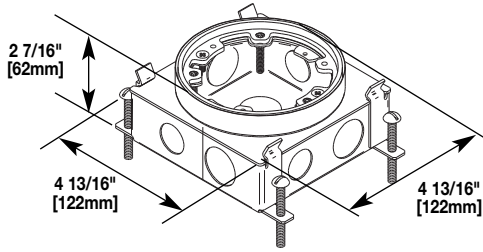

Floor Box – Stamped steel, shallow single-service.

Country of Origin: Mexico

TECHNICAL SPECIFICATIONS

Class	Catalog No.	Adjustment		Capacity Cu In	Knockouts or Conduit Openings
		Before the Pour	After the Pour		
Concrete-Tight (Steel)	885B	1 3/4" [44mm]	1/2" [12.7mm]	29.5 [484ml]	Four Sides – (1) 1/2" [12.7mm] (1) 3/4" [19.1mm] Bottom – (2) 1/2" [12.7mm] (2) 3/4" [19.1mm]

886B

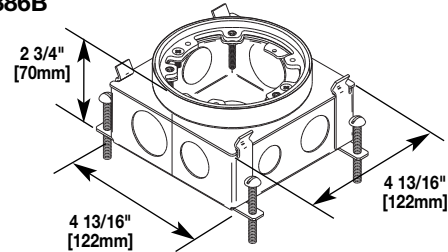

Floor Box – Stamped steel, deep single-service.

Country of Origin: Mexico

TECHNICAL SPECIFICATIONS

Class	Catalog No.	Adjustment		Capacity Cu In	Knockouts or Conduit Openings
		Before the Pour	After the Pour		
Concrete-Tight (Steel)	886B	1 3/4" [44mm]	1/2" [12.7mm]	39 [639ml]	Two Sides – (1) 1/2" [12.7mm] (1) 3/4" [19.1mm] Two Sides – (1) 3/4" [19.1mm] (1) 1" [25mm] Bottom – (2) 1/2" [12.7mm] (2) 3/4" [19.1mm]

880 Series Cast-Iron Floor Box Ordering Information

Catalog No./Item

Description/Specifications

887B

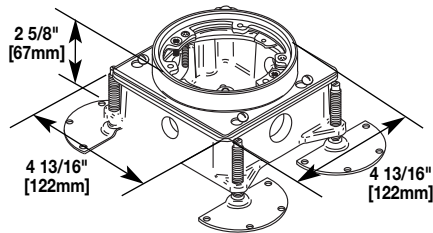

Floor Box – Cast-iron, shallow single-service.

Country of Origin: USA

Technical Specifications

Class	Catalog No.	Adjustment		Capacity Cu In	Knockouts or Conduit Openings
		Before the Pour	After the Pour		
Watertight (Cast-Iron)	887B	2" [51mm]	1/2" [12.7mm]	24.7 [405ml]	Two Sides – (1) 1/2" [12.7mm] Two Sides – (1) 3/4" [19.1mm]

889B

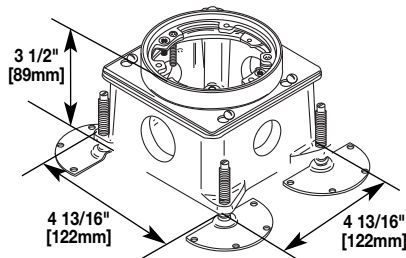

Floor Box – Cast-iron, deep single-service.

Country of Origin: USA

Technical Specifications

Class	Catalog No.	Adjustment		Capacity Cu In	Knockouts or Conduit Openings
		Before the Pour	After the Pour		
Watertight (Cast-Iron)	889B	2" [51mm]	1/2" [12.7mm]	40 [665ml]	Two Sides – (1) 1" [25mm] Two Sides – (1) 1 1/4" [19.1mm]

Cover Plates for 880 Series Floor Boxes Ordering Information

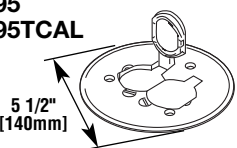
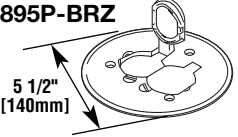
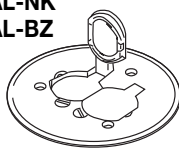
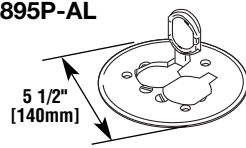
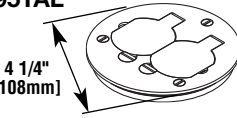
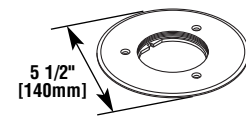
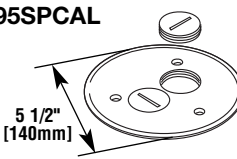
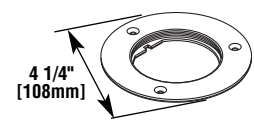
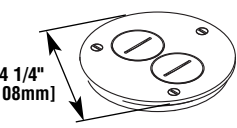
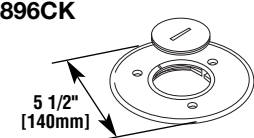
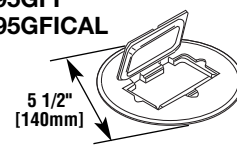
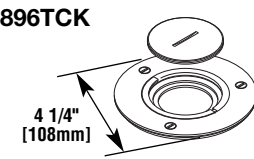
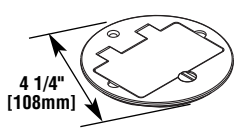
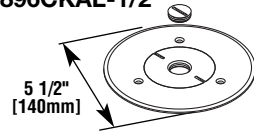
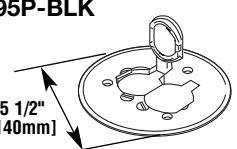
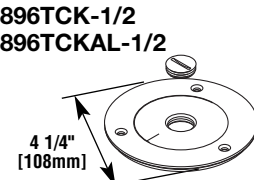
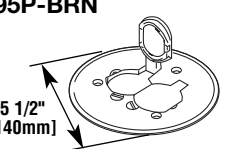
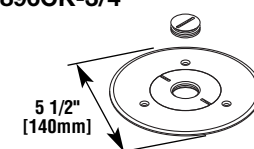
Catalog No./Item	Description/Specifications	Catalog No./Item	Description/Specifications
895 895TCAL 	Duplex Cover Plate with Flip Lid – Brass (895) or brushed aluminum (895TCAL) duplex cover plate with flip lids, 5 1/2" [140mm] for carpet. Country of Origin: China	895P-BRZ 	Duplex Cover Plate – Bronze polycarbonate duplex cover plate with flip lids for carpet. Country of Origin: USA
895TCAL-BK 895TCAL-BS 895TCAL-GY 895TCAL-NK 895TCAL-BZ 	Aluminum Duplex Power Plate – With flip lids, 5 1/2" [140mm] diameter for carpet. Available in black (895TCAL-BK), brass (895TCAL-BS), gray (895TCAL-GY), nickel (895TCAL-NK) and bronze (895TCAL-BZ) Country of Origin: USA	895P-AL 	Duplex Cover Plate – Aluminum polycarbonate duplex cover plate with flip lids for carpet. Country of Origin: USA
895T 895TAL 	Duplex Cover Plate with Flip Lid – Brass (895T) or brushed aluminum (895TAL) duplex cover plate with flip lids, 4 1/4" [108mm] for tile. Country of Origin: China	896 	Communications or Power Cover Plate – Brass communications or power cover plate with 2 5/8" [67mm] threaded opening for carpet. Sold without abandon plug. Country of Origin: China
895SP 895SPCAL 	Cover Plate with Two Screw Plate Openings – Brass (895SP) or brushed aluminum (895SPCAL) cover plate with two 1 1/2" [38mm] screw plug openings, 5 1/2" [140mm] for carpet. Country of Origin: China	896T 	Communications or Power Cover Plate – Brass communications or power cover plate with 2 5/8" [67mm] threaded opening for carpet. Sold without abandon plug. Country of Origin: China
895TSP 	Cover Plate with Two Screw Plate Openings – Brass cover plate with two 1 1/2" [38mm] screw plug openings, 4 1/4" [108mm] for tile. Country of Origin: China	896CK 	Communications or Power Cover Plate – Brass communications or power cover plate with 2 1/4" [57mm] threaded opening for carpet. Country of Origin: China
895GFI 895GFICAL 	GFI Receptacle Cover Plate – Brass (895GFI) or brushed aluminum (895GFICAL) GFI receptacle cover plate, 5 1/2" [140mm] for carpet. Country of Origin: China	896TCK 	Communications or Power Cover Plate – Brass communications or power cover plate with 2 1/4" [57mm] threaded opening for carpet. Country of Origin: China
895TGFI 895TGFIAL 	GFI Receptacle Cover Plate – Brass (895TGFI) or brushed aluminum (895TGFIAL) GFI receptacle cover plate, 4 1/4" [108mm] for tile. Country of Origin: China	896CK-1/2 896CKAL-1/2 	Communications or Power Cover Plate – Brass (896CK-1/2) or brushed aluminum (896CKAL-1/2) cover plate with 1/2" [12.7mm] threaded opening 5 1/2" [140mm] for carpet. Country of Origin: China
895P-BLK 	Duplex Cover Plate – Black polycarbonate duplex cover plate with flip lids for carpet. Country of Origin: USA	896TCK-1/2 896TCKAL-1/2 	Communications or Power Cover Plate – Brass (896TCK-1/2) or brushed aluminum (896TCKAL-1/2) cover plate with 1/2" [12.7mm] threaded opening, 4 1/4" [108mm] for tile. Country of Origin: China
895P-BRN 	Duplex Cover Plate – Brown polycarbonate duplex cover plate with flip lids for carpet. Country of Origin: USA	896CK-3/4 	Communications or Power Cover Plate – Brass cover plate with 3/4" [19.1mm] threaded opening for carpet. Country of Origin: China

NOTE: All cover plates are furnished with gasket and three screws.

Cover Plates for 880 Series Floor Boxes Ordering Information (continued)

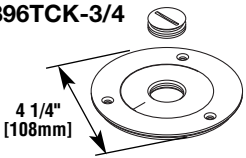
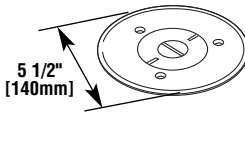
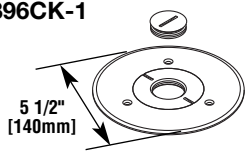
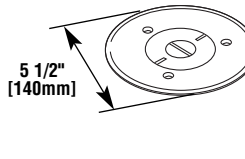
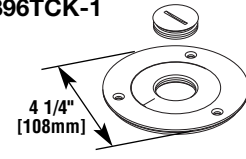
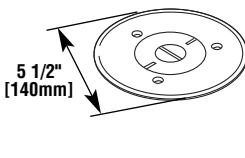
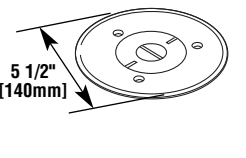
Catalog No./Item	Description/Specifications	Catalog No./Item	Description/Specifications
896TCK-3/4 	Communications or Power Cover Plate – Brass cover plate with 3/4" [19.1mm] threaded opening for tile. Country of Origin: China	896PCK-BRN 	Communications or Power Cover Plate – Brown polycarbonate communications or power cover plate. Includes one plug with 3/4" [19mm] opening, one plug with 1" [25mm] opening, and one plug with 2 5/8" [67mm] opening. For pass-through only. Country of Origin: USA
896CK-1 	Communications or Power Cover Plate – Brass cover plate with 1" [25mm] threaded opening for carpet. Country of Origin: China	896PCK-BRZ 	Communications or Power Cover Plate – Bronze polycarbonate communications or power cover plate. Includes one plug with 3/4" [19mm] opening, one plug with 1" [25mm] opening, and one plug with 2 5/8" [67mm] opening. For pass-through only. Country of Origin: USA
896TCK-1 	Communications or Power Cover Plate – Brass cover plate with 1" [25mm] threaded opening for tile. Country of Origin: China	896PCK-AL 	Communications or Power Cover Plate – Aluminum polycarbonate communications or power cover plate. Includes one plug with 3/4" [19mm] opening, one plug with 1" [25mm] opening, and one plug with 2 5/8" [67mm] opening. For pass-through only. Country of Origin: USA
896PCK-BLK 	Communications or Power Cover Plate – Black polycarbonate communications or power cover plate. Includes one plug with 3/4" [19mm] opening, one plug with 1" [25mm] opening, and one plug with 2 5/8" [67mm] opening. For pass-through only. Country of Origin: USA		

885 Series Floor Box Installations

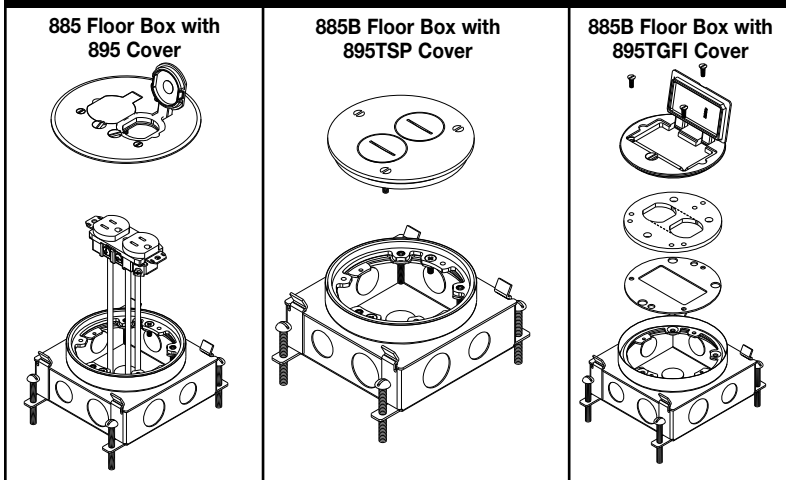

Retrofit Installations

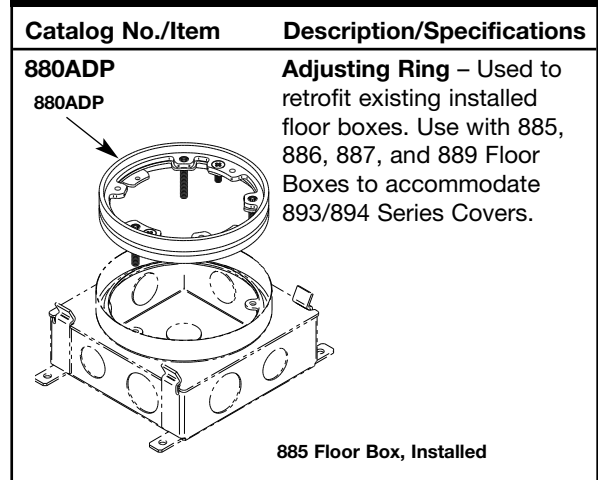

60 Woodlawn Street
 West Hartford, CT 06110
 Phone: 1.877.BY.LEGRAND (295-3472)
 Fax: 1.860.232.2062
www.legrand.us/wiremold
 570 Applewood Crescent
 Vaughan, Ontario L4K 4B4
 Phone: 905.738.9195
 Fax: 905.738.9721

