

Lay-In Wireway Type 1 Screw Cover	8-14
Lay-In Wireway Type 1 Quick-Connect Hinge Cover	15-20
Lay-In Wireway Type 3R EnviroShield™	21-24
Lay-In Wireway Type 12	25-31
Feed-Through Wireway Type 12	32-35
Feed-Through Wireway Type 4X	36-39
Wiring Trough Type 1 Screw Cover	40-41
Wiring Trough Type 3R Screw Cover	42-43
Wiring Trough Type 12 Lift-Off Cover	44-45
Wiring Trough Type 4X Lift-Off Cover	46-47

Lay-In Wireway Type 1 Screw Cover - Painted & Galvanized Data Sheet

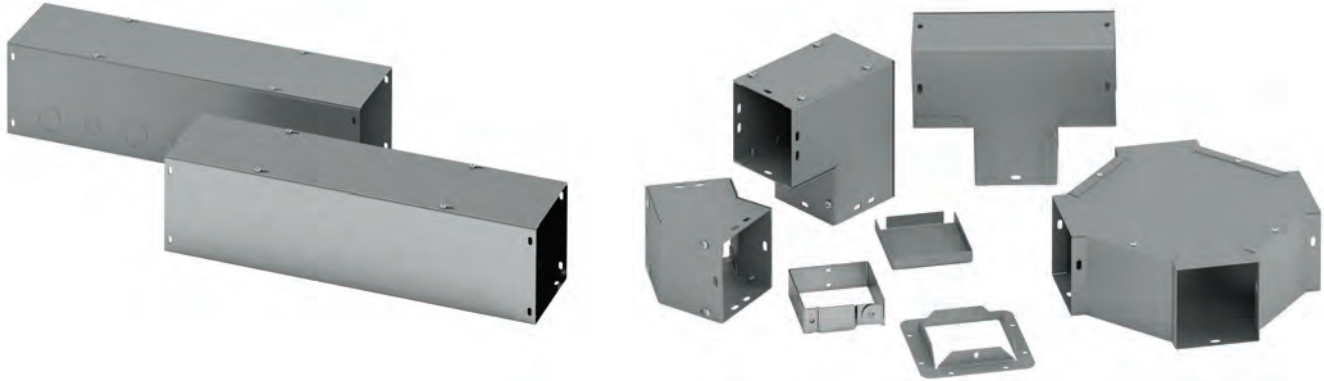

Application

- Houses runs of control and power cable
- Used for cable and wire junction, distribution and termination

Standards

- UL 870 listed, Type 1
- CSA C22.2 No. 26 certified, Type 1
- Conforms to NEMA standard for Type 1

Finish

- Wash and phosphate undercoat or galvanized steel
- ANSI 61 gray acrylic electrocoat finish

Accessories

- Sealing devices
- Touch-up paint
- See Accessories section

Construction

- Wireway body and cover are fabricated from code gauge steel or galvanized steel, (see table, pages 9 & 10)
- Wireway body has mounting holes on the back
- Wireway is available with or without knockouts
- Wireway fittings have no knockouts, ends are available with or without knockouts
- Cover is secured to the body with plated screws
- Keyhole slots are furnished on the wireway cover which allow easy access to the inside without removing the screws
- Wireway exceeding 72 inches in length has two overlapping covers
- Variety of fittings allow runs which can change direction, junction and terminate
- Standard wireway connectors (sold separately) have a gate feature which can swing completely open allowing for lay-in of wire and cable
- Interchangeable with Type 1 Hinge Cover Wireway and Fittings when HSCA connector is used, (see page 17)

Discount Schedule: A2

Subclass: AK1 (painted) & Z40 (galvanized)

Notes: We can provide special sizes, finishes and other modifications. Consult the factory for your special requirements.

Lay-In Wireway Type 1 Screw Cover - Painted & Galvanized Catalog Number

Subclass: Painted - AK1 & Galvanized - Z40

Wireway Catalog Number				Wireway Size				Gauge	Knockout Quantity	
Painted		Galvanized		Height x Depth x Length A x B x C		D			Top	Bottom
KO	No KO	KO	No KO	in.	mm	in.	mm			
2212 G	2212 G NK	--	2212 GGV NK	2.50 x 2.50 x 12.00	64 x 64 x 305	1.25	32	16	3	3
2224 G	2224 G NK	2224 GGV	2224 GGV NK	2.50 x 2.50 x 24.00	64 x 64 x 610	1.25	32	16	7	7
2236 G	2236 G NK	2236 GGV	2236 GGV NK	2.50 x 2.50 x 36.00	64 x 64 x 914	1.25	32	16	11	11
2248 G	2248 G NK	--	2248 GGV NK	2.50 x 2.50 x 48.00	64 x 64 x 1219	1.25	32	16	15	15
2260 G	2260 G NK	2260 GGV	2260 GGV NK	2.50 x 2.50 x 60.00	64 x 64 x 1524	1.25	32	16	23	23
22120 G	22120 G NK	22120 GGV	22120 GGV NK	2.50 x 2.50 x 120.00	64 x 64 x 3048	1.25	32	16	39	39
--	3312 G NK	--	--	3.00 x 3.00 x 12.00	76 x 76 x 305	1.50	38	16	3	3
--	3324 G NK	--	--	3.00 x 3.00 x 24.00	76 x 76 x 610	1.50	38	16	7	7
--	3336 G NK	--	--	3.00 x 3.00 x 36.00	76 x 76 x 914	1.50	38	16	11	11
--	3348 G NK	--	--	3.00 x 3.00 x 48.00	76 x 76 x 1219	1.50	38	16	15	15
--	3360 G NK	--	--	3.00 x 3.00 x 60.00	76 x 76 x 1524	1.50	38	16	19	19
--	3372 G NK	--	--	3.00 x 3.00 x 72.00	76 x 76 x 1829	1.50	38	16	23	23
--	33120 G NK	--	--	3.00 x 3.00 x 120.00	76 x 76 x 3048	1.50	38	16	39	39
4412 G	4412 G NK	4412 GGV	4412 GGV NK	4.00 x 4.00 x 12.00	102 x 102 x 305	2.75	70	16	3	3
4418 G	4418 G NK	--	4418 GGV NK	4.00 x 4.00 x 18.00	102 x 102 x 457	2.75	70	16	5	5
4424 G	4424 G NK	4424 GGV	4424 GGV NK	4.00 x 4.00 x 24.00	102 x 102 x 610	2.75	70	16	7	7
4436 G	4436 G NK	4436 GGV	4436 GGV NK	4.00 x 4.00 x 36.00	102 x 102 x 914	2.75	70	16	11	11
4448 G	4448 G NK	4448 GGV	4448 GGV NK	4.00 x 4.00 x 48.00	102 x 102 x 1219	2.75	70	16	15	15
4460 G	4460 G NK	4460 GGV	4460 GGV NK	4.00 x 4.00 x 60.00	102 x 102 x 1524	2.75	70	16	19	19
4472 G	4472 G NK	4472 GGV	4472 GGV NK	4.00 x 4.00 x 72.00	102 x 102 x 1829	2.75	70	16	23	23
44120 G	44120 G NK	44120 GGV	44120 GGV NK	4.00 x 4.00 x 120.00	102 x 102 x 3048	2.75	70	16	39	39
--	6412 G NK	--	--	6.00 x 4.00 x 12.00	152 x 102 x 305	4.25	108	16	3	3
--	6418 G NK	--	--	6.00 x 4.00 x 18.00	152 x 102 x 457	4.25	108	16	5	5
--	6424 G NK	--	--	6.00 x 4.00 x 24.00	152 x 102 x 610	4.25	108	16	7	7
--	6436 G NK	--	--	6.00 x 4.00 x 36.00	152 x 102 x 914	4.25	108	16	11	11
--	6448 G NK	--	--	6.00 x 4.00 x 48.00	152 x 102 x 1219	4.25	108	16	15	15
--	6460 G NK	--	--	6.00 x 4.00 x 60.00	152 x 102 x 1524	4.25	108	16	19	19
--	6472 G NK	--	--	6.00 x 4.00 x 72.00	152 x 102 x 1829	4.25	108	16	23	23
--	64120 G NK	--	--	6.00 x 4.00 x 120.00	152 x 102 x 3048	4.25	108	16	39	39
6612 G	6612 G NK	6612 GGV	6612 GGV NK	6.00 x 6.00 x 12.00	152 x 152 x 305	4.25	108	16	3	3
6618 G	6618 G NK	--	6618 GGV NK	6.00 x 6.00 x 18.00	152 x 152 x 457	4.25	108	16	5	5
6624 G	6624 G NK	6624 GGV	6624 GGV NK	6.00 x 6.00 x 24.00	152 x 152 x 610	4.25	108	16	7	7
6636 G	6636 G NK	6636 GGV	6636 GGV NK	6.00 x 6.00 x 36.00	152 x 152 x 914	4.25	108	16	11	11
6648 G	6648 G NK	6648 GGV	6648 GGV NK	6.00 x 6.00 x 48.00	152 x 152 x 1219	4.25	108	16	15	15
6660 G	6660 G NK	6660 GGV	6660 GGV NK	6.00 x 6.00 x 60.00	152 x 152 x 1524	4.25	108	16	19	19
6672 G	6672 G NK	6672 GGV	6672 GGV NK	6.00 x 6.00 x 72.00	152 x 152 x 1829	4.25	108	16	23	23
66120 G	66120 G NK	66120 GGV	66120 GGV NK	6.00 x 6.00 x 120.00	152 x 152 x 3048	4.25	108	16	39	39
8812 G	8812 G NK	8812 GGV	8812 GGV NK	8.00 x 8.00 x 12.00	203 x 203 x 305	6.00	152	14	3	3
8818 G	8818 G NK	--	8818 GGV NK	8.00 x 8.00 x 18.00	203 x 203 x 457	6.00	152	14	5	5
8824 G	8824 G NK	8824 GGV	8824 GGV NK	8.00 x 8.00 x 24.00	203 x 203 x 610	6.00	152	14	7	7
8836 G	8836 G NK	8836 GGV	8836 GGV NK	8.00 x 8.00 x 36.00	203 x 203 x 914	6.00	152	14	11	11
8848 G	8848 G NK	8848 GGV	8848 GGV NK	8.00 x 8.00 x 48.00	203 x 203 x 1219	6.00	152	14	15	15
8860 G	8860 G NK	8860 GGV	8860 GGV NK	8.00 x 8.00 x 60.00	203 x 203 x 1524	6.00	152	14	19	19
8872 G	8872 G NK	8872 GGV	8872 GGV NK	8.00 x 8.00 x 72.00	203 x 203 x 1829	6.00	152	14	23	23
88120 G	88120 G NK	88120 GGV	88120 GGV NK	8.00 x 8.00 x 120.00	203 x 203 x 3048	6.00	152	14	39	39

See page 10 for 10"x10" and 12"x12" wireway.

Notes: Dimensions are in inches. Millimeters shown are for reference only. Data subject to change without notice.

Cable & Wire Management

Lay-In Wireway Type 1 Screw Cover - Painted & Galvanized Illustration Sheet and Catalog Number

Subclass: Painted - AK1 & Galvanized - Z40

Wireway Catalog Number				Wireway Size			D		Knockout Quantity	
Painted		Galvanized		Height x Depth x Length Ax B x C		in.	mm	Gauge	Top	Bottom
KO	No KO	KO	No KO	in.	mm					
101012 G	101012 G NK	--	101012 GGV NK	10.00 x 10.00 x 12.00	254 x 254 x 305	8.00	203	14	3	3
101024 G	101024 G NK	--	101024 GGV NK	10.00 x 10.00 x 24.00	254 x 254 x 610	8.00	203	14	7	7
101036 G	101036 G NK	--	101036 GGV NK	10.00 x 10.00 x 36.00	254 x 254 x 914	8.00	203	14	11	11
101048 G	101048 G NK	--	101048 GGV NK	10.00 x 10.00 x 48.00	254 x 254 x 1219	8.00	203	14	15	15
101060 G	101060 G NK	--	101060 GGV NK	10.00 x 10.00 x 60.00	254 x 254 x 1524	8.00	203	14	19	19
101072 G	101072 G NK	--	101072 GGV NK	10.00 x 10.00 x 72.00	254 x 254 x 1829	8.00	203	14	23	23
1010120 G	1010120 G NK	--	1010120 GGV NK	10.00 x 10.00 x 120.00	254 x 254 x 3048	8.00	203	14	39	39
121212 G	121212 G NK	--	121212 GGV NK	12.00 x 12.00 x 12.00	305 x 305 x 305	10.00	254	14	3	3
121224 G	121224 G NK	--	121224 GGV NK	12.00 x 12.00 x 24.00	305 x 305 x 610	10.00	254	14	7	7
121236 G	121236 G NK	--	121236 GGV NK	12.00 x 12.00 x 36.00	305 x 305 x 914	10.00	254	14	11	11
121248 G	121248 G NK	--	121248 GGV NK	12.00 x 12.00 x 48.00	305 x 305 x 1219	10.00	254	14	15	15
121260 G	121260 G NK	--	121260 GGV NK	12.00 x 12.00 x 60.00	305 x 305 x 1524	10.00	254	14	19	19
121272 G	121272 G NK	--	121272 GGV NK	12.00 x 12.00 x 72.00	305 x 305 x 1829	10.00	254	14	23	23
1212120 G	1212120 G NK	--	1212120 GGV NK	12.00 x 12.00 x 120.00	305 x 305 x 3048	10.00	254	14	39	39

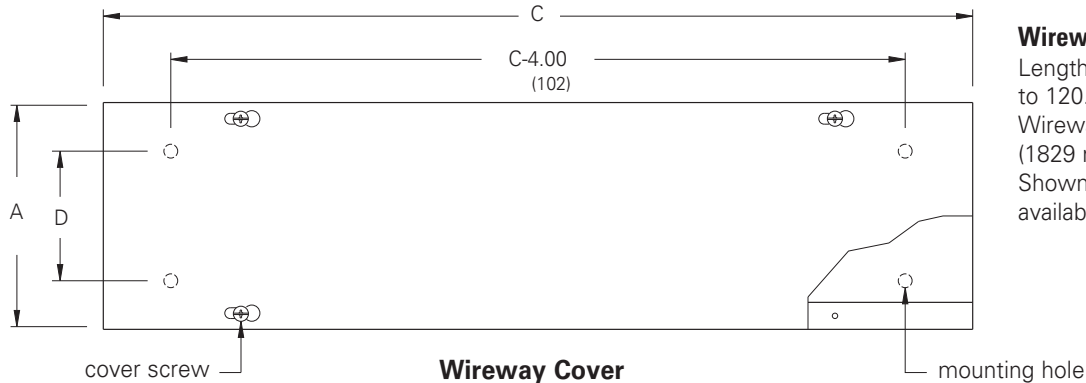

Wireway Section

Lengths from 12.00" (305 mm) to 120.00" (3048 mm). Wireway exceeding 72.00" (1829 mm) has two covers. Shown with KO's, also available without.

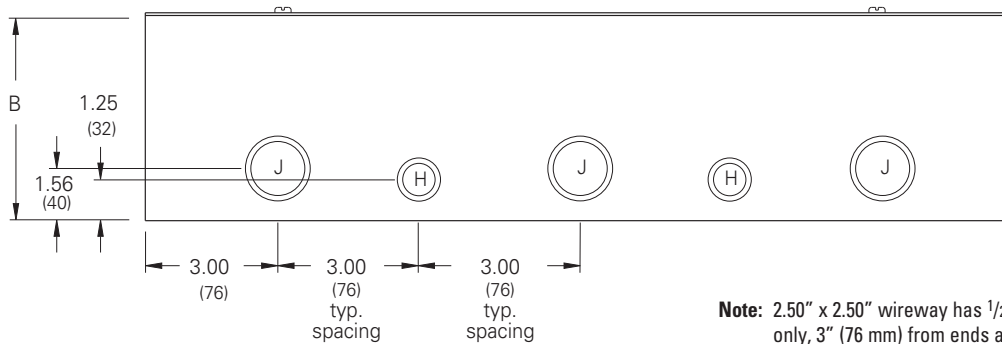

Knockout sizes:
H = 3/4" or 1/2" conduit
J = 1 1/4" or 1" conduit

Note: 2.50" x 2.50" wireway has 1/2" and 3/4" 2-way knockouts (H) only, 3" (76 mm) from ends and 3" (76 mm) on center. Additional mounting holes are furnished when C dimension is over 60.00" (1524 mm).

Notes: Dimensions are in inches. Millimeters shown are for reference only. Data subject to change without notice.

Lay-In Wireway Type 1 Screw Cover - Painted & Galvanized Illustration Sheet and Catalog Number

Subclass: Painted - AK1 & Galvanized - Z40

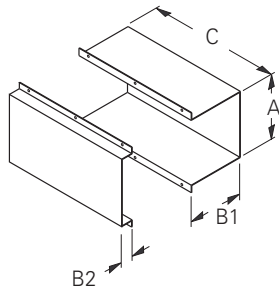

Telescopic Fitting

Adjustable length up to 10.00" (254 mm). Wraps around the two near joining wireway lengths to achieve a continuous run.

End

Used to terminate wireway or fitting. 2.50" x 2.50" (64 mm x 64 mm) through 8.00" x 8.00" (203 mm x 203 mm) ends have a 1.50"-1.25" concentric 2-way KO. 10.00" x 10.00" (254 mm x 254 mm) ends and larger have a 3.00" - 2.50" concentric 2-way KO for terminating on pipe or conduit. Also available without KO.

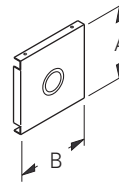

Telescopic Fitting

Catalog Number		A		B1		B2		C	
Painted	Galvanized	in.	mm	in.	mm	in.	mm	in.	mm
22 FTF	22 FTFGV	2.75	70	1.75	44	1.12	28	12.00	305
33 FTF	--	3.25	83	2.25	57	1.12	28	12.00	305
44 FTF	44 FTFGV	4.25	108	3.25	83	1.12	28	12.00	305
64 FTF	--	6.25	159	3.25	83	1.12	28	12.00	305
66 FTF	66 FTFGV	6.25	159	5.25	133	1.12	28	12.00	305
88 FTF	88 FTFGV	8.25	210	7.25	184	1.12	28	12.00	305
1010 FTF	1010 FTFGV	10.25	260	9.25	235	1.12	28	12.00	305
1212 FTF	1212 FTFGV	12.25	311	11.25	286	1.12	28	12.00	305

End

Catalog Number				A		B		
KO	Painted		Galvanized		in.	mm	in.	mm
	No KO	KO	No KO	KO				
22 E	22 E NK	22 EGV	22 EGV NK	2.50	64	2.50	64	
33 E	33 E NK	--	--	3.00	76	3.00	76	
44 E	44 E NK	44 EGV	44 EGV NK	4.00	102	4.00	102	
64 E	64 E NK	--	--	6.00	152	4.00	102	
66 E	66 E NK	66 EGV	66 EGV NK	6.00	152	6.00	152	
88 E	88 E NK	88 EGV	88 EGV NK	8.00	203	8.00	203	
1010 E	1010 E NK	1010 EGV	1010 EGV NK	10.00	254	10.00	254	
1212 E	1212 E NK	1212 EGV	1212 EGV NK	12.00	305	12.00	305	

See drawing for KO sizes.

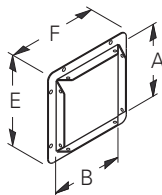

Wireway End Flange

Allows for a secure connection of wireway to an adjoining enclosure or wall.

Wireway End Flange

Catalog Number		A		B		E		F	
Painted	Galvanized	in.	mm	in.	mm	in.	mm	in.	mm
22 GF	22 GFGV	2.50	64	2.50	64	4.00	102	4.00	102
33 GF	--	3.00	76	3.00	76	4.50	114	4.50	114
44 GF	44 GFGV	4.00	102	4.00	102	5.50	140	5.50	140
64 GF	--	6.00	152	4.00	102	7.50	191	5.50	140
66 GF	66 GFGV	6.00	152	6.00	152	7.50	191	7.50	191
88 GF	88 GFGV	8.00	203	8.00	203	9.50	241	9.50	241
1010 GF	1010 GFGV	10.00	254	10.00	254	11.50	292	11.50	292
1212 GF	1212 GFGV	12.00	305	12.00	305	13.50	343	13.50	343

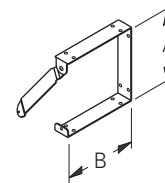

Connector

Swing gate allows for lay-in of wire and cable.

Connector

Catalog Number	A		B	
Galvanized	in.	mm	in.	mm
22 C	2.50	64	2.50	64
33 C	3.00	76	3.00	76
44 C	4.00	102	4.00	102
64 C	6.00	152	4.00	102
66 C	6.00	152	6.00	152
88 C	8.00	203	8.00	203
1010 C	10.00	254	10.00	254
1212 C	12.00	305	12.00	305

Notes: Dimensions are in inches. Millimeters shown are for reference only. Data subject to change without notice.

Cable & Wire Management

Lay-In Wireway Type 1 Screw Cover - Painted & Galvanized Illustration Sheet and Catalog Number

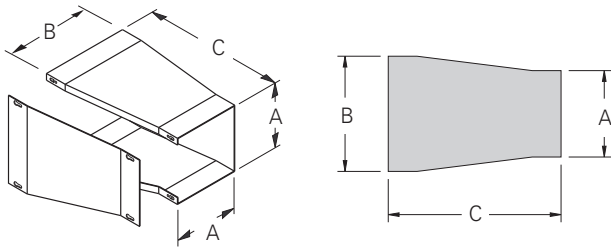

Reducer

B dimensions (see catalog table), correspond to the large end opening. Used to reduce or enlarge wireway runs.

Catalog Number		A		B		C	
Painted	Galvanized	in.	mm	in.	mm	in.	mm
2233 FR	--	2.50	64	3.00	76	6.00	152
3344 FR	--	3.00	76	4.00	102	8.00	203
4466 FR	--	4.00	102	6.00	152	10.00	254
6688 FR	--	6.00	152	8.00	203	12.00	305
881010 FR	--	8.00	203	10.00	254	12.00	305
10101212 FR	--	10.00	254	12.00	305	16.00	406

Wireway Hangers

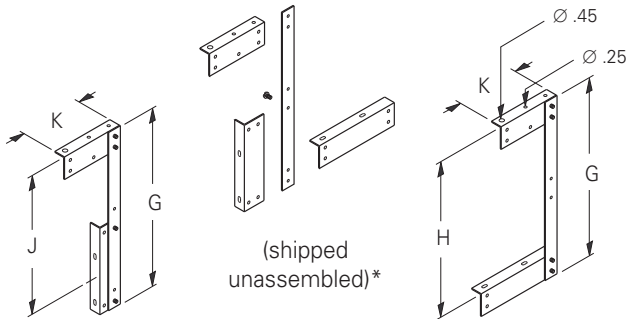

(shipped unassembled)*

Side Cover Assembly

For those installations where the wireway cover must be removed from the side.

Top Cover Assembly

For those installations where the wireway cover must be removed from the top.

Catalog Number		G		H		J		K	
Painted	Galvanized	in.	mm	in.	mm	in.	mm	in.	mm
22 FH	--	8.50	216	6.50	165	6.50	165	2.87	73
33 FH	--	10.50	267	8.50	216	9.00	229	3.87	98
44 FH	--	12.50	318	10.50	267	10.37	263	4.87	124
66 FH	--	16.50	419	14.50	368	13.50	343	5.87	149
88 FH	--	20.50	521	18.50	470	16.75	425	6.87	174
1010 FH*	--	24.50	622	22.50	572	19.75	502	7.87	200
1212 FH*	--	28.50	724	26.50	673	22.75	578	8.87	225

*Hangers are shipped welded in the top cover assembly position.

Subclass: Painted - AK1 & Galvanized - Z40

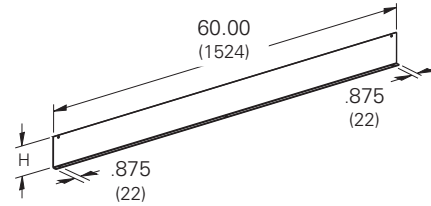

Barrier, Bolt-On

For those installations that require separated wiring compartments.

Barrier Kit, 60" Bolt-On

Catalog Number	Size		Length		H	
	in.	mm	in.	mm	in.	mm
22-12BK*	2.50 x 2.50	64 x 64	60.00	1524	1.88	48
33-12BK*	3.00 x 3.00	76 x 76	60.00	1524	2.25	57
44-12BK*	4.00 x 4.00	102 x 102	60.00	1524	3.00	76
66-12BK*	6.00 x 6.00	152 x 152	60.00	1524	4.50	114
88-12BK*	8.00 x 8.00	203 x 203	60.00	1524	6.00	152
1010-12BK*	10.00 x 10.00	254 x 254	60.00	1524	8.00	203
1212-12BK*	12.00 x 12.00	305 x 305	60.00	1524	10.50	267

*Not UL or CSA listed fitting.

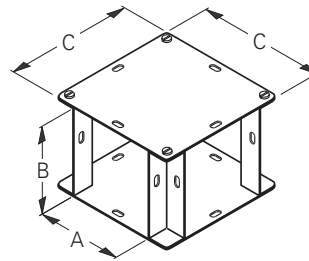

90° Elbow-Tee-Cross

Designed for left or right 90° turns or as a tee or cross by removing closure plates. Includes two (2) closure plates and hardware.

90° Elbow - Tee - Cross

Catalog Number		A		B		C	
Painted	Galvanized	in.	mm	in.	mm	in.	mm
22 LTX	22 LTXGV	2.50	64	2.50	64	4.50	114
33 LTX	--	3.00	76	3.00	76	5.00	127
44 LTX	44 LTXGV	4.00	102	4.00	102	6.00	152
64 LTX	--	6.00	152	4.00	102	8.00	203
66 LTX	66 LTXGV	6.00	152	6.00	152	8.00	203
88 LTX	88 LTXGV	8.00	203	8.00	203	10.00	254
1010 LTX	1010 LTXGV	10.00	254	10.00	254	12.00	305
1212 LTX	1212 LTXGV	12.00	305	12.00	305	14.00	356

Notes: Dimensions are in inches. Millimeters shown are for reference only. Data subject to change without notice.

Lay-In Wireway Type 1 - Painted & Galvanized Illustration Sheet and Catalog Number

**Wireway 90° Elbows
Screw Cover**

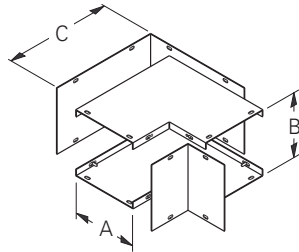
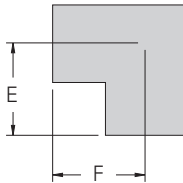

Combo Opening

Specially designed for removing either the inside or outside cover to allow a continuous run with 90° turns.

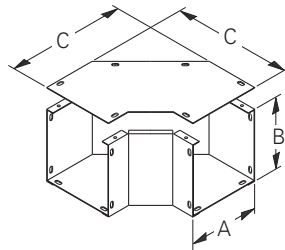
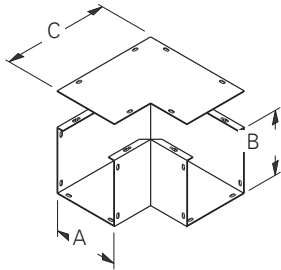

Sweep Elbow

Side cover design with a larger radius for 90° sweeping turns.

Side Opening

Side cover is removable to allow a continuous run on designs with 90° turns.

**Wireway 90° Elbows
Hinged Cover**

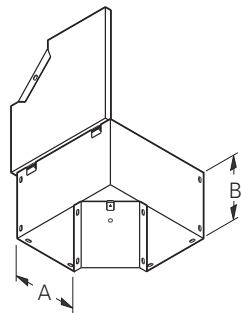
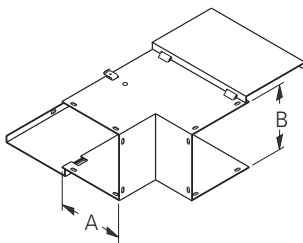

Side Opening

Side cover is hinged to allow a continuous run on designs with 90° sweeping turns.

Outside Opening

Specifically designed to have the outside covers hinge open to allow a continuous run with 90° turns.

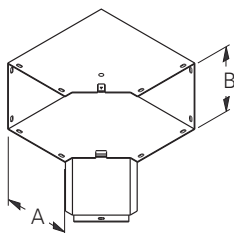

Inside Opening

Specifically designed to have only the inside cover hinge open to allow a continuous run with 90° turns.

Subclass: Painted - AK1 & Galvanized - Z40

90° Elbow - Screw Cover

Catalog Number		A		B		C		E		F	
Painted	Galvanized	in.	mm	in.	mm	in.	mm	in.	mm	in.	mm
22 L COMBO	22 L COMBOGV	2.50	64	2.50	64	5.59	142	4.28	109	4.28	109
33 L COMBO	--	3.00	76	3.00	76	6.09	155	4.50	114	4.50	114
44 L COMBO	44 L COMBOGV	4.00	102	4.00	102	7.09	180	5.00	127	5.00	127
64 L COMBO	--	4.00	102	6.00	152	10.09	256	5.00	127	5.00	127
66 L COMBO	66 L COMBOGV	6.00	152	6.00	152	10.09	256	7.00	178	7.00	178
88 L COMBO	88 L COMBOGV	8.00	203	8.00	203	12.09	307	8.00	203	8.00	203
1010 L COMBO	1010 L COMBOGV	10.00	254	10.00	254	14.09	358	9.00	229	9.00	229
1212 L COMBO	1212 L COMBOGV	12.00	305	12.00	305	16.09	409	10.00	254	10.00	254
22 L SIDE	--	2.50	64	2.50	64	5.59	142	4.28	109	4.28	109
33 L SIDE	--	3.00	76	3.00	76	6.09	155	4.50	114	4.50	114
44 L SIDE	--	4.00	102	4.00	102	7.09	180	5.00	127	5.00	127
64 L SIDE	--	6.00	152	4.00	102	10.09	256	7.00	178	7.00	178
66 L SIDE	--	6.00	152	6.00	152	10.09	256	7.00	178	7.00	178
88 L SIDE	--	8.00	203	8.00	203	12.09	307	8.00	203	8.00	203
1010 L SIDE	--	10.00	254	10.00	254	14.09	358	10.00	254	9.00	229
1212 L SIDE	--	12.00	305	12.00	305	16.09	409	10.00	254	10.00	254
22 L SWEEP	22 L SWEEP GV	2.50	64	2.50	64	5.63	143	4.25	108	4.25	108
33 L SWEEP	--	3.00	76	3.00	76	8.41	214	6.84	174	6.84	174
44 L SWEEP	44 L SWEEP GV	4.00	102	4.00	102	9.41	239	7.34	186	7.34	186
64 L SWEEP	--	6.00	152	4.00	102	11.41	290	8.34	212	8.34	212
66 L SWEEP	66 L SWEEP GV	6.00	152	6.00	152	11.41	290	8.34	212	8.34	212
88 L SWEEP	88 L SWEEP GV	8.00	203	8.00	203	13.41	341	9.34	237	9.34	237
1010 L SWEEP	1010 L SWEEP GV	10.00	254	10.00	254	15.41	391	10.34	263	10.34	263
1212 L SWEEP	1212 L SWEEP GV	12.00	305	12.00	305	17.41	442	11.34	288	11.34	288

90° Elbow - Hinged Cover

Catalog Number		A		B		E		F	
Painted		in.	mm	in.	mm	in.	mm	in.	mm
33 FL IN		3.00	76	3.00	76	5.50	140	5.50	140
44 FL IN		4.00	102	4.00	102	6.00	152	6.00	152
66 FL IN		6.00	152	6.00	152	7.00	178	7.00	178
88 FL IN		8.00	203	8.00	203	8.00	203	8.00	203
1010 FL IN		10.00	254	10.00	254	9.00	229	9.00	229
1212 FL IN		12.00	305	12.00	305	10.00	254	10.00	254
33 FL OUT		3.00	76	3.00	76	5.50	140	5.50	140
44 FL OUT		4.00	102	4.00	102	6.00	152	6.00	152
66 FL OUT		6.00	152	6.00	152	7.00	178	7.00	178
88 FL OUT		8.00	203	8.00	203	8.00	203	8.00	203
1010 FL OUT		10.00	254	10.00	254	9.00	229	9.00	229
1212 FL OUT		12.00	305	12.00	305	10.00	254	10.00	254
33 FL SIDE		3.00	76	3.00	76	5.50	140	5.50	140
44 FL SIDE		4.00	102	4.00	102	6.00	152	6.00	152
66 FL SIDE		6.00	152	6.00	152	7.00	178	7.00	178
88 FL SIDE		8.00	203	8.00	203	8.00	203	8.00	203
1010 FL SIDE		10.00	254	10.00	254	9.00	229	9.00	229
1212 FL SIDE		12.00	305	12.00	305	10.00	254	10.00	254

Notes: Dimensions are in inches. Millimeters shown are for reference only. Data subject to change without notice.

Lay-In Wireway Type 1 Screw Cover - Painted & Galvanized Illustration Sheet and Catalog Number

Subclass: Painted - AK1 & Galvanized - Z40

Wireway 45° Elbows

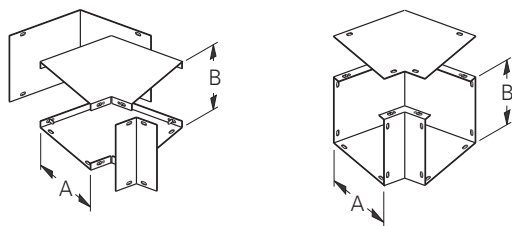

Combo Opening

Similar to the 90° elbow design except a 45° turn. Both inside and outside covers removable.

Side Opening

Similar to the 90° side opening design except for a 45° turn. Excellent for combining two to make a gradual sweeping 90° turn.

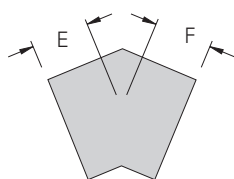

Tee

Side cover design where a "T" junction is necessary.

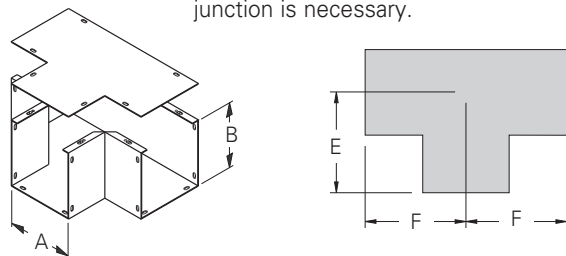

Cross

Side cover and broad body design to junction cable run in four directions.

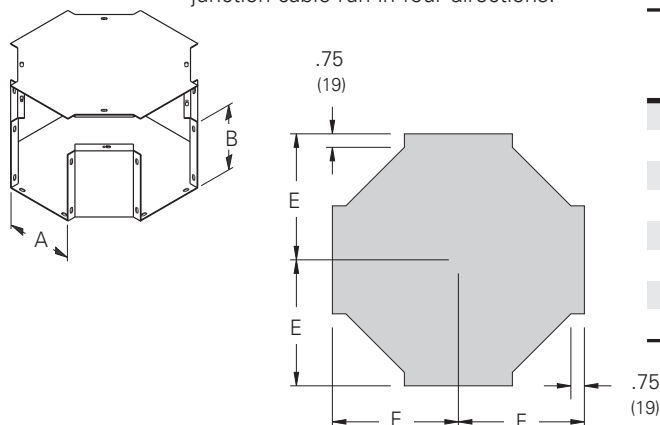

45° Elbow

Catalog Number		A		B		E		F	
Painted	Galvanized	in.	mm	in.	mm	in.	mm	in.	mm
2245 L COMBO	2245 L COMBOGV	2.50	64	2.50	64	1.72	44	1.72	44
3345 L COMBO	--	3.00	76	3.00	76	2.56	65	2.56	65
4445 L COMBO	4445 L COMBOGV	4.00	102	4.00	102	2.75	70	2.75	70
6445 L COMBO	--	4.00	102	6.00	153	2.75	70	2.75	70
6645 L COMBO	6645 L COMBOGV	6.00	153	6.00	153	3.18	81	3.18	81
8845 L COMBO	8845 L COMBOGV	8.00	203	8.00	203	3.62	92	3.62	92
101045 L COMBO	101045 L COMBOGV	10.00	254	10.00	254	4.06	103	4.06	103
121245 L COMBO	121245 L COMBOGV	12.00	305	12.00	305	4.50	114	4.50	114
2245 L SIDE	--	2.50	64	2.50	64	1.97	50	1.97	50
3345 L SIDE	--	3.00	76	3.00	76	2.56	65	2.56	65
4445 L SIDE	--	4.00	102	4.00	102	2.75	70	2.75	70
6445 L SIDE	--	6.00	153	4.00	102	3.18	81	3.18	81
6645 L SIDE	--	6.00	153	6.00	153	3.18	81	3.18	81
8845 L SIDE	--	8.00	203	8.00	203	3.62	92	3.62	92
101045 L SIDE	--	10.00	254	10.00	254	4.06	103	4.06	103
121245 L SIDE	--	12.00	305	12.00	305	4.50	114	4.50	114

Tee

Catalog Number		A		B		E		F	
Painted	Galvanized	in.	mm	in.	mm	in.	mm	in.	mm
22 T	22 TGV	2.50	64	2.50	64	4.25	108	4.25	108
33 T	--	3.00	76	3.00	76	4.50	114	4.50	114
44 T	44 TGV	4.00	102	4.00	102	5.00	127	5.00	127
64 T	--	6.00	153	4.00	102	7.00	178	7.00	178
66 T	66 TGV	6.00	153	6.00	153	7.00	178	7.00	178
88 T	88 TGV	8.00	203	8.00	203	8.00	203	8.00	203
1010 T	1010 TGV	10.00	254	10.00	254	9.00	229	9.00	229
1212 T	1212 TGV	12.00	305	12.00	305	10.00	254	10.00	254

Cross

Catalog Number		A		B		E		F	
Painted	Galvanized	in.	mm	in.	mm	in.	mm	in.	mm
22 X	22 XGV	2.50	64	2.50	64	4.25	108	4.25	108
33 X	--	3.00	76	3.00	76	5.62	143	5.62	143
44 X	44 XGV	4.00	102	4.00	102	6.12	155	6.12	155
64 X	--	6.00	152	4.00	102	7.12	181	7.12	181
66 X	66 XGV	6.00	152	6.00	152	7.12	181	7.12	181
88 X	88 XGV	8.00	203	8.00	203	8.12	206	8.12	206
1010 X	1010 XGV	10.00	254	10.00	254	9.12	232	9.12	232
1212 X	1212 XGV	12.00	305	12.00	305	10.12	257	10.12	257

Notes: Dimensions are in inches. Millimeters shown are for reference only. Data subject to change without notice.

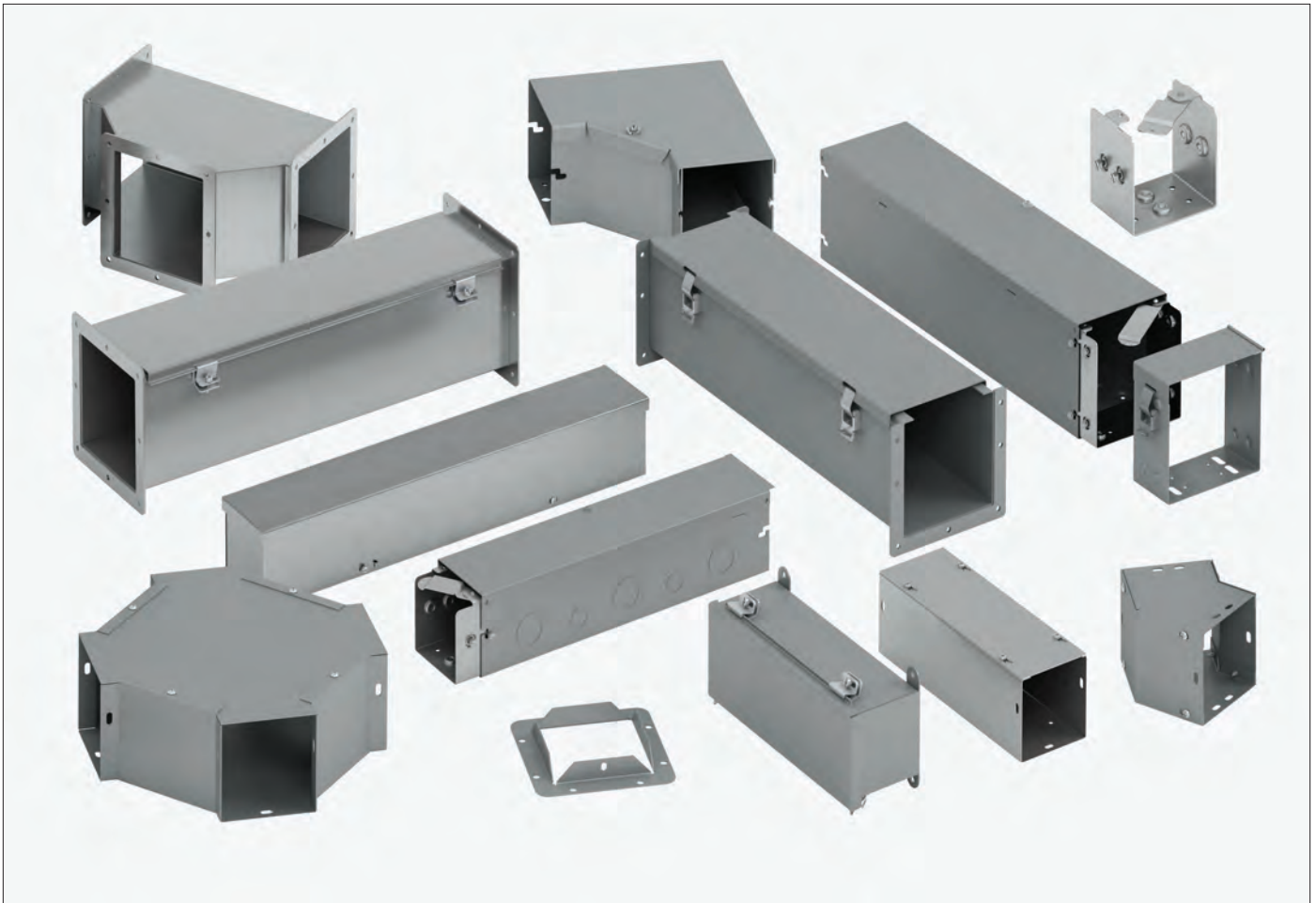

Lay-In Wireway Type 1 Screw Cover	8-14
Lay-In Wireway Type 1 Quick-Connect Hinge Cover	15-20
Lay-In Wireway Type 3R EnviroShield™	21-24
Lay-In Wireway Type 12	25-31
Feed-Through Wireway Type 12	32-35
Feed-Through Wireway Type 4X	36-39
Wiring Trough Type 1 Screw Cover	40-41
Wiring Trough Type 3R Screw Cover	42-43
Wiring Trough Type 12 Lift-Off Cover	44-45
Wiring Trough Type 4X Lift-Off Cover	46-47

Lay-In Wireway Type 1 Screw Cover - Painted & Galvanized Data Sheet

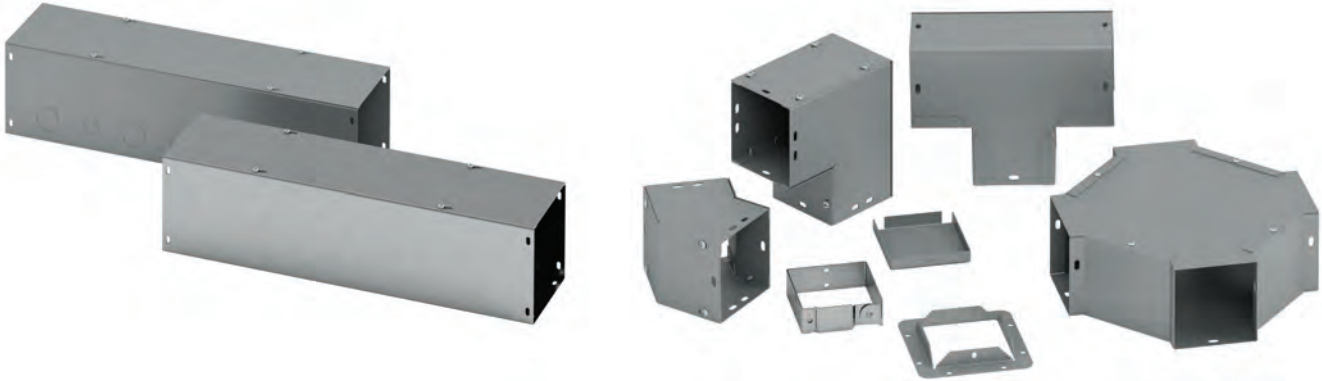

Application

- Houses runs of control and power cable
- Used for cable and wire junction, distribution and termination

Standards

- UL 870 listed, Type 1
- CSA C22.2 No. 26 certified, Type 1
- Conforms to NEMA standard for Type 1

Finish

- Wash and phosphate undercoat or galvanized steel
- ANSI 61 gray acrylic electrocoat finish

Accessories

- Sealing devices
- Touch-up paint
- See Accessories section

Construction

- Wireway body and cover are fabricated from code gauge steel or galvanized steel, (see table, pages 9 & 10)
- Wireway body has mounting holes on the back
- Wireway is available with or without knockouts
- Wireway fittings have no knockouts, ends are available with or without knockouts
- Cover is secured to the body with plated screws
- Keyhole slots are furnished on the wireway cover which allow easy access to the inside without removing the screws
- Wireway exceeding 72 inches in length has two overlapping covers
- Variety of fittings allow runs which can change direction, junction and terminate
- Standard wireway connectors (sold separately) have a gate feature which can swing completely open allowing for lay-in of wire and cable
- Interchangeable with Type 1 Hinge Cover Wireway and Fittings when HSCA connector is used, (see page 17)

Discount Schedule: A2

Subclass: AK1 (painted) & Z40 (galvanized)

Notes: We can provide special sizes, finishes and other modifications. Consult the factory for your special requirements.

Lay-In Wireway Type 1 Screw Cover - Painted & Galvanized Catalog Number

Subclass: Painted - AK1 & Galvanized - Z40

Wireway Catalog Number				Wireway Size				Gauge	Knockout Quantity	
Painted		Galvanized		Height x Depth x Length A x B x C		D			Top	Bottom
KO	No KO	KO	No KO	in.	mm	in.	mm			
2212 G	2212 G NK	--	2212 GGV NK	2.50 x 2.50 x 12.00	64 x 64 x 305	1.25	32	16	3	3
2224 G	2224 G NK	2224 GGV	2224 GGV NK	2.50 x 2.50 x 24.00	64 x 64 x 610	1.25	32	16	7	7
2236 G	2236 G NK	2236 GGV	2236 GGV NK	2.50 x 2.50 x 36.00	64 x 64 x 914	1.25	32	16	11	11
2248 G	2248 G NK	--	2248 GGV NK	2.50 x 2.50 x 48.00	64 x 64 x 1219	1.25	32	16	15	15
2260 G	2260 G NK	2260 GGV	2260 GGV NK	2.50 x 2.50 x 60.00	64 x 64 x 1524	1.25	32	16	23	23
22120 G	22120 G NK	22120 GGV	22120 GGV NK	2.50 x 2.50 x 120.00	64 x 64 x 3048	1.25	32	16	39	39
--	3312 G NK	--	--	3.00 x 3.00 x 12.00	76 x 76 x 305	1.50	38	16	3	3
--	3324 G NK	--	--	3.00 x 3.00 x 24.00	76 x 76 x 610	1.50	38	16	7	7
--	3336 G NK	--	--	3.00 x 3.00 x 36.00	76 x 76 x 914	1.50	38	16	11	11
--	3348 G NK	--	--	3.00 x 3.00 x 48.00	76 x 76 x 1219	1.50	38	16	15	15
--	3360 G NK	--	--	3.00 x 3.00 x 60.00	76 x 76 x 1524	1.50	38	16	19	19
--	3372 G NK	--	--	3.00 x 3.00 x 72.00	76 x 76 x 1829	1.50	38	16	23	23
--	33120 G NK	--	--	3.00 x 3.00 x 120.00	76 x 76 x 3048	1.50	38	16	39	39
4412 G	4412 G NK	4412 GGV	4412 GGV NK	4.00 x 4.00 x 12.00	102 x 102 x 305	2.75	70	16	3	3
4418 G	4418 G NK	--	4418 GGV NK	4.00 x 4.00 x 18.00	102 x 102 x 457	2.75	70	16	5	5
4424 G	4424 G NK	4424 GGV	4424 GGV NK	4.00 x 4.00 x 24.00	102 x 102 x 610	2.75	70	16	7	7
4436 G	4436 G NK	4436 GGV	4436 GGV NK	4.00 x 4.00 x 36.00	102 x 102 x 914	2.75	70	16	11	11
4448 G	4448 G NK	4448 GGV	4448 GGV NK	4.00 x 4.00 x 48.00	102 x 102 x 1219	2.75	70	16	15	15
4460 G	4460 G NK	4460 GGV	4460 GGV NK	4.00 x 4.00 x 60.00	102 x 102 x 1524	2.75	70	16	19	19
4472 G	4472 G NK	4472 GGV	4472 GGV NK	4.00 x 4.00 x 72.00	102 x 102 x 1829	2.75	70	16	23	23
44120 G	44120 G NK	44120 GGV	44120 GGV NK	4.00 x 4.00 x 120.00	102 x 102 x 3048	2.75	70	16	39	39
--	6412 G NK	--	--	6.00 x 4.00 x 12.00	152 x 102 x 305	4.25	108	16	3	3
--	6418 G NK	--	--	6.00 x 4.00 x 18.00	152 x 102 x 457	4.25	108	16	5	5
--	6424 G NK	--	--	6.00 x 4.00 x 24.00	152 x 102 x 610	4.25	108	16	7	7
--	6436 G NK	--	--	6.00 x 4.00 x 36.00	152 x 102 x 914	4.25	108	16	11	11
--	6448 G NK	--	--	6.00 x 4.00 x 48.00	152 x 102 x 1219	4.25	108	16	15	15
--	6460 G NK	--	--	6.00 x 4.00 x 60.00	152 x 102 x 1524	4.25	108	16	19	19
--	6472 G NK	--	--	6.00 x 4.00 x 72.00	152 x 102 x 1829	4.25	108	16	23	23
--	64120 G NK	--	--	6.00 x 4.00 x 120.00	152 x 102 x 3048	4.25	108	16	39	39
6612 G	6612 G NK	6612 GGV	6612 GGV NK	6.00 x 6.00 x 12.00	152 x 152 x 305	4.25	108	16	3	3
6618 G	6618 G NK	--	6618 GGV NK	6.00 x 6.00 x 18.00	152 x 152 x 457	4.25	108	16	5	5
6624 G	6624 G NK	6624 GGV	6624 GGV NK	6.00 x 6.00 x 24.00	152 x 152 x 610	4.25	108	16	7	7
6636 G	6636 G NK	6636 GGV	6636 GGV NK	6.00 x 6.00 x 36.00	152 x 152 x 914	4.25	108	16	11	11
6648 G	6648 G NK	6648 GGV	6648 GGV NK	6.00 x 6.00 x 48.00	152 x 152 x 1219	4.25	108	16	15	15
6660 G	6660 G NK	6660 GGV	6660 GGV NK	6.00 x 6.00 x 60.00	152 x 152 x 1524	4.25	108	16	19	19
6672 G	6672 G NK	6672 GGV	6672 GGV NK	6.00 x 6.00 x 72.00	152 x 152 x 1829	4.25	108	16	23	23
66120 G	66120 G NK	66120 GGV	66120 GGV NK	6.00 x 6.00 x 120.00	152 x 152 x 3048	4.25	108	16	39	39
8812 G	8812 G NK	8812 GGV	8812 GGV NK	8.00 x 8.00 x 12.00	203 x 203 x 305	6.00	152	14	3	3
8818 G	8818 G NK	--	8818 GGV NK	8.00 x 8.00 x 18.00	203 x 203 x 457	6.00	152	14	5	5
8824 G	8824 G NK	8824 GGV	8824 GGV NK	8.00 x 8.00 x 24.00	203 x 203 x 610	6.00	152	14	7	7
8836 G	8836 G NK	8836 GGV	8836 GGV NK	8.00 x 8.00 x 36.00	203 x 203 x 914	6.00	152	14	11	11
8848 G	8848 G NK	8848 GGV	8848 GGV NK	8.00 x 8.00 x 48.00	203 x 203 x 1219	6.00	152	14	15	15
8860 G	8860 G NK	8860 GGV	8860 GGV NK	8.00 x 8.00 x 60.00	203 x 203 x 1524	6.00	152	14	19	19
8872 G	8872 G NK	8872 GGV	8872 GGV NK	8.00 x 8.00 x 72.00	203 x 203 x 1829	6.00	152	14	23	23
88120 G	88120 G NK	88120 GGV	88120 GGV NK	8.00 x 8.00 x 120.00	203 x 203 x 3048	6.00	152	14	39	39

See page 10 for 10"x10" and 12"x12" wireway.

Notes: Dimensions are in inches. Millimeters shown are for reference only. Data subject to change without notice.

Cable & Wire Management

Lay-In Wireway Type 1 Screw Cover - Painted & Galvanized Illustration Sheet and Catalog Number

Subclass: Painted - AK1 & Galvanized - Z40

Wireway Catalog Number				Wireway Size			D		Knockout Quantity	
Painted		Galvanized		Height x Depth x Length Ax B x C		in.	mm	Gauge	Top	Bottom
KO	No KO	KO	No KO	in.	mm					
101012 G	101012 G NK	--	101012 GGV NK	10.00 x 10.00 x 12.00	254 x 254 x 305	8.00	203	14	3	3
101024 G	101024 G NK	--	101024 GGV NK	10.00 x 10.00 x 24.00	254 x 254 x 610	8.00	203	14	7	7
101036 G	101036 G NK	--	101036 GGV NK	10.00 x 10.00 x 36.00	254 x 254 x 914	8.00	203	14	11	11
101048 G	101048 G NK	--	101048 GGV NK	10.00 x 10.00 x 48.00	254 x 254 x 1219	8.00	203	14	15	15
101060 G	101060 G NK	--	101060 GGV NK	10.00 x 10.00 x 60.00	254 x 254 x 1524	8.00	203	14	19	19
101072 G	101072 G NK	--	101072 GGV NK	10.00 x 10.00 x 72.00	254 x 254 x 1829	8.00	203	14	23	23
1010120 G	1010120 G NK	--	1010120 GGV NK	10.00 x 10.00 x 120.00	254 x 254 x 3048	8.00	203	14	39	39
121212 G	121212 G NK	--	121212 GGV NK	12.00 x 12.00 x 12.00	305 x 305 x 305	10.00	254	14	3	3
121224 G	121224 G NK	--	121224 GGV NK	12.00 x 12.00 x 24.00	305 x 305 x 610	10.00	254	14	7	7
121236 G	121236 G NK	--	121236 GGV NK	12.00 x 12.00 x 36.00	305 x 305 x 914	10.00	254	14	11	11
121248 G	121248 G NK	--	121248 GGV NK	12.00 x 12.00 x 48.00	305 x 305 x 1219	10.00	254	14	15	15
121260 G	121260 G NK	--	121260 GGV NK	12.00 x 12.00 x 60.00	305 x 305 x 1524	10.00	254	14	19	19
121272 G	121272 G NK	--	121272 GGV NK	12.00 x 12.00 x 72.00	305 x 305 x 1829	10.00	254	14	23	23
1212120 G	1212120 G NK	--	1212120 GGV NK	12.00 x 12.00 x 120.00	305 x 305 x 3048	10.00	254	14	39	39

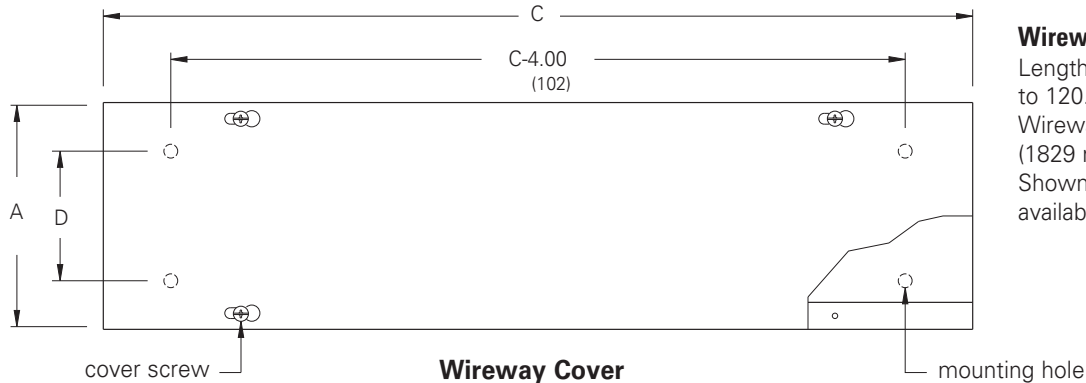

Wireway Section

Lengths from 12.00" (305 mm) to 120.00" (3048 mm). Wireway exceeding 72.00" (1829 mm) has two covers. Shown with KO's, also available without.

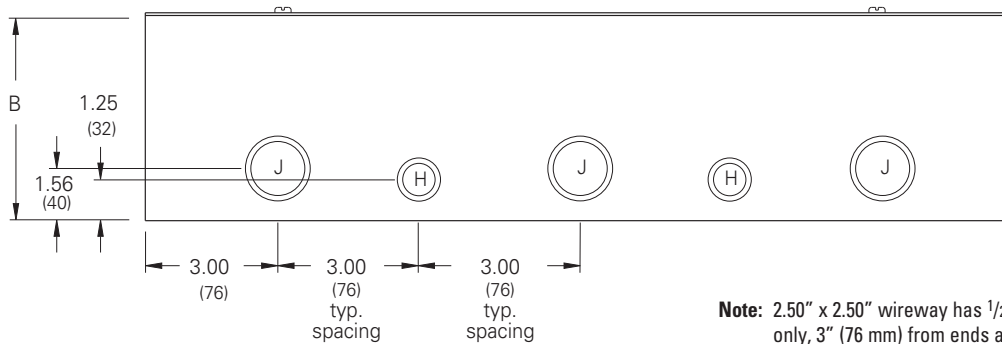

Knockout sizes:
H = 3/4" or 1/2" conduit
J = 1 1/4" or 1" conduit

Note: 2.50" x 2.50" wireway has 1/2" and 3/4" 2-way knockouts (H) only, 3" (76 mm) from ends and 3" (76 mm) on center. Additional mounting holes are furnished when C dimension is over 60.00" (1524 mm).

Notes: Dimensions are in inches. Millimeters shown are for reference only. Data subject to change without notice.

Lay-In Wireway Type 1 Screw Cover - Painted & Galvanized Illustration Sheet and Catalog Number

Subclass: Painted - AK1 & Galvanized - Z40

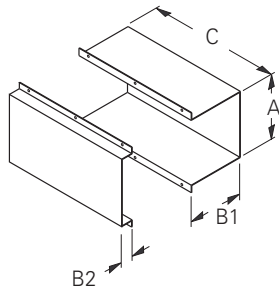

Telescopic Fitting

Adjustable length up to 10.00" (254 mm). Wraps around the two near joining wireway lengths to achieve a continuous run.

End

Used to terminate wireway or fitting. 2.50" x 2.50" (64 mm x 64 mm) through 8.00" x 8.00" (203 mm x 203 mm) ends have a 1.50"-1.25" concentric 2-way KO. 10.00" x 10.00" (254 mm x 254 mm) ends and larger have a 3.00" - 2.50" concentric 2-way KO for terminating on pipe or conduit. Also available without KO.

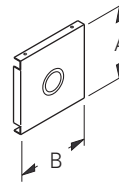

Telescopic Fitting

Catalog Number		A		B1		B2		C	
Painted	Galvanized	in.	mm	in.	mm	in.	mm	in.	mm
22 FTF	22 FTFGV	2.75	70	1.75	44	1.12	28	12.00	305
33 FTF	--	3.25	83	2.25	57	1.12	28	12.00	305
44 FTF	44 FTFGV	4.25	108	3.25	83	1.12	28	12.00	305
64 FTF	--	6.25	159	3.25	83	1.12	28	12.00	305
66 FTF	66 FTFGV	6.25	159	5.25	133	1.12	28	12.00	305
88 FTF	88 FTFGV	8.25	210	7.25	184	1.12	28	12.00	305
1010 FTF	1010 FTFGV	10.25	260	9.25	235	1.12	28	12.00	305
1212 FTF	1212 FTFGV	12.25	311	11.25	286	1.12	28	12.00	305

End

Catalog Number				A		B		
KO	Painted		Galvanized		in.	mm	in.	mm
	No KO	KO	No KO	KO				
22 E	22 E NK	22 EGV	22 EGV NK	2.50	64	2.50	64	
33 E	33 E NK	--	--	3.00	76	3.00	76	
44 E	44 E NK	44 EGV	44 EGV NK	4.00	102	4.00	102	
64 E	64 E NK	--	--	6.00	152	4.00	102	
66 E	66 E NK	66 EGV	66 EGV NK	6.00	152	6.00	152	
88 E	88 E NK	88 EGV	88 EGV NK	8.00	203	8.00	203	
1010 E	1010 E NK	1010 EGV	1010 EGV NK	10.00	254	10.00	254	
1212 E	1212 E NK	1212 EGV	1212 EGV NK	12.00	305	12.00	305	

See drawing for KO sizes.

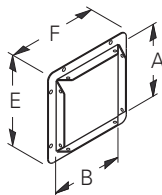

Wireway End Flange

Allows for a secure connection of wireway to an adjoining enclosure or wall.

Wireway End Flange

Catalog Number		A		B		E		F	
Painted	Galvanized	in.	mm	in.	mm	in.	mm	in.	mm
22 GF	22 GFGV	2.50	64	2.50	64	4.00	102	4.00	102
33 GF	--	3.00	76	3.00	76	4.50	114	4.50	114
44 GF	44 GFGV	4.00	102	4.00	102	5.50	140	5.50	140
64 GF	--	6.00	152	4.00	102	7.50	191	5.50	140
66 GF	66 GFGV	6.00	152	6.00	152	7.50	191	7.50	191
88 GF	88 GFGV	8.00	203	8.00	203	9.50	241	9.50	241
1010 GF	1010 GFGV	10.00	254	10.00	254	11.50	292	11.50	292
1212 GF	1212 GFGV	12.00	305	12.00	305	13.50	343	13.50	343

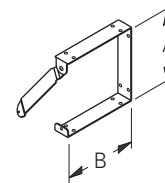

Connector

Swing gate allows for lay-in of wire and cable.

Connector

Catalog Number	A		B	
Galvanized	in.	mm	in.	mm
22 C	2.50	64	2.50	64
33 C	3.00	76	3.00	76
44 C	4.00	102	4.00	102
64 C	6.00	152	4.00	102
66 C	6.00	152	6.00	152
88 C	8.00	203	8.00	203
1010 C	10.00	254	10.00	254
1212 C	12.00	305	12.00	305

Notes: Dimensions are in inches. Millimeters shown are for reference only. Data subject to change without notice.

Cable & Wire Management

Lay-In Wireway Type 1 Screw Cover - Painted & Galvanized Illustration Sheet and Catalog Number

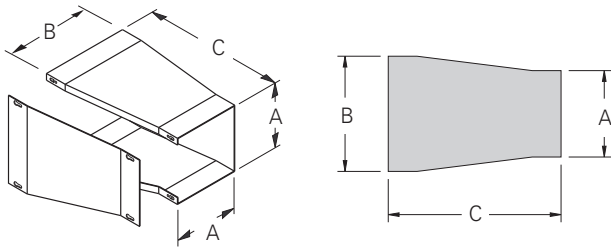

Reducer

B dimensions (see catalog table), correspond to the large end opening. Used to reduce or enlarge wireway runs.

Catalog Number		A		B		C	
Painted	Galvanized	in.	mm	in.	mm	in.	mm
2233 FR	--	2.50	64	3.00	76	6.00	152
3344 FR	--	3.00	76	4.00	102	8.00	203
4466 FR	--	4.00	102	6.00	152	10.00	254
6688 FR	--	6.00	152	8.00	203	12.00	305
881010 FR	--	8.00	203	10.00	254	12.00	305
10101212 FR	--	10.00	254	12.00	305	16.00	406

Wireway Hangers

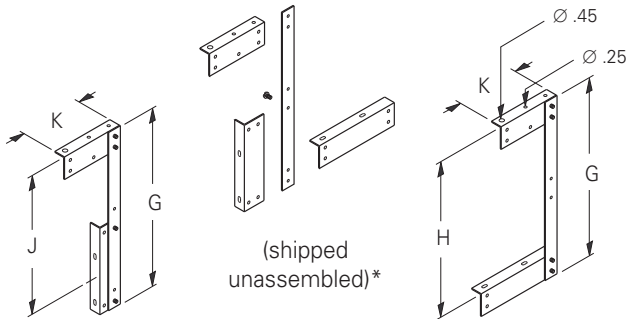

(shipped unassembled)*

Side Cover Assembly

For those installations where the wireway cover must be removed from the side.

Top Cover Assembly

For those installations where the wireway cover must be removed from the top.

Catalog Number		G		H		J		K	
Painted	Galvanized	in.	mm	in.	mm	in.	mm	in.	mm
22 FH	--	8.50	216	6.50	165	6.50	165	2.87	73
33 FH	--	10.50	267	8.50	216	9.00	229	3.87	98
44 FH	--	12.50	318	10.50	267	10.37	263	4.87	124
66 FH	--	16.50	419	14.50	368	13.50	343	5.87	149
88 FH	--	20.50	521	18.50	470	16.75	425	6.87	174
1010 FH*	--	24.50	622	22.50	572	19.75	502	7.87	200
1212 FH*	--	28.50	724	26.50	673	22.75	578	8.87	225

*Hangers are shipped welded in the top cover assembly position.

Subclass: Painted - AK1 & Galvanized - Z40

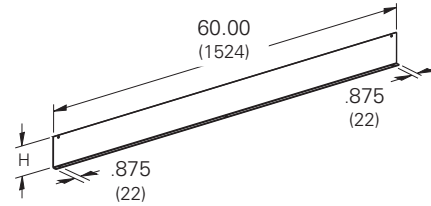

Barrier, Bolt-On

For those installations that require separated wiring compartments.

Catalog Number	Size		Length		H	
	in.	mm	in.	mm	in.	mm
22-12BK*	2.50 x 2.50	64 x 64	60.00	1524	1.88	48
33-12BK*	3.00 x 3.00	76 x 76	60.00	1524	2.25	57
44-12BK*	4.00 x 4.00	102 x 102	60.00	1524	3.00	76
66-12BK*	6.00 x 6.00	152 x 152	60.00	1524	4.50	114
88-12BK*	8.00 x 8.00	203 x 203	60.00	1524	6.00	152
1010-12BK*	10.00 x 10.00	254 x 254	60.00	1524	8.00	203
1212-12BK*	12.00 x 12.00	305 x 305	60.00	1524	10.50	267

*Not UL or CSA listed fitting.

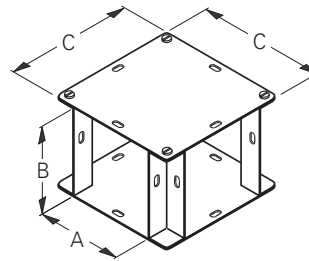

90° Elbow-Tee-Cross

Designed for left or right 90° turns or as a tee or cross by removing closure plates. Includes two (2) closure plates and hardware.

Catalog Number		A		B		C	
Painted	Galvanized	in.	mm	in.	mm	in.	mm
22 LTX	22 LTXGV	2.50	64	2.50	64	4.50	114
33 LTX	--	3.00	76	3.00	76	5.00	127
44 LTX	44 LTXGV	4.00	102	4.00	102	6.00	152
64 LTX	--	6.00	152	4.00	102	8.00	203
66 LTX	66 LTXGV	6.00	152	6.00	152	8.00	203
88 LTX	88 LTXGV	8.00	203	8.00	203	10.00	254
1010 LTX	1010 LTXGV	10.00	254	10.00	254	12.00	305
1212 LTX	1212 LTXGV	12.00	305	12.00	305	14.00	356

Notes: Dimensions are in inches. Millimeters shown are for reference only. Data subject to change without notice.

Lay-In Wireway Type 1 - Painted & Galvanized Illustration Sheet and Catalog Number

Subclass: Painted - AK1 & Galvanized - Z40

**Wireway 90° Elbows
Screw Cover**

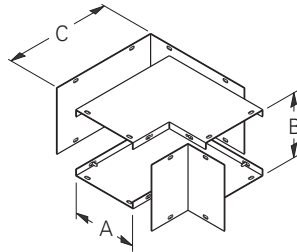
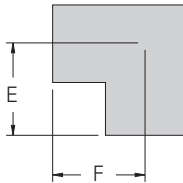

Combo Opening

Specially designed for removing either the inside or outside cover to allow a continuous run with 90° turns.

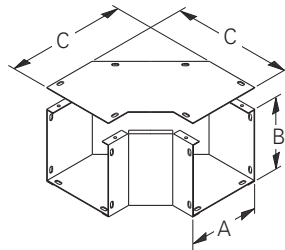
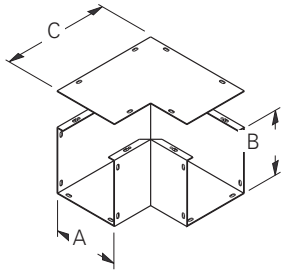

Side Opening

Side cover is removable to allow a continuous run on designs with 90° turns.

Sweep Elbow

Side cover design with a larger radius for 90° sweeping turns.

**Wireway 90° Elbows
Hinged Cover**

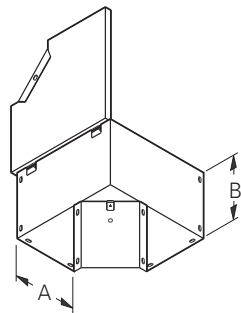
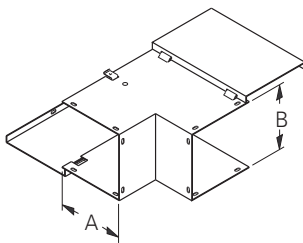

Outside Opening

Specifically designed to have the outside covers hinge open to allow a continuous run with 90° turns.

Side Opening

Side cover is hinged to allow a continuous run on designs with 90° sweeping turns.

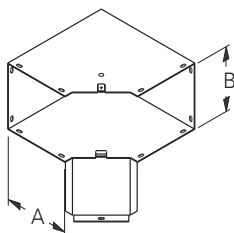

Inside Opening

Specifically designed to have only the inside cover hinge open to allow a continuous run with 90° turns.

90° Elbow - Screw Cover

Catalog Number		A		B		C		E		F	
Painted	Galvanized	in.	mm	in.	mm	in.	mm	in.	mm	in.	mm
22 L COMBO	22 L COMBOGV	2.50	64	2.50	64	5.59	142	4.28	109	4.28	109
33 L COMBO	--	3.00	76	3.00	76	6.09	155	4.50	114	4.50	114
44 L COMBO	44 L COMBOGV	4.00	102	4.00	102	7.09	180	5.00	127	5.00	127
64 L COMBO	--	4.00	102	6.00	152	10.09	256	5.00	127	5.00	127
66 L COMBO	66 L COMBOGV	6.00	152	6.00	152	10.09	256	7.00	178	7.00	178
88 L COMBO	88 L COMBOGV	8.00	203	8.00	203	12.09	307	8.00	203	8.00	203
1010 L COMBO	1010 L COMBOGV	10.00	254	10.00	254	14.09	358	9.00	229	9.00	229
1212 L COMBO	1212 L COMBOGV	12.00	305	12.00	305	16.09	409	10.00	254	10.00	254
22 L SIDE	--	2.50	64	2.50	64	5.59	142	4.28	109	4.28	109
33 L SIDE	--	3.00	76	3.00	76	6.09	155	4.50	114	4.50	114
44 L SIDE	--	4.00	102	4.00	102	7.09	180	5.00	127	5.00	127
64 L SIDE	--	6.00	152	4.00	102	10.09	256	7.00	178	7.00	178
66 L SIDE	--	6.00	152	6.00	152	10.09	256	7.00	178	7.00	178
88 L SIDE	--	8.00	203	8.00	203	12.09	307	8.00	203	8.00	203
1010 L SIDE	--	10.00	254	10.00	254	14.09	358	10.00	254	9.00	229
1212 L SIDE	--	12.00	305	12.00	305	16.09	409	10.00	254	10.00	254
22 L SWEEP	22 L SWEEPGV	2.50	64	2.50	64	5.63	143	4.25	108	4.25	108
33 L SWEEP	--	3.00	76	3.00	76	8.41	214	6.84	174	6.84	174
44 L SWEEP	44 L SWEEPGV	4.00	102	4.00	102	9.41	239	7.34	186	7.34	186
64 L SWEEP	--	6.00	152	4.00	102	11.41	290	8.34	212	8.34	212
66 L SWEEP	66 L SWEEPGV	6.00	152	6.00	152	11.41	290	8.34	212	8.34	212
88 L SWEEP	88 L SWEEPGV	8.00	203	8.00	203	13.41	341	9.34	237	9.34	237
1010 L SWEEP	1010 L SWEEPGV	10.00	254	10.00	254	15.41	391	10.34	263	10.34	263
1212 L SWEEP	1212 L SWEEPGV	12.00	305	12.00	305	17.41	442	11.34	288	11.34	288

90° Elbow - Hinged Cover

Catalog Number		A		B		E		F	
Painted		in.	mm	in.	mm	in.	mm	in.	mm
33 FL IN		3.00	76	3.00	76	5.50	140	5.50	140
44 FL IN		4.00	102	4.00	102	6.00	152	6.00	152
66 FL IN		6.00	152	6.00	152	7.00	178	7.00	178
88 FL IN		8.00	203	8.00	203	8.00	203	8.00	203
1010 FL IN		10.00	254	10.00	254	9.00	229	9.00	229
1212 FL IN		12.00	305	12.00	305	10.00	254	10.00	254
33 FL OUT		3.00	76	3.00	76	5.50	140	5.50	140
44 FL OUT		4.00	102	4.00	102	6.00	152	6.00	152
66 FL OUT		6.00	152	6.00	152	7.00	178	7.00	178
88 FL OUT		8.00	203	8.00	203	8.00	203	8.00	203
1010 FL OUT		10.00	254	10.00	254	9.00	229	9.00	229
1212 FL OUT		12.00	305	12.00	305	10.00	254	10.00	254
33 FL SIDE		3.00	76	3.00	76	5.50	140	5.50	140
44 FL SIDE		4.00	102	4.00	102	6.00	152	6.00	152
66 FL SIDE		6.00	152	6.00	152	7.00	178	7.00	178
88 FL SIDE		8.00	203	8.00	203	8.00	203	8.00	203
1010 FL SIDE		10.00	254	10.00	254	9.00	229	9.00	229
1212 FL SIDE		12.00	305	12.00	305	10.00	254	10.00	254

Notes: Dimensions are in inches. Millimeters shown are for reference only. Data subject to change without notice.

Lay-In Wireway Type 1 Screw Cover - Painted & Galvanized Illustration Sheet and Catalog Number

Subclass: Painted - AK1 & Galvanized - Z40

Wireway 45° Elbows

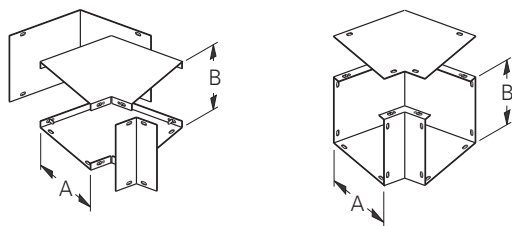

Combo Opening

Similar to the 90° elbow design except a 45° turn. Both inside and outside covers removable.

Side Opening

Similar to the 90° side opening design except for a 45° turn. Excellent for combining two to make a gradual sweeping 90° turn.

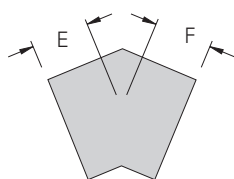

Tee

Side cover design where a "T" junction is necessary.

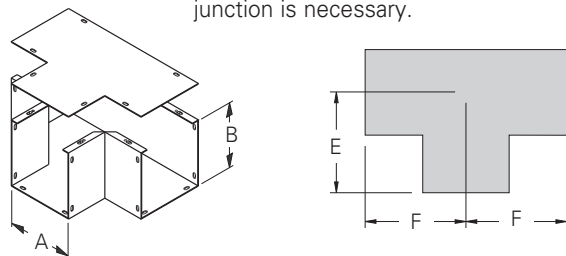

Cross

Side cover and broad body design to junction cable run in four directions.

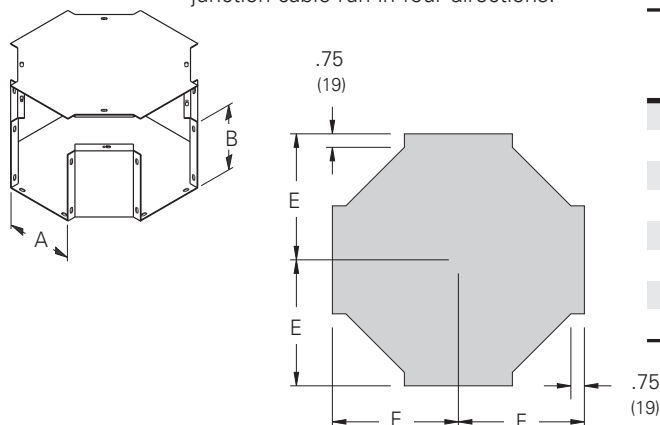

45° Elbow

Catalog Number		A		B		E		F	
Painted	Galvanized	in.	mm	in.	mm	in.	mm	in.	mm
2245 L COMBO	2245 L COMBOGV	2.50	64	2.50	64	1.72	44	1.72	44
3345 L COMBO	--	3.00	76	3.00	76	2.56	65	2.56	65
4445 L COMBO	4445 L COMBOGV	4.00	102	4.00	102	2.75	70	2.75	70
6445 L COMBO	--	4.00	102	6.00	153	2.75	70	2.75	70
6645 L COMBO	6645 L COMBOGV	6.00	153	6.00	153	3.18	81	3.18	81
8845 L COMBO	8845 L COMBOGV	8.00	203	8.00	203	3.62	92	3.62	92
101045 L COMBO	101045 L COMBOGV	10.00	254	10.00	254	4.06	103	4.06	103
121245 L COMBO	121245 L COMBOGV	12.00	305	12.00	305	4.50	114	4.50	114
2245 L SIDE	--	2.50	64	2.50	64	1.97	50	1.97	50
3345 L SIDE	--	3.00	76	3.00	76	2.56	65	2.56	65
4445 L SIDE	--	4.00	102	4.00	102	2.75	70	2.75	70
6445 L SIDE	--	6.00	153	4.00	102	3.18	81	3.18	81
6645 L SIDE	--	6.00	153	6.00	153	3.18	81	3.18	81
8845 L SIDE	--	8.00	203	8.00	203	3.62	92	3.62	92
101045 L SIDE	--	10.00	254	10.00	254	4.06	103	4.06	103
121245 L SIDE	--	12.00	305	12.00	305	4.50	114	4.50	114

Tee

Catalog Number		A		B		E		F	
Painted	Galvanized	in.	mm	in.	mm	in.	mm	in.	mm
22 T	22 TGV	2.50	64	2.50	64	4.25	108	4.25	108
33 T	--	3.00	76	3.00	76	4.50	114	4.50	114
44 T	44 TGV	4.00	102	4.00	102	5.00	127	5.00	127
64 T	--	6.00	153	4.00	102	7.00	178	7.00	178
66 T	66 TGV	6.00	153	6.00	153	7.00	178	7.00	178
88 T	88 TGV	8.00	203	8.00	203	8.00	203	8.00	203
1010 T	1010 TGV	10.00	254	10.00	254	9.00	229	9.00	229
1212 T	1212 TGV	12.00	305	12.00	305	10.00	254	10.00	254

Cross

Catalog Number		A		B		E		F	
Painted	Galvanized	in.	mm	in.	mm	in.	mm	in.	mm
22 X	22 XGV	2.50	64	2.50	64	4.25	108	4.25	108
33 X	--	3.00	76	3.00	76	5.62	143	5.62	143
44 X	44 XGV	4.00	102	4.00	102	6.12	155	6.12	155
64 X	--	6.00	152	4.00	102	7.12	181	7.12	181
66 X	66 XGV	6.00	152	6.00	152	7.12	181	7.12	181
88 X	88 XGV	8.00	203	8.00	203	8.12	206	8.12	206
1010 X	1010 XGV	10.00	254	10.00	254	9.12	232	9.12	232
1212 X	1212 XGV	12.00	305	12.00	305	10.12	257	10.12	257

Notes: Dimensions are in inches. Millimeters shown are for reference only. Data subject to change without notice.