

INSTRUCTIONS  
Laser Distance  
Measurer

- SINGLE OR CONTINUOUS DISTANCE MEASUREMENT
- ADD OR SUBTRACT MEASUREMENTS
- AREA
- PERIMETER
- VOLUME
- DIRECT AND INDIRECT MEASUREMENT
- LCD DISPLAY
- BACKLIGHT
- AUDIBLE BEEP

ESPAÑOL: Ver en interior  
FRANÇAIS : Voir à l'intérieur



FEATURE DETAILS



NOTE: There are no user-serviceable parts inside.

DEVICE
1 Power on/Measurement button
2 Measurement options button
3 Continuous measurement button
4 Add/subtract measurements button
5 Reference point, Sound on/off button
6 Clear/Power Off button
7 Memory storage button
8 Backlight/Unit of measure button
9 Backlit LCD screen (see below)
10 Battery cover
11 Battery cover screw
12 Depth gauge stick (flips out)

OPERATING INSTRUCTIONS

**INSTALLING BATTERIES**  
Loosen screw (11) on battery cover (10) (do not remove screw from cover), extend the depth gauge stick (12), remove cover. Insert included batteries, replace cover, stow the depth gauge stick and tighten screw.

**POWER ON**  
A long press of the Power on/Measurement button (1) will power on the device and go to single distance measurement mode.

**POWER OFF**  
**Manual Power Off:** A long press of the Power Off button (6) will power off the device.  
**Automatic Power Off:** The device will automatically power off after 3 minutes of inactivity.

**SOUND CONTROL**  
A long press of the Sound On/Off button (5) will mute or unmute the speaker.

**BACKLIGHT**  
Quick-press the Backlight button (8) to turn backlight on and off. Backlight will automatically turn off after 20 seconds of inactivity.

**UNIT OF MEASURE**  
Long-press the Backlight/Units button (8) to toggle between "ft-in" (feet and inches), "in" (inches), "ft" (feet), and "m" (meters). Unit will power on with last unit of measure selected.

**ADDITION/SUBTRACTION**  
Take a measurement, press the Add/Subtract measurement button (4) (quick-press for addition "+" or long-press for subtraction "-"), then press the Power on/Measurement button (1) to take the second measurement. The second value will automatically be added to/subtracted from the first value in the displayed result.

**CANCEL/CLEAR**  
Quick-press Power Off button (6) at any time to cancel the last action or clear measured data.

**MEMORY STORAGE**  
Press the Memory Storage button (7) to view saved data. The last 20 measurements will be displayed, most recent first.

**REFERENCE POINT (Fig. 1)**  
Quick-press the Reference Point button (5) to toggle the measurement reference point between the top, bottom, and depth gauge stick of the tester. A beep will sound when the reference point is changed. NOTE: When the unit is powered on, the default reference point automatically resets to the bottom.

OPERATING INSTRUCTIONS

**VOLUME MEASUREMENT**  
1. Press the Measurement Options button (2) twice; the volume icon will appear on the display.  
2. Press the Power on/Measurement button (1) to take the first measurement (e.g. Length).  
3. Press the Power on/Measurement button (1) again to take the second measurement (e.g. Width).  
4. Press the Power on/Measurement button (1) again to take the third measurement (e.g. Height).  
5. The results of length, width and height will be displayed as volume.

**INDIRECT MEASUREMENT (PYTHAGORAS)**  
This device calculates indirect distance using the Pythagorean Theorem. NOTE: Target points should be in the same plane, and the second measurement should be taken perpendicular to the surface of the dimension being measured.

**Pythagoras - 2 points (Fig. 2):**  
1. Press the Measurement Options button (2) three times; the Pythagoras 2-Point icon will appear on the display.  
2. Press the Power on/Measurement button (1) to take the first measurement (e.g. Length).  
3. Press the Power on/Measurement button (1) again to take the second measurement (e.g. Width). The result will show in the display.

**Pythagoras - 3 points (Fig. 3):**  
1. Press the Measurement Options button (2) four times; the Pythagoras 3-Point icon will appear on the display.  
2. Press the Power on/Measurement button (1) to take the first measurement (e.g. first corner).  
3. Press the Power on/Measurement button (1) again to take the second measurement (center).  
4. Press the Power on/Measurement button (1) again to take the third measurement (e.g. second corner). The result will show in the display.

TROUBLESHOOTING

All errors are displayed as codes, as explained below:

Code	Cause	Corrective Measure
204	Calculation error	Repeat steps in manual
208	Component failure	Contact Klein Tools
220	Low battery	Replace batteries (2 x AAA)
252	Temperature too high	Use only in temperatures 32° to 104°F (0° to 40°C)
253	Temperature too low	Warm up device
255	Signal too weak / takes too long to register	Use target plate or change measurement angle
256	Signal too strong	Use target plate or change measurement angle
261	Measurement out of range	Measure within 65' (20 m)
500	Hardware error	Power unit on/off several times. If error persists, contact Klein Tools.

CLEANING

Be sure power is turned off and wipe with a clean, dry lint-free cloth. Do not use abrasive cleaners or solvents.

STORAGE

Remove the batteries when meter is not in use for a prolonged period of time. Do not expose to high temperatures or humidity. After a period of storage in extreme conditions exceeding the limits mentioned in the General Specifications section, allow the meter to return to normal operating conditions before using.

WARRANTY

www.kleintools.com/warranty

DISPOSAL / RECYCLE

Do not place equipment and its accessories in the trash. Items must be properly disposed of in accordance with local regulations. Please see www.epa.gov or www.ecycle.org for additional information.

CUSTOMER SERVICE

KLEIN TOOLS, INC.  
450 Bond Street, Lincolnshire, IL 60069 1-877-775-5346  
customerservice@kleintools.com www.kleintools.com

GENERAL SPECIFICATIONS

Klein Tools 93LDM65 Laser Distance Measurer easily calculates distance, area, perimeter and volume up to 65' (20 m) using direct and indirect measurements with an accuracy of +/- 1/16" (1.6 mm). It provides both imperial and metric readings and takes single, continuous (Max/Min) and cumulative measurements.

- Units: Feet / Inches / Meters
- Laser class: Class 2
- Laser Type: 635nm, < 1mW
- Range: 8' to 65 ft. (0.2 to 20 m)
- Accuracy: +/- 1/16" (1.6 mm)
- Memory / Storage: 20 readings or sets
- Auto-Off - Laser: 30 seconds
- Auto-Off - Device: 3 minutes
- Operating Temp: 32° to 104°F (0° to 40°C)
- Storage Temp: 14° to 140°F (-10° to 60°C)
- Dimensions: 4.5" x 2.0" x 1.4" (115 x 52 x 32 mm)
- Weight: 4.5 oz. (118 g)
- Battery Type: 2 x AAA
- Ingress Protection: IP54
- Drop Protection: 3.3 ft. (1 m)

NOTE: Measurement range and accuracy are based on typical conditions and may deteriorate under unfavorable conditions such as bright sunlight or poor reflectivity.

Specifications subject to change.

FEATURE DETAILS

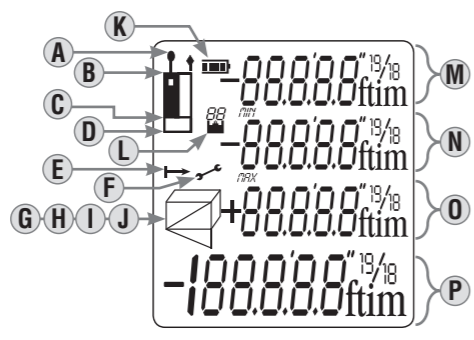

LCD DISPLAY
A Laser on
B Reference point (Top)
C Reference point (Bottom)
D Reference point (Depth gauge stick)
E Indicates unit is actively measuring
F Error message
G Area function icon
H Volume function icon
I Pythagoras 2-Point function icon
J Pythagoras 3-Point function icon
K Battery status
L Memory readings
M Value 1 / Min value
N Value 2 / Max value
O Value 3
P Summary Line / Latest Value / Calculation Result

OPERATING INSTRUCTIONS

**SINGLE DISTANCE MEASUREMENT**  
Press the Power on/Measurement button (1) to activate the laser. Press again to take a measurement. The result is displayed immediately.

**CONTINUOUS MEASUREMENT (MIN/MAX)**  
Press the Continuous Measurement button (3) to activate Continuous Measurement mode. The display will show the maximum (N) and minimum (M) distance values. The last measured value will display in the Summary Line (P). Pressing the Power on/Measurement (1) or Power Off button (6) will exit this mode.

**AREA MEASUREMENT**  
1. Press the Measurement Options button (2) once; the area icon will appear on the display.  
2. Press the Power on/Measurement button (1) to take the first measurement (e.g. Length).  
3. Press the Power on/Measurement button (1) again to take the second measurement (e.g. Width). The results of length, width and area will show in the display.



INSTRUCCIONES  
Medidor de  
distancia láser

- MEDICIÓN DE UNA SOLA DISTANCIA O VARIAS DISTANCIAS SEGUIDAS
- SUMA/RESTA DE MEDICIONES
- ÁREA
- PERÍMETRO
- VOLUMEN
- MEDICIÓN DIRECTA E INDIRECTA
- PANTALLA LCD
- RETROILUMINACIÓN
- INDICADOR SONORO

ESPAÑOL: Ver en interior  
FRANÇAIS : Voir à l'intérieur



DETALLES DE LAS CARACTERÍSTICAS



NOTA: El dispositivo no contiene en su interior piezas que el usuario pueda reparar.

DISPOSITIVO
1 Botón de encendido/medición
2 Botón de opciones de medición
3 Botón de medición de varias distancias seguidas
4 Botón de suma/resta de mediciones
5 Botón de punto de referencia y encendido/apagado del sonido
6 Botón CLR/OFF para borrar/apagar
7 Botón de almacenamiento en la memoria
8 Botón de retroiluminación/unidad de medida
9 Pantalla LCD retroiluminada (vea a continuación)
10 Cubierta del compartimento de la batería
11 Tornillo del compartimento de baterías
12 Varilla medidora de profundidad (se jala hacia afuera)

ESPECIFICACIONES GENERALES

El medidor de distancia láser Klein Tools 93LDM65 calcula fácilmente distancia, área, perímetro y volumen, hasta 65 pies (20 m) de distancia mediante mediciones directas e indirectas con una precisión de +/- 1/16" (1,6 mm). Proporciona valores en sistema imperial y sistema métrico; y es ideal para tomar mediciones individuales, continuas (Máx/Min) y acumulativas.

- Unidades: Pies/pulgadas/metros
- Clase de láser: Clase 2
- Tipo de láser: 635 nm < 1 mW
- Rango: de 8' a 65 pies (de 0.2 m a 20 m)
- Precisión: +/- 1/16" (1,6 mm)
- Memoria/almacenamiento: 20 lecturas o grupos
- Apagado automático - Láser: 30 segundos
- Apagado automático - Dispositivo: 3 minutos
- Temperatura de operación: 32 °F a 104 °F (0 °C a 40 °C)
- Temperatura de almacenamiento: 14 °F a 140 °F (-10 °C a 60 °C)
- Dimensiones: 4,5" x 2,0" x 1,4" (115 mm x 52 mm x 32 mm)
- Peso: 4,5 oz (118 g)
- Tipo de batería: 2 x AAA
- Protección contra el ingreso de objetos sólidos y líquidos: IP54
- Protección ante caídas: 3,3 pies (1 m)

NOTA: los valores de rango y precisión de las mediciones están basados en condiciones típicas; pueden verse afectados ante condiciones desfavorables como luz solar intensa o bajo grado de reflectancia.

Especificaciones sujetas a cambios.

DETALLES DE LAS CARACTERÍSTICAS

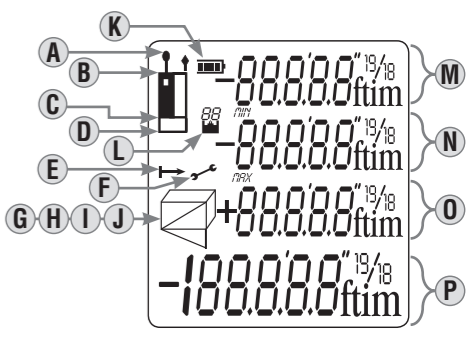

PANTALLA LCD
A Láser encendido
B Punto de referencia (parte superior)
C Punto de referencia (parte inferior)
D Punto de referencia (varilla medidora de profundidad)
E Indicación de que la unidad está realizando una medición
F Mensaje de error
G Icono de función de medición de área
H Icono de función de medición de volumen
I Icono de función de Pitágoras de 2 puntos
J Icono de función de Pitágoras de 3 puntos
K Estado de las baterías
L Lecturas de la memoria
M Valor 1/valor mín.
N Valor 2/valor máx.
O Valor 3
P Línea de resumen/último valor/resultados del cálculo

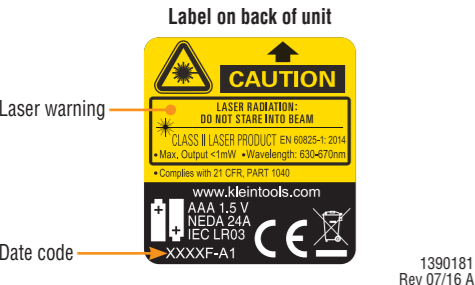

CONTINÚA DEL OTRO LADO



INSTRUCTIONS

Laser Distance Measurer

- SINGLE OR CONTINUOUS DISTANCE MEASUREMENT
- ADD OR SUBTRACT MEASUREMENTS
- AREA
- PERIMETER
- VOLUME
- DIRECT AND INDIRECT MEASUREMENT
- LCD DISPLAY
- BACKLIGHT
- AUDIBLE BEEP



ESPAÑOL: Ver en interior

FRANÇAIS : Voir à l'intérieur



GENERAL SPECIFICATIONS

Klein Tools 93LDM65 Laser Distance Measurer easily calculates distance, area, perimeter and volume up to 65' (20 m) using direct and indirect measurements with an accuracy of +/- 1/16" (1.6 mm). It provides both imperial and metric readings and takes single, continuous (Max/Min) and cumulative measurements.

- Units: Feet / Inches / Meters
- Laser class: Class 2
- Laser Type: 635nm, < 1mW
- Range: 8' to 65 ft. (0.2 to 20 m)
- Accuracy: +/- 1/16" (1.6 mm)
- Memory / Storage: 20 readings or sets
- Auto-Off - Laser: 30 seconds
- Auto-Off - Device: 3 minutes
- Operating Temp: 32° to 104°F (0° to 40°C)
- Storage Temp: 14° to 140°F (-10° to 60°C)
- Dimensions: 4.5" x 2.0" x 1.4" (115 x 52 x 32 mm)
- Weight: 4.5 oz. (118 g)
- Battery Type: 2 x AAA
- Ingress Protection: IP54
- Drop Protection: 3.3 ft. (1 m)

**NOTE:** Measurement range and accuracy are based on typical conditions and may deteriorate under unfavorable conditions such as bright sunlight or poor reflectivity.

Specifications subject to change.

Label on back of unit



Laser warning

Date code

1390181 Rev 07/16 A

FEATURE DETAILS



NOTE: There are no user-serviceable parts inside.

DEVICE
1 Power on/Measurement button
2 Measurement options button
3 Continuous measurement button
4 Add/subtract measurements button
5 Reference point, Sound on/off button
6 Clear/Power Off button
7 Memory storage button
8 Backlight/Unit of measure button
9 Backlit LCD screen (see below)
10 Battery cover
11 Battery cover screw
12 Depth gauge stick (flips out)

FEATURE DETAILS

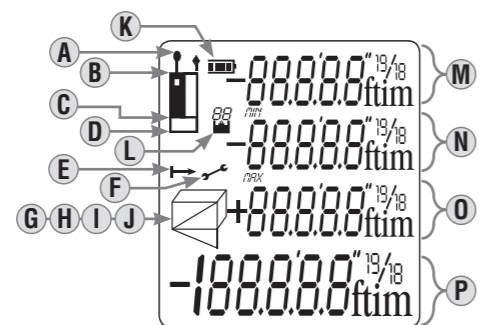

LCD DISPLAY
A Laser on
B Reference point (Top)
C Reference point (Bottom)
D Reference point (Depth gauge stick)
E Indicates unit is actively measuring
F Error message
G Area function icon
H Volume function icon
I Pythagoras 2-Point function icon
J Pythagoras 3-Point function icon
K Battery status
L Memory readings
M Value 1 / Min value
N Value 2 / Max value
O Value 3
P Summary Line / Latest Value / Calculation Result

OPERATING INSTRUCTIONS

INSTALLING BATTERIES

Loosen screw 11 on battery cover 10 (do not remove screw from cover), extend the depth gauge stick 12, remove cover. Insert included batteries, replace cover, stow the depth gauge stick and tighten screw.

POWER ON

A long press of the Power on/Measurement button 1 will power on the device and go to single distance measurement mode.

POWER OFF

**Manual Power Off:** A long press of the Power Off button 6 will power off the device.

**Automatic Power Off:** The device will automatically power off after 3 minutes of inactivity.

SOUND CONTROL

A long press of the Sound On/Off button 5 will mute or unmute the speaker.

BACKLIGHT

Quick-press the Backlight button 8 to turn backlight on and off. Backlight will automatically turn off after 20 seconds of inactivity.

UNIT OF MEASURE

Long-press the Backlight/Units button 8 to toggle between "ft-in" (feet and inches), "in" (inches), "ft" (feet), and "m" (meters). Unit will power on with last unit of measure selected.

ADDITION/SUBTRACTION

Take a measurement, press the Add/Subtract measurement button 4 (quick-press for addition "+" or long-press for subtraction "-"), then press the Power on/Measurement button 1 to take the second measurement. The second value will automatically be added to/subtracted from the first value in the displayed result.

CANCEL/CLEAR

Quick-press Power Off button 6 at any time to cancel the last action or clear measured data.

MEMORY STORAGE

Press the Memory Storage button 7 to view saved data. The last 20 measurements will be displayed, most recent first.

REFERENCE POINT (Fig. 1)

Quick-press the Reference Point button 5 to toggle the measurement reference point between the top, bottom, and depth gauge stick of the tester. A beep will sound when the reference point is changed. **NOTE:** When the unit is powered on, the default reference point automatically resets to the bottom.

OPERATING INSTRUCTIONS

VOLUME MEASUREMENT

1. Press the Measurement Options button 2 twice; the volume icon will appear on the display.
2. Press the Power on/Measurement button 1 to take the first measurement (e.g. Length).
3. Press the Power on/Measurement button 1 again to take the second measurement (e.g. Width).
4. Press the Power on/Measurement button 1 again to take the third measurement (e.g. Height).
5. The results of length, width and height will be displayed as volume.

INDIRECT MEASUREMENT (PYTHAGORAS)

This device calculates indirect distance using the Pythagorean Theorem. **NOTE:** Target points should be in the same plane, and the second measurement should be taken perpendicular to the surface of the dimension being measured.

Pythagoras - 2 points (Fig. 2):

1. Press the Measurement Options button 2 three times; the Pythagoras 2-Point icon will appear on the display.
2. Press the Power on/Measurement button 1 to take the first measurement (e.g. Length).
3. Press the Power on/Measurement button 1 again to take the second measurement (e.g. Width). The result will show in the display.

Pythagoras - 3 points (Fig. 3):

1. Press the Measurement Options button 2 four times; the Pythagoras 3-Point icon will appear on the display.
2. Press the Power on/Measurement button 1 to take the first measurement (e.g. first corner).
3. Press the Power on/Measurement button 1 again to take the second measurement (center).
4. Press the Power on/Measurement button 1 again to take the third measurement (e.g. second corner). The result will show in the display.

TROUBLESHOOTING

All errors are displayed as codes, as explained below:

Code	Cause	Corrective Measure
204	Calculation error	Repeat steps in manual
208	Component failure	Contact Klein Tools
220	Low battery	Replace batteries (2 x AAA)
252	Temperature too high	Use only in temperatures 32° to 104°F (0° to 40°C)
253	Temperature too low	Warm up device
255	Signal too weak / takes too long to register	Use target plate or change measurement angle
256	Signal too strong	Use target plate or change measurement angle
261	Measurement out of range	Measure within 65' (20 m)
500	Hardware error	Power unit on/off several times. If error persists, contact Klein Tools.

CLEANING

Be sure power is turned off and wipe with a clean, dry lint-free cloth. **Do not use abrasive cleaners or solvents.**

STORAGE

Remove the batteries when meter is not in use for a prolonged period of time. Do not expose to high temperatures or humidity. After a period of storage in extreme conditions exceeding the limits mentioned in the General Specifications section, allow the meter to return to normal operating conditions before using.

WARRANTY

www.kleintools.com/warranty

DISPOSAL / RECYCLE

Do not place equipment and its accessories in the trash. Items must be properly disposed of in accordance with local regulations. Please see [www.epa.gov](http://www.epa.gov) or [www.erecycle.org](http://www.erecycle.org) for additional information.

CUSTOMER SERVICE

KLEIN TOOLS, INC.  
450 Bond Street, Lincolnshire, IL 60069 1-877-775-5346  
customerservice@kleintools.com www.kleintools.com

INSTRUCCIONES

Medidor de distancia láser

- MEDICIÓN DE UNA SOLA DISTANCIA O VARIAS DISTANCIAS SEGUIDAS
- SUMA/RESTA DE MEDICIONES
- ÁREA
- PERÍMETRO
- VOLUMEN
- MEDICIÓN DIRECTA E INDIRECTA
- PANTALLA LCD
- RETROILUMINACIÓN
- INDICADOR SONORO



DETALLES DE LAS CARACTERÍSTICAS



NOTA: El dispositivo no contiene en su interior piezas que el usuario pueda reparar.

DISPOSITIVO
1 Botón de encendido/medición
2 Botón de opciones de medición
3 Botón de medición de varias distancias seguidas
4 Botón de suma/resta de mediciones
5 Botón de punto de referencia y encendido/apagado del sonido
6 Botón CLR/OFF para borrar/apagar
7 Botón de almacenamiento en la memoria
8 Botón de retroiluminación/unidad de medida
9 Pantalla LCD retroiluminada (vea a continuación)
10 Cubierta del compartimento de la batería
11 Tornillo del compartimento de baterías
12 Varilla medidora de profundidad (se jala hacia afuera)

DETALLES DE LAS CARACTERÍSTICAS

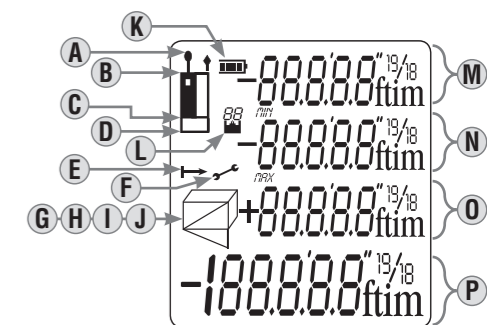

PANTALLA LCD
A Láser encendido
B Punto de referencia (parte superior)
C Punto de referencia (parte inferior)
D Punto de referencia (varilla medidora de profundidad)
E Indicación de que la unidad está realizando una medición
F Mensaje de error
G Icono de función de medición de área
H Icono de función de medición de volumen
I Icono de función de Pitágoras de 2 puntos
J Icono de función de Pitágoras de 3 puntos
K Estado de las baterías
L Lecturas de la memoria
M Valor 1/valor mín.
N Valor 2/valor máx.
O Valor 3
P Línea de resumen/último valor/resultado del cálculo

ESPECIFICACIONES GENERALES

El medidor de distancia láser Klein Tools 93LDM65 calcula fácilmente distancia, área, perímetro y volumen, hasta 65 pies (20 m) de distancia mediante mediciones directas e indirectas con una precisión de +/- 1/16" (1.6 mm). Proporciona valores en sistema imperial y sistema métrico; y es ideal para tomar mediciones individuales, continuas (Máx/Min) y acumulativas.

- Unidades: Pies/pulgadas/metros
- Clase de láser: Clase 2
- Tipo de láser: 635 nm < 1 mW
- Rango: de 8' a 65 pies (de 0.2 m a 20 m)
- Precisión: +/- 1/16" (1,6 mm)
- Memoria/almacenamiento: 20 lecturas o grupos
- Apagado automático - Láser: 30 segundos
- Apagado automático - Dispositivo: 3 minutos
- Temperatura de operación: 32 °F a 104 °F (0 °C a 40 °C)
- Temperatura de almacenamiento: 14 °F a 140 °F (-10 °C a 60 °C)
- Dimensiones: 4,5" x 2,0" x 1,4" (115 mm x 52 mm x 32 mm)
- Peso: 4,5 oz (118 g)
- Tipo de batería: 2 x AAA
- Protección contra el ingreso de objetos sólidos y líquidos: IP54
- Protección ante caídas: 3,3 pies (1 m)

**NOTA:** los valores de rango y precisión de las mediciones están basados en condiciones típicas; pueden verse afectados ante condiciones desfavorables como luz solar intensa o bajo grado de reflectancia.

Especificaciones sujetas a cambios.

Etiqueta de la parte posterior de la unidad



Advertencia referida al láser

Código de fecha

