

THE WALL OF ORANGE™

BUILT FOR WHAT MATTERS



BUSHINGS REDEFINED.

MIGHTY-RITE® SPLIT BUSHINGS
DO MORE THAN JUST PROTECT CONDUCTORS.

STEEL



1/2 TO 6-INCH TRADE SIZES

NONMETALLIC



1 TO 4-INCH TRADE SIZES

ZINC



3/4 TO 4-INCH TRADE SIZES

NO MORE BURNING THROUGH BUSHINGS
OR FIGHTING WITH PULLERS.

See the Difference a bushing can make on your next job.

 **BRIDGEPORT**
BPTFITTINGS.COM



SEE THE DIFFERENCE
ORANGE MAKES™
BPTFITTINGS.COM/SPLIT

MIGHTY-RITE® SPLIT GROUNDING BUSHINGS

THE RIGHT SOLUTION BEFORE OR AFTER YOU PULL WIRE

Install MIGHTY-RITE Split Grounding Bushings before or after you pull wire and make connections. Its hinged design and adjustable grounding lug deliver installation flexibility on every job. So you can move on to the next job faster. It's another contractor innovation from Bridgeport.

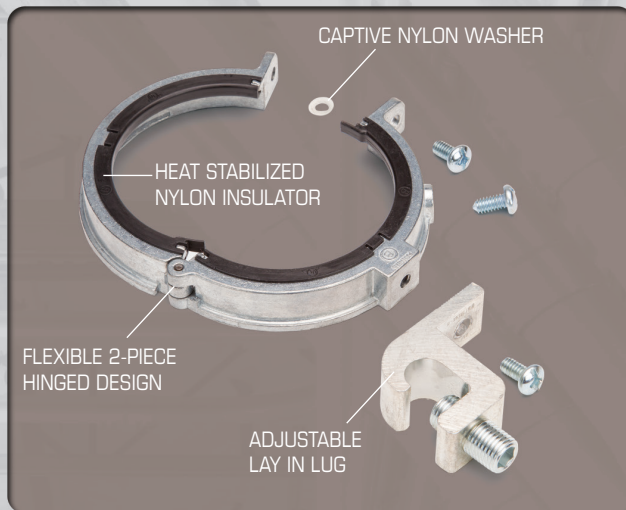

- CAN BE INSTALLED BEFORE WIRE PULL, OR AFTER - WITHOUT EXPENSIVE REWORK
- ADJUSTABLE GROUNDING LUG ACCEPTS WIRE EASIER
- PULLING LARGER CONDUCTOR WIRE IS EASIER WHEN YOU CAN INSTALL GROUNDING BUSHINGS AFTER THE PULL
- LOW PROFILE
- HINGED DESIGN ADJUSTS AND ALIGNS EASIER - EVEN IN TIGHT SPOTS
- cULus LISTED
- AVAILABLE IN ZINC AND STEEL
- 150°C CAPTIVE NYLON INSULATOR



Mighty-Rite® Split Grounding Bushings

Mighty-Rite's hinged design and adjustable grounding lug deliver installation flexibility on every job. Zinc Die Cast versions provided with stainless steel hardware. Perfect for Solar Applications! Patented.

cULus File No. E20412

Zinc Die Cast / Nylon Insulator - 150°C



Catalog Number	Grounding Lug Wire Capacity		Trade Size	Unit Qty.	Std. Qty.
	Min. Solid Strand	Max.			
SGB-382CL	14 to 4		3/4"	25	250
SGB-383CL	14 to 4		1"	25	250
SGB-38414	14 to 4		1 1/4"	20	200
SGB-384CL	14 to 1/0		1 1/4"	20	200
SGB-38514	14 to 4		1 1/2"	20	200
SGB-385CL	14 to 1/0		1 1/2"	20	200
SGB-38614	14 to 4		2"	10	100
SGB-386CL	14 to 1/0		2"	10	100
SGB-38740	6 to 250 MCM		2 1/2"	---	25
SGB-387CL	14 to 1/0		2 1/2"	---	25
SGB-38840	6 to 250 MCM		3"	---	25
SGB-388CL	14 to 1/0		3"	---	25
SGB-38940	6 to 250 MCM		3 1/2"	---	25
SGB-389CL	6 to 3/0		3 1/2"	---	25
SGB-39040	6 to 250 MCM		4"	---	20
SGB-390CL	6 to 3/0		4"	---	20

Steel / Nylon Insulator - 150°C

Catalog Number	Grounding Lug Wire Capacity		Trade Size	Unit Qty.	Std. Qty.
	Min. Solid Strand	Max.			
SGBS-381CL	14 to 4		1/2"	25	100
SGBS-382CL	14 to 4		3/4"	25	250
SGBS-383CL	14 to 4		1"	25	250
SGBS-38414	14 to 4		1 1/4"	20	200
SGBS-384CL	14 to 1/0		1 1/4"	20	200
SGBS-38514	14 to 4		1 1/2"	20	200
SGBS-385CL	14 to 1/0		1 1/2"	20	200
SGBS-38614	14 to 4		2"	10	100
SGBS-386CL	14 to 1/0		2"	10	100
SGBS-38740	6 to 250 MCM		2 1/2"	---	25
SGBS-387CL	14 to 1/0		2 1/2"	---	25
SGBS-38840	6 to 250 MCM		3"	---	25
SGBS-388CL	14 to 1/0		3"	---	25
SGBS-38940	6 to 250 MCM		3 1/2"	---	25
SGBS-389CL	6 to 3/0		3 1/2"	---	25
SGBS-39040	6 to 250 MCM		4"	---	20
SGBS-390CL	6 to 3/0		4"	---	20
SGBS-39050	350 to 500 MCM		4"	---	20
SGBS-39150	350 to 500 MCM		5"	---	20
SGBS-39250	350 to 500 MCM		6"	---	20

FOR MORE INFORMATION, VISIT: WWW.BPTFITTINGS.COM

NO BUSHING? NO WORRIES.

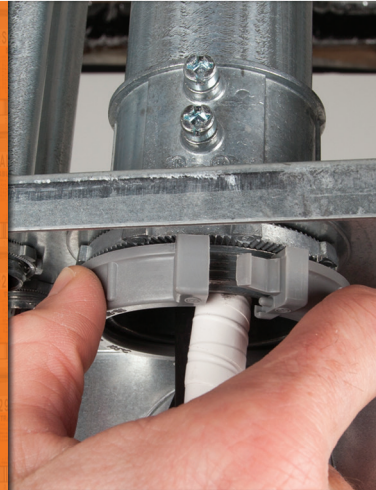

MIGHTY-RITE® NONMETALLIC SPLIT BUSHINGS

Needed to install an insulated bushing? Mighty-Rite's hinged design solves your problem. Simply snap-on before or after inspection. It's another contractor innovation from Bridgeport.

Patented and Other Patents Pending.

- CAN BE INSTALLED BEFORE WIRE PULL, OR AFTER – WITHOUT EXPENSIVE REWORK
- PULLING LARGER CONDUCTOR WIRE IS EASIER WHEN YOU CAN INSTALL BUSHINGS AFTER THE PULL
- HINGED DESIGN ADJUSTS AND ALIGNS EASIER – EVEN IN TIGHT SPOTS
- UNIQUE, SELF-ALIGNING LATCHING MECHANISM ALLOWS ONE HAND INSTALLATION
- cULus LISTED
- AVAILABLE IN 1- TO 4-INCH TRADE SIZES
- RATED 105°C

Distributed by:



 **BRIDGEPORT**
BPTFITTINGS.COM

Bridgeport Fittings, Inc.
705 Lordship Blvd.
Stratford, CT 06615-7313

Voice: 203.377.5944
Fax: 203.381.3488
E-mail: sales@bptfittings.com

CONNECT
ONLINE



Printed in the U.S.A.
© 2017 Bridgeport Fittings, Inc. All rights reserved.



3/17 XXXX BP-825

BUSHINGS ENGINEERED WITH THE BRIDGEPORT DIFFERENCE



Insulated Grounding Bushings

Used with locknut to terminate service conduit to cabinet. Aluminum alloy lug provided for bonding jumper to neutral busbar. Plastic liner prevents damage to wire insulation.

UL File No. E20412

Malleable Iron / Nylon Insulator - 150°C

Catalog Number	Grounding Lug Wire Capacity		Trade Size	Unit Qty.	Std. Qty.
	Min. Solid Strand	Max.			
381	14 to 4		1/2"	50	500
382	14 to 4		3/4"	50	500
383	14 to 4		1"	25	250
384	14 to 1/0		1 1/4"	20	200
384-14	14 to 4		1 1/4"	20	200
385	14 to 1/0		1 1/2"	20	200
385-14	14 to 4		1 1/2"	20	200
386	14 to 1/0		2"	10	100
386-14	14 to 4		2"	10	100
387	14 to 1/0		2 1/2"	---	25
387-40	6 to 250 MCM		2 1/2"	---	25
388	14 to 1/0		3"	---	25
388-40	6 to 250 MCM		3"	---	25
389	14 to 1/0		3 1/2"	---	25
389-40	6 to 250 MCM		3 1/2"	---	25
390	14 to 1/0		4"	---	20
390-40	6 to 250 MCM		4"	---	20
391	6 to 250 MCM		5"	---	5
392	6 to 250 MCM		6"	---	5

Zinc Die Cast / Nylon Insulator - 150°C

Catalog Number	Grounding Lug Wire Capacity		Trade Size	Unit Qty.	Std. Qty.
	Min. Solid Strand	Max.			
381-DC	14 to 4		1/2"	50	500
382-DC	14 to 4		3/4"	50	500
383-DC	14 to 4		1"	25	250
384-DC	14 to 1/0		1 1/4"	20	200
384-DC14	14 to 4		1 1/4"	20	200
385-DC	14 to 1/0		1 1/2"	20	200
385-DC14	14 to 4		1 1/2"	20	200
386-DC	14 to 1/0		2"	10	100
386-DC14	14 to 4		2"	10	100
387-DC	14 to 1/0		2 1/2"	---	25
387-DC40	6 to 250 MCM		2 1/2"	---	25
388-DC	14 to 1/0		3"	---	25
388-DC40	6 to 250 MCM		3"	---	25
389-DC	14 to 1/0		3 1/2"	---	25
389-DC40	6 to 250 MCM		3 1/2"	---	25
390-DC	14 to 1/0		4"	---	20
390-DC40	6 to 250 MCM		4"	---	20



Mighty-Rite® Nonmetallic Split Bushings

Patented split design allows for installation after conductors have been pulled. Used with a locknut to terminate threaded rigid and IMC to a box or enclosure. Used with a connector to prevent damage to wire insulation. Rated 105°C.

UL File No. E9391

Nonmetallic Split Bushing

Catalog Number	Trade Size	Unit Qty.	Std. Qty.
SB-383NM	1"	25	250
SB-384NM	1 1/4"	20	200
SB-385NM	1 1/2"	20	200
SB-386NM	2"	10	100
SB-387NM	2 1/2"	---	25
SB-388NM	3"	---	25
SB-389NM	3 1/2"	---	25
SB-390NM	4"	---	20

Threadless Grounding Bushings

Used with a locknut to terminate threadless rigid conduit or IMC to a cabinet. Aluminum alloy lug provided for bonding jumper to neutral busbar. Plastic liner prevents damage to wire insulation.

UL File No. E20412



Malleable Iron / Aluminum Alloy Lug

Catalog Number	Grounding Lug Wire Capacity		Trade Size	Unit Qty.	Std. Qty.
	Min. Solid Strand	Max.			
TL-381	14 to 4		1/2"	50	500
TL-382	14 to 4		3/4"	50	500
TL-383	14 to 4		1"	25	250
TL-384	8 to 1/0		1 1/4"	20	200
TL-38414	14 to 4		1 1/4"	20	200
TL-385	8 to 1/0		1 1/2"	20	200
TL-38514	14 to 4		1 1/2"	20	200
TL-386	8 to 1/0		2"	10	100
TL-38614	14 to 4		2"	10	100
TL-387	8 to 1/0		2 1/2"	---	25
TL-38740	6 to 250 MCM		2 1/2"	---	25
TL-388	8 to 1/0		3"	---	25
TL-38840	6 to 250 MCM		3"	---	25
TL-389	6 to 3/0		3 1/2"	---	25
TL-38940	6 to 250 MCM		3 1/2"	---	25
TL-390	6 to 3/0		4"	---	20
TL-39040	6 to 250 MCM		4"	---	20



Bushings

Used with locknut to protect conductors inside threaded rigid or IMC conduit entering a box. Rounded surface of bushing prevents damage to wire insulation.

UL File No. E9391: 321 thru 332

UL File No. E11259: 321-B thru 330-B

SF File No. LR39354

Polypropylene - 105°C

Catalog Number	Trade Size	Unit Qty.	Std. Qty.
321	1/2"	100	1000
322	3/4"	100	1000
323	1"	50	500
324	1 1/4"	---	100
325	1 1/2"	---	100
326	2"	---	50
327	2 1/2"	---	25
328	3"	---	25
329	3 1/2"	---	25
330	4"	---	20
331	5"	---	5
332	6"	---	5

Nylon - 150°C

Catalog Number	Trade Size	Unit Qty.	Std. Qty.
321-B	1/2"	100	1000
322-B	3/4"	100	1000
323-B	1"	50	500
324-B	1 1/4"	---	100
325-B	1 1/2"	---	100
326-B	2"	---	50
327-B	2 1/2"	---	25
328-B	3"	---	25
329-B	3 1/2"	---	25
330-B	4"	---	20



Insulated Bushings

Used with locknut to protect conductors inside threaded rigid or IMC conduit entering a box. Plastic liner prevents damage to wire insulation. All products rated 150°C except catalog numbers 371 and 372 which are rated 105°C.

UL File No. E9391

Malleable Iron / Nylon Insulator

Catalog Number	Trade Size	Unit Qty.	Std. Qty.
361	1/2"	100	1000
362	3/4"	100	1000
363	1"	50	500
364	1 1/4"	10	100
365	1 1/2"	10	100
366	2"	10	100
367	2 1/2"	2	10
368	3"	2	10
369	3 1/2"	---	5
370	4"	---	5
371	5"	---	5
372	6"	---	5

Zinc Die Cast / Nylon Insulator

Catalog Number	Trade Size	Unit Qty.	Std. Qty.
361-DC	1/2"	100	1000
362-DC	3/4"	100	1000
363-DC	1"	50	500
364-DC	1 1/4"	10	100
365-DC	1 1/2"	10	100
366-DC	2"	10	100
367-DC	2 1/2"	2	10
368-DC	3"	2	10
369-DC	3 1/2"	---	5
370-DC	4"	---	5



Pull Caps

Used for capping EMT, rigid and most bushings.
 File No. LR39354

Polypropylene

Catalog Number	Trade Size	Unit Qty.	Std. Qty.
341	1/2"	100	1000
342	3/4"	100	1000
343	1"	100	1000
344	1 1/4"	50	250
345	1 1/2"	25	100
346	2"	25	100



Stud Bushings

Protects wire insulation from abrasion in metal studs. Bushing allows smooth wire pulling.
 Used for all pre-punched shaped holes.

File No. E11259

Polypropylene

Catalog Number	Hole Dia.	Unit Qty.	Std. Qty.
9882	---	50	500

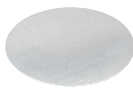
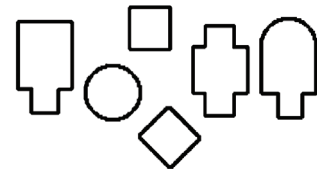

Bushing Pennies

Used inside bushing to prevent foreign matter from entering conduit.

Galvanized Steel

Catalog Number	Trade Size	Unit Qty.	Std. Qty.
1661	1/2"	500	1000
1662	3/4"	250	500
1663	1"	100	200
1664	1 1/4"	50	100
1665	1 1/2"	50	100
1666	2"	50	100
1667	2 1/2"	50	100
1668	3"	50	100
1669	3 1/2"	25	100
1670	4"	25	100
1671	5"	25	100



Insulating Bushing

EMT bushing insulates telephone, computer, video and other low voltage wiring from sharp edges of EMT. Complies with NEC Article 300-15(c).

Polyethylene - 90°C

Catalog Number	Trade Size	Unit Qty.	Std. Qty.
TWB-51	1/2"	100	1000
TWB-52	3/4"	50	500
TWB-53	1"	25	250
TWB-54	1 1/4"	25	250
TWB-55	1 1/2"	---	100
TWB-56	2"	---	50
TWB-57	2 1/2"	---	25
TWB-58	3"	---	25
TWB-59	3 1/2"	---	25
TWB-60	4"	---	25



Knockout Insulating Bushings

Converts metallic box rough edged holes to smooth insulated holes for protection of electrical, voice, data and video cables.

File No. LR24719

File No. E240912 (9791 thru 9796)

Nylon - 105°C

Catalog Number	K.O.	K.O. Dia.	Unit Qty.	Std. Qty.
9791	1/2"	.875"	100	1000
9792	3/4"	1.109"	100	1000
9793	1"	1.375"	50	500
9794	1 1/4"	1.734"	50	500
9795	1 1/2"	1.984"	25	250
9796	2"	2.469"	20	100
9797	2 1/2"	2.969"	20	100

THE WALL OF ORANGE™

BUILT FOR WHAT MATTERS



BUSHINGS REDEFINED.

MIGHTY-RITE® SPLIT BUSHINGS
DO MORE THAN JUST PROTECT CONDUCTORS.

STEEL



1/2 TO 6-INCH TRADE SIZES

NONMETALLIC



1 TO 4-INCH TRADE SIZES

ZINC



3/4 TO 4-INCH TRADE SIZES

NO MORE BURNING THROUGH BUSHINGS
OR FIGHTING WITH PULLERS.

See the Difference a bushing can make on your next job.

 **BRIDGEPORT**
BPTFITTINGS.COM



SEE THE DIFFERENCE
ORANGE MAKES™
BPTFITTINGS.COM/SPLIT

MIGHTY-RITE® SPLIT GROUNDING BUSHINGS

THE RIGHT SOLUTION BEFORE OR AFTER YOU PULL WIRE

Install MIGHTY-RITE Split Grounding Bushings before or after you pull wire and make connections. Its hinged design and adjustable grounding lug deliver installation flexibility on every job. So you can move on to the next job faster. It's another contractor innovation from Bridgeport.

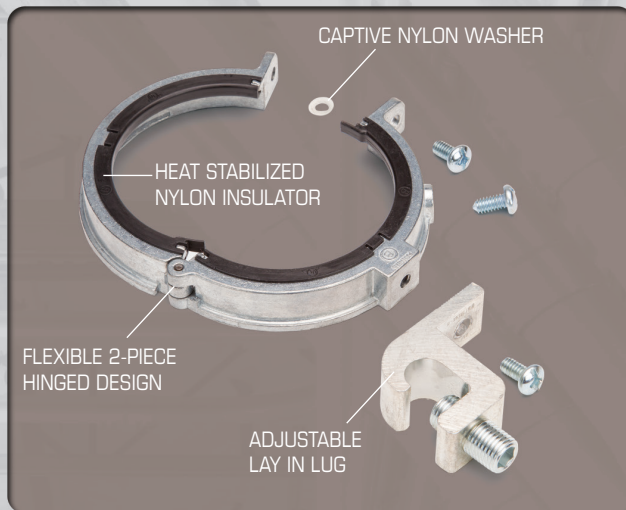

- CAN BE INSTALLED BEFORE WIRE PULL, OR AFTER - WITHOUT EXPENSIVE REWORK
- ADJUSTABLE GROUNDING LUG ACCEPTS WIRE EASIER
- PULLING LARGER CONDUCTOR WIRE IS EASIER WHEN YOU CAN INSTALL GROUNDING BUSHINGS AFTER THE PULL
- LOW PROFILE
- HINGED DESIGN ADJUSTS AND ALIGNS EASIER - EVEN IN TIGHT SPOTS
- cULus LISTED
- AVAILABLE IN ZINC AND STEEL
- 150°C CAPTIVE NYLON INSULATOR



Mighty-Rite® Split Grounding Bushings

Mighty-Rite's hinged design and adjustable grounding lug deliver installation flexibility on every job. Zinc Die Cast versions provided with stainless steel hardware. Perfect for Solar Applications! Patented.

cULus File No. E20412

Zinc Die Cast / Nylon Insulator - 150°C



Catalog Number	Grounding Lug Wire Capacity		Trade Size	Unit Qty.	Std. Qty.
	Min. Solid Strand	Max.			
SGB-382CL	14 to 4		3/4"	25	250
SGB-383CL	14 to 4		1"	25	250
SGB-38414	14 to 4		1 1/4"	20	200
SGB-384CL	14 to 1/0		1 1/4"	20	200
SGB-38514	14 to 4		1 1/2"	20	200
SGB-385CL	14 to 1/0		1 1/2"	20	200
SGB-38614	14 to 4		2"	10	100
SGB-386CL	14 to 1/0		2"	10	100
SGB-38740	6 to 250 MCM		2 1/2"	---	25
SGB-387CL	14 to 1/0		2 1/2"	---	25
SGB-38840	6 to 250 MCM		3"	---	25
SGB-388CL	14 to 1/0		3"	---	25
SGB-38940	6 to 250 MCM		3 1/2"	---	25
SGB-389CL	6 to 3/0		3 1/2"	---	25
SGB-39040	6 to 250 MCM		4"	---	20
SGB-390CL	6 to 3/0		4"	---	20

Steel / Nylon Insulator - 150°C

Catalog Number	Grounding Lug Wire Capacity		Trade Size	Unit Qty.	Std. Qty.
	Min. Solid Strand	Max.			
SGBS-381CL	14 to 4		1/2"	25	100
SGBS-382CL	14 to 4		3/4"	25	250
SGBS-383CL	14 to 4		1"	25	250
SGBS-38414	14 to 4		1 1/4"	20	200
SGBS-384CL	14 to 1/0		1 1/4"	20	200
SGBS-38514	14 to 4		1 1/2"	20	200
SGBS-385CL	14 to 1/0		1 1/2"	20	200
SGBS-38614	14 to 4		2"	10	100
SGBS-386CL	14 to 1/0		2"	10	100
SGBS-38740	6 to 250 MCM		2 1/2"	---	25
SGBS-387CL	14 to 1/0		2 1/2"	---	25
SGBS-38840	6 to 250 MCM		3"	---	25
SGBS-388CL	14 to 1/0		3"	---	25
SGBS-38940	6 to 250 MCM		3 1/2"	---	25
SGBS-389CL	6 to 3/0		3 1/2"	---	25
SGBS-39040	6 to 250 MCM		4"	---	20
SGBS-390CL	6 to 3/0		4"	---	20
SGBS-39050	350 to 500 MCM		4"	---	20
SGBS-39150	350 to 500 MCM		5"	---	20
SGBS-39250	350 to 500 MCM		6"	---	20

FOR MORE INFORMATION, VISIT: WWW.BPTFITTINGS.COM

NO BUSHING? NO WORRIES.

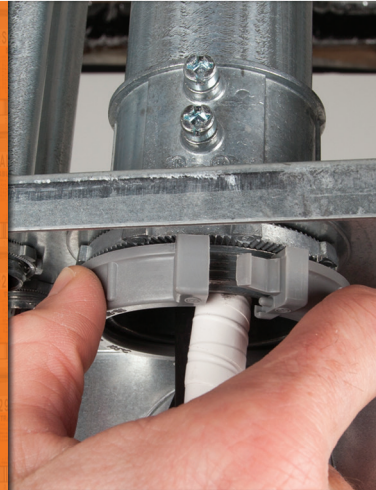

MIGHTY-RITE® NONMETALLIC SPLIT BUSHINGS

Needed to install an insulated bushing? Mighty-Rite's hinged design solves your problem. Simply snap-on before or after inspection. It's another contractor innovation from Bridgeport.

Patented and Other Patents Pending.

- CAN BE INSTALLED BEFORE WIRE PULL, OR AFTER – WITHOUT EXPENSIVE REWORK
- PULLING LARGER CONDUCTOR WIRE IS EASIER WHEN YOU CAN INSTALL BUSHINGS AFTER THE PULL
- HINGED DESIGN ADJUSTS AND ALIGNS EASIER – EVEN IN TIGHT SPOTS
- UNIQUE, SELF-ALIGNING LATCHING MECHANISM ALLOWS ONE HAND INSTALLATION
- cULus LISTED
- AVAILABLE IN 1- TO 4-INCH TRADE SIZES
- RATED 105°C

Distributed by:



 **BRIDGEPORT**
BPTFITTINGS.COM

Bridgeport Fittings, Inc.
705 Lordship Blvd.
Stratford, CT 06615-7313

Voice: 203.377.5944
Fax: 203.381.3488
E-mail: sales@bptfittings.com

CONNECT
ONLINE



Printed in the U.S.A.
© 2017 Bridgeport Fittings, Inc. All rights reserved.

3/17 XXXX BP-825

BUSHINGS ENGINEERED WITH THE BRIDGEPORT DIFFERENCE



Insulated Grounding Bushings

Used with locknut to terminate service conduit to cabinet. Aluminum alloy lug provided for bonding jumper to neutral busbar. Plastic liner prevents damage to wire insulation.

UL File No. E20412

Malleable Iron / Nylon Insulator - 150°C

Catalog Number	Grounding Lug Wire Capacity		Trade Size	Unit Qty.	Std. Qty.
	Min. Solid Strand	Max.			
381	14 to 4		1/2"	50	500
382	14 to 4		3/4"	50	500
383	14 to 4		1"	25	250
384	14 to 1/0		1 1/4"	20	200
384-14	14 to 4		1 1/4"	20	200
385	14 to 1/0		1 1/2"	20	200
385-14	14 to 4		1 1/2"	20	200
386	14 to 1/0		2"	10	100
386-14	14 to 4		2"	10	100
387	14 to 1/0		2 1/2"	---	25
387-40	6 to 250 MCM		2 1/2"	---	25
388	14 to 1/0		3"	---	25
388-40	6 to 250 MCM		3"	---	25
389	14 to 1/0		3 1/2"	---	25
389-40	6 to 250 MCM		3 1/2"	---	25
390	14 to 1/0		4"	---	20
390-40	6 to 250 MCM		4"	---	20
391	6 to 250 MCM		5"	---	5
392	6 to 250 MCM		6"	---	5

Zinc Die Cast / Nylon Insulator - 150°C

Catalog Number	Grounding Lug Wire Capacity		Trade Size	Unit Qty.	Std. Qty.
	Min. Solid Strand	Max.			
381-DC	14 to 4		1/2"	50	500
382-DC	14 to 4		3/4"	50	500
383-DC	14 to 4		1"	25	250
384-DC	14 to 1/0		1 1/4"	20	200
384-DC14	14 to 4		1 1/4"	20	200
385-DC	14 to 1/0		1 1/2"	20	200
385-DC14	14 to 4		1 1/2"	20	200
386-DC	14 to 1/0		2"	10	100
386-DC14	14 to 4		2"	10	100
387-DC	14 to 1/0		2 1/2"	---	25
387-DC40	6 to 250 MCM		2 1/2"	---	25
388-DC	14 to 1/0		3"	---	25
388-DC40	6 to 250 MCM		3"	---	25
389-DC	14 to 1/0		3 1/2"	---	25
389-DC40	6 to 250 MCM		3 1/2"	---	25
390-DC	14 to 1/0		4"	---	20
390-DC40	6 to 250 MCM		4"	---	20



Mighty-Rite® Nonmetallic Split Bushings

Patented split design allows for installation after conductors have been pulled. Used with a locknut to terminate threaded rigid and IMC to a box or enclosure. Used with a connector to prevent damage to wire insulation. Rated 105°C.

UL File No. E9391

Nonmetallic Split Bushing

Catalog Number	Trade Size	Unit Qty.	Std. Qty.
SB-383NM	1"	25	250
SB-384NM	1 1/4"	20	200
SB-385NM	1 1/2"	20	200
SB-386NM	2"	10	100
SB-387NM	2 1/2"	---	25
SB-388NM	3"	---	25
SB-389NM	3 1/2"	---	25
SB-390NM	4"	---	20

Threadless Grounding Bushings

Used with a locknut to terminate threadless rigid conduit or IMC to a cabinet. Aluminum alloy lug provided for bonding jumper to neutral busbar. Plastic liner prevents damage to wire insulation.

UL File No. E20412



Malleable Iron / Aluminum Alloy Lug

Catalog Number	Grounding Lug Wire Capacity		Trade Size	Unit Qty.	Std. Qty.
	Min. Solid Strand	Max.			
TL-381	14 to 4		1/2"	50	500
TL-382	14 to 4		3/4"	50	500
TL-383	14 to 4		1"	25	250
TL-384	8 to 1/0		1 1/4"	20	200
TL-38414	14 to 4		1 1/4"	20	200
TL-385	8 to 1/0		1 1/2"	20	200
TL-38514	14 to 4		1 1/2"	20	200
TL-386	8 to 1/0		2"	10	100
TL-38614	14 to 4		2"	10	100
TL-387	8 to 1/0		2 1/2"	---	25
TL-38740	6 to 250 MCM		2 1/2"	---	25
TL-388	8 to 1/0		3"	---	25
TL-38840	6 to 250 MCM		3"	---	25
TL-389	6 to 3/0		3 1/2"	---	25
TL-38940	6 to 250 MCM		3 1/2"	---	25
TL-390	6 to 3/0		4"	---	20
TL-39040	6 to 250 MCM		4"	---	20



Bushings

Used with locknut to protect conductors inside threaded rigid or IMC conduit entering a box. Rounded surface of bushing prevents damage to wire insulation.

UL File No. E9391: 321 thru 332

UL File No. E11259: 321-B thru 330-B

SF File No. LR39354

Polypropylene - 105°C

Catalog Number	Trade Size	Unit Qty.	Std. Qty.
321	1/2"	100	1000
322	3/4"	100	1000
323	1"	50	500
324	1 1/4"	---	100
325	1 1/2"	---	100
326	2"	---	50
327	2 1/2"	---	25
328	3"	---	25
329	3 1/2"	---	25
330	4"	---	20
331	5"	---	5
332	6"	---	5

Nylon - 150°C

Catalog Number	Trade Size	Unit Qty.	Std. Qty.
321-B	1/2"	100	1000
322-B	3/4"	100	1000
323-B	1"	50	500
324-B	1 1/4"	---	100
325-B	1 1/2"	---	100
326-B	2"	---	50
327-B	2 1/2"	---	25
328-B	3"	---	25
329-B	3 1/2"	---	25
330-B	4"	---	20



Insulated Bushings

Used with locknut to protect conductors inside threaded rigid or IMC conduit entering a box. Plastic liner prevents damage to wire insulation. All products rated 150°C except catalog numbers 371 and 372 which are rated 105°C.

UL File No. E9391

Malleable Iron / Nylon Insulator

Catalog Number	Trade Size	Unit Qty.	Std. Qty.
361	1/2"	100	1000
362	3/4"	100	1000
363	1"	50	500
364	1 1/4"	10	100
365	1 1/2"	10	100
366	2"	10	100
367	2 1/2"	2	10
368	3"	2	10
369	3 1/2"	---	5
370	4"	---	5
371	5"	---	5
372	6"	---	5

Zinc Die Cast / Nylon Insulator

Catalog Number	Trade Size	Unit Qty.	Std. Qty.
361-DC	1/2"	100	1000
362-DC	3/4"	100	1000
363-DC	1"	50	500
364-DC	1 1/4"	10	100
365-DC	1 1/2"	10	100
366-DC	2"	10	100
367-DC	2 1/2"	2	10
368-DC	3"	2	10
369-DC	3 1/2"	---	5
370-DC	4"	---	5



Pull Caps

Used for capping EMT, rigid and most bushings.
 File No. LR39354

Polypropylene

Catalog Number	Trade Size	Unit Qty.	Std. Qty.
341	1/2"	100	1000
342	3/4"	100	1000
343	1"	100	1000
344	1 1/4"	50	250
345	1 1/2"	25	100
346	2"	25	100



Stud Bushings

Protects wire insulation from abrasion in metal studs. Bushing allows smooth wire pulling.
 Used for all pre-punched shaped holes.

File No. E11259

Polypropylene

Catalog Number	Hole Dia.	Unit Qty.	Std. Qty.
9882	---	50	500

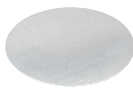
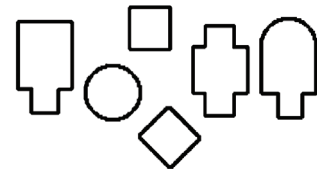

Bushing Pennies

Used inside bushing to prevent foreign matter from entering conduit.

Galvanized Steel

Catalog Number	Trade Size	Unit Qty.	Std. Qty.
1661	1/2"	500	1000
1662	3/4"	250	500
1663	1"	100	200
1664	1 1/4"	50	100
1665	1 1/2"	50	100
1666	2"	50	100
1667	2 1/2"	50	100
1668	3"	50	100
1669	3 1/2"	25	100
1670	4"	25	100
1671	5"	25	100



Insulating Bushing

EMT bushing insulates telephone, computer, video and other low voltage wiring from sharp edges of EMT. Complies with NEC Article 300-15(c).

Polyethylene - 90°C

Catalog Number	Trade Size	Unit Qty.	Std. Qty.
TWB-51	1/2"	100	1000
TWB-52	3/4"	50	500
TWB-53	1"	25	250
TWB-54	1 1/4"	25	250
TWB-55	1 1/2"	---	100
TWB-56	2"	---	50
TWB-57	2 1/2"	---	25
TWB-58	3"	---	25
TWB-59	3 1/2"	---	25
TWB-60	4"	---	25



Knockout Insulating Bushings

Converts metallic box rough edged holes to smooth insulated holes for protection of electrical, voice, data and video cables.

File No. LR24719

File No. E240912 (9791 thru 9796)

Nylon - 105°C

Catalog Number	K.O.	K.O. Dia.	Unit Qty.	Std. Qty.
9791	1/2"	.875"	100	1000
9792	3/4"	1.109"	100	1000
9793	1"	1.375"	50	500
9794	1 1/4"	1.734"	50	500
9795	1 1/2"	1.984"	25	250
9796	2"	2.469"	20	100
9797	2 1/2"	2.969"	20	100