

Screwdrivers, Nut Drivers & Accessories

Offering a variety of tip types, hex sizes, shaft lengths, and handle designs, Klein has the screwdrivers and nut drivers professionals demand to get the job done with comfort and ease of use.

For Professionals...
Since 1857™

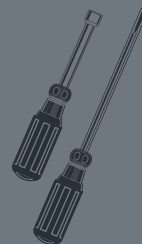

Introduction – Screwdrivers, Nut Drivers & Accessories

Klein screwdrivers give professionals extra-quality features that have made the Klein name famous for hand tools – features that assure greater convenience, comfort and efficiency in use, plus exceptional strength and durability.

All Klein drivers are made of the highest quality tempered steel, carefully heat-treated for maximum strength. Shafts have integral flanges that provide an extra-strong, torque-proof anchor in the handle. Strong, durable black tips are forged and precision ground with square edges to fit screw openings securely. They resist slippage and provide positive turning action.

Cushion-Grip screwdrivers feature super-comfortable, sure-grip handles on top-quality blades for the professional. All Klein screwdrivers meet or exceed applicable ANSI and MIL specifications.

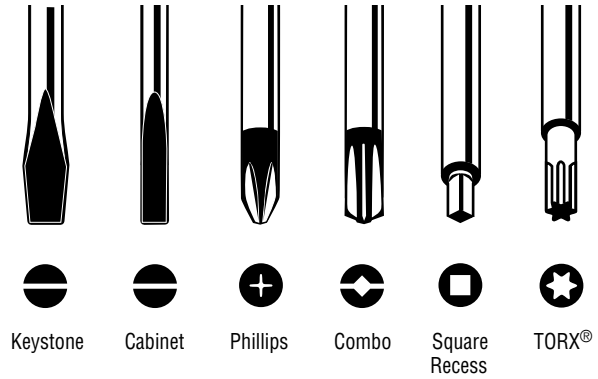

Using Screwdrivers and Nut Drivers

The size of the screw or nut and the type of opening it has determines which driver to use. Here are a few tips on how to use a driver that can be of benefit, because screwdrivers are the most often misused and abused hand tools of all.

- 1. Never use a driver to do another tool's job.**
Using a driver as a pry bar, scraper, or a chisel can ruin the tool, spoil the work and cause injury.
- 2. Never push a driver beyond its capacity.**
Make a pilot hole for the screw for easier driving. Use square-shank drivers for heavy work.
- 3. Never expose a driver to excessive heat.**
Direct flame can draw the temper from the metal, weakening and possibly warping it, making it unsafe and inefficient to use.

- 4. Never use a driver at an angle to the screw.**
Always keep the shank perpendicular to the screw head. Driving at an angle or using a point that is too small can spoil the screw or slip and damage the work.
- 5. Never depend on a driver's handle or covered blade to insulate you from electricity.** Plastic and Cushion-Grip handles are intended only to provide a firm, comfortable grip. Insulated blades are intended only as a protective measure against shorting out components. Only use insulated tools that are marked with the official international 1000-volt rating symbol if there is any chance that the tool will make contact with an energized source.
- 6. Discard damaged or worn drivers.**

TORX® is a registered trademark of Acument Intellectual Properties, LLC.

Cushion-Grip Screwdriver Sets

Features:

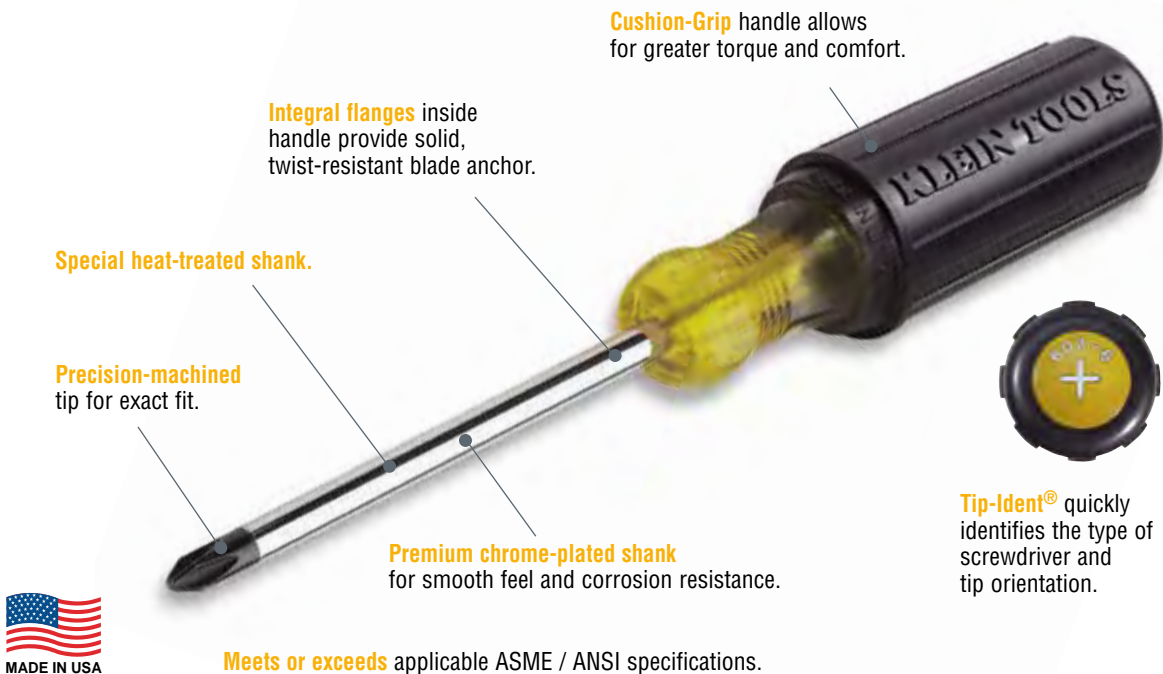

All dimensions are in inches and (millimeters).



www.kleintools.com

See page 310 for additional information on warnings.

Cushion-Grip Screwdriver Sets

8-Piece Screwdriver Set

Additional Features:

- General purpose selection of the most frequently used screwdrivers.
- Includes two cabinet-tip, two keystone-tip, four Phillips-tip styles.

Cat. No.	Set Contains	Weight (lbs.)			
85078		1.65			
Cat. No.	Tip Type	Tip Size	Shank Type	Shank Length	Overall Length
600-4	keystone*	1/4" (6 mm)	square	4" (102 mm)	8-11/32" (212 mm)
602-6	keystone*	5/16" (8 mm)	round	6" (152 mm)	10-15/16" (278 mm)
600-1	cabinet	5/16" (8 mm)	round	1-1/2" (38 mm)	3-7/16" (87 mm)
601-3	cabinet	3/16" (5 mm)	round	3" (76 mm)	6-3/4" (171 mm)
603-3	Phillips	#1	round	3" (76 mm)	6-3/4" (171 mm)
603-1	Phillips	#2	round	1-1/2" (38 mm)	3-7/16" (87 mm)
603-4	Phillips	#2	round	4" (102 mm)	8-5/16" (211 mm)
603-6	Phillips	#3	round	6" (152 mm)	11" (279 mm)

* Heavy-duty models



85078

7-Piece Screwdriver Set

Additional Features:

- General-purpose selection of the most frequently used screwdrivers.
- Includes three cabinet-tip, two Phillips-tip and two keystone-tip styles.

Cat. No.	Set Contains	Weight (lbs.)			
85076		1.50			
Cat. No.	Tip Type	Tip Size	Shank Type	Shank Length	Overall Length
600-4	keystone*	1/4" (6 mm)	square	4" (102 mm)	8-11/32" (212 mm)
602-6	keystone*	5/16" (8 mm)	round	6" (152 mm)	10-15/16" (278 mm)
601-3	cabinet	3/16" (5 mm)	round	3" (76 mm)	6-3/4" (171 mm)
601-6	cabinet	3/16" (5 mm)	round	6" (152 mm)	9-3/4" (248 mm)
605-4	cabinet*	1/4" (6 mm)	round	4" (102 mm)	8-11/32" (212 mm)
603-3	Phillips	#1	round	3" (76 mm)	6-3/4" (171 mm)
603-4	Phillips	#2	round	4" (102 mm)	8-5/16" (211 mm)

* Heavy-duty models

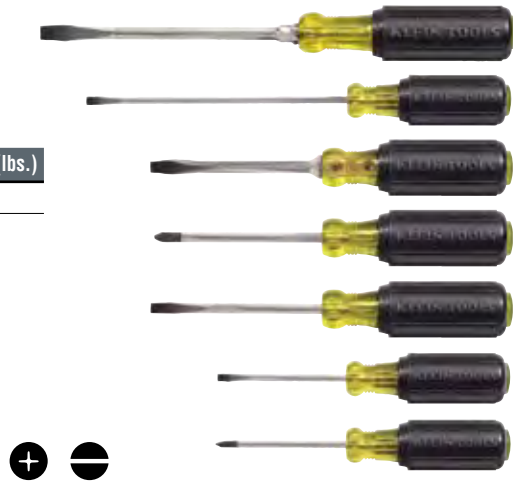

85076

7-Piece Multiple-Application Screwdriver Set

Additional Features:

- Specialty set for a wide variety of applications.
- Includes two cabinet-tip, one Phillips-tip, two keystone-tip, one rotary and one screw-holding screwdriver.

Cat. No.	Set Contains	Weight (lbs.)			
85077		1.65			
Cat. No.	Tip Type	Tip Size	Shank Type	Shank Length	Overall Length
600-4	keystone*	1/4" (6 mm)	square	4" (102 mm)	8-11/32" (212 mm)
602-6	keystone*	5/16" (8 mm)	round	6" (152 mm)	10-15/16" (278 mm)
601-6	cabinet	3/16" (5 mm)	round	6" (152 mm)	9-3/4" (248 mm)
605-6	cabinet*	1/4" (6 mm)	round	6" (152 mm)	10-11/32" (263 mm)
670-6	cabinet Rapi-Drive™	3/16" (5 mm)	round	6" (152 mm)	9-3/4" (248 mm)
K36	slotted screw-holding	N/A	round	6" (152 mm)	9-3/4" (248 mm)
603-4	Phillips	#2	round	4" (102 mm)	8-5/16" (211 mm)

* Heavy-duty models



85077

All dimensions are in inches and (millimeters).



www.kleintools.com

See page 310 for additional information on warnings.

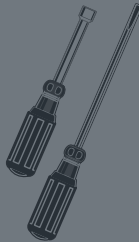

Cushion-Grip Screwdriver Sets

6-Piece Screwdriver Set

Additional Features:

- General-purpose selection of the most frequently used screwdrivers.
- Includes one cabinet-tip, two keystone-tip and three Phillips-tip styles.

Cat. No.	Set Contains	Weight (lbs.)			
85074		1.50			
Cat. No.	Tip Type	Tip Size	Shank Type	Shank Length	Overall Length
600-4	keystone*	1/4" (6 mm)	round	4" (102 mm)	8-11/32" (212 mm)
600-6	keystone*	1/4" (6 mm)	square	6" (152 mm)	10-15/16" (278 mm)
601-3	cabinet	3/16" (5 mm)	round	3" (76 mm)	6-3/4" (171 mm)
603-3	Phillips	#1	round	3" (76 mm)	6-3/4" (171 mm)
603-4	Phillips	#2	round	4" (102 mm)	8-5/16" (211 mm)
603-6	Phillips	#3	round	6" (152 mm)	11" (279 mm)

* Heavy-duty models



85074

5-Piece Screwdriver Set

Additional Features:

- General-purpose selection of the most frequently used screwdrivers.
- Includes two cabinet-tip, one Phillips-tip and two keystone-tip screwdrivers.

Cat. No.	Set Contains	Weight (lbs.)			
85075		1.30			
Cat. No.	Tip Type	Tip Size	Shank Type	Shank Length	Overall Length
602-6	keystone*	5/16" (8 mm)	round	6" (152 mm)	10-15/16" (278 mm)
600-4	keystone*	1/4" (6 mm)	square	4" (102 mm)	8-11/32" (212 mm)
601-6	cabinet	3/16" (5 mm)	round	6" (152 mm)	9-3/4" (248 mm)
605-6	cabinet*	1/4" (6 mm)	round	6" (152 mm)	10-11/32" (263 mm)
603-4	Phillips	#2	round	4" (102 mm)	8-5/16" (211 mm)

* Heavy-duty models



85075

4-Piece Screwdriver Set

Additional Features:

- The screwdrivers professionals carry most often.
- Includes one Phillips-tip, two keystone-tip, one cabinet-tip screwdrivers.

Cat. No.	Set Contains	Weight (lbs.)			
85105		1.50			
Cat. No.	Tip Type	Tip Size	Shank Type	Shank Length	Overall Length
600-6	square	1/4" (6 mm)	square	6" (152 mm)	10-15/16" (278 mm)
600-4	keystone*	1/4" (6 mm)	square	4" (102 mm)	8-11/32" (212 mm)
601-6	cabinet	3/16" (5 mm)	round	6" (152 mm)	9-3/4" (248 mm)
603-4	Phillips	#2	round	4" (102 mm)	8-5/16" (211 mm)

* Heavy-duty models



85105

All dimensions are in inches and (millimeters).

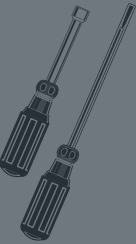

Cushion-Grip Screwdriver Sets

5-Piece Electronics Screwdriver Set

Additional Features

- Rotating cap for optimum and precise control when working on small equipment.
- Includes professional custom carrying case.

Cat. No.	Set Contains				Weight
85614					.80
Cat. No.	Tip Type	Tip Size	Shank Length	Overall Length	
614-2	cabinet	1/16" (2 mm)	2" (51 mm)	5-1/2" (140 mm)	
614-3	cabinet	3/32" (1 mm)	3" (76 mm)	6-1/2" (165 mm)	
614-4	cabinet	1/8" (3 mm)	4" (102 mm)	7-1/2" (191 mm)	
614-6	cabinet	1/8" (3 mm)	6" (152 mm)	9-1/2" (241 mm)	
613-3	Phillips	#0	3" (76 mm)	6-1/2" (165 mm)	



85614

4-Piece Miniature Screwdriver Set

Additional Feature:

- Precision tips for exact fit and rigorous applications.

Cat. No.	Set Contains				Weight (lbs.)
85484					.14
Cat. No.	Tip Type	Tip Size	Shank Length	Overall Length	
604-3	Phillips	#0	3" (76 mm)	5-3/4" (146 mm)	
606-2	keystone	1/16" (1.6 mm)	2" (51 mm)	4-3/4" (121 mm)	
607-3	cabinet	3/32" (1 mm)	3" (76 mm)	5-3/4" (146 mm)	
608-3	cabinet	1/8" (3 mm)	3" (76 mm)	5-3/4" (146 mm)	

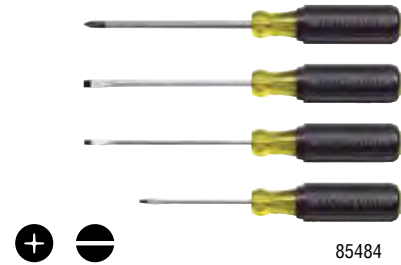

85484

5-Piece TORX® Screwdriver Set

Additional Features:

- TORX® drive systems transmit more torque to the work and reduce slippage, saving fasteners.
- Chrome-plated shafts resist corrosion.

Cat. No.	Set Contains				Weight (lbs.)
19555					1.20
Cat. No.	TORX® Size	Color Code	Shank Length	Overall Length	
19542	T15	yellow	4" (102 mm)	7-3/4" (197 mm)	
19543	T20	green	4" (102 mm)	7-3/4" (197 mm)	
19544	T25	blue	4" (102 mm)	7-3/4" (197 mm)	
19545	T27	brown	4" (102 mm)	8-5/16" (211 mm)	
19546	T30	red	4" (102 mm)	8-5/16" (211 mm)	



19555

TORX® is a registered trademark of Acument Intellectual Properties, LLC.

2-Piece Combo-Tip Screwdriver Set **NEW!**

Additional Features:

- #1 and #2 combination tips.
- Precision machined tip designed for combination head screws.

Cat. No.	Set Contains				Weight (lbs.)
32378					1.50
Cat. No.	Tip Type	Shank Length	Overall Length		
731-4	#1 combo	4" (102 mm)	8-11/32" (212 mm)		
732-4	#2 combo	4" (102 mm)	8-11/32" (212 mm)		



32378

All dimensions are in inches and (millimeters).



www.kleintools.com

See page 310 for additional information on warnings.

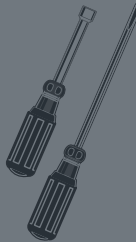

Cushion-Grip Screwdriver Sets

2-Piece 10" Long Blade Screwdriver Set

Additional Features:

- Phillips-tip is precision-machined to provide a more consistent geometric symmetry than conventional Phillips-tip screwdrivers.
- Precision-ground narrow cabinet-tip permits blade access where space is limited.
- Ideal for hard-to-reach places where added length is necessary.
- Includes one Phillips-tip and one cabinet-tip.

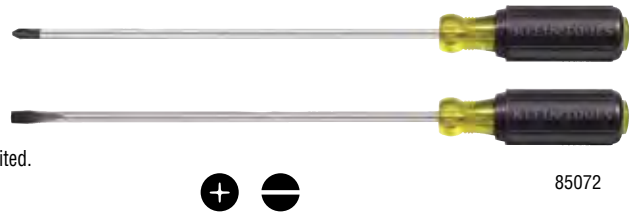

85072

Cat. No.	Set Contains	Weight (lbs.)			
85072		.70			
Cat. No.	Tip Type	Tip Size	Shank Type	Shank Length	Overall Length
603-10	profilated Phillips	#2	round	10" (254 mm)	14-5/16" (363 mm)
605-10	cabinet	3/16" (5 mm)	round	10" (254 mm)	14-5/16" (363 mm)

2-Piece Demolition Screwdriver Set



Additional Features:

- Engineered, manufactured and tested for prying, chiseling and punching
- Plated metal strike cap to protect handle from hammer blows.
- Heat treated metal shaft runs complete length of handle to metal strike cap to transfer metal strike force.

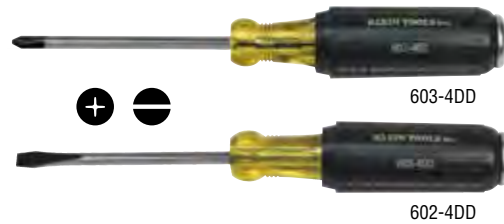

603-4DD

602-4DD

Cat. No.	Set Contains	Weight (lbs.)			
32008		.70			
Cat. No.	Tip Type	Tip Size	Shank Type	Shank Length	Overall Length
602-4DD	profilated Phillips	#2	round	4" (102 mm)	9" (229 mm)
603-4DD	cabinet	1/4" (6 mm)	round	4" (102 mm)	9" (229 mm)

4-Piece Square Recess Screwdriver Set

Additional Feature:

- Works on most combination head receptacle, switch and panel screws.

Cat. No.	Set Contains	Weight (lbs.)			
85664		1.50			
Cat. No.	Point Size	Color Code	Shank Type	Shank Length	Overall Length
660	#0	yellow	round	4" (102 mm)	7-3/4" (197 mm)
661	#1	green	round	4" (102 mm)	7-3/4" (197 mm)
662	#2	red	round	4" (102 mm)	8-5/16" (211 mm)
663	#3	black	round	4" (102 mm)	8-5/16" (211 mm)



85664

2-Piece Stubby Screwdriver Set

Additional Feature:

- Double wings inside handle provide solid, twist-resistant blade anchor.



85071

Cat. No.	Set Contains	Weight (lbs.)			
85071		.30			
Cat. No.	Tip Type	Tip Size	Shank Type	Shank Length	Overall Length
600-1	cabinet	5/16" (8 mm)	round	1-1/2" (38 mm)	3-7/16" (87 mm)
603-1	Phillips	#2	round	1-1/2" (38 mm)	3-7/16" (87 mm)

Stubby Square-Recess Tip Screwdriver Set

Additional Features:

- Double wings inside handle provide solid, twist-resistant blade anchor.
- Works on most combination head receptacle and switch screws.
- Color-coded handle ends for quick and easy identification.



85155

Cat. No.	Set Contains	Weight (lbs.)			
85155		.30			
Cat. No.	Tip Size	Color Code	Shank Type	Shank Length	Overall Length
668	#1	green	round	1-1/2" (38 mm)	3-7/16" (87 mm)
669	#2	red	round	1-1/2" (38 mm)	3-7/16" (87 mm)

All dimensions are in inches and (millimeters).



Switch Drive™ System

NEW!

Switch Drive™ Handle Power Driver Sets

Additional Features:

- Allows for easy alternating between power tool and hand tool on job site.
- Quick-Release mechanism converts power tool accessory to hand tool in a snap.
- Includes Switch Drive™ handle (Cat. No. 32698).



Cat. No.	Tip Type	Tip Size	Bit Length	Overall Length	Weight (lbs.)
32700	Phillips and square recess	#2	6" (152 mm)	14-5/16" (363 mm)	.70
32702	Phillips	#1 & #2	6" (152 mm)	14-5/16" (363 mm)	.70
32703	square recess	#1 & #2	6" (152 mm)	14-5/16" (363 mm)	.70

Switch between **handle**
and **drill** in a snap!

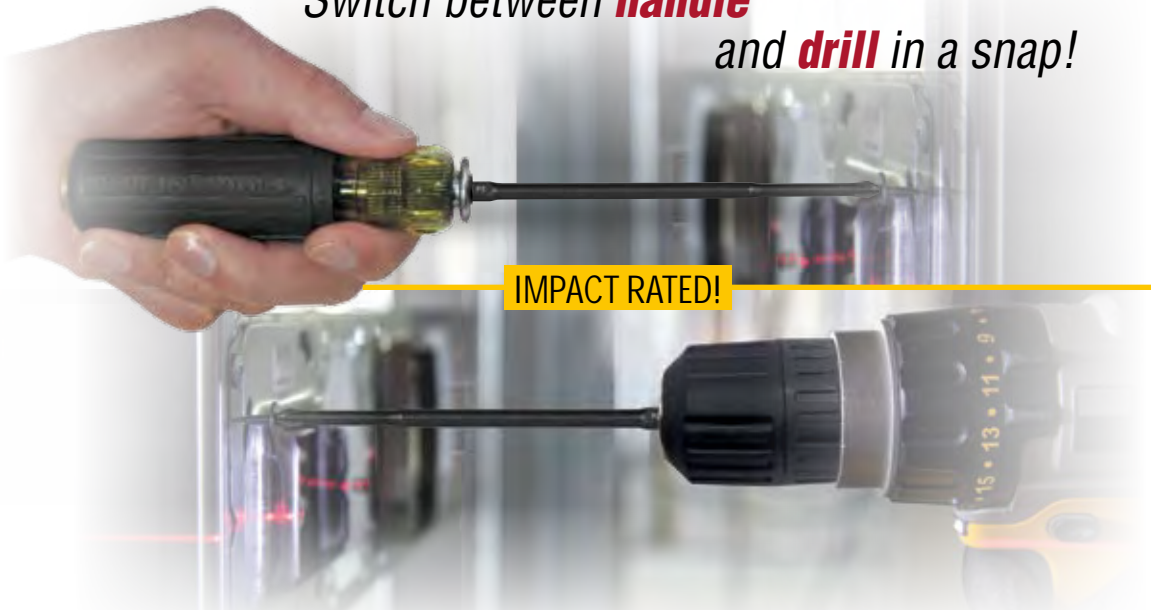

NOTE: Read and follow safety instructions in power tool owner's manual.

All dimensions are in inches and (millimeters).



www.kleintools.com

See page 310 for additional information on warnings.

Screwdrivers, Nut Drivers
& Accessories

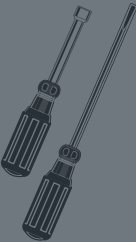

Cushion-Grip Screwdrivers

Keystone-Tip Screwdrivers – Heavy-Duty Square-Shanks

Additional Features:

- Heavy-duty square shank for wrench-assisted turning.
- Bolster reinforces shank for hard use.
- Designed for the most demanding uses.



Cat. No.	Tip Size	Shank Length	Overall Length	Weight (lbs.)
600-4	1/4" (6 mm)	4" (102 mm)	8-11/32" (212 mm)	.25
600-6	5/16" (8 mm)	6" (152 mm)	10-15/16" (278 mm)	.40

Cat. No.	Tip Size	Shank Length	Overall Length	Weight (lbs.)
600-8	3/8" (10 mm)	8" (203 mm)	13-7/16" (341 mm)	.65
600-12	1/2" (13 mm)	12" (305 mm)	17-7/16" (443 mm)	.80

Keystone-Tip Screwdrivers – Heavy-Duty Round-Shanks

Additional Features:

- Built to handle the tough jobs with ease.
- Hex bolster reinforces shank for hard use and allows wrench assisted turning.



Cat. No.	Tip Size	Shank Length	Overall Length	Weight (lbs.)
602-3	7/32" (5 mm)	3" (76 mm)	6-3/4" (171 mm)	.15
600-1	5/16" (8 mm)	1-1/2" (38 mm)	3-7/16" (87 mm)	.10
602-4	1/4" (6 mm)	4" (102 mm)	8-11/32" (212 mm)	.25

Cat. No.	Tip Size	Shank Length	Overall Length	Weight (lbs.)
602-6	5/16" (6 mm)	6" (152 mm)	10-15/16" (278 mm)	.35
602-8	3/8" (10 mm)	8" (203 mm)	13-7/16" (341 mm)	.55
602-10	3/8" (10 mm)	10" (254 mm)	15-7/16" (392 mm)	.60
602-12	3/8" (10 mm)	12" (305 mm)	17-7/16" (443 mm)	.65

* Bolster not available on Cat. No. 600-1

Cabinet-Tip Screwdrivers – Round-Shanks

Additional Feature:

- Narrow cabinet-tip permits blade access where space is limited.



Cat. No.	Tip Size	Shank Length	Overall Length	Weight(lbs.)
601-4	3/16" (5 mm)	4" (102 mm)	7-3/4" (197 mm)	.15
601-6	3/16" (5 mm)	6" (152 mm)	9-3/4" (248 mm)	.15
601-8	3/16" (5 mm)	8" (203 mm)	11-3/4" (298 mm)	.20
601-10	3/16" (5 mm)	10" (254 mm)	13-3/4" (349 mm)	.20

Cat. No.	Tip Size	Shank Length	Overall Length	Weight(lbs.)
Heavy-Duty Shanks				
605-4	1/4" (6 mm)	4" (102 mm)	8-11/32" (212 mm)	.25
605-6	1/4" (6 mm)	6" (152 mm)	10-11/32" (263 mm)	.30
605-8	1/4" (6 mm)	8" (203 mm)	12-11/32" (314 mm)	.30
605-10	1/4" (6 mm)	10" (254 mm)	14-11/32" (365 mm)	.35

Combo-Tip Screwdrivers – Round-Shanks

Additional Feature:

- Precision machined tip designed for combination head screws.

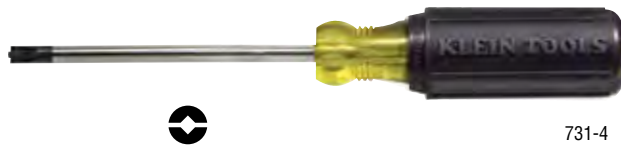

Cat. No.	Tip Size	Shank Length	Overall Length	Weight (lbs.)
731-4	#1 combo	4" (102 mm)	8-11/32" (212 mm)	.30
732-4	#2 combo	4" (102 mm)	8-11/32" (212 mm)	.30

Profilated Phillips-Tip Screwdrivers – Round-Shanks

Additional Features:

- Precision-machined tips provide a more consistent geometric symmetry than conventional Phillips screwdrivers.
- Provides accurate fit and torque without slippage.



Cat. No.	Tip Size	Shank Length	Overall Length	Weight (lbs.)
603-1	#2	1-1/2" (38 mm)	3-7/16" (87 mm)	.10
603-3	#1	3" (76 mm)	6-3/4" (171 mm)	.15
603-4	#2	6" (152 mm)	11" (279 mm)	.35

Cat. No.	Tip Size	Shank Length	Overall Length	Weight (lbs.)
603-6	#3	6" (152 mm)	11" (279 mm)	.35
603-7	#2	7" (178 mm)	11-5/16" (287 mm)	.30
603-10	#2	10" (254 mm)	14-5/16" (364 mm)	.35

All dimensions are in inches and (millimeters).



Cushion-Grip Screwdrivers

Electronics Screwdrivers

Additional Feature:

- Rotating cap for optimum and precise control.

Cat. No.	Tip Type	Tip Size	Shank Length	Overall Length	Weight (lbs.)
614-2	cabinet	1/16"	2" (51 mm)	5-1/2" (140 mm)	.05
613-3	Phillips	#0	3" (76 mm)	6-1/2" (165 mm)	.05
614-3	cabinet	3/32"	3" (76 mm)	6-1/2" (165 mm)	.05



614-6

Cat. No.	Tip Type	Tip Size	Shank Length	Overall Length	Weight (lbs.)
614-4	cabinet	1/8"	4" (102 mm)	7-1/2" (191 mm)	.05
614-6	cabinet	1/8"	6" (152 mm)	9-1/2" (241 mm)	.05

Miniature Screwdrivers

Additional Feature:

- Precision tip for exact fit and rigorous applications.

Cat. No.	Tip Type	Tip Size	Shank Length	Overall Length	Weight (lbs.)
604-3	Phillips	#0	3" (76 mm)	5-3/4" (146 mm)	.04
606-2	keystone	1/16" (1.5 mm)	2" (51 mm)	4-3/4" (121 mm)	.03
607-2	cabinet	3/32" (2 mm)	2" (51 mm)	4-3/4" (121 mm)	.03
607-3	cabinet	3/32" (2 mm)	3" (76 mm)	5-3/4" (146 mm)	.04
607-4	cabinet	3/32" (2 mm)	4" (102 mm)	6-3/4" (171 mm)	.04
608-2	cabinet	1/8" (3 mm)	2" (51 mm)	4-3/4" (121 mm)	.03



608-6

Cat. No.	Tip Type	Tip Size	Shank Length	Overall Length	Weight (lbs.)
608-3	cabinet	1/8" (3 mm)	3" (76 mm)	5-3/4" (146 mm)	.04
608-4	cabinet	1/8" (3 mm)	4" (102 mm)	6-3/4" (171 mm)	.05
608-6	cabinet	1/8" (3 mm)	6" (152 mm)	8-3/4" (222 mm)	.05
608-8	cabinet	1/8" (3 mm)	8" (203 mm)	10-3/4" (273 mm)	.05
608-10	cabinet	1/8" (3 mm)	10" (254 mm)	12-3/4" (324 mm)	.05

Coated Cabinet-Tip Screwdrivers – Round-Shanks

Additional Features:

- Plastic coated for circuit protection only. NOT INSULATED.
- Special plastic coating resists cutting, cracking and chipping.
- Thin coating permits use in confined areas.

Cat. No.	Tip Size	Shank Length	Overall Length	Weight (lbs.)
620-3	3/16" (5 mm)	3" (76 mm)	6-3/4" (171 mm)	.15
621-6	3/16" (5 mm)	6" (152 mm)	9-3/4" (248 mm)	.20
621-8	3/16" (5 mm)	8" (203 mm)	11-3/4" (298 mm)	.20
621-10	3/16" (5 mm)	10" (254 mm)	13-3/4" (349 mm)	.25



620-4

Cat. No.	Tip Size	Shank Length	Overall Length	Weight (lbs.)
Heavy-Duty Shanks				
620-4	1/4" (6 mm)	4" (102 mm)	8-11/32" (212 mm)	.20
620-6	5/16" (8 mm)	6" (152 mm)	10-15/16" (278 mm)	.40
620-8	3/8" (10 mm)	8" (203 mm)	13-7/16" (341 mm)	.60

Square-Recess Tip Screwdrivers – Round-Shanks

Additional Features:

- Color-coded handle ends for quick and easy identification.
- Chrome plated shank for corrosion resistance.

Cat. No.	Tip Size	Color Code	Shank Length	Overall Length	Weight (lbs.)
660	#0	yellow	4" (102 mm)	7-3/4" (197 mm)	.20
661	#1	green	4" (102 mm)	7-3/4" (197 mm)	.20
662	#2	red	4" (102 mm)	8-1/4" (210 mm)	.30
663	#3	black	4" (102 mm)	8-1/4" (210 mm)	.30



660

Cat. No.	Tip Size	Color Code	Shank Length	Overall Length	Weight (lbs.)
665	#1	green	8" (203 mm)	11-3/4" (298 mm)	.30
666	#2	red	8" (203 mm)	12-1/4" (311 mm)	.40
667	#3	black	8" (203 mm)	12-1/4" (311 mm)	.40

All dimensions are in inches and (millimeters).



www.kleintools.com

See page 310 for additional information on warnings.

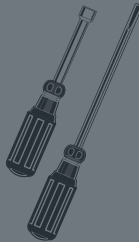

Cushion-Grip Screwdrivers

TORX® Screwdrivers – Round-Shanks

Additional Features:

- TORX® tip drive cuts slippage, saves fasteners and transmits more torque to the work.
- Color-coded handle ends for quick and easy identification.



19544

Cat. No.	TORX® Size	Color Code	Shank Length	Overall Length	Weight (lbs.)
19542	T15	yellow	4" (102 mm)	8-5/16" (211 mm)	.20
19543	T20	green	4" (102 mm)	8-5/16" (211 mm)	.25
19544	T25	blue	4" (102 mm)	8-5/16" (211 mm)	.25

Cat. No.	TORX® Size	Color Code	Shank Length	Overall Length	Weight (lbs.)
19545	T27	brown	4" (102 mm)	8-5/16" (211 mm)	.25
19546	T30	red	4" (102 mm)	8-5/16" (211 mm)	.25

TORX® is a registered trademark of Acument Intellectual Properties, LLC.

Demolition Screwdrivers

Additional Features:

- Engineered, manufactured and tested for prying, chiseling and punching
- Plated metal strike cap to protect handle from hammer blows.
- Heat treated metal shaft runs complete length of handle to metal strike cap to transfer metal strike force.



602-7DD

NEW!



603-4DD

Cat. No.	Tip Type	Tip Size	Blade Length	Overall Length	Weight (lbs.)
602-4DD	keystone	1/4" (6 mm)	4" (102 mm)	9" (229 mm)	.37
602-7DD	keystone	5/16" (8 mm)	7" (178 mm)	12-3/8" (314 mm)	.56
603-4DD	Phillips	#2	7" (178 mm)	9" (229 mm)	.37 NEW!



Rapi-Driv™ Cushion-Grip Screwdrivers

Rapi-Driv® Screwdrivers

Additional Features:

- Crank-action handle spins screws fast with one hand.
- Saves time and effort, especially on long-threaded screws in switch plates, light fixtures, etc.



670-6

Cat. No.	Tip Type	Tip Size	Shank Length	Overall Length	Weight (lbs.)
670-3	cabinet	3/16" (5 mm)	4" (102 mm)	7-3/4" (197 mm)	.15
670-6	cabinet	3/16" (5 mm)	6" (152 mm)	9-3/4" (248 mm)	.20
671-6	cabinet	1/4" (6 mm)	6" (152 mm)	9-3/4" (248 mm)	.20
681-6	Phillips	#1	6" (152 mm)	9-3/4" (248 mm)	.20
682-6	Phillips	#2	6" (152 mm)	9-3/4" (248 mm)	.25
691-6	square-recess	#1	6" (152 mm)	9-3/4" (248 mm)	.35
692-6	square-recess	#2	6" (152 mm)	9-3/4" (248 mm)	.35

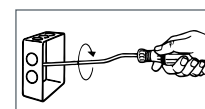

Interchangeable Rapi-Driv™

Additional Features:

- Interchangeable bit holder allows quick switching between tip styles and works with other standard size bits.
- Crank-action handle allows you to spin screws fast with one hand.
- Blast finish bit provides firm grip on fasteners to reduce cam out.



67100

Cat. No.	Contains	Shaft Length	Overall Length	Weight (lbs.)
67100	3/16" (5 mm) slotted, #2 Phillips	6" (152 mm)	9-3/4" (248 mm)	.26

2-in-1 Replacement Bit

Cat. No.	Fits	Description	Quantity	Weight (lbs.)
67101	2-in-1 Rapi-Driv™, 10-in-1, 11-in-1 and 10-Fold™	3/16" (5 mm) slotted, #2 Phillips replacement bit	contains 2 bits	.012

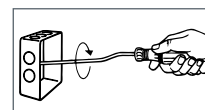

All dimensions are in inches and (millimeters).



www.kleintools.com

See page 310 for additional information on warnings.

Conduit Reamers

Power Conduit Reamer

- Ream 1/2" (13 mm), 3/4" (19 mm), and 1" (25 mm) conduit and install fittings in a fraction of the time.
- Designed to fit into power drill chucks and quick release adapters; impact ready.
- Includes precision engineered replaceable reaming blade.
- Replacement blades are available and the only approved blade for use in this tool.
- Replacement bits are available but any standard 1/4" hex bit will work.



85091



Cat. No.	Description	Weight (lbs.)
85091	conduit reamer drill head for 1/2" (13 mm), 3/4" (19 mm), 1" (25 mm) conduit	.33 lbs.
19353	conduit reamer replacement blade	.01 lbs.
SQ2115	#2 square recess replacement bit, 15-pack	.01 lbs.

NOTE: Read and follow safety instructions in power tool owner's manual.

Conduit-Fitting and Reaming Screwdriver

Additional Features:

- Hooded-blade design keeps tip from slipping out of screws, especially when tightening hard-to-reach conduit fittings. Thicker hood is designed for rugged use.
- Reams and smooths 1/2" (13 mm), 3/4" (19 mm), and 1" (25 mm) thin-wall conduit ends to protect wire and permit correct installation of fittings.
- Reams both the inside and outside of the conduit at the same time.
- Replaceable reaming blade is now held in place with a 1/16" (1.5 mm) set screw.



85191

Cat. No.	Tip Size	Shank Length	Overall Length	Weight (lbs.)
85191	5/16" (8 mm)	2-1/2" (64 mm)	7-1/2" (191 mm)	.50
19353	conduit reamer replacement blade kit			.01

Conduit Reamer

- Locks onto screwdrivers; reams and smooths thin-wall conduit.
- Reams ID and OD at the same time.
- Two set-screws for round- and square-shank screwdrivers.
- Fits up to 3/8" (10 mm) keystone-tip screwdrivers.
- NOT for use on power tools.



19352

Cat. No.	Conduit Capacity	Weight (lbs.)
19352	1/2" (13 mm), 3/4" (19 mm), 1" (25 mm)	.20
19353	conduit reamer replacement blade kit for 19352	.01

Specialty Cushion-Grip Screwdrivers

Screw-Holding Screwdrivers

Additional Features:

- Starts and drives screws with one hand when working in hard-to-reach spaces.



32215

Cat. No.	Tip Type	Tip Type	Shank Length	Overall Length	Weight (lbs.)
32215	cabinet	1/4" (6 mm)	7" (178 mm)	11-1/4" (276 mm)	0.32
32216	Phillips	#2	7" (178 mm)	11-1/4" (276 mm)	0.32

All dimensions are in inches and (millimeters).



www.kleintools.com

See page 310 for additional information on warnings.

Specialty Cushion-Grip Screwdrivers

Terminal Block Screwdriver

Additional Features:

- Precision-machined cabinet tip provides exact fit for terminal block screws.
- Tip is up to 19% stronger than competitors and provides 76% higher torque value than the required ASME B107 Standard.

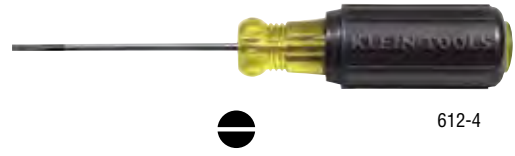

Cat. No.	Shank Tip Width	Shank Length	Overall Length	Weight (lbs.)
612-4	1/8" (3 mm)	4" (100 mm)	7-3/4" (200 mm)	0.15

Wire Bending Screwdrivers – Round-Shanks

Additional Feature:

- Metal stud offers a convenient and easy way to bend, loop and connect solid wire when installing outlets and switches.

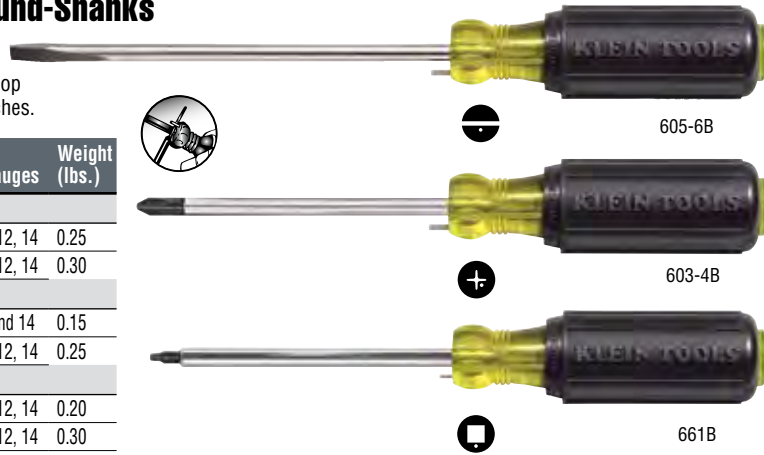

Cat. No.	Tip Size	Shank Length	Overall Length	Bends AWG Gauges	Weight (lbs.)
Cabinet Tip					
605-4B	1/4" (6 mm)	4" (102 mm)	8-11/32" (212 mm)	Nos. 10, 12, 14	0.25
605-6B	1/4" (6 mm)	6" (152 mm)	10-11/32" (263 mm)	Nos. 10, 12, 14	0.30
Phillips Tip					
603-3B	#1	3" (76 mm)	6-3/4" (171 mm)	Nos. 12 and 14	0.15
603-4B	#2	4" (102 mm)	8-5/16" (211 mm)	Nos. 10, 12, 14	0.25
Square Recess					
661B	#1	4" (102 mm)	8-1/4" (210 mm)	Nos. 10, 12, 14	0.20
662B	#2	4" (102 mm)	8-1/4" (210 mm)	Nos. 10, 12, 14	0.30

Multi-Bit Cushion-Grip Screwdrivers/Nut Drivers

Heavy-Duty Multi-Bit Screwdriver/Nut Driver

- Superior torque for tough applications.
- Interchangeable shaft holds six universal tips; converts to three nut driver sizes and one hex driver
- Strong, heat-treated nut drivers for improved torque.



Cat. No.	Shaft Length	Overall Length	Weight (lbs.)
32557	2.95" (75 mm)	7.9" (201 mm)	0.48



Ratcheting Multi-Bit Screwdriver/Nut Driver

- High torque 3-way ratcheting mechanism, forward, reverse and locked positions for tough applications.
- Interchangeable shaft holds six universal tips; converts to three nut driver sizes and one hex driver
- Strong, heat-treated nut drivers for improved torque.



Cat. No.	Shaft Length	Overall Length	Weight (lbs.)
32558	2.95" (75 mm)	7.9" (201 mm)	0.48



Extended-Reach Multi-Bit Screwdrivers/Nut Drivers

- Interchangeable shaft holds four universal tips and converts to two nut driver sizes.
- Extended shafts and blades provide 39% longer reach.
- Small diameter shaft for comfortable grip and quick, easy turning.



Cat. No.	Shaft Length	Overall Length	Weight (lbs.)
32559	4.11" (104 mm)	9.1" (231 mm)	0.41
32560	4.11" (104 mm)	9.1" (231 mm)	0.41

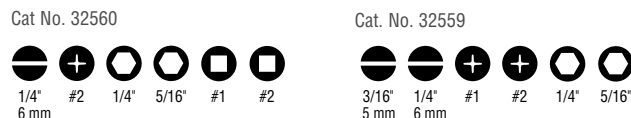

All dimensions are in inches and (millimeters).



Multi-Bit Cushion-Grip Screwdrivers/Nut Drivers

Stubby Multi-Bit Screwdriver/Nut Driver

- Compact design features standard 1-1/4" (32 mm) shaft allowing easy access to tight work spaces.
- Shaft holds four universal tips and converts to two nut driver sizes.

Cat. No.	Shaft Length	Overall Length	Weight (lbs.)
32561	1.27" (32 mm)	3.4" (86 mm)	0.16
32562	1.27" (32 mm)	3.4" (86 mm)	0.16

Cat. No. 32561



Cat. No. 32562

32561



US Patent: D684836



Multi-Bit Screwdrivers/Nut Drivers

- Integrated screwdriver/nut driver shaft holds popular tips and converts nut driver sizes.

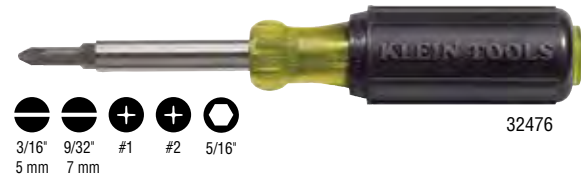

32476



32477



Cat. No.	Description	Shaft Length	Overall Length	Weight (lbs.)
32476	5-in-1	4" (100 mm)	7-3/4" (200 mm)	0.48
32477	10-in-1	4" (100 mm)	7-3/4" (200 mm)	0.50
32500	11-in-1	4" (100 mm)	7-3/4" (200 mm)	0.50

Note: Cat. No. 32476 has 5/16" nut driver only
TORX® is a registered trademark of Acument Intellectual Properties, LLC.



32500



11-in-1 Screwdriver/Nut Driver with Schrader® Valve Removal/ Installation Bit

- Great for HVAC and other industrial applications.
- Includes unique style bit for installation/removal of common TR-4 Schrader® valves and aggressive thread extractor tip for backing out broken cores.

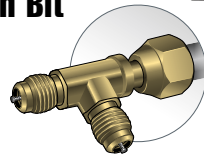

32527

Cat. No.	Shaft Length	Overall Length	Weight (lbs.)
32527	4" (100 mm)	7-3/4" (200 mm)	0.50

Schrader® is a registered trademark of Schrader-Bridgeport International, Inc.



11-in-1 Combo-Tip Screwdriver/Nut Driver

NEW!

- Precision machined tip designed for combination head screws.
- Includes #1 & #2 combination, slotted, square and Phillips tips.

Cat. No.	Shaft Length	Overall Length	Weight (lbs.)
32505	4" (100 mm)	7-3/4" (200 mm)	0.50



32505



Multi-Bit Tap Tool Driver

NEW!

- Increases job speed by combining taps and drivers in one tool.
- Six common tap sizes (6-32, 8-32, 10-32, 10-24, 12-24, 1/4-20).

Cat. No.	Shaft Length	Overall Length	Weight (lbs.)
32517	4" (100 mm)	7-3/4" (200 mm)	0.50

Replacement Tap	Weight (lbs.)
32518 Tap sizes 6-32, 8-32, 10-32, 10-24, 12-24, 1/4-20	0.05



32517



All dimensions are in inches and (millimeters).



www.kleintools.com

See page 310 for additional information on warnings.

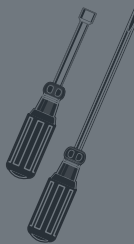

Multi-Bit Screwdrivers/Nut Drivers

10-in-1 Folding Screwdriver/Nut Driver *10-FOLD™*

- Conveniently folds up for easy storage or to fit into your pocket.
- Each driver arm contains four interchangeable bit styles and two nut drivers.
- Unfold each driver arm up to a full 180° for straight on driving power, or at 90° for extra leverage on stubborn fasteners.
- The quick release button easily unlocks a fully extended driver arm.

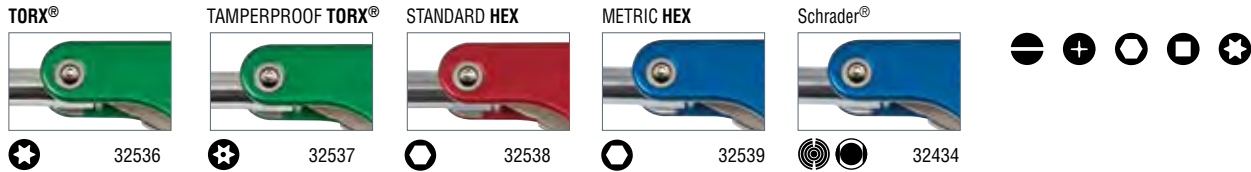

Cat. No.	Handle Color	Screwdrivers	Nut Drivers	Hex	Weight (lbs.)
32535	black	#1 and #2 Phillips, 1/4" (6 mm) & 3/16" (5 mm) slotted, T10 & T15 TORX®, #1 and #2 square-recess	5/16" & 1/4"	N/A	0.37
32536	green	T6, T7, T8, T10, T15, T20, T25, T27 TORX®	5/16" & 1/4"	N/A	0.37
32537	green	T7, T8, T9, T10, T15, T20, T25, T27 TORX®	5/16" & 1/4"	N/A	0.37
32538	red	N/A	5/16" & 1/4"	1/16" (1.5 mm), 5/64" (2 mm), 3/32" (2.3 mm), 7/64" (2.5 mm), 1/8" (3 mm), 9/64" (3.5 mm), 5/32" (4 mm), 3/16" (5 mm)	0.37
32539	blue	N/A	8 mm & 6 mm	.9 mm, 1.3 mm, 1.5 mm, 2 mm, 2.5 mm, 3 mm, 4 mm, 5 mm	0.37
32534	blue	#1 and #2 Phillips, 1/4" (6 mm) & 3/16" (5 mm) slotted, #1 and #2 square-recess and valve core removal/installation - extractor	5/16" & 1/4"	N/A	0.37

Schrader® is a registered trademark of Schrader-Bridgeport International, Inc.
TORX® is a registered trademark of Acument Intellectual Properties, LLC.

Replacement Parts Multi-Bit Screwdriver/Nut Drivers

Replacement Parts for Multi-Bit Screwdriver/Nut Drivers

- Precision-machined tips for exact fit into fastener.



Cat. No.	Fits	Description	Quantity
32392	Heavy Duty (32557) & Ratcheting (32558)	Heavy Duty Main Blade Barrel	1 unit
32394	Heavy Duty (32557) & Ratcheting (32558)	Heavy Duty Secondary Blade Barrel	2 units
32395	Extended Reach Drivers (32559 & 32560)	Extended Blade Barrel	1 unit
32396	Stubby Drivers (32561 & 32562)	Stubby Blade Barrel	1 unit
32397	Heavy Duty (32557) & Ratcheting (32558)	Screwdriver Bit & #2 Phillips x #1 Square	2 bits
32398	Heavy Duty (32557), Ratcheting (32558) & Stubby (32561)	Screwdriver Bit & #1 Phillips x 1/4" (6 mm) Slotted	2 bits
32399	Heavy Duty (32557) & Ratcheting (32558)	Screwdriver Bit & #2 Square x 3/16" (5 mm) Slotted	2 bits
32400	Extended Reach (32559)	Extended Screwdriver Bit & #2 Phillips x #1 Phillips	2 bits
32401	Extended Reach (32559)	Extended Screwdriver Bit & 3/16" (5 mm) and 1/4 (6 mm) Slotted	2 bits
32410	Stubby Driver (32560)	Extended Screwdriver Bit & #2 Square x #2 Phillips	2 bits
32411	Stubby Driver (32560)	Extended Screwdriver Bit & #1 Square x 1/4" (6 mm) Slotted	2 bits
32412	Stubby Driver (32561)	Screwdriver Bit & #2 Phillips x 3/16" (5 mm) Slotted	2 bits

Replacement Bits for 5-in-1 Multi-Bit Screwdriver/Nut Driver



Cat. No.	Fits	Description	Quantity
32478	5-in-1 (32476)	#1 Phillips - 3/16" (5 mm) slotted	1 bit
32479	5-in-1 (32476)	#2 Phillips - 9/32" (7 mm) slotted	1 bit

All dimensions are in inches and (millimeters).



Replacement Parts Multi-Bit Screwdriver/Nut Drivers

Replacement Bits for Multi-Bit Screwdriver/Nut Drivers 10-in-1, 11-in-1 & 10-Fold™



Cat. No.	Fits	Description	Quantity
32482	10-in-1, 11-in-1 & 10-Fold™	#1 Phillips & 3/16" (5 mm) Slotted	2 bits
32483	10-in-1, 11-in-1 & 10-Fold™	#2 Phillips & 1/4" (6 mm) Slotted	2 bits
32484	10-in-1, 11-in-1 & 10-Fold™	#1 Square & #2 Square	2 bits
67101	10-in-1, 11-in-1 & 10-Fold™	#2 Phillips & 3/16" (5 mm) Slotted	2 bits
32518	Multi-Bit Tap Tool (32517)	Double ended tap 6-32, 8-32, 10-32, 10-24, 12-24, 1/4-20	6 taps NEW!
32528	11-in-1 Schrader (32527)	valve core removal/installation – extractor	1 bit
32540	10-in-1, 11-in-1 & 10-Fold™	TT7 & TT8 Tamperproof TORX®	2 bits
32541	10-in-1, 11-in-1 & 10-Fold™	TT9 & TT10 Tamperproof TORX®	2 bits
32542	10-in-1, 11-in-1 & 10-Fold™	TT15 & TT20 Tamperproof TORX®	2 bits
32543	10-in-1, 11-in-1 & 10-Fold™	TT25 & TT27 Tamperproof TORX®	2 bits
32544	10-in-1, 11-in-1 & 10-Fold™	T6 & T7 TORX®	2 bits

Cat. No.	Fits	Description	Quantity
32485	10-in-1, 11-in-1 & 10-Fold™	T10 & T15 TORX®	2 bits
32545	10-in-1, 11-in-1 & 10-Fold™	T8 & T10 TORX®	2 bits
32546	10-in-1, 11-in-1 & 10-Fold™	T25 & T27 TORX®	2 bits
32547	10-in-1, 11-in-1 & 10-Fold™	3/32" & 7/64" Hex	2 bits
32548	10-in-1, 11-in-1 & 10-Fold™	5/32" & 3/16" Hex	2 bits
32549	10-in-1, 11-in-1 & 10-Fold™	1/16" & 5/64" Hex	2 bits
32550	10-in-1, 11-in-1 & 10-Fold™	1/8" & 9/64" Hex	2 bits
32551	10-in-1, 11-in-1 & 10-Fold™	.9 mm Hex & 1.3 mm Hex	2 bits
32552	10-in-1, 11-in-1 & 10-Fold™	1.5 mm Hex & 2 mm Hex	2 bits
32553	10-in-1, 11-in-1 & 10-Fold™	2.5 mm Hex & 3 mm Hex	2 bits
32554	10-in-1, 11-in-1 & 10-Fold™	4 mm Hex & 5 mm Hex	2 bits
32752	Combo-Tip Multi-Tool (32505)	#1 and #2 Double-Sided Combo Bit	2 bits NEW!

Schrader® is a registered trademark of Schrader-Bridgeport International, Inc.

Magnetic Screwdriver Bit Sets

Non-Ratcheting Magnetic Screwdriver with 32-Piece Tamperproof Bit Set

- Sturdy bit and screw holding magnet allows for screws to fit securely in place for easy use.
- Durable PVC black block allows for easy storage of standard 1/4" bits.
- Includes complete tamperproof bit set in block.



Cat. No.	Set Contains	Weight (lbs.)
32510	Bits Included TORX® – T7, T8, T10, T15, T20, T25, T27, T30 & T40 Fraction Hex – 3/32", 7/64", 1/8", 9/64", 5/32", & 3/16" Metric Hex – 2 mm, 2.5 mm, 3 mm, 4 mm, & 5 mm Spanner – 4, 6, 8, & 10 Tri-Wing® – 1, 2, 3 & 4 TORQ-SET® – 6, 8 & 10 1/4" (6 mm) square to 1/4" (6 mm) hex adapter to drive sockets	.71

32510



TORX® is a registered trademark of Acument Intellectual Properties, LLC. TORQ-SET® and Tri-Wing® are registered trademarks of Phillips Screw Co.

32-Piece Bit Sets

- Durable PVC black block allows for easy storage of standard 1/4" bits.
- Block slides over most screwdriver shafts for easy bit access and storage.
- Industrial strength, heat-treated steel bits for long lasting use.
- 1/4" square to 1/4" hex adapter to drive sockets



32526



32525

Cat. No.	Set Contains	Weight (lbs.)
32526	32-Piece Standard Tip Bits Included Hex – 5/64", 3/32", 7/64", 1/8", 9/64", 5/32" & 3/16" Phillips – #0, #1, #2 & #3 Square Recess – #1, #2 & #3 TORX® – T6, T7, T8, T10, T15, T20 & T25 Slotted – 3-4, 5-6, 6-8, 8-10, 10-12 & 12-14 screw sizes Clutch – 5/32" & 3/16"	0.425

Cat. No.	Set Contains	Weight (lbs.)
32525	32-Piece Tamperproof Tip Bits Included TORX® – T7, T8, T10, T15, T20, T25, T27, T30 & T40 Fraction Hex – 5/64", 3/32", 7/64", 1/8", 9/64", 5/32", & 3/16" Metric Hex – 2 mm, 2.5 mm, 3 mm, 4 mm & 5 mm Spanner – 4, 6, 8, and 10 Tri-Wing® – 1, 2, 3 and 4 TORQ-SET® – 6, 8 & 10	0.425

All dimensions are in inches and (millimeters).



www.kleintools.com

See page 310 for additional information on warnings.

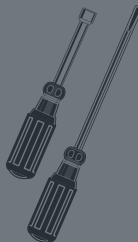

Journeyman™ Screwdrivers

JOURNEYMAN

Features:

Hex-shaped welded bolster offers additional strength between the blade and handle.

Ultra-comfortable tri-lobe handle exceptional control, grip, and balance.

Precision-machined tip for exact fit into the fastener.



Exceptionally hard steel shaft efficiently transfers every bit of torque generated into the tip.

Meets or exceeds applicable ASME / ANSI specifications.

Tip-Ident® quickly identifies the type of screwdriver and tip orientation.

5-Piece Journeyman™ Screwdriver Set

Additional Features:

- General purpose selection of the most frequently used screwdrivers.

Cat. No.	Set Contains	Weight (lbs.)		
JSDS01		1.15		
Cat. No.	Tip Type	Tip Size	Shaft Length	Overall Length
JSD6C06	cabinet	3/16" (5 mm)	6" (152 mm)	10-1/4" (260 mm)
JSD4K08	keystone	1/4" (6 mm)	4" (102 mm)	9" (228 mm)
JSD6K09	keystone	5/16" (8 mm)	6" (152 mm)	11" (279 mm)
JSD4PH1	Phillips	#1	4" (102 mm)	8-1/4" (210 mm)
JSD4PH2	Phillips	#2	4" (102 mm)	9" (228 mm)



JSDS01

7-Piece Journeyman™ Screwdriver Set

Additional Features:

- Accommodates a broad range of standard fastener sizes.

Cat. No.	Set Contains	Weight (lbs.)		
JSDS02		1.65		
Cat. No.	Tip Type	Tip Size	Shaft Length	Overall Length
JSD4C06	cabinet	3/16" (5 mm)	4" (102 mm)	8-1/4" (210 mm)
JSD6C06	cabinet	3/16" (5 mm)	6" (152 mm)	10-1/4" (260 mm)
JSD4K08	keystone	1/4" (6 mm)	4" (102 mm)	9" (228 mm)
JSD6K09	keystone	5/16" (8 mm)	6" (152 mm)	11" (279 mm)
JSD4PH1	Phillips	#1	4" (102 mm)	8-1/4" (210 mm)
JSD4PH2	Phillips	#2	4" (102 mm)	9" (228 mm)
JSD6PH3	Phillips	#3	6" (152 mm)	11" (279 mm)



JSDS02

All dimensions are in inches and (millimeters).



www.kleintools.com

See page 310 for additional information on warnings.

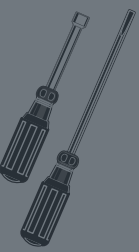

Journeyman™ Screwdrivers

Journeyman™ Screwdrivers – Round Shafts

JOURNEYMAN

Cat. No.	Tip Type	Tip Size	Shaft Length	Overall Length	Weight (lbs.)
JSD4K08	keystone	1/4" (6 mm)	4" (102 mm)	9" (228 mm)	0.25
JSD6K09	keystone	5/16" (8 mm)	6" (152 mm)	11" (279 mm)	0.35
JSD4C06	cabinet	3/16" (5 mm)	4" (102 mm)	8-1/4" (210 mm)	0.15
JSD6C06	cabinet	3/16" (5 mm)	6" (152 mm)	10-1/4" (260 mm)	0.15
JSD4PH1	Phillips	#1	4" (102 mm)	8-1/4" (210 mm)	0.15
JSD4PH2	Phillips	#2	4" (102 mm)	9" (228 mm)	0.25
JSD6PH3	Phillips	#3	6" (152 mm)	11" (279 mm)	0.35



Plastic-Handle Screwdriver Set

Features:

Meets or exceeds applicable ASME / ANSI and MIL specifications.

Smooth Comfordome® handles fit the palm of the hand comfortably.

Nickel-chrome, precision-forged and polished blades with black tips.

Tough amber plastic handle.

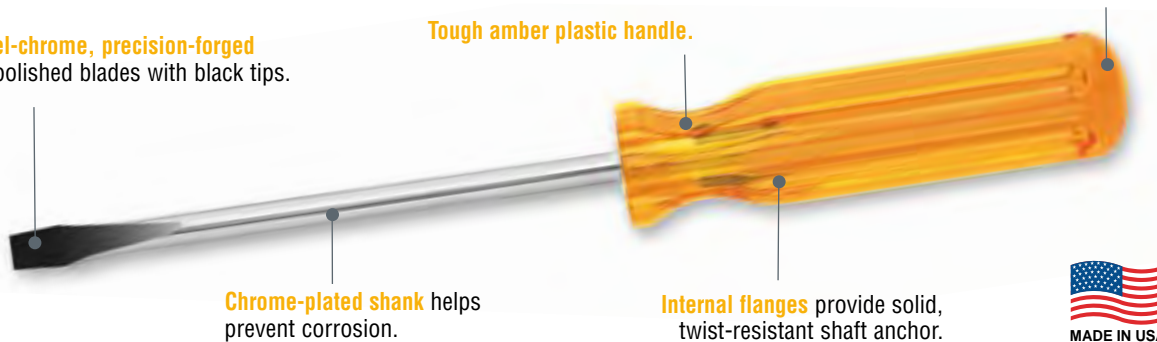

7-Piece Combination Screwdriver Set

Additional Features:

- Set contains two Phillips-tip screwdrivers, two slotted keystone-tip screwdrivers and three popular cabinet-tip screwdrivers.

Cat. No.	Set Contains	Weight (lbs.)
85276		1.10

Cat. No.	Tip Type	Tip Size	Shank Type	Shank Length
BD284	keystone	1/4" (6 mm)	square	4" (102 mm)
BD306	keystone	5/16" (8 mm)	square	6" (152 mm)
A216-3	cabinet	1/8" (3 mm)	round	3" (76 mm)
A216-4	cabinet	1/8" (3 mm)	round	4" (102 mm)
A216-6	cabinet	1/8" (3 mm)	round	6" (152 mm)
BD111	Phillips	#1	round	3" (76 mm)
BD122	Phillips	#2	round	4" (102 mm)



All dimensions are in inches and (millimeters).



www.kleintools.com

See page 310 for additional information on warnings.

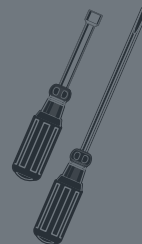

Plastic-Handle Screwdrivers

Pocket-Clip Screwdrivers

Additional Features:

- Specially designed for delicate instrument work.
- Cat. No. A000 does not have a pocket clip.

Cat. No.	Tip Size	Shank Length	Overall Length	Weight (lbs.)
Keystone Tip				
A000	3/32" (2 mm)	1.5" (38 mm)	2-7/8" (73 mm)	.02
A010	3/32" (2 mm)	1-3/8" (35 mm)	3-1/4" (82 mm)	.03
Keystone Tip				
A130-2	1/8" (3 mm)	2" (51 mm)	3-7/8" (98 mm)	.05
A130-3	1/8" (3 mm)	3" (76 mm)	4-7/8" (124 mm)	.04
A116-2	3/32" (2 mm)	2" (51 mm)	4-7/16" (113 mm)	.05
A116-3	3/32" (2 mm)	3" (76 mm)	5-7/16" (138 mm)	.03
A116-4	3/32" (2 mm)	4" (102 mm)	6-7/16" (164 mm)	.03
A131-2	1/8" (3 mm)	2" (51 mm)	4-7/16" (113 mm)	.05
P12	#0	2 1/2" (63 mm)	5" (124 mm)	.05

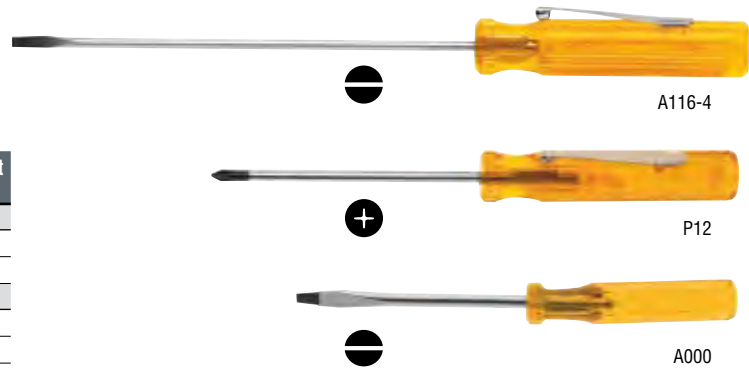

Bull Driver™ Plastic Handle Screwdrivers

Additional Features:

- Oversized handle is 35% larger than comparable screwdriver handles.
- Delivers up to 50% extra power to perform tough jobs with minimum effort.

Cat. No.	Tip Size	Shank Type	Shank Length	Overall Length	Weight (lbs.)
Keystone Tip					
BD284	1/4" (6 mm)	square	4" (102 mm)	8-1/2" (216 mm)	.25
BD286	1/4" (6 mm)	square	6" (152 mm)	10-1/2" (267 mm)	.30
BD306	5/16" (8 mm)	square	6" (152 mm)	11-3/16" (284 mm)	.35
BD308	5/16" (8 mm)	square	8" (203 mm)	13-3/16" (335 mm)	.40
BD310	5/16" (8 mm)	square	10" (254 mm)	15-3/16" (385 mm)	.50
BD410	3/8" (10 mm)	square	10" (254 mm)	15-3/16" (385 mm)	.60
BD412	3/8" (10 mm)	square	12" (305 mm)	17-3/16" (437 mm)	.75
C718	3/8" (10 mm)	square	18" (457 mm)	23-5/16" (592 mm)	.95
BD143	7/32" (2 mm)	round	3" (76 mm)	7-1/2" (190 mm)	.20
BD144	1/4" (6 mm)	round	4" (102 mm)	8-1/2" (216 mm)	.25

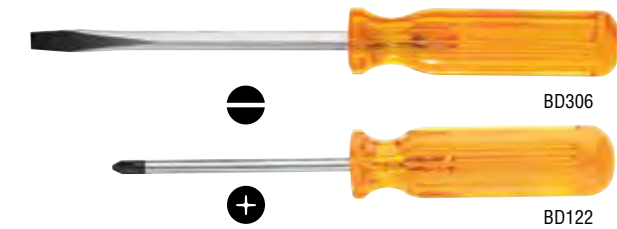

Cat. No.	Tip Size	Shank Type	Shank Length	Overall Length	Weight (lbs.)
Keystone Tip					
BD146	1/4" (6 mm)	round	6" (152 mm)	10-1/2" (267 mm)	.25
BD156	5/16" (8 mm)	round	6" (152 mm)	11-3/16" (284 mm)	.35
BD158	5/16" (8 mm)	round	8" (203 mm)	13-3/16" (335 mm)	.40
BD408	3/8" (10 mm)	round	8" (203 mm)	13-3/16" (335 mm)	.50
BD510	3/8" (10 mm)	round	10" (254 mm)	15-3/16" (386 mm)	.55
70155	1/4" (6 mm)	round	20" (508 mm)	24-1/2" (622 mm)	.45
Phillips Tip					
BD111	#1	round	3" (76 mm)	6-5/8" (168 mm)	.10
BD122	#2	round	4" (102 mm)	8-1/2" (216 mm)	.20
BD133	#3	round	6" (152 mm)	11-3/16" (284 mm)	.35

Profilated Phillips Tip Screwdrivers

Additional Features:

- Precision-machined tips provide a more consistent geometric symmetry to ensure accurate fit and torque without slippage.

Cat. No.	Tip Size	Shank Type	Shank Length	Overall Length	Weight (lbs.)
P18	#1	round	8" (203 mm)	11-1/2" (292 mm)	.15
P28	#2	round	8" (203 mm)	11-5/8" (295 mm)	.20

Cat. No.	Tip Size	Shank Type	Shank Length	Overall Length	Weight (lbs.)
P212	#2	round	12" (305 mm)	15-5/8" (397 mm)	.25
P202	#2	round	20" (508 mm)	24-1/2" (622 mm)	.55



Cabinet-Tip Screwdrivers – Round-Shanks

Additional Features:

- Small-diameter cabinet-tip shank for use in recessed holes or tight places.
- Well-suited for electrical and telecommunications work.

Cat. No.	Tip Size	Shank Length	Overall Length	Weight (lbs.)
A216-2	1/8" (3 mm)	2" (51 mm)	5" (127 mm)	.05
A216-3	1/8" (3 mm)	3" (76 mm)	6" (152 mm)	.05
A216-4	1/8" (3 mm)	4" (102 mm)	7" (178 mm)	.05
A216-6	1/8" (3 mm)	6" (152 mm)	9" (228 mm)	.05
A216-8	1/8" (3 mm)	8" (203 mm)	11" (279 mm)	.05
A216-10	1/8" (3 mm)	10" (254 mm)	13" (330 mm)	.05

Cat. No.	Tip Size	Shank Length	Overall Length	Weight (lbs.)
A316-3	3/16" (5 mm)	3" (76 mm)	6-5/8" (168 mm)	.10
A316-4	3/16" (5 mm)	4" (102 mm)	7-5/8" (194 mm)	.10
A316-6	3/16" (5 mm)	6" (152 mm)	9-5/8" (244 mm)	.10
A316-8	3/16" (5 mm)	8" (203 mm)	11-5/8" (295 mm)	.15
A316-10	3/16" (5 mm)	10" (254 mm)	13-5/8" (346 mm)	.20
70155	1/4" (6 mm)	20" (508 mm)	24-1/2" (622 mm)	.45



All dimensions are in inches and (millimeters).

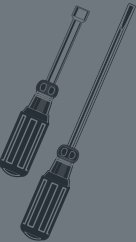

Screw-Holding Screwdrivers

3-Piece Slotted Plastic Handle Screw-Holding Screwdriver Set

- Not designed for torquing or tightening.

Cat. No.	Set Contains	Weight (lbs.)
SK234		.40
Cat. No.	Tip Size	Shank Size
K23	3/16" (5 mm)	3" (76 mm)
K34	1/4" (6 mm)	4" (102 mm)
K46	5/16" (8 mm)	8" (152 mm)



SK234

Slotted Plastic Handle Screw-Holding Screwdrivers

- Positive gripping action holds, starts, and drives slotted screws in awkward, hard-to-reach places.
- Split-blade screw-holding driver wedges into screw slot.
- Not designed for torquing or tightening.

Cat. No.	Tip Size	Shank Length	Overall Length	Weight (lbs.)
K21†	1/16" (15 mm)	3" (76 mm)	5-1/4" (133 mm)	.05
K23	3/16" (5 mm)	3" (76 mm)	5-1/4" (133 mm)	.05
K28	3/16" (5 mm)	8" (203 mm)	10-1/4" (260 mm)	.10
K34‡	1/4" (6 mm)	4" (102 mm)	7-3/4" (197 mm)	.10
K36‡	1/4" (6 mm)	6" (152 mm)	9-3/4" (247 mm)	.15



K36

Cat. No.	Tip Size	Shank Length	Overall Length	Weight (lbs.)
K38‡	1/4" (6 mm)	8" (203 mm)	11-3/4" (298 mm)	.20
K44	5/16" (8 mm)	4" (102 mm)	8-1/4" (209 mm)	.25
K46	5/16" (8 mm)	6" (152 mm)	10-1/4" (260 mm)	.25
K48	5/16" (8 mm)	8" (203 mm)	12-1/4" (311 mm)	.30

† Precision blade for use with small precision screws. Blade thickness of .028" expanding to .045".

‡ Blade thickness of .043" expanding to .085".

Note: K21 and K23 have pocket clips.

Phillips-Tip Screw-Holding Screwdrivers

- Positive gripping action holds and starts Phillips screws in awkward, hard-to-reach places.
- Blade separates to hold the fastener.
- Not designed for torquing or tightening.

Cat. No.	Overall Length	Weight (lbs.)
K14	5" (127 mm) with pocket clip	.05
K16	7" (178 mm)	.05
K19	9" (229 mm)	.05



K16

Offset Screwdrivers

Offset Screwdrivers

- Designed for confined hard-to-reach applications.
- Two tip sizes for added convenience.

Cat. No.	Tip Type	Tip Size	For Screw Nos.	Overall Length	Weight (lbs.)
V01	cabinet	3/16" (5 mm)	2 to 6	3" (76 mm)	.01
V03	cabinet	5/16" (8 mm)	8 to 12	5" (127 mm)	.11
V04	cabinet	3/8" (10 mm)	12 to 16	6" (152 mm)	.25
P340	Phillips	#3 & #4	N/A	6" (152 mm)	.20
V05	cabinet Phillips	1/4" (6 mm) #2	1/4" (6 mm) #2 Phillips	5" (127 mm)	.05

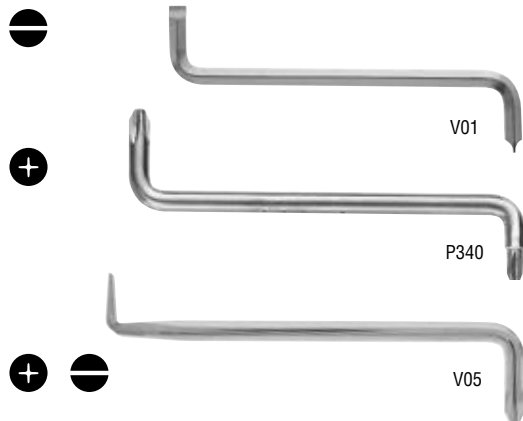

V01

P340

V05

All dimensions are in inches and (millimeters).



www.kleintools.com

See page 310 for additional information on warnings.

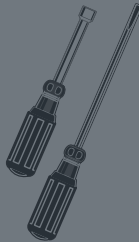

Specialty Driver Set

Reversible Impact-Driver Set

- Rugged, hand-impact driver turns rusted, frozen, or other stubborn screws.
- Can also be used with 3/8" square-drive impact sockets.
- Internal, spring-loaded, helical design transforms the impact of a hammer blow to up to 200 ft.-lbs. of shock torque.
- Easily reverses for tightening or loosening screws.
- Constructed of high-grade alloy steel that has been heat-treated for added strength.
- Reclosable, seal-tight vinyl pouch with hang-up grommet.



70220

Cat. No.	Description	Weight (lbs.)
70220	pouched impact-driver set with 3/8" * (89 mm) -square-drive fitting adapter for 5/16" (8 mm) hex bits, 4 assorted hex screwdriver bits 5/16" (8 mm) and 1/2" (38 mm) regular slotted tip, #2 and #4 Phillips-tip	2.15
Replacement Screwdriver Bits		
70229	replacement set of 5/16" (8 mm)-drive screwdriver bits (5/16" (8 mm) and 1/2" (38 mm) regular slotted tip, #2 and #4 Phillips-tip) packed in reclosable, seal-tight vinyl pouch	.25

Torque Screwdrivers

Torque Screwdriver Set

- Compact, easy to use set includes the Torque Screwdriver, a 6-piece bit set and a ruggedged case with foam inserts for a tight, organized fit.
- Increased usability and readability plus a wider torque range (5-40 in. lbs).
- Tri-lobular design with a textured finish for better grip.
- Lightweight, aluminum frame.
- N.I.S.T. traceable calibration certificate.

Cat. No.	Contains	Weight (lbs.)
57032	Set includes six 3-1/2" (89 mm) power drivers: #1 and #2 Phillips; 3/16" (5 mm) and 1/4" (6 mm) Slotted, and #1 and #2 Square	1.0



57032

Cushion-Grip Nut Driver Sets

Features:



Tip-Ident® quickly identifies nut driver and size.

Internal flanges provide solid, twist-resistant shaft anchor.

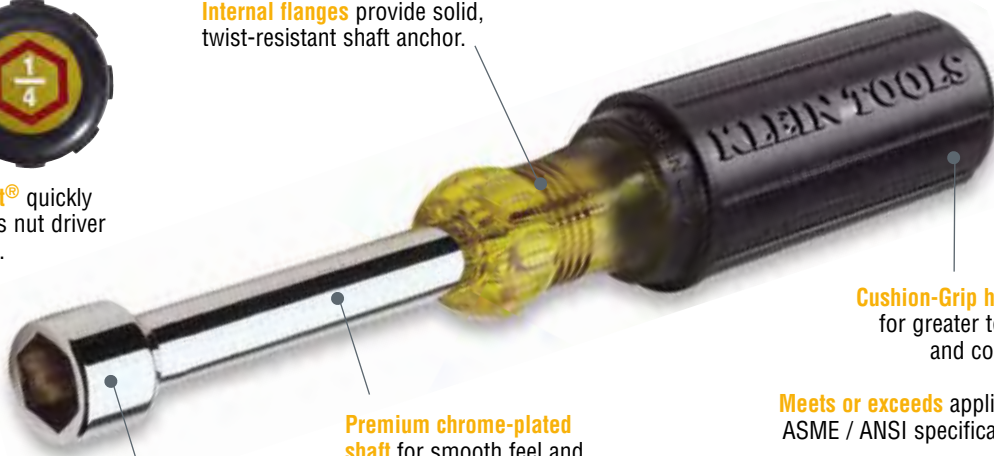

Cushion-Grip handle for greater torque and comfort.

Meets or exceeds applicable ASME / ANSI specifications.

Full hollow shafts facilitate work on stacked circuit boards or other long bolt applications.

Premium chrome-plated shaft for smooth feel and corrosion resistance.

Handle end is also color coded for easy identification.



All dimensions are in inches and (millimeters).



Cushion-Grip Nut Driver Sets

7-Piece Magnetic-Tip Hollow-Shaft* Nut Driver Set – 3" (76 mm) Shafts

- Full hollow-shaft for long bolts or studs.

Cat. No.	Set Contains	Weight (lbs.)
631M		1.50

Cat. No.	Color Code	Hex Size	Overall Length
630-3/16M*	black	3/16"	6-3/4" (171 mm)
630-1/4M	red	1/4"	6-3/4" (171 mm)
630-5/16M	yellow	5/16"	6-3/4" (171 mm)
630-11/32M	green	11/32"	6-3/4" (171 mm)
630-3/8M	blue	3/8"	6-3/4" (171 mm)
630-7/16M	brown	7/16"	7-5/16" (186 mm)
630-1/2M	red	1/2"	7-5/16" (186 mm)

*3/16" magnetic nut driver does not have hollow shaft



631M

7-Piece Nut Driver Set – 3" (76 mm) Shafts

Cat. No.	Set Contains	Weight (lbs.)
631		1.50

Cat. No.	Color Code	Hex Size	Overall Length
630-3/16	black	3/16"	6-3/4" (171 mm)
630-1/4	red	1/4"	6-3/4" (171 mm)
630-5/16	yellow	5/16"	6-3/4" (171 mm)
630-11/32	green	11/32"	6-3/4" (171 mm)
630-3/8	blue	3/8"	6-3/4" (171 mm)
630-7/16	brown	7/16"	7-5/16" (186 mm)
630-1/2	red	1/2"	7-5/16" (186 mm)

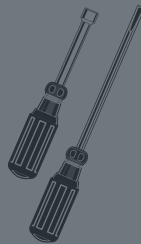

7-Piece Magnetic-Tip Hollow-Shaft* Nut Driver Set – 6" (152 mm) Shafts

- Full hollow shaft for long bolts or studs, with magnetic tip.

Cat. No.	Set Contains	Weight (lbs.)
647M		1.70

Cat. No.	Color Code	Hex Size	Overall Length
646-3/16M*	black	3/16"	9-3/4" (248 mm)
646-1/4M	red	1/4"	9-3/4" (248 mm)
646-5/16M	yellow	5/16"	9-3/4" (248 mm)
646-11/32M	green	11/32"	9-3/4" (248 mm)
646-3/8M	blue	3/8"	9-3/4" (248 mm)
646-7/16M	brown	7/16"	10-5/16" (262 mm)
646-1/2M	red	1/2"	10-5/16" (262 mm)

*3/16" magnetic nut driver does not have hollow shaft



647M



7-Piece Nut Driver Set – 6" (152 mm) Shafts

Cat. No.	Set Contains	Weight (lbs.)
647		1.70

Cat. No.	Color Code	Hex Size	Overall Length
646-3/16	black	3/16"	9-3/4" (248 mm)
646-1/4	red	1/4"	9-3/4" (248 mm)
646-5/16	yellow	5/16"	9-3/4" (248 mm)
646-11/32	green	11/32"	9-3/4" (248 mm)
646-3/8	blue	3/8"	9-3/4" (248 mm)
646-7/16	brown	7/16"	10-5/16" (262 mm)
646-1/2	red	1/2"	10-5/16" (262 mm)

All dimensions are in inches and (millimeters).



www.kleintools.com

See page 310 for additional information on warnings.



Cushion-Grip Nut Driver Sets

4-Piece Nut Driver Set

Additional Features:

- Standard length for most applications.

Cat. No.	Set Contains	Weight (lbs.)		
633		1.30		
Cat. No.	Color Code	Hex Size	Shaft Length	Overall Length
630-1/4	red	1/4"	3" (76 mm)	6-3/4" (171 mm)
630-5/16	yellow	5/16"	3" (76 mm)	6-3/4" (171 mm)
630-3/8	blue	3/8"	3" (76 mm)	6-3/4" (171 mm)
630-9/16	orange	9/16"	4" (102 mm)	9-3/8" (238 mm)



633

2-Piece Stubby Nut Driver Set – 1-1/2" (38 mm) Shafts

Additional Features:

- Full hollow-shaft for long bolt and studs applications.
- Stubby nut drivers allow for work in close quarters.
- Cat. No. 610M features magnetic tips.

Cat. No.	Set Contains	Weight (lbs.)	
610		.20	
Cat. No.	Color Code	Hex Size	Overall Length
610-1/4	red	1/4"	3-1/2" (89 mm)
610-5/16	yellow	5/16"	3-1/2" (89 mm)



610



Cat. No.	Set Contains	Weight (lbs.)	
610M		.20	
Cat. No.	Color Code	Hex Size	Overall Length
610-1/4M	red	1/4"	3-1/2" (89 mm)
610-5/16M	yellow	5/16"	3-1/2" (89 mm)

2-Piece Magnetic-Tip Hollow-Shaft Nut Driver Sets

Additional Features:

- General purpose selection of the most frequently used nut drivers.

Cat. No.	Set Contains	Weight (lbs.)		
630M		.40		
Cat. No.	Color Code	Hex Size	Shaft Length	Overall Length
630-1/4M	red	1/4"	3" (76 mm)	6-3/4" (171 mm)
630-5/16M	yellow	5/16"	3" (76 mm)	6-3/4" (171 mm)



630M

Cat. No.	Set Contains	Weight (lbs.)		
646M		.50		
Cat. No.	Color Code	Hex Size	Shaft Length	Overall Length
646-1/4M	red	1/4"	6" (152 mm)	9-3/4" (248 mm)
646-5/16M	yellow	5/16"	6" (152 mm)	9-3/4" (248 mm)

7-Piece Metric Nut Driver Set – 3" (76 mm) Shafts

Additional Features:

- Standard length for most long bolt and stud applications.

Cat. No.	Set Contains	Weight (lbs.)		
65160		1.50		
Cat. No.	Color Code	Hex Size Metric	Shaft Length	Overall Length
630-5mm	black	5 mm	3" (76 mm)	6-3/4" (171 mm)
630-5.5mm	brown	5.5 mm	3" (76 mm)	6-3/4" (171 mm)
630-6mm	red	6 mm	3" (76 mm)	6-3/4" (171 mm)
630-7mm	orange	7 mm	3" (76 mm)	6-3/4" (171 mm)
630-8mm	yellow	8 mm	3" (76 mm)	6-3/4" (171 mm)
630-9mm	green	9 mm	3" (76 mm)	6-3/4" (171 mm)
630-10mm	blue	10 mm	3" (76 mm)	6-3/4" (171 mm)



65160

All dimensions are in inches and (millimeters).



www.kleintools.com

See page 310 for additional information on warnings.

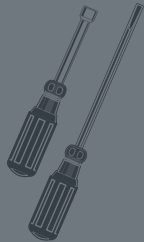

Cushion-Grip Nut Driver Sets

Switch Drive™ Handle Power Nut Driver Set

NEW!

Additional Features:

- Allows for easy alternating between power tool and hand tool on job site.
- Quick-Release mechanism converts power tool accessory to hand tool in a snap.
- Includes Switch Drive™ handle and 3 nut driver sizes.
- Drivers are impact rated.



32701

Cat. No.	Hex Sizes	Nut Driver Length	Overall Length	Weight (lbs.)
32701	1/4", 5/16", 3/8"	2" (51 mm)	7.75" (197 mm)	.70

Refer to the power tool accessories and systems section for more information.

NOTE: Read and follow safety instructions in power tool owner's manual.

Cushion-Grip Nut Drivers

Stubby Nut Drivers – 1-1/2" (38 mm) Shafts

Additional Features:

- Full hollow-shaft for long bolt and studs applications.
- Stubby nut drivers allow for work in close quarters.



610-5/16

Cat. No.	Color Code	Hex Size	Shaft Length	Overall Length	Weight (lbs.)
610-1/4	red	1/4"	1-1/2" (38 mm)	3-1/2" (89 mm)	.10
610-5/16	yellow	5/16"	1-1/2" (38 mm)	3-1/2" (89 mm)	.10

Hollow-Shaft Nut Drivers – 3" (76 mm) Shafts

Additional Features:

- Standard length for most long bolt and stud applications.



630-11mm

Imperial

Cat. No.	Color Code	Hex Size	Shaft Length	Overall Length	Weight (lbs.)
630-3/16	black	3/16"	3" (76 mm)	6-3/4" (171 mm)	.20
630-1/4	red	1/4"	3" (76 mm)	6-3/4" (171 mm)	.20
630-5/16	yellow	5/16"	3" (76 mm)	6-3/4" (171 mm)	.20
630-11/32	green	11/32"	3" (76 mm)	6-3/4" (171 mm)	.20
630-3/8	blue	3/8"	3" (76 mm)	6-3/4" (171 mm)	.20
630-7/16	brown	7/16"	3" (76 mm)	7-5/16" (186 mm)	.25
630-1/2	red	1/2"	3" (76 mm)	7-5/16" (186 mm)	.25
630-9/16	orange	9/16"	4" (102 mm)	9-3/8" (238 mm)	.35
630-5/8	yellow	5/8"	4" (102 mm)	9-3/8" (238 mm)	.35

Metric

Cat. No.	Color Code	Hex Size Metric	Shaft Length	Overall Length	Weight (lbs.)
630-4mm	red	4 mm	3" (76 mm)	6-3/4" (171 mm)	.20
630-4.5mm	yellow	4.5 mm	3" (76 mm)	6-3/4" (171 mm)	.20
630-5mm	black	5 mm	3" (76 mm)	6-3/4" (171 mm)	.20
630-6mm	red	6 mm	3" (76 mm)	6-3/4" (171 mm)	.20
630-7mm	orange	7 mm	3" (76 mm)	6-3/4" (171 mm)	.20
630-8mm	yellow	8 mm	3" (76 mm)	6-3/4" (171 mm)	.20
630-10mm	blue	10 mm	3" (76 mm)	6-3/4" (171 mm)	.20
630-11mm	brown	11 mm	3" (76 mm)	7-5/16" (186 mm)	.20

Refer to the insulated section for insulated nut drivers.

All dimensions are in inches and (millimeters).



www.kleintools.com

See page 310 for additional information on warnings.

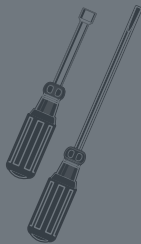

Cushion-Grip Nut Drivers Sets

Hollow-Shaft Nut Drivers – 6" (152 mm) Shafts

Additional Features:

- Reaches into deep recesses.
- Fits over extra-long bolts and studs.

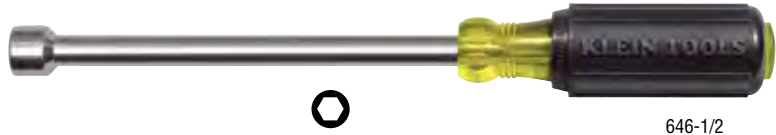

646-1/2

Cat. No.	Color Code	Hex Size	Shaft Length	Overall Length	Weight (lbs.)
646-3/16	black	3/16"	6" (152 mm)	9-3/4" (248 mm)	.25
646-1/4	red	1/4"	6" (152 mm)	9-3/4" (248 mm)	.25
646-5/16	yellow	5/16"	6" (152 mm)	9-3/4" (248 mm)	.25
646-11/32	green	11/32"	6" (152 mm)	9-3/4" (248 mm)	.25
646-3/8	blue	3/8"	6" (152 mm)	9-3/4" (248 mm)	.30

Cat. No.	Color Code	Hex Size	Shaft Length	Overall Length	Weight (lbs.)
646-7/16	brown	7/16"	6" (152 mm)	10-5/16" (262 mm)	.35
646-1/2	red	1/2"	6" (152 mm)	10-5/16" (262 mm)	.35
646-9/16	orange	9/16"	6" (152 mm)	11-3/8" (289 mm)	.40
646-5/8	yellow	5/8"	6" (152 mm)	11-3/8" (289 mm)	.40

Magnetic-Tip Hollow-Shaft* Nut Drivers

Additional Feature:

- Exclusive hollow shaft* design with Rare Earth magnetic tip features unobstructed pass-through, even on long bolts.

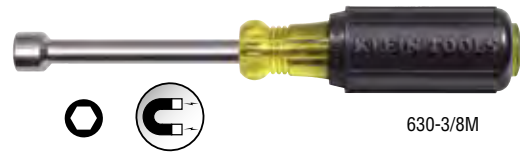

630-3/8M

Cat. No.	Color Code	Hex Size	Shaft Length	Overall Length	Weight (lbs.)
610-1/4M	red	1/4"	3" (76 mm)	1-1/2" (89 mm)	.10
610-5/16M	yellow	5/16"	3" (76 mm)	1-1/2" (89 mm)	.10
610-3/8M	blue	3/8"	3" (76 mm)	1-1/2" (89 mm)	.10
630-3/16M*	black	3/16"	3" (76 mm)	6-3/4" (171 mm)	.20
630-1/4M	red	1/4"	3" (76 mm)	6-3/4" (171 mm)	.20
630-5/16M	yellow	5/16"	3" (76 mm)	6-3/4" (171 mm)	.20
630-11/32M	green	11/32"	3" (76 mm)	6-3/4" (171 mm)	.20
630-3/8M	blue	3/8"	3" (76 mm)	6-3/4" (171 mm)	.20
630-7/16M	brown	7/16"	3" (76 mm)	7-5/16" (186 mm)	.25

Cat. No.	Color Code	Hex Size	Shaft Length	Overall Length	Weight (lbs.)
646-3/16M*	black	3/16"	6" (152 mm)	9-3/4" (248 mm)	.25
646-1/4M	red	1/4"	6" (152 mm)	9-3/4" (248 mm)	.25
646-5/16M	yellow	5/16"	6" (152 mm)	9-3/4" (248 mm)	.25
646-11/32M	green	11/32"	6" (152 mm)	9-3/4" (248 mm)	.25
646-3/8M	blue	3/8"	6" (152 mm)	9-3/4" (248mm)	.30
646-7/16M	brown	7/16"	6" (152 mm)	10-5/16" (262 mm)	.35
646-1/2M	red	1/2"	6" (152 mm)	10-5/16" (262 mm)	.35
618-1/4M	red	1/4"	18" (457 mm)	21-3/4" (552 mm)	.50
618-5/16M	yellow	5/16"	18" (457 mm)	21-3/4" (552 mm)	.50

*3/16" magnetic nut driver does not have a hollow shaft.

Drive-A-Matic Nut Driver



632

Additional Features:

- Automatically fits 15 different nut and screw sizes.
- Hex head adjusts to the proper size as you turn it.
- Will drive or loosen hex nuts from 1/4" (6 mm) to 7/16" (11 mm), hex-head screws from No. 6 to 1/4" (6 mm), and socket-head cap screws from No. 8 to 5/16" (8 mm).

Cat. No.	Overall Length	Weight (lbs.)
632	7" (178 mm) when open, 6-3/4" (171 mm) when closed	.35

Coated Hollow-Shaft Nut Drivers



640-1/2

Additional Features:

- Entire shaft plastic coated for circuit protection only. NOT INSULATED.
- Special plastic coating resists cutting, cracking and chipping.
- Thin coating permits use in confined areas.

Cat. No.	Color Code	Hex Size	Shaft Length	Overall Length	Weight (lbs.)
640-3/16	black	3/16"	3" (76 mm)	6-3/4" (171 mm)	.25
640-1/4	red	1/4"	3" (76 mm)	6-3/4" (171 mm)	.25
640-5/16	yellow	5/16"	3" (76 mm)	6-3/4" (171 mm)	.25
640-3/8	blue	3/8"	3" (76 mm)	6-3/4" (171 mm)	.25
640-7/16	brown	7/16"	3" (76 mm)	7-5/16" (186 mm)	.30
640-1/2	red	1/2"	3" (76 mm)	7-5/16" (186 mm)	.25
640-9/16	orange	9/16"	4" (102 mm)	9-3/8" (238 mm)	.40
640-5/8	yellow	5/8"	4" (102 mm)	9-3/8" (238 mm)	.40

⚠️WARNING: NOT insulated. Coating is intended for protection of circuits only.

All dimensions are in inches and (millimeters).



www.kleintools.com

See page 310 for additional information on warnings.

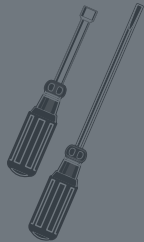

Plastic-Handle, Hollow-Shaft Nut Driver Sets

Features:

Meets or exceeds applicable ASME / ANSI specifications.

Smooth Comfordome® handles fit the palm of the hand comfortably.

Chrome-plated shaft helps prevent corrosion.

Hollow shafts facilitate work on stacked circuit boards or other long bolt applications.

Internal flanges provide solid, twist-resistant shaft anchor.

Handles are color-coded for easy identification.



7-Piece Nut Driver Set – 3" (76 mm) Shafts

Additional Features:

- Set contains seven hollow-shaft nut drivers in the most popular hex sizes.
- Convenient vinyl pouch hangs up or rolls up.

Cat. No.	Set Contains				Weight (lbs.)
K7					1.15
Cat. No.	Handle Color	Hex Size	Shaft Length	Overall Length	
S6	black	3/16"	3" (76 mm)	6-5/8" (168 mm)	
S8	red	1/4"	3" (76 mm)	6-5/8" (168 mm)	
S10	amber	5/16"	3" (76 mm)	6-5/8" (168 mm)	
S11	green	11/32"	3" (76 mm)	6-5/8" (168 mm)	
S12	blue	3/8"	3" (76 mm)	6-5/8" (168 mm)	
S14	brown	7/16"	3" (76 mm)	7" (178 mm)	
S16	red	1/2"	3" (76 mm)	7" (178 mm)	



K7

7-Piece Nut Driver Set – 6" (152 mm) Shafts

Additional Feature:

- Contains seven 6"-shaft nut drivers that reach into deep recesses.

Cat. No.	Set Contains				Weight (lbs.)
89904					1.15
Cat. No.	Handle Color	Hex Size	Shaft Length	Overall Length	
S66	black	3/16"	6" (152 mm)	9-5/8" (244 mm)	
S86	red	1/4"	6" (152 mm)	9-5/8" (244 mm)	
S106	amber	5/16"	6" (152 mm)	9-5/8" (244 mm)	
S116	green	11/32"	6" (152 mm)	9-5/8" (244 mm)	
S126	blue	3/8"	6" (152 mm)	9-5/8" (244 mm)	
S146	brown	7/16"	6" (152 mm)	10" (254 mm)	
S166	red	1/2"	6" (152 mm)	10" (254 mm)	



89904

All dimensions are in inches and (millimeters).



www.kleintools.com

See page 310 for additional information on warnings.



Plastic-Handle, Hollow-Shaft Nut Driver Sets

10-Piece Metric Nut Driver Set With Stand – 3" (76 mm) Shafts

Additional Features:

- White enameled metal stand holds all ten 3"-shaft metric nut drivers.
- Identification label makes individual size selection easy.

Cat. No.	Set Contains	Weight (lbs.)	
70200		1.85	
Cat. No.	Hex Size	Shaft Length	Overall Length
70204	4 mm	3" (76 mm)	6-5/8" (168 mm)
70245	4.5 mm	3" (76 mm)	6-5/8" (168 mm)
70205	5 mm	3" (76 mm)	6-5/8" (168 mm)
70255	5.5 mm	3" (76 mm)	6-5/8" (168 mm)
70206	6 mm	3" (76 mm)	6-5/8" (168 mm)
70207	7 mm	3" (76 mm)	6-5/8" (168 mm)
70208	8 mm	3" (76 mm)	6-5/8" (168 mm)
70209	9 mm	3" (76 mm)	6-5/8" (168 mm)
70210	10 mm	3" (76 mm)	7" (178 mm)
70211	11 mm	3" (76 mm)	7" (178 mm)



70200

Plastic-Handle Hollow Shaft Nut Drivers

Stubby Nut Drivers – 1-1/2" (38 mm) Shafts

Additional Feature:

- For work in close quarters.

Cat. No.	Handle Color	Hex Size	Shaft Length	Overall Length	Weight (lbs.)
SS8	red	1/4"	1-1/2" (38 mm)	3-3/4" (95 mm)	.15
SS10	amber	5/16"	1-1/2" (38 mm)	3-3/4" (95 mm)	.15
SS12	blue	3/8"	1-1/2" (38 mm)	3-3/4" (95 mm)	.15



SS10

Hollow-Shaft Nut Drivers – 3" (76 mm) & 4" (102 mm) Shafts



S10

Additional Features:

- Standard length works for most applications.
- Fits over long bolts and studs.

Cat. No.	Handle Color	Hex Size	Shaft Length	Overall Length	Weight (lbs.)
S5	amber	5/32"	3" (76 mm)	6-1/2" (165 mm)	.10
S6	black	3/16"	3" (76 mm)	6-5/8" (168 mm)	.10
S7	brown	7/32"	3" (76 mm)	6-5/8" (168 mm)	.10
S8	red	1/4"	3" (76 mm)	6-5/8" (168 mm)	.15
S9	orange	9/32"	3" (76 mm)	6-5/8" (168 mm)	.15
S10	amber	5/16"	3" (76 mm)	6-5/8" (168 mm)	.15
S11	green	11/32"	3" (76 mm)	6-5/8" (168 mm)	.15
S12	blue	3/8"	3" (76 mm)	6-5/8" (168 mm)	.15
S14	brown	7/16"	3" (76 mm)	7" (178 mm)	.20
S16	red	1/2"	3" (76 mm)	7" (178 mm)	.20
S18	red	9/16"	4" (102 mm)	8-1/2" (216 mm)	.30
S20	red	5/8"	4" (102 mm)	8-1/2" (216 mm)	.30

Metric Nut Drivers – 3" (76 mm) Shafts



70209

Additional Features:

- Standard length works for most applications.
- Fits over long bolts and studs.

Cat. No.	Handle Color	Hex Size	Shaft Length	Overall Length	Weight (lbs.)
70204	black	4 mm	3" (76 mm)	6-5/8" (168 mm)	.10
70245	black	4.5 mm	3" (76 mm)	6-5/8" (168 mm)	.10
70205	black	5 mm	3" (76 mm)	6-5/8" (168 mm)	.15
70255	black	5.5 mm	3" (76 mm)	6-5/8" (168 mm)	.15
70206	black	6 mm	3" (76 mm)	6-5/8" (168 mm)	.15
70207	black	7 mm	3" (76 mm)	6-5/8" (168 mm)	.15
70208	black	8 mm	3" (76 mm)	6-5/8" (168 mm)	.15
70209	black	9 mm	3" (76 mm)	6-5/8" (168 mm)	.15
70210	black	10 mm	3" (76 mm)	7" (178 mm)	.15
70211	black	11 mm	3" (76 mm)	7" (178 mm)	.20

All dimensions are in inches and (millimeters).



www.kleintools.com

See page 310 for additional information on warnings.

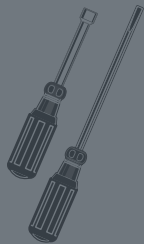

Plastic-Handle, Nut Drivers

Nut Drivers – 6" (152 mm) Shafts



Additional Features:

- Reaches into deep recesses.
- Fits over extra-long bolts and studs.

S86

Cat. No.	Handle Color	Hex Size	Shaft Length	Overall Length	Weight (lbs.)
S66	black	3/16"	6" (152 mm)	9-5/8" (244 mm)	.15
S86	red	1/4"	6" (152 mm)	9-5/8" (244 mm)	.15
S106	amber	5/16"	6" (152 mm)	9-5/8" (244 mm)	.15
S116	green	11/32"	6" (152 mm)	9-5/8" (244 mm)	.15
S126	blue	3/8"	6" (152 mm)	9-5/8" (244 mm)	.15
S146	brown	7/16"	6" (152 mm)	10" (254 mm)	.20

Magnetic Nut Drivers – Solid Shafts



Additional Feature:

- Powerful nut-holding magnet built into solid shaft.

S106M

Cat. No.	Handle Color	Hex Size	Shaft Length	Overall Length	Weight (lbs.)
S8M	red	1/4"	3" (76 mm)	6-5/8" (168 mm)	.15
S10M	amber	5/16"	3" (76 mm)	6-5/8" (168 mm)	.15
S86M	red	1/4"	6" (152 mm)	9-5/8" (244 mm)	.15
S106M	amber	5/16"	6" (152 mm)	9-5/8" (244 mm)	.15
S126M	blue	3/8"	6" (152 mm)	9-5/8" (244 mm)	.15
S818M	red	1/4"	18" (457 mm)	21-5/8" (549 mm)	.25
S1018M	amber	5/16"	18" (457 mm)	21-5/8" (549 mm)	.25

Super-Long Nut Drivers – 18" (457 mm) Shafts



Additional Features:

- Heavy-duty, long-reach nut drivers.
- Ideal for reaching into walls and other hard-to-reach places where added length is necessary.
- Available in magnetic and non-magnetic tips.

S1018

Cat. No.	Handle Color	Type	Hex Size	Shaft Length	Overall Length	Weight (lbs.)
S818	red	standard	1/4"	18" (457 mm)	21-5/8" (549 mm)	.25
S1018	amber	standard	5/16"	18" (457 mm)	21-5/8" (549 mm)	.25
S818M	red	magnetic	1/4"	18" (457 mm)	21-5/8" (549 mm)	.25
S1018M	amber	magnetic	5/16"	18" (457 mm)	21-5/8" (549 mm)	.25

Tapping Tools and Awls

Cushion-Grip Multi-Bit Tap Tool Driver **NEW!**

- Increases job speed by combining taps and drivers in one tool
- Six common tap sizes (6-32, 8-32, 10-32, 10-24, 12-24, 1/4-20)
- Each tap size rethreads to next larger size if threads are stripped.



32517

Cat. No.	Shaft Length	Overall Length	Weight (lbs.)
32517	4" (100 mm)	7-3/4" (200 mm)	0.50

Replacement Tap	Weight (lbs.)
32518 Tap sizes 6-32, 8-32, 10-32, 10-24, 12-24, 1/4-20	.05



Cushion-Grip Triple Taps and 6-in-1 Tap Tool

- Quickly forms new threads, re-forms burred threads, and cleans out plaster obstructions.
- Each tap size rethreads to next larger size if threads are stripped.



626

Cat. No.	Tap Sizes	Overall Length	Weight (lbs.)
623-20	Triple Tap 10-24, 12-24, 1/4-20	7-3/4" (197 mm)	.25
623-24	Triple Tap 6-32, 8-32, 10-24	7-3/4" (197 mm)	.25
626	6-in-1 Tap 6-32, 8-32, 10-32, 10-24, 12-24, 1/4-20	7-3/4" (197 mm)	.25

Replacement Taps	Weight (lbs.)
628-20 10-24, 12-24, 1/4-20	replacement for 623-20, 626
626-24 6-32, 8-32, 10-24	replacement for 623-24
626-32 6-32, 8-32, 10-32	replacement for 623-32, 626

Drill Tap Set **NEW!**

- For aluminum, brass, copper, plastic, and mild steel.
- 1/4" hex for easier application with quick connect.
- Set of six tap sizes plus two extra of the smallest taps.
- For use on up to 10 gauge metal.
- Replacement taps are available.

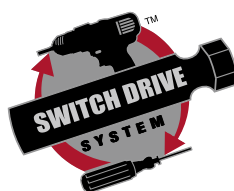

Cat. No.	Tap Sizes Included	Weight (lbs.)
32217	6-32 (2), 8-32 (2) 10-24, 10-32, 12-24, 1/4-20	1.0

NOTE: Read and follow safety instructions in power tool owner's manual. 32217

All dimensions are in inches and (millimeters).



www.kleintools.com

See page 310 for additional information on warnings.

Tapping Tools and Awls

6-in-1 Tapping Tool



- Quickly forms new threads, re-forms burred threads, and cleans out plaster obstructions.
- Each tap size rethreads to next larger size if threads are stripped.
- Two high-carbon steel taps are secured in reversible holder.

627-20

Cat. No.	Tap Sizes	Overall Length	Weight (lbs.)
627-20	6-32, 8-32, 10-32, 10-24, 12-24, 1/4-20	7-5/8" (194 mm)	0.35

Replacement Taps

626-32	10-32, 8-32, 6-32
628-20	10-24, 12-24, 1/4-20

Triple Taps



- Quickly forms new threads, re-forms burred threads, and cleans out plaster obstructions.
- Each tap size rethreads to next larger size if threads are stripped.

625-24

Cat. No.	Tap Sizes	Color Code	Overall Length	Weight (lbs.)
625-24	6-32, 8-32, 10-24	blue	7-1/8" (181 mm)	0.20
625-32	6-32, 8-32, 10-32	orange	7-1/8" (181 mm)	0.20

Replacement Taps

626-24	for Cat. No. 625-24
626-32	for Cat. No. 625-32

Cushion-Grip Scratch Awl

- Professional, heavy-duty, hard-pointed awl.
- Scribes metal, starts screw holes, performs a variety of piercing and punching jobs.
- Rigid, chrome-plated, heat-treated, tempered-steel shank has full reinforcing bolster at handle for extra strength and impact reinforcement.
- Cat. No. 650DD has plated metal strike cap to protect handle from hammer blows and is engineered, manufactured and tested for prying, chiseling and punching.

NEW!



650DD



Cat. No. 650 only

Cat. No.	Blade Length	Overall Length	Weight (lbs.)
650	3-1/2" (89 mm)	7-7/8" (200 mm)	.25
650DD	3-1/2" (89 mm)	7-7/8" (200 mm)	.30 NEW!

Steel Scratch Awl

- One-piece forged-steel blade and bolstered shank.
- Heat treated for long life.
- Well-balanced for top efficiency during use.
- Black finish for rust resistance.



66385

Cat. No.	Blade Length	Overall Length	Weight (lbs.)
66385	3-1/2" (89 mm)	7" (178 mm)	.30

Cushion-Grip Spring Tools

Spring Tool

- Installs or removes small-diameter coil springs on motors, brake shoes, headlights, relays, installing recessed can lighting, solenoids, and hundreds of other applications.
- Great for rod and leaf springs.
- Unique C-tip prevents spring slippage.



ST4

Cat. No.	Shank Length	Overall Length	Weight (lbs.)
ST4	4" (102 mm)	7-3/4" (197mm)	.17
ST6	6" (152 mm)	9-3/4" (248 mm)	.19

2-Piece Recessed Can Light Tool Set

- Contains the two tools needed for finishing can light installations in record time.
- Long reach, spring tool (Cat. No. ST6) makes attaching difficult springs easy.
- Compact, stubby nut driver (Cat. No. 610-1/4) even fits in smaller cans to tighten hard to reach ceiling height adjustment screws.



65020

Cat. No.	Set Contains	Weight (lbs.)
65020		.36

Cat. No.	Description	Shank Length	Overall Length
ST6	6" (152 mm) spring tool	6" (152 mm)	9-3/4" (248 mm)
610-1/4	1/4" (6 mm) stubby nut driver	1-1/2" (38 mm)	3-1/2" (89 mm)

All dimensions are in inches and (millimeters).



www.kleintools.com

See page 310 for additional information on warnings.

Screwdrivers, Nut Drivers & Accessories

Offering a variety of tip types, hex sizes, shaft lengths, and handle designs, Klein has the screwdrivers and nut drivers professionals demand to get the job done with comfort and ease of use.

For Professionals...
Since 1857™

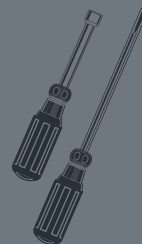

Introduction – Screwdrivers, Nut Drivers & Accessories

Klein screwdrivers give professionals extra-quality features that have made the Klein name famous for hand tools – features that assure greater convenience, comfort and efficiency in use, plus exceptional strength and durability.

All Klein drivers are made of the highest quality tempered steel, carefully heat-treated for maximum strength. Shafts have integral flanges that provide an extra-strong, torque-proof anchor in the handle. Strong, durable black tips are forged and precision ground with square edges to fit screw openings securely. They resist slippage and provide positive turning action.

Cushion-Grip screwdrivers feature super-comfortable, sure-grip handles on top-quality blades for the professional. All Klein screwdrivers meet or exceed applicable ANSI and MIL specifications.

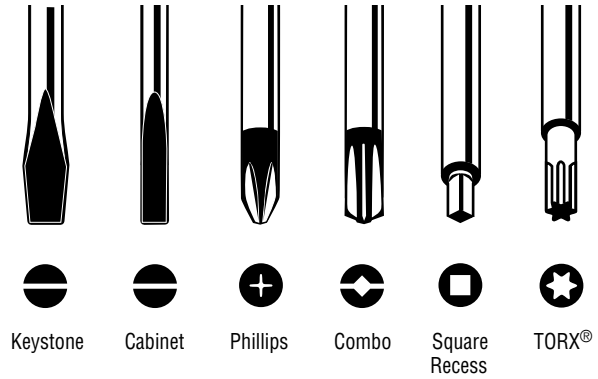

Using Screwdrivers and Nut Drivers

The size of the screw or nut and the type of opening it has determines which driver to use. Here are a few tips on how to use a driver that can be of benefit, because screwdrivers are the most often misused and abused hand tools of all.

- 1. Never use a driver to do another tool's job.**
Using a driver as a pry bar, scraper, or a chisel can ruin the tool, spoil the work and cause injury.
- 2. Never push a driver beyond its capacity.**
Make a pilot hole for the screw for easier driving. Use square-shank drivers for heavy work.
- 3. Never expose a driver to excessive heat.**
Direct flame can draw the temper from the metal, weakening and possibly warping it, making it unsafe and inefficient to use.

- 4. Never use a driver at an angle to the screw.**
Always keep the shank perpendicular to the screw head. Driving at an angle or using a point that is too small can spoil the screw or slip and damage the work.
- 5. Never depend on a driver's handle or covered blade to insulate you from electricity.** Plastic and Cushion-Grip handles are intended only to provide a firm, comfortable grip. Insulated blades are intended only as a protective measure against shorting out components. Only use insulated tools that are marked with the official international 1000-volt rating symbol if there is any chance that the tool will make contact with an energized source.
- 6. Discard damaged or worn drivers.**

TORX® is a registered trademark of Acument Intellectual Properties, LLC.

Cushion-Grip Screwdriver Sets

Features:

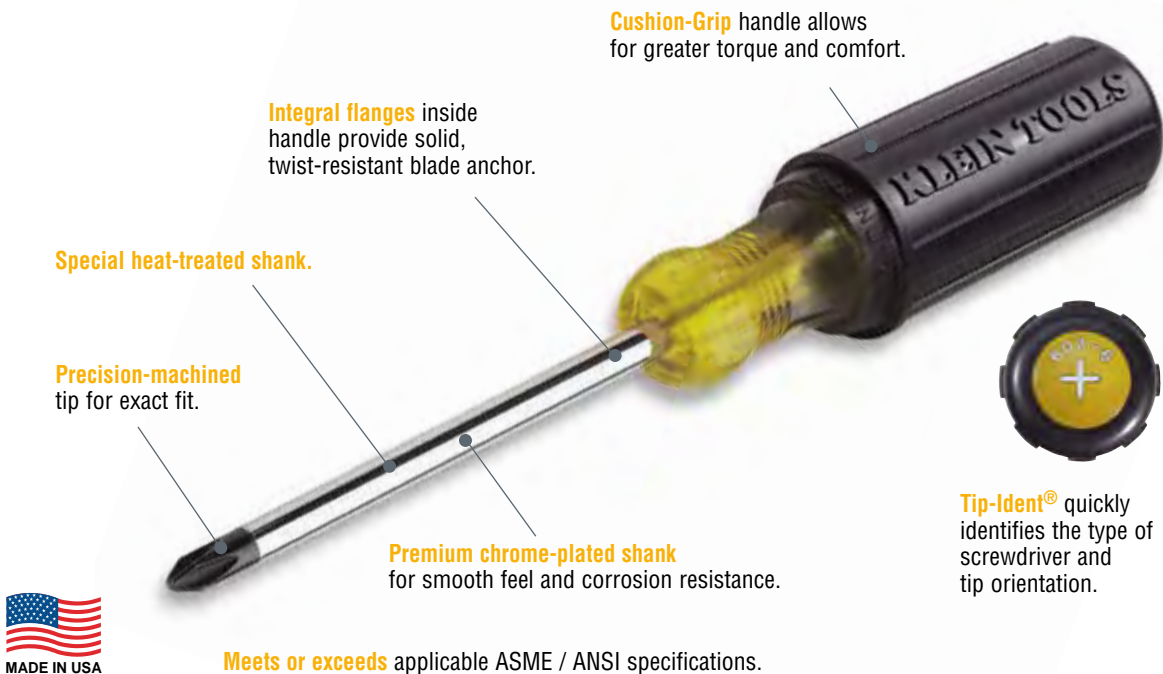

All dimensions are in inches and (millimeters).



www.kleintools.com

See page 310 for additional information on warnings.

Cushion-Grip Screwdriver Sets

8-Piece Screwdriver Set

Additional Features:

- General purpose selection of the most frequently used screwdrivers.
- Includes two cabinet-tip, two keystone-tip, four Phillips-tip styles.

Cat. No.	Set Contains	Weight (lbs.)			
85078		1.65			
Cat. No.	Tip Type	Tip Size	Shank Type	Shank Length	Overall Length
600-4	keystone*	1/4" (6 mm)	square	4" (102 mm)	8-11/32" (212 mm)
602-6	keystone*	5/16" (8 mm)	round	6" (152 mm)	10-15/16" (278 mm)
600-1	cabinet	5/16" (8 mm)	round	1-1/2" (38 mm)	3-7/16" (87 mm)
601-3	cabinet	3/16" (5 mm)	round	3" (76 mm)	6-3/4" (171 mm)
603-3	Phillips	#1	round	3" (76 mm)	6-3/4" (171 mm)
603-1	Phillips	#2	round	1-1/2" (38 mm)	3-7/16" (87 mm)
603-4	Phillips	#2	round	4" (102 mm)	8-5/16" (211 mm)
603-6	Phillips	#3	round	6" (152 mm)	11" (279 mm)

* Heavy-duty models



85078

7-Piece Screwdriver Set

Additional Features:

- General-purpose selection of the most frequently used screwdrivers.
- Includes three cabinet-tip, two Phillips-tip and two keystone-tip styles.

Cat. No.	Set Contains	Weight (lbs.)			
85076		1.50			
Cat. No.	Tip Type	Tip Size	Shank Type	Shank Length	Overall Length
600-4	keystone*	1/4" (6 mm)	square	4" (102 mm)	8-11/32" (212 mm)
602-6	keystone*	5/16" (8 mm)	round	6" (152 mm)	10-15/16" (278 mm)
601-3	cabinet	3/16" (5 mm)	round	3" (76 mm)	6-3/4" (171 mm)
601-6	cabinet	3/16" (5 mm)	round	6" (152 mm)	9-3/4" (248 mm)
605-4	cabinet*	1/4" (6 mm)	round	4" (102 mm)	8-11/32" (212 mm)
603-3	Phillips	#1	round	3" (76 mm)	6-3/4" (171 mm)
603-4	Phillips	#2	round	4" (102 mm)	8-5/16" (211 mm)

* Heavy-duty models

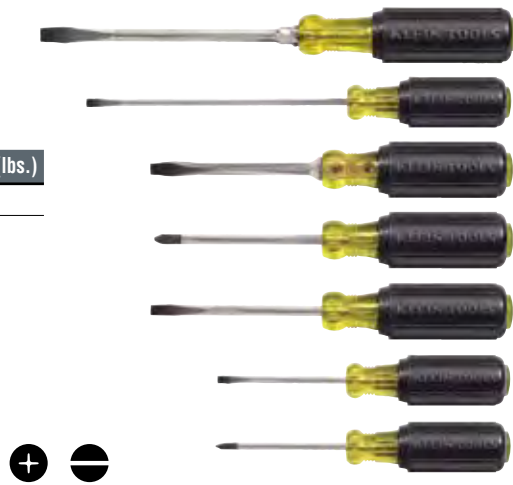

85076

7-Piece Multiple-Application Screwdriver Set

Additional Features:

- Specialty set for a wide variety of applications.
- Includes two cabinet-tip, one Phillips-tip, two keystone-tip, one rotary and one screw-holding screwdriver.

Cat. No.	Set Contains	Weight (lbs.)			
85077		1.65			
Cat. No.	Tip Type	Tip Size	Shank Type	Shank Length	Overall Length
600-4	keystone*	1/4" (6 mm)	square	4" (102 mm)	8-11/32" (212 mm)
602-6	keystone*	5/16" (8 mm)	round	6" (152 mm)	10-15/16" (278 mm)
601-6	cabinet	3/16" (5 mm)	round	6" (152 mm)	9-3/4" (248 mm)
605-6	cabinet*	1/4" (6 mm)	round	6" (152 mm)	10-11/32" (263 mm)
670-6	cabinet Rapi-Drive™	3/16" (5 mm)	round	6" (152 mm)	9-3/4" (248 mm)
K36	slotted screw-holding	N/A	round	6" (152 mm)	9-3/4" (248 mm)
603-4	Phillips	#2	round	4" (102 mm)	8-5/16" (211 mm)

* Heavy-duty models



85077

All dimensions are in inches and (millimeters).



www.kleintools.com

See page 310 for additional information on warnings.

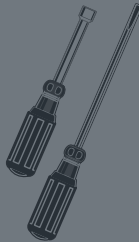

Cushion-Grip Screwdriver Sets

6-Piece Screwdriver Set

Additional Features:

- General-purpose selection of the most frequently used screwdrivers.
- Includes one cabinet-tip, two keystone-tip and three Phillips-tip styles.

Cat. No.	Set Contains	Weight (lbs.)			
85074		1.50			
Cat. No.	Tip Type	Tip Size	Shank Type	Shank Length	Overall Length
600-4	keystone*	1/4" (6 mm)	round	4" (102 mm)	8-11/32" (212 mm)
600-6	keystone*	1/4" (6 mm)	square	6" (152 mm)	10-15/16" (278 mm)
601-3	cabinet	3/16" (5 mm)	round	3" (76 mm)	6-3/4" (171 mm)
603-3	Phillips	#1	round	3" (76 mm)	6-3/4" (171 mm)
603-4	Phillips	#2	round	4" (102 mm)	8-5/16" (211 mm)
603-6	Phillips	#3	round	6" (152 mm)	11" (279 mm)

* Heavy-duty models



85074

5-Piece Screwdriver Set

Additional Features:

- General-purpose selection of the most frequently used screwdrivers.
- Includes two cabinet-tip, one Phillips-tip and two keystone-tip screwdrivers.

Cat. No.	Set Contains	Weight (lbs.)			
85075		1.30			
Cat. No.	Tip Type	Tip Size	Shank Type	Shank Length	Overall Length
602-6	keystone*	5/16" (8 mm)	round	6" (152 mm)	10-15/16" (278 mm)
600-4	keystone*	1/4" (6 mm)	square	4" (102 mm)	8-11/32" (212 mm)
601-6	cabinet	3/16" (5 mm)	round	6" (152 mm)	9-3/4" (248 mm)
605-6	cabinet*	1/4" (6 mm)	round	6" (152 mm)	10-11/32" (263 mm)
603-4	Phillips	#2	round	4" (102 mm)	8-5/16" (211 mm)

* Heavy-duty models



85075

4-Piece Screwdriver Set

Additional Features:

- The screwdrivers professionals carry most often.
- Includes one Phillips-tip, two keystone-tip, one cabinet-tip screwdrivers.

Cat. No.	Set Contains	Weight (lbs.)			
85105		1.50			
Cat. No.	Tip Type	Tip Size	Shank Type	Shank Length	Overall Length
600-6	square	1/4" (6 mm)	square	6" (152 mm)	10-15/16" (278 mm)
600-4	keystone*	1/4" (6 mm)	square	4" (102 mm)	8-11/32" (212 mm)
601-6	cabinet	3/16" (5 mm)	round	6" (152 mm)	9-3/4" (248 mm)
603-4	Phillips	#2	round	4" (102 mm)	8-5/16" (211 mm)

* Heavy-duty models



85105

All dimensions are in inches and (millimeters).

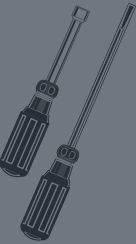

Cushion-Grip Screwdriver Sets

5-Piece Electronics Screwdriver Set

Additional Features

- Rotating cap for optimum and precise control when working on small equipment.
- Includes professional custom carrying case.

Cat. No.	Set Contains				Weight
85614					.80
Cat. No.	Tip Type	Tip Size	Shank Length	Overall Length	
614-2	cabinet	1/16" (2 mm)	2" (51 mm)	5-1/2" (140 mm)	
614-3	cabinet	3/32" (1 mm)	3" (76 mm)	6-1/2" (165 mm)	
614-4	cabinet	1/8" (3 mm)	4" (102 mm)	7-1/2" (191 mm)	
614-6	cabinet	1/8" (3 mm)	6" (152 mm)	9-1/2" (241 mm)	
613-3	Phillips	#0	3" (76 mm)	6-1/2" (165 mm)	



85614

4-Piece Miniature Screwdriver Set

Additional Feature:

- Precision tips for exact fit and rigorous applications.

Cat. No.	Set Contains				Weight (lbs.)
85484					.14
Cat. No.	Tip Type	Tip Size	Shank Length	Overall Length	
604-3	Phillips	#0	3" (76 mm)	5-3/4" (146 mm)	
606-2	keystone	1/16" (1.6 mm)	2" (51 mm)	4-3/4" (121 mm)	
607-3	cabinet	3/32" (1 mm)	3" (76 mm)	5-3/4" (146 mm)	
608-3	cabinet	1/8" (3 mm)	3" (76 mm)	5-3/4" (146 mm)	

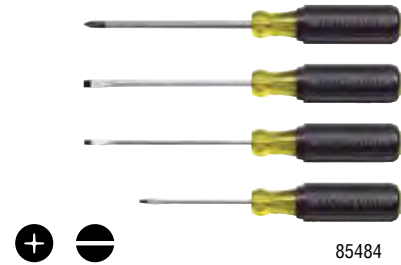

85484

5-Piece TORX® Screwdriver Set

Additional Features:

- TORX® drive systems transmit more torque to the work and reduce slippage, saving fasteners.
- Chrome-plated shafts resist corrosion.

Cat. No.	Set Contains				Weight (lbs.)
19555					1.20
Cat. No.	TORX® Size	Color Code	Shank Length	Overall Length	
19542	T15	yellow	4" (102 mm)	7-3/4" (197 mm)	
19543	T20	green	4" (102 mm)	7-3/4" (197 mm)	
19544	T25	blue	4" (102 mm)	7-3/4" (197 mm)	
19545	T27	brown	4" (102 mm)	8-5/16" (211 mm)	
19546	T30	red	4" (102 mm)	8-5/16" (211 mm)	



19555

TORX® is a registered trademark of Acument Intellectual Properties, LLC.

2-Piece Combo-Tip Screwdriver Set **NEW!**

Additional Features:

- #1 and #2 combination tips.
- Precision machined tip designed for combination head screws.

Cat. No.	Set Contains				Weight (lbs.)
32378					1.50
Cat. No.	Tip Type	Shank Length	Overall Length		
731-4	#1 combo	4" (102 mm)	8-11/32" (212 mm)		
732-4	#2 combo	4" (102 mm)	8-11/32" (212 mm)		



32378

All dimensions are in inches and (millimeters).



www.kleintools.com

See page 310 for additional information on warnings.

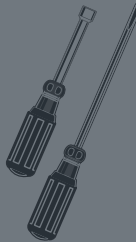

Cushion-Grip Screwdriver Sets

2-Piece 10" Long Blade Screwdriver Set

Additional Features:

- Phillips-tip is precision-machined to provide a more consistent geometric symmetry than conventional Phillips-tip screwdrivers.
- Precision-ground narrow cabinet-tip permits blade access where space is limited.
- Ideal for hard-to-reach places where added length is necessary.
- Includes one Phillips-tip and one cabinet-tip.

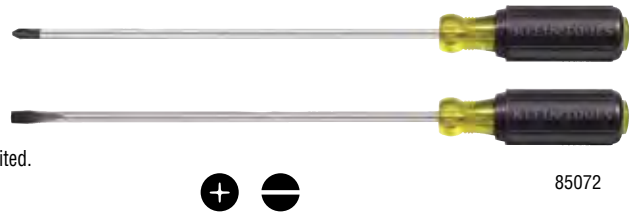

85072

Cat. No.	Set Contains	Weight (lbs.)			
85072		.70			
Cat. No.	Tip Type	Tip Size	Shank Type	Shank Length	Overall Length
603-10	profilated Phillips	#2	round	10" (254 mm)	14-5/16" (363 mm)
605-10	cabinet	3/16" (5 mm)	round	10" (254 mm)	14-5/16" (363 mm)

2-Piece Demolition Screwdriver Set



Additional Features:

- Engineered, manufactured and tested for prying, chiseling and punching
- Plated metal strike cap to protect handle from hammer blows.
- Heat treated metal shaft runs complete length of handle to metal strike cap to transfer metal strike force.

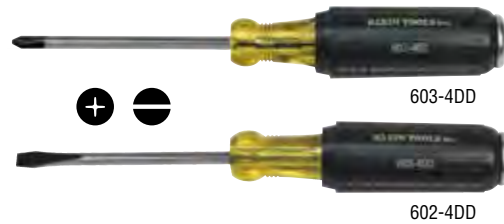

603-4DD

602-4DD

Cat. No.	Set Contains	Weight (lbs.)			
32008		.70			
Cat. No.	Tip Type	Tip Size	Shank Type	Shank Length	Overall Length
602-4DD	profilated Phillips	#2	round	4" (102 mm)	9" (229 mm)
603-4DD	cabinet	1/4" (6 mm)	round	4" (102 mm)	9" (229 mm)

4-Piece Square Recess Screwdriver Set

Additional Feature:

- Works on most combination head receptacle, switch and panel screws.

Cat. No.	Set Contains	Weight (lbs.)			
85664		1.50			
Cat. No.	Point Size	Color Code	Shank Type	Shank Length	Overall Length
660	#0	yellow	round	4" (102 mm)	7-3/4" (197 mm)
661	#1	green	round	4" (102 mm)	7-3/4" (197 mm)
662	#2	red	round	4" (102 mm)	8-5/16" (211 mm)
663	#3	black	round	4" (102 mm)	8-5/16" (211 mm)



85664

2-Piece Stubby Screwdriver Set

Additional Feature:

- Double wings inside handle provide solid, twist-resistant blade anchor.



85071

Cat. No.	Set Contains	Weight (lbs.)			
85071		.30			
Cat. No.	Tip Type	Tip Size	Shank Type	Shank Length	Overall Length
600-1	cabinet	5/16" (8 mm)	round	1-1/2" (38 mm)	3-7/16" (87 mm)
603-1	Phillips	#2	round	1-1/2" (38 mm)	3-7/16" (87 mm)

Stubby Square-Recess Tip Screwdriver Set

Additional Features:

- Double wings inside handle provide solid, twist-resistant blade anchor.
- Works on most combination head receptacle and switch screws.
- Color-coded handle ends for quick and easy identification.



85155

Cat. No.	Set Contains	Weight (lbs.)			
85155		.30			
Cat. No.	Tip Size	Color Code	Shank Type	Shank Length	Overall Length
668	#1	green	round	1-1/2" (38 mm)	3-7/16" (87 mm)
669	#2	red	round	1-1/2" (38 mm)	3-7/16" (87 mm)

All dimensions are in inches and (millimeters).



Switch Drive™ System

NEW!

Switch Drive™ Handle Power Driver Sets

Additional Features:

- Allows for easy alternating between power tool and hand tool on job site.
- Quick-Release mechanism converts power tool accessory to hand tool in a snap.
- Includes Switch Drive™ handle (Cat. No. 32698).



Cat. No.	Tip Type	Tip Size	Bit Length	Overall Length	Weight (lbs.)
32700	Phillips and square recess	#2	6" (152 mm)	14-5/16" (363 mm)	.70
32702	Phillips	#1 & #2	6" (152 mm)	14-5/16" (363 mm)	.70
32703	square recess	#1 & #2	6" (152 mm)	14-5/16" (363 mm)	.70

Switch between **handle**
and **drill** in a snap!

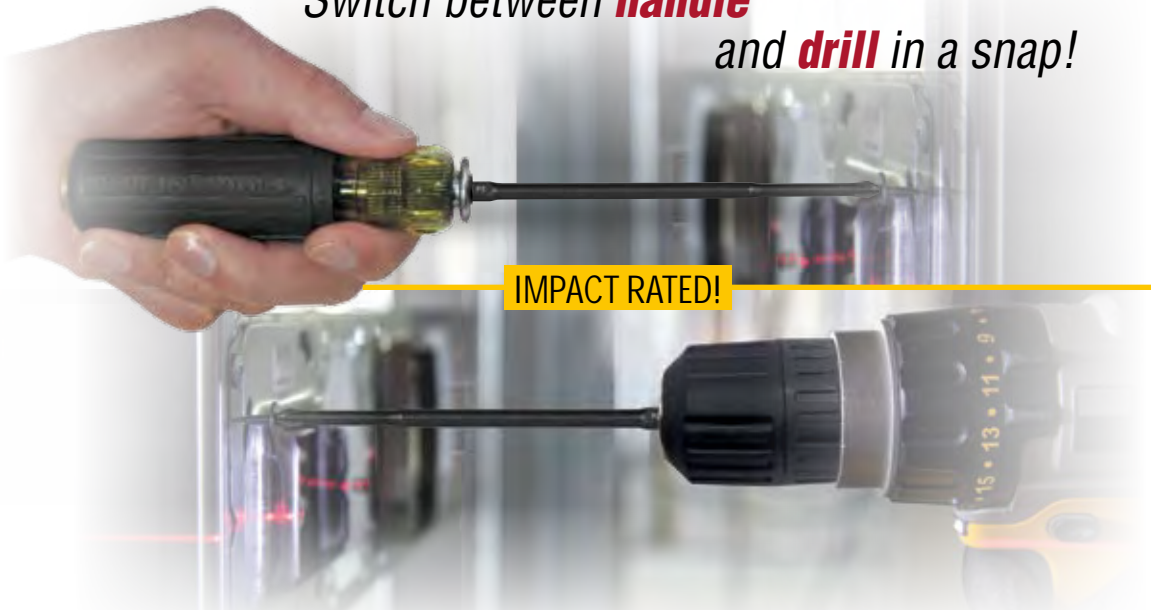

NOTE: Read and follow safety instructions in power tool owner's manual.

All dimensions are in inches and (millimeters).



www.kleintools.com

See page 310 for additional information on warnings.

Screwdrivers, Nut Drivers
& Accessories

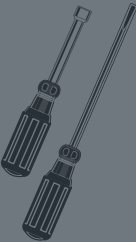

Cushion-Grip Screwdrivers

Keystone-Tip Screwdrivers – Heavy-Duty Square-Shanks

Additional Features:

- Heavy-duty square shank for wrench-assisted turning.
- Bolster reinforces shank for hard use.
- Designed for the most demanding uses.



Cat. No.	Tip Size	Shank Length	Overall Length	Weight (lbs.)
600-4	1/4" (6 mm)	4" (102 mm)	8-11/32" (212 mm)	.25
600-6	5/16" (8 mm)	6" (152 mm)	10-15/16" (278 mm)	.40

Cat. No.	Tip Size	Shank Length	Overall Length	Weight (lbs.)
600-8	3/8" (10 mm)	8" (203 mm)	13-7/16" (341 mm)	.65
600-12	1/2" (13 mm)	12" (305 mm)	17-7/16" (443 mm)	.80

Keystone-Tip Screwdrivers – Heavy-Duty Round-Shanks

Additional Features:

- Built to handle the tough jobs with ease.
- Hex bolster reinforces shank for hard use and allows wrench assisted turning.



Cat. No.	Tip Size	Shank Length	Overall Length	Weight (lbs.)
602-3	7/32" (5 mm)	3" (76 mm)	6-3/4" (171 mm)	.15
600-1	5/16" (8 mm)	1-1/2" (38 mm)	3-7/16" (87 mm)	.10
602-4	1/4" (6 mm)	4" (102 mm)	8-11/32" (212 mm)	.25

Cat. No.	Tip Size	Shank Length	Overall Length	Weight (lbs.)
602-6	5/16" (6 mm)	6" (152 mm)	10-15/16" (278 mm)	.35
602-8	3/8" (10 mm)	8" (203 mm)	13-7/16" (341 mm)	.55
602-10	3/8" (10 mm)	10" (254 mm)	15-7/16" (392 mm)	.60
602-12	3/8" (10 mm)	12" (305 mm)	17-7/16" (443 mm)	.65

* Bolster not available on Cat. No. 600-1

Cabinet-Tip Screwdrivers – Round-Shanks

Additional Feature:

- Narrow cabinet-tip permits blade access where space is limited.



Cat. No.	Tip Size	Shank Length	Overall Length	Weight (lbs.)
601-4	3/16" (5 mm)	4" (102 mm)	7-3/4" (197 mm)	.15
601-6	3/16" (5 mm)	6" (152 mm)	9-3/4" (248 mm)	.15
601-8	3/16" (5 mm)	8" (203 mm)	11-3/4" (298 mm)	.20
601-10	3/16" (5 mm)	10" (254 mm)	13-3/4" (349 mm)	.20

Cat. No.	Tip Size	Shank Length	Overall Length	Weight (lbs.)
Heavy-Duty Shanks				
605-4	1/4" (6 mm)	4" (102 mm)	8-11/32" (212 mm)	.25
605-6	1/4" (6 mm)	6" (152 mm)	10-11/32" (263 mm)	.30
605-8	1/4" (6 mm)	8" (203 mm)	12-11/32" (314 mm)	.30
605-10	1/4" (6 mm)	10" (254 mm)	14-11/32" (365 mm)	.35

Combo-Tip Screwdrivers – Round-Shanks

Additional Feature:

- Precision machined tip designed for combination head screws.

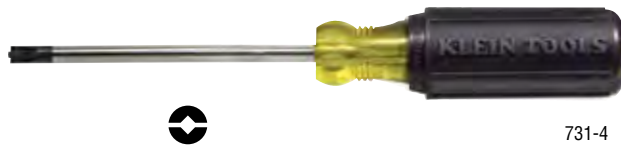

Cat. No.	Tip Size	Shank Length	Overall Length	Weight (lbs.)
731-4	#1 combo	4" (102 mm)	8-11/32" (212 mm)	.30
732-4	#2 combo	4" (102 mm)	8-11/32" (212 mm)	.30

Profilated Phillips-Tip Screwdrivers – Round-Shanks

Additional Features:

- Precision-machined tips provide a more consistent geometric symmetry than conventional Phillips screwdrivers.
- Provides accurate fit and torque without slippage.



Cat. No.	Tip Size	Shank Length	Overall Length	Weight (lbs.)
603-1	#2	1-1/2" (38 mm)	3-7/16" (87 mm)	.10
603-3	#1	3" (76 mm)	6-3/4" (171 mm)	.15
603-4	#2	6" (152 mm)	11" (279 mm)	.35

Cat. No.	Tip Size	Shank Length	Overall Length	Weight (lbs.)
603-6	#3	6" (152 mm)	11" (279 mm)	.35
603-7	#2	7" (178 mm)	11-5/16" (287 mm)	.30
603-10	#2	10" (254 mm)	14-5/16" (364 mm)	.35

All dimensions are in inches and (millimeters).



Cushion-Grip Screwdrivers

Electronics Screwdrivers

Additional Feature:

- Rotating cap for optimum and precise control.

Cat. No.	Tip Type	Tip Size	Shank Length	Overall Length	Weight (lbs.)
614-2	cabinet	1/16"	2" (51 mm)	5-1/2" (140 mm)	.05
613-3	Phillips	#0	3" (76 mm)	6-1/2" (165 mm)	.05
614-3	cabinet	3/32"	3" (76 mm)	6-1/2" (165 mm)	.05



614-6

Cat. No.	Tip Type	Tip Size	Shank Length	Overall Length	Weight (lbs.)
614-4	cabinet	1/8"	4" (102 mm)	7-1/2" (191 mm)	.05
614-6	cabinet	1/8"	6" (152 mm)	9-1/2" (241 mm)	.05

Miniature Screwdrivers

Additional Feature:

- Precision tip for exact fit and rigorous applications.

Cat. No.	Tip Type	Tip Size	Shank Length	Overall Length	Weight (lbs.)
604-3	Phillips	#0	3" (76 mm)	5-3/4" (146 mm)	.04
606-2	keystone	1/16" (1.5 mm)	2" (51 mm)	4-3/4" (121 mm)	.03
607-2	cabinet	3/32" (2 mm)	2" (51 mm)	4-3/4" (121 mm)	.03
607-3	cabinet	3/32" (2 mm)	3" (76 mm)	5-3/4" (146 mm)	.04
607-4	cabinet	3/32" (2 mm)	4" (102 mm)	6-3/4" (171 mm)	.04
608-2	cabinet	1/8" (3 mm)	2" (51 mm)	4-3/4" (121 mm)	.03



608-6

Cat. No.	Tip Type	Tip Size	Shank Length	Overall Length	Weight (lbs.)
608-3	cabinet	1/8" (3 mm)	3" (76 mm)	5-3/4" (146 mm)	.04
608-4	cabinet	1/8" (3 mm)	4" (102 mm)	6-3/4" (171 mm)	.05
608-6	cabinet	1/8" (3 mm)	6" (152 mm)	8-3/4" (222 mm)	.05
608-8	cabinet	1/8" (3 mm)	8" (203 mm)	10-3/4" (273 mm)	.05
608-10	cabinet	1/8" (3 mm)	10" (254 mm)	12-3/4" (324 mm)	.05

Coated Cabinet-Tip Screwdrivers – Round-Shanks

Additional Features:

- Plastic coated for circuit protection only. NOT INSULATED.
- Special plastic coating resists cutting, cracking and chipping.
- Thin coating permits use in confined areas.

Cat. No.	Tip Size	Shank Length	Overall Length	Weight (lbs.)
620-3	3/16" (5 mm)	3" (76 mm)	6-3/4" (171 mm)	.15
621-6	3/16" (5 mm)	6" (152 mm)	9-3/4" (248 mm)	.20
621-8	3/16" (5 mm)	8" (203 mm)	11-3/4" (298 mm)	.20
621-10	3/16" (5 mm)	10" (254 mm)	13-3/4" (349 mm)	.25



620-4

Cat. No.	Tip Size	Shank Length	Overall Length	Weight (lbs.)
Heavy-Duty Shanks				
620-4	1/4" (6 mm)	4" (102 mm)	8-11/32" (212 mm)	.20
620-6	5/16" (8 mm)	6" (152 mm)	10-15/16" (278 mm)	.40
620-8	3/8" (10 mm)	8" (203 mm)	13-7/16" (341 mm)	.60

Square-Recess Tip Screwdrivers – Round-Shanks

Additional Features:

- Color-coded handle ends for quick and easy identification.
- Chrome plated shank for corrosion resistance.

Cat. No.	Tip Size	Color Code	Shank Length	Overall Length	Weight (lbs.)
660	#0	yellow	4" (102 mm)	7-3/4" (197 mm)	.20
661	#1	green	4" (102 mm)	7-3/4" (197 mm)	.20
662	#2	red	4" (102 mm)	8-1/4" (210 mm)	.30
663	#3	black	4" (102 mm)	8-1/4" (210 mm)	.30



660

Cat. No.	Tip Size	Color Code	Shank Length	Overall Length	Weight (lbs.)
665	#1	green	8" (203 mm)	11-3/4" (298 mm)	.30
666	#2	red	8" (203 mm)	12-1/4" (311 mm)	.40
667	#3	black	8" (203 mm)	12-1/4" (311 mm)	.40

All dimensions are in inches and (millimeters).



www.kleintools.com

See page 310 for additional information on warnings.

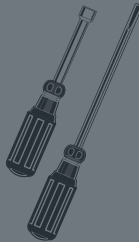

Cushion-Grip Screwdrivers

TORX® Screwdrivers – Round-Shanks

Additional Features:

- TORX® tip drive cuts slippage, saves fasteners and transmits more torque to the work.
- Color-coded handle ends for quick and easy identification.



19544

Cat. No.	TORX® Size	Color Code	Shank Length	Overall Length	Weight (lbs.)
19542	T15	yellow	4" (102 mm)	8-5/16" (211 mm)	.20
19543	T20	green	4" (102 mm)	8-5/16" (211 mm)	.25
19544	T25	blue	4" (102 mm)	8-5/16" (211 mm)	.25

Cat. No.	TORX® Size	Color Code	Shank Length	Overall Length	Weight (lbs.)
19545	T27	brown	4" (102 mm)	8-5/16" (211 mm)	.25
19546	T30	red	4" (102 mm)	8-5/16" (211 mm)	.25

TORX® is a registered trademark of Acument Intellectual Properties, LLC.

Demolition Screwdrivers

Additional Features:

- Engineered, manufactured and tested for prying, chiseling and punching
- Plated metal strike cap to protect handle from hammer blows.
- Heat treated metal shaft runs complete length of handle to metal strike cap to transfer metal strike force.



602-7DD

NEW!



603-4DD

Cat. No.	Tip Type	Tip Size	Blade Length	Overall Length	Weight (lbs.)
602-4DD	keystone	1/4" (6 mm)	4" (102 mm)	9" (229 mm)	.37
602-7DD	keystone	5/16" (8 mm)	7" (178 mm)	12-3/8" (314 mm)	.56
603-4DD	Phillips	#2	7" (178 mm)	9" (229 mm)	.37 NEW!



Rapi-Driv™ Cushion-Grip Screwdrivers

Rapi-Driv® Screwdrivers

Additional Features:

- Crank-action handle spins screws fast with one hand.
- Saves time and effort, especially on long-threaded screws in switch plates, light fixtures, etc.



670-6

Cat. No.	Tip Type	Tip Size	Shank Length	Overall Length	Weight (lbs.)
670-3	cabinet	3/16" (5 mm)	4" (102 mm)	7-3/4" (197 mm)	.15
670-6	cabinet	3/16" (5 mm)	6" (152 mm)	9-3/4" (248 mm)	.20
671-6	cabinet	1/4" (6 mm)	6" (152 mm)	9-3/4" (248 mm)	.20
681-6	Phillips	#1	6" (152 mm)	9-3/4" (248 mm)	.20
682-6	Phillips	#2	6" (152 mm)	9-3/4" (248 mm)	.25
691-6	square-recess	#1	6" (152 mm)	9-3/4" (248 mm)	.35
692-6	square-recess	#2	6" (152 mm)	9-3/4" (248 mm)	.35

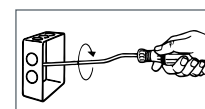

Interchangeable Rapi-Driv™

Additional Features:

- Interchangeable bit holder allows quick switching between tip styles and works with other standard size bits.
- Crank-action handle allows you to spin screws fast with one hand.
- Blast finish bit provides firm grip on fasteners to reduce cam out.



67100

Cat. No.	Contains	Shaft Length	Overall Length	Weight (lbs.)
67100	3/16" (5 mm) slotted, #2 Phillips	6" (152 mm)	9-3/4" (248 mm)	.26

2-in-1 Replacement Bit

Cat. No.	Fits	Description	Quantity	Weight (lbs.)
67101	2-in-1 Rapi-Driv™, 10-in-1, 11-in-1 and 10-Fold™	3/16" (5 mm) slotted, #2 Phillips replacement bit	contains 2 bits	.012

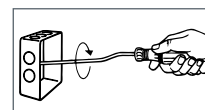

All dimensions are in inches and (millimeters).



www.kleintools.com

See page 310 for additional information on warnings.

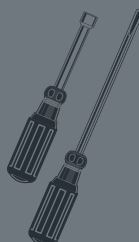

Conduit Reamers

Power Conduit Reamer

- Ream 1/2" (13 mm), 3/4" (19 mm), and 1" (25 mm) conduit and install fittings in a fraction of the time.
- Designed to fit into power drill chucks and quick release adapters; impact ready.
- Includes precision engineered replaceable reaming blade.
- Replacement blades are available and the only approved blade for use in this tool.
- Replacement bits are available but any standard 1/4" hex bit will work.



85091



Cat. No.	Description	Weight (lbs.)
85091	conduit reamer drill head for 1/2" (13 mm), 3/4" (19 mm), 1" (25 mm) conduit	.33 lbs.
19353	conduit reamer replacement blade	.01 lbs.
SQ2115	#2 square recess replacement bit, 15-pack	.01 lbs.

NOTE: Read and follow safety instructions in power tool owner's manual.

Conduit-Fitting and Reaming Screwdriver

Additional Features:

- Hooded-blade design keeps tip from slipping out of screws, especially when tightening hard-to-reach conduit fittings. Thicker hood is designed for rugged use.
- Reams and smooths 1/2" (13 mm), 3/4" (19 mm), and 1" (25 mm) thin-wall conduit ends to protect wire and permit correct installation of fittings.
- Reams both the inside and outside of the conduit at the same time.
- Replaceable reaming blade is now held in place with a 1/16" (1.5 mm) set screw.



85191

Cat. No.	Tip Size	Shank Length	Overall Length	Weight (lbs.)
85191	5/16" (8 mm)	2-1/2" (64 mm)	7-1/2" (191 mm)	.50
19353	conduit reamer replacement blade kit			.01

Conduit Reamer

- Locks onto screwdrivers; reams and smooths thin-wall conduit.
- Reams ID and OD at the same time.
- Two set-screws for round- and square-shank screwdrivers.
- Fits up to 3/8" (10 mm) keystone-tip screwdrivers.
- NOT for use on power tools.



19352

Cat. No.	Conduit Capacity	Weight (lbs.)
19352	1/2" (13 mm), 3/4" (19 mm), 1" (25 mm)	.20
19353	conduit reamer replacement blade kit for 19352	.01

Specialty Cushion-Grip Screwdrivers

Screw-Holding Screwdrivers

Additional Features:

- Starts and drives screws with one hand when working in hard-to-reach spaces.



32215

Cat. No.	Tip Type	Tip Type	Shank Length	Overall Length	Weight (lbs.)
32215	cabinet	1/4" (6 mm)	7" (178 mm)	11-1/4" (276 mm)	0.32
32216	Phillips	#2	7" (178 mm)	11-1/4" (276 mm)	0.32

All dimensions are in inches and (millimeters).



www.kleintools.com

See page 310 for additional information on warnings.

Specialty Cushion-Grip Screwdrivers

Terminal Block Screwdriver

Additional Features:

- Precision-machined cabinet tip provides exact fit for terminal block screws.
- Tip is up to 19% stronger than competitors and provides 76% higher torque value than the required ASME B107 Standard.

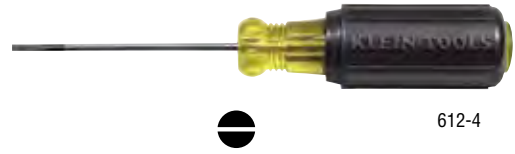

Cat. No.	Shank Tip Width	Shank Length	Overall Length	Weight (lbs.)
612-4	1/8" (3 mm)	4" (100 mm)	7-3/4" (200 mm)	0.15

Wire Bending Screwdrivers – Round-Shanks

Additional Feature:

- Metal stud offers a convenient and easy way to bend, loop and connect solid wire when installing outlets and switches.

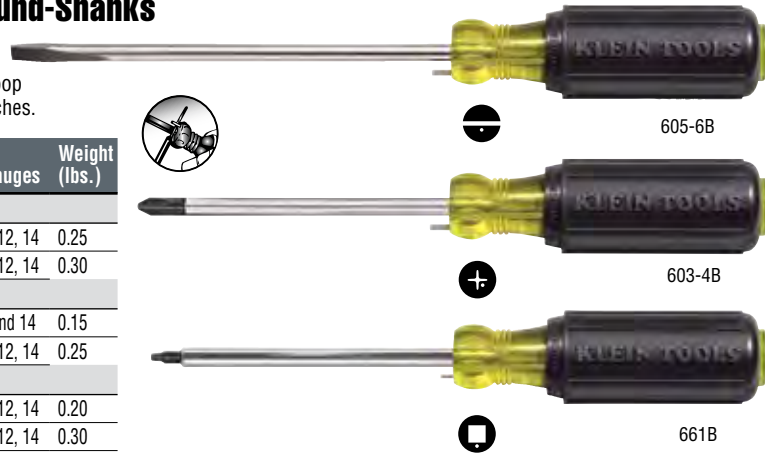

Cat. No.	Tip Size	Shank Length	Overall Length	Bends AWG Gauges	Weight (lbs.)
Cabinet Tip					
605-4B	1/4" (6 mm)	4" (102 mm)	8-11/32" (212 mm)	Nos. 10, 12, 14	0.25
605-6B	1/4" (6 mm)	6" (152 mm)	10-11/32" (263 mm)	Nos. 10, 12, 14	0.30
Phillips Tip					
603-3B	#1	3" (76 mm)	6-3/4" (171 mm)	Nos. 12 and 14	0.15
603-4B	#2	4" (102 mm)	8-5/16" (211 mm)	Nos. 10, 12, 14	0.25
Square Recess					
661B	#1	4" (102 mm)	8-1/4" (210 mm)	Nos. 10, 12, 14	0.20
662B	#2	4" (102 mm)	8-1/4" (210 mm)	Nos. 10, 12, 14	0.30

Multi-Bit Cushion-Grip Screwdrivers/Nut Drivers

Heavy-Duty Multi-Bit Screwdriver/Nut Driver

- Superior torque for tough applications.
- Interchangeable shaft holds six universal tips; converts to three nut driver sizes and one hex driver
- Strong, heat-treated nut drivers for improved torque.



Cat. No.	Shaft Length	Overall Length	Weight (lbs.)
32557	2.95" (75 mm)	7.9" (201 mm)	0.48



Ratcheting Multi-Bit Screwdriver/Nut Driver

- High torque 3-way ratcheting mechanism, forward, reverse and locked positions for tough applications.
- Interchangeable shaft holds six universal tips; converts to three nut driver sizes and one hex driver
- Strong, heat-treated nut drivers for improved torque.



Cat. No.	Shaft Length	Overall Length	Weight (lbs.)
32558	2.95" (75 mm)	7.9" (201 mm)	0.48



Extended-Reach Multi-Bit Screwdrivers/Nut Drivers

- Interchangeable shaft holds four universal tips and converts to two nut driver sizes.
- Extended shafts and blades provide 39% longer reach.
- Small diameter shaft for comfortable grip and quick, easy turning.



Cat. No.	Shaft Length	Overall Length	Weight (lbs.)
32559	4.11" (104 mm)	9.1" (231 mm)	0.41
32560	4.11" (104 mm)	9.1" (231 mm)	0.41

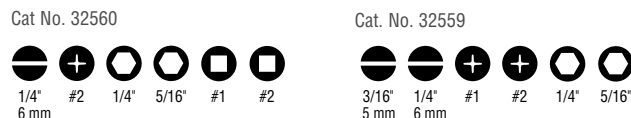

All dimensions are in inches and (millimeters).



Multi-Bit Cushion-Grip Screwdrivers/Nut Drivers

Stubby Multi-Bit Screwdriver/Nut Driver

- Compact design features standard 1-1/4" (32 mm) shaft allowing easy access to tight work spaces.
- Shaft holds four universal tips and converts to two nut driver sizes.

Cat. No.	Shaft Length	Overall Length	Weight (lbs.)
32561	1.27" (32 mm)	3.4" (86 mm)	0.16
32562	1.27" (32 mm)	3.4" (86 mm)	0.16

Cat. No. 32561



Cat. No. 32562



US Patent: D684836



Multi-Bit Screwdrivers/Nut Drivers

- Integrated screwdriver/nut driver shaft holds popular tips and converts nut driver sizes.

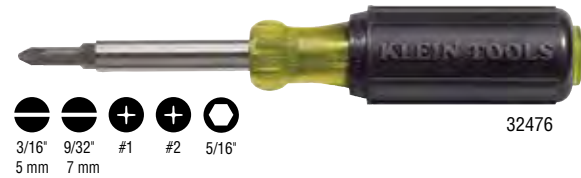

Cat. No.	Description	Shaft Length	Overall Length	Weight (lbs.)
32476	5-in-1	4" (100 mm)	7-3/4" (200 mm)	0.48
32477	10-in-1	4" (100 mm)	7-3/4" (200 mm)	0.50
32500	11-in-1	4" (100 mm)	7-3/4" (200 mm)	0.50

Note: Cat. No. 32476 has 5/16" nut driver only
TORX® is a registered trademark of Acument Intellectual Properties, LLC.

11-in-1 Screwdriver/Nut Driver with Schrader® Valve Removal/ Installation Bit

- Great for HVAC and other industrial applications.
- Includes unique style bit for installation/removal of common TR-4 Schrader® valves and aggressive thread extractor tip for backing out broken cores.

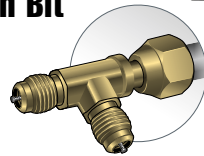

Cat. No.	Shaft Length	Overall Length	Weight (lbs.)
32527	4" (100 mm)	7-3/4" (200 mm)	0.50

Schrader® is a registered trademark of Schrader-Bridgeport International, Inc.



11-in-1 Combo-Tip Screwdriver/Nut Driver

- Precision machined tip designed for combination head screws.
- Includes #1 & #2 combination, slotted, square and Phillips tips.

Cat. No.	Shaft Length	Overall Length	Weight (lbs.)
32505	4" (100 mm)	7-3/4" (200 mm)	0.50



Multi-Bit Tap Tool Driver

- Increases job speed by combining taps and drivers in one tool.
- Six common tap sizes (6-32, 8-32, 10-32, 10-24, 12-24, 1/4-20).

Cat. No.	Shaft Length	Overall Length	Weight (lbs.)
32517	4" (100 mm)	7-3/4" (200 mm)	0.50

Replacement Tap	Weight (lbs.)
32518 Tap sizes 6-32, 8-32, 10-32, 10-24, 12-24, 1/4-20	0.05



All dimensions are in inches and (millimeters).



www.kleintools.com

See page 310 for additional information on warnings.

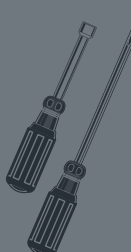

Multi-Bit Screwdrivers/Nut Drivers

10-in-1 Folding Screwdriver/Nut Driver *10-FOLD™*

- Conveniently folds up for easy storage or to fit into your pocket.
- Each driver arm contains four interchangeable bit styles and two nut drivers.
- Unfold each driver arm up to a full 180° for straight on driving power, or at 90° for extra leverage on stubborn fasteners.
- The quick release button easily unlocks a fully extended driver arm.

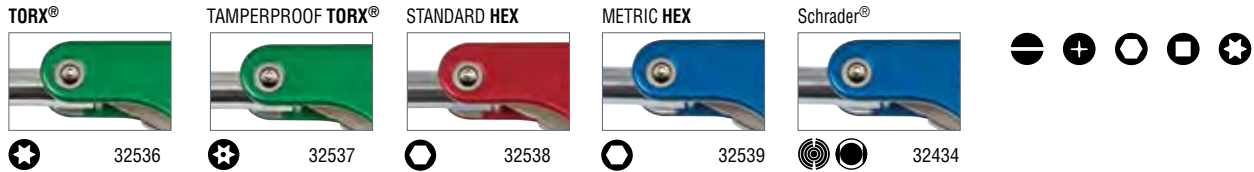

Cat. No.	Handle Color	Screwdrivers	Nut Drivers	Hex	Weight (lbs.)
32535	black	#1 and #2 Phillips, 1/4" (6 mm) & 3/16" (5 mm) slotted, T10 & T15 TORX®, #1 and #2 square-recess	5/16" & 1/4"	N/A	0.37
32536	green	T6, T7, T8, T10, T15, T20, T25, T27 TORX®	5/16" & 1/4"	N/A	0.37
32537	green	T7, T8, T9, T10, T15, T20, T25, T27 TORX®	5/16" & 1/4"	N/A	0.37
32538	red	N/A	5/16" & 1/4"	1/16" (1.5 mm), 5/64" (2 mm), 3/32" (2.3 mm), 7/64" (2.5 mm), 1/8" (3 mm), 9/64" (3.5 mm), 5/32" (4 mm), 3/16" (5 mm)	0.37
32539	blue	N/A	8 mm & 6 mm	.9 mm, 1.3 mm, 1.5 mm, 2 mm, 2.5 mm, 3 mm, 4 mm, 5 mm	0.37
32534	blue	#1 and #2 Phillips, 1/4" (6 mm) & 3/16" (5 mm) slotted, #1 and #2 square-recess and valve core removal/installation - extractor	5/16" & 1/4"	N/A	0.37

Schrader® is a registered trademark of Schrader-Bridgeport International, Inc.
TORX® is a registered trademark of Acument Intellectual Properties, LLC.

Replacement Parts Multi-Bit Screwdriver/Nut Drivers

Replacement Parts for Multi-Bit Screwdriver/Nut Drivers

- Precision-machined tips for exact fit into fastener.



Cat. No.	Fits	Description	Quantity
32392	Heavy Duty (32557) & Ratcheting (32558)	Heavy Duty Main Blade Barrel	1 unit
32394	Heavy Duty (32557) & Ratcheting (32558)	Heavy Duty Secondary Blade Barrel	2 units
32395	Extended Reach Drivers (32559 & 32560)	Extended Blade Barrel	1 unit
32396	Stubby Drivers (32561 & 32562)	Stubby Blade Barrel	1 unit
32397	Heavy Duty (32557) & Ratcheting (32558)	Screwdriver Bit & #2 Phillips x #1 Square	2 bits
32398	Heavy Duty (32557), Ratcheting (32558) & Stubby (32561)	Screwdriver Bit & #1 Phillips x 1/4" (6 mm) Slotted	2 bits
32399	Heavy Duty (32557) & Ratcheting (32558)	Screwdriver Bit & #2 Square x 3/16" (5 mm) Slotted	2 bits
32400	Extended Reach (32559)	Extended Screwdriver Bit & #2 Phillips x #1 Phillips	2 bits
32401	Extended Reach (32559)	Extended Screwdriver Bit & 3/16" (5 mm) and 1/4 (6 mm) Slotted	2 bits
32410	Stubby Driver (32560)	Extended Screwdriver Bit & #2 Square x #2 Phillips	2 bits
32411	Stubby Driver (32560)	Extended Screwdriver Bit & #1 Square x 1/4" (6 mm) Slotted	2 bits
32412	Stubby Driver (32561)	Screwdriver Bit & #2 Phillips x 3/16" (5 mm) Slotted	2 bits

Replacement Bits for 5-in-1 Multi-Bit Screwdriver/Nut Driver



Cat. No.	Fits	Description	Quantity
32478	5-in-1 (32476)	#1 Phillips - 3/16" (5 mm) slotted	1 bit
32479	5-in-1 (32476)	#2 Phillips - 9/32" (7 mm) slotted	1 bit

All dimensions are in inches and (millimeters).



Replacement Parts Multi-Bit Screwdriver/Nut Drivers

Replacement Bits for Multi-Bit Screwdriver/Nut Drivers 10-in-1, 11-in-1 & 10-Fold™



Cat. No.	Fits	Description	Quantity
32482	10-in-1, 11-in-1 & 10-Fold™	#1 Phillips & 3/16" (5 mm) Slotted	2 bits
32483	10-in-1, 11-in-1 & 10-Fold™	#2 Phillips & 1/4" (6 mm) Slotted	2 bits
32484	10-in-1, 11-in-1 & 10-Fold™	#1 Square & #2 Square	2 bits
67101	10-in-1, 11-in-1 & 10-Fold™	#2 Phillips & 3/16" (5 mm) Slotted	2 bits
32518	Multi-Bit Tap Tool (32517)	Double ended tap 6-32, 8-32, 10-32, 10-24, 12-24, 1/4-20	6 taps NEW!
32528	11-in-1 Schrader (32527)	valve core removal/installation – extractor	1 bit
32540	10-in-1, 11-in-1 & 10-Fold™	TT7 & TT8 Tamperproof TORX®	2 bits
32541	10-in-1, 11-in-1 & 10-Fold™	TT9 & TT10 Tamperproof TORX®	2 bits
32542	10-in-1, 11-in-1 & 10-Fold™	TT15 & TT20 Tamperproof TORX®	2 bits
32543	10-in-1, 11-in-1 & 10-Fold™	TT25 & TT27 Tamperproof TORX®	2 bits
32544	10-in-1, 11-in-1 & 10-Fold™	T6 & T7 TORX®	2 bits

Cat. No.	Fits	Description	Quantity
32485	10-in-1, 11-in-1 & 10-Fold™	T10 & T15 TORX®	2 bits
32545	10-in-1, 11-in-1 & 10-Fold™	T8 & T10 TORX®	2 bits
32546	10-in-1, 11-in-1 & 10-Fold™	T25 & T27 TORX®	2 bits
32547	10-in-1, 11-in-1 & 10-Fold™	3/32" & 7/64" Hex	2 bits
32548	10-in-1, 11-in-1 & 10-Fold™	5/32" & 3/16" Hex	2 bits
32549	10-in-1, 11-in-1 & 10-Fold™	1/16" & 5/64" Hex	2 bits
32550	10-in-1, 11-in-1 & 10-Fold™	1/8" & 9/64" Hex	2 bits
32551	10-in-1, 11-in-1 & 10-Fold™	.9 mm Hex & 1.3 mm Hex	2 bits
32552	10-in-1, 11-in-1 & 10-Fold™	1.5 mm Hex & 2 mm Hex	2 bits
32553	10-in-1, 11-in-1 & 10-Fold™	2.5 mm Hex & 3 mm Hex	2 bits
32554	10-in-1, 11-in-1 & 10-Fold™	4 mm Hex & 5 mm Hex	2 bits
32752	Combo-Tip Multi-Tool (32505)	#1 and #2 Double-Sided Combo Bit	2 bits NEW!

Schrader® is a registered trademark of Schrader-Bridgeport International, Inc.

Magnetic Screwdriver Bit Sets

Non-Ratcheting Magnetic Screwdriver with 32-Piece Tamperproof Bit Set

- Sturdy bit and screw holding magnet allows for screws to fit securely in place for easy use.
- Durable PVC black block allows for easy storage of standard 1/4" bits.
- Includes complete tamperproof bit set in block.



32510

Cat. No.	Set Contains	Weight (lbs.)
32510	Bits Included TORX® – T7, T8, T10, T15, T20, T25, T27, T30 & T40 Fraction Hex – 3/32", 7/64", 1/8", 9/64", 5/32", & 3/16" Metric Hex – 2 mm, 2.5 mm, 3 mm, 4 mm, & 5 mm Spanner – 4, 6, 8, & 10 Tri-Wing® – 1, 2, 3 & 4 TORQ-SET® – 6, 8 & 10 1/4" (6 mm) square to 1/4" (6 mm) hex adapter to drive sockets	.71

TORX® is a registered trademark of Acument Intellectual Properties, LLC. TORQ-SET® and Tri-Wing® are registered trademarks of Phillips Screw Co.

32-Piece Bit Sets

- Durable PVC black block allows for easy storage of standard 1/4" bits.
- Block slides over most screwdriver shafts for easy bit access and storage.
- Industrial strength, heat-treated steel bits for long lasting use.
- 1/4" square to 1/4" hex adapter to drive sockets



32526



32525

Cat. No.	Set Contains	Weight (lbs.)
32526	32-Piece Standard Tip Bits Included Hex – 5/64", 3/32", 7/64", 1/8", 9/64", 5/32" & 3/16" Phillips – #0, #1, #2 & #3 Square Recess – #1, #2 & #3 TORX® – T6, T7, T8, T10, T15, T20 & T25 Slotted – 3-4, 5-6, 6-8, 8-10, 10-12 & 12-14 screw sizes Clutch – 5/32" & 3/16"	0.425

Cat. No.	Set Contains	Weight (lbs.)
32525	32-Piece Tamperproof Tip Bits Included TORX® – T7, T8, T10, T15, T20, T25, T27, T30 & T40 Fraction Hex – 5/64", 3/32", 7/64", 1/8", 9/64", 5/32", & 3/16" Metric Hex – 2 mm, 2.5 mm, 3 mm, 4 mm & 5 mm Spanner – 4, 6, 8, and 10 Tri-Wing® – 1, 2, 3 and 4 TORQ-SET® – 6, 8 & 10	0.425

All dimensions are in inches and (millimeters).



www.kleintools.com

See page 310 for additional information on warnings.

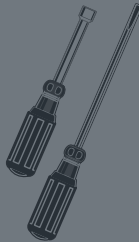

Journeyman™ Screwdrivers

JOURNEYMAN

Features:

Hex-shaped welded bolster offers additional strength between the blade and handle.

Ultra-comfortable tri-lobe handle exceptional control, grip, and balance.

Precision-machined tip for exact fit into the fastener.



Exceptionally hard steel shaft efficiently transfers every bit of torque generated into the tip.

Meets or exceeds applicable ASME / ANSI specifications.

Tip-Ident® quickly identifies the type of screwdriver and tip orientation.

5-Piece Journeyman™ Screwdriver Set

Additional Features:

- General purpose selection of the most frequently used screwdrivers.

Cat. No.	Set Contains	Weight (lbs.)		
JSDS01		1.15		
Cat. No.	Tip Type	Tip Size	Shaft Length	Overall Length
JSD6C06	cabinet	3/16" (5 mm)	6" (152 mm)	10-1/4" (260 mm)
JSD4K08	keystone	1/4" (6 mm)	4" (102 mm)	9" (228 mm)
JSD6K09	keystone	5/16" (8 mm)	6" (152 mm)	11" (279 mm)
JSD4PH1	Phillips	#1	4" (102 mm)	8-1/4" (210 mm)
JSD4PH2	Phillips	#2	4" (102 mm)	9" (228 mm)



JSDS01

7-Piece Journeyman™ Screwdriver Set

Additional Features:

- Accommodates a broad range of standard fastener sizes.

Cat. No.	Set Contains	Weight (lbs.)		
JSDS02		1.65		
Cat. No.	Tip Type	Tip Size	Shaft Length	Overall Length
JSD4C06	cabinet	3/16" (5 mm)	4" (102 mm)	8-1/4" (210 mm)
JSD6C06	cabinet	3/16" (5 mm)	6" (152 mm)	10-1/4" (260 mm)
JSD4K08	keystone	1/4" (6 mm)	4" (102 mm)	9" (228 mm)
JSD6K09	keystone	5/16" (8 mm)	6" (152 mm)	11" (279 mm)
JSD4PH1	Phillips	#1	4" (102 mm)	8-1/4" (210 mm)
JSD4PH2	Phillips	#2	4" (102 mm)	9" (228 mm)
JSD6PH3	Phillips	#3	6" (152 mm)	11" (279 mm)



JSDS02

All dimensions are in inches and (millimeters).



www.kleintools.com

See page 310 for additional information on warnings.

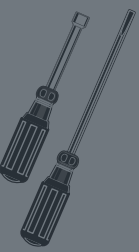

Journeyman™ Screwdrivers

Journeyman™ Screwdrivers – Round Shafts

JOURNEYMAN

Cat. No.	Tip Type	Tip Size	Shaft Length	Overall Length	Weight (lbs.)
JSD4K08	keystone	1/4" (6 mm)	4" (102 mm)	9" (228 mm)	0.25
JSD6K09	keystone	5/16" (8 mm)	6" (152 mm)	11" (279 mm)	0.35
JSD4C06	cabinet	3/16" (5 mm)	4" (102 mm)	8-1/4" (210 mm)	0.15
JSD6C06	cabinet	3/16" (5 mm)	6" (152 mm)	10-1/4" (260 mm)	0.15
JSD4PH1	Phillips	#1	4" (102 mm)	8-1/4" (210 mm)	0.15
JSD4PH2	Phillips	#2	4" (102 mm)	9" (228 mm)	0.25
JSD6PH3	Phillips	#3	6" (152 mm)	11" (279 mm)	0.35



JSD6K09



JSD6C06



JSD4PH2

Plastic-Handle Screwdriver Set

Features:

Meets or exceeds applicable ASME / ANSI and MIL specifications.

Smooth Comfordome® handles fit the palm of the hand comfortably.

Nickel-chrome, precision-forged and polished blades with black tips.

Tough amber plastic handle.

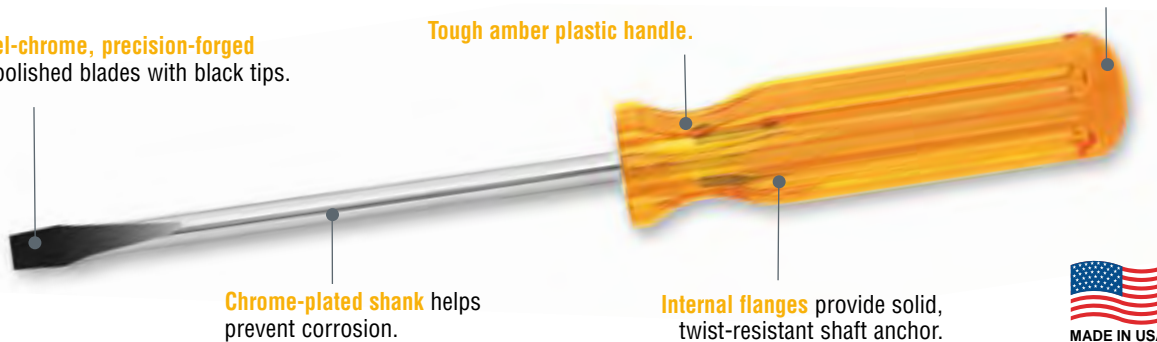

Chrome-plated shank helps prevent corrosion.

Internal flanges provide solid, twist-resistant shaft anchor.



7-Piece Combination Screwdriver Set

Additional Features:

- Set contains two Phillips-tip screwdrivers, two slotted keystone-tip screwdrivers and three popular cabinet-tip screwdrivers.

Cat. No.	Set Contains	Weight (lbs.)
85276		1.10

Cat. No.	Tip Type	Tip Size	Shank Type	Shank Length
BD284	keystone	1/4" (6 mm)	square	4" (102 mm)
BD306	keystone	5/16" (8 mm)	square	6" (152 mm)
A216-3	cabinet	1/8" (3 mm)	round	3" (76 mm)
A216-4	cabinet	1/8" (3 mm)	round	4" (102 mm)
A216-6	cabinet	1/8" (3 mm)	round	6" (152 mm)
BD111	Phillips	#1	round	3" (76 mm)
BD122	Phillips	#2	round	4" (102 mm)



85276

All dimensions are in inches and (millimeters).



www.kleintools.com

See page 310 for additional information on warnings.

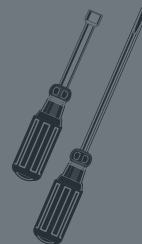

Plastic-Handle Screwdrivers

Pocket-Clip Screwdrivers

Additional Features:

- Specially designed for delicate instrument work.
- Cat. No. A000 does not have a pocket clip.

Cat. No.	Tip Size	Shank Length	Overall Length	Weight (lbs.)
Keystone Tip				
A000	3/32" (2 mm)	1.5" (38 mm)	2-7/8" (73 mm)	.02
A010	3/32" (2 mm)	1-3/8" (35 mm)	3-1/4" (82 mm)	.03
Keystone Tip				
A130-2	1/8" (3 mm)	2" (51 mm)	3-7/8" (98 mm)	.05
A130-3	1/8" (3 mm)	3" (76 mm)	4-7/8" (124 mm)	.04
A116-2	3/32" (2 mm)	2" (51 mm)	4-7/16" (113 mm)	.05
A116-3	3/32" (2 mm)	3" (76 mm)	5-7/16" (138 mm)	.03
A116-4	3/32" (2 mm)	4" (102 mm)	6-7/16" (164 mm)	.03
A131-2	1/8" (3 mm)	2" (51 mm)	4-7/16" (113 mm)	.05
P12	#0	2 1/2" (63 mm)	5" (124 mm)	.05

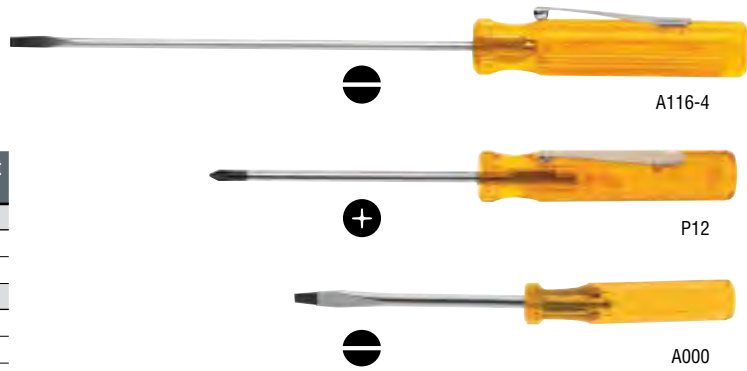

Bull Driver™ Plastic Handle Screwdrivers

Additional Features:

- Oversized handle is 35% larger than comparable screwdriver handles.
- Delivers up to 50% extra power to perform tough jobs with minimum effort.

Cat. No.	Tip Size	Shank Type	Shank Length	Overall Length	Weight (lbs.)
Keystone Tip					
BD284	1/4" (6 mm)	square	4" (102 mm)	8-1/2" (216 mm)	.25
BD286	1/4" (6 mm)	square	6" (152 mm)	10-1/2" (267 mm)	.30
BD306	5/16" (8 mm)	square	6" (152 mm)	11-3/16" (284 mm)	.35
BD308	5/16" (8 mm)	square	8" (203 mm)	13-3/16" (335 mm)	.40
BD310	5/16" (8 mm)	square	10" (254 mm)	15-3/16" (385 mm)	.50
BD410	3/8" (10 mm)	square	10" (254 mm)	15-3/16" (385 mm)	.60
BD412	3/8" (10 mm)	square	12" (305 mm)	17-3/16" (437 mm)	.75
C718	3/8" (10 mm)	square	18" (457 mm)	23-5/16" (592 mm)	.95
BD143	7/32" (2 mm)	round	3" (76 mm)	7-1/2" (190 mm)	.20
BD144	1/4" (6 mm)	round	4" (102 mm)	8-1/2" (216 mm)	.25

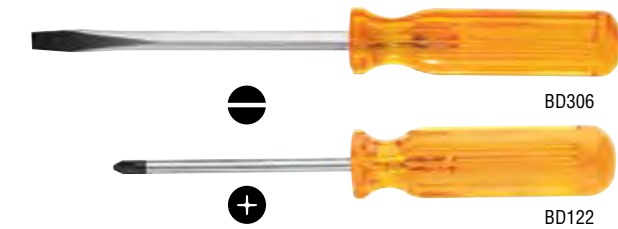

Cat. No.	Tip Size	Shank Type	Shank Length	Overall Length	Weight (lbs.)
Keystone Tip					
BD146	1/4" (6 mm)	round	6" (152 mm)	10-1/2" (267 mm)	.25
BD156	5/16" (8 mm)	round	6" (152 mm)	11-3/16" (284 mm)	.35
BD158	5/16" (8 mm)	round	8" (203 mm)	13-3/16" (335 mm)	.40
BD408	3/8" (10 mm)	round	8" (203 mm)	13-3/16" (335 mm)	.50
BD510	3/8" (10 mm)	round	10" (254 mm)	15-3/16" (386 mm)	.55
70155	1/4" (6 mm)	round	20" (508 mm)	24-1/2" (622 mm)	.45
Phillips Tip					
BD111	#1	round	3" (76 mm)	6-5/8" (168 mm)	.10
BD122	#2	round	4" (102 mm)	8-1/2" (216 mm)	.20
BD133	#3	round	6" (152 mm)	11-3/16" (284 mm)	.35

Profiliated Phillips Tip Screwdrivers

Additional Features:

- Precision-machined tips provide a more consistent geometric symmetry to ensure accurate fit and torque without slippage.

Cat. No.	Tip Size	Shank Type	Shank Length	Overall Length	Weight (lbs.)
P18	#1	round	8" (203 mm)	11-1/2" (292 mm)	.15
P28	#2	round	8" (203 mm)	11-5/8" (295 mm)	.20

Cat. No.	Tip Size	Shank Type	Shank Length	Overall Length	Weight (lbs.)
P212	#2	round	12" (305 mm)	15-5/8" (397 mm)	.25
P202	#2	round	20" (508 mm)	24-1/2" (622 mm)	.55



Cabinet-Tip Screwdrivers – Round-Shanks

Additional Features:

- Small-diameter cabinet-tip shank for use in recessed holes or tight places.
- Well-suited for electrical and telecommunications work.

Cat. No.	Tip Size	Shank Length	Overall Length	Weight (lbs.)
A216-2	1/8" (3 mm)	2" (51 mm)	5" (127 mm)	.05
A216-3	1/8" (3 mm)	3" (76 mm)	6" (152 mm)	.05
A216-4	1/8" (3 mm)	4" (102 mm)	7" (178 mm)	.05
A216-6	1/8" (3 mm)	6" (152 mm)	9" (228 mm)	.05
A216-8	1/8" (3 mm)	8" (203 mm)	11" (279 mm)	.05
A216-10	1/8" (3 mm)	10" (254 mm)	13" (330 mm)	.05

Cat. No.	Tip Size	Shank Length	Overall Length	Weight (lbs.)
A316-3	3/16" (5 mm)	3" (76 mm)	6-5/8" (168 mm)	.10
A316-4	3/16" (5 mm)	4" (102 mm)	7-5/8" (194 mm)	.10
A316-6	3/16" (5 mm)	6" (152 mm)	9-5/8" (244 mm)	.10
A316-8	3/16" (5 mm)	8" (203 mm)	11-5/8" (295 mm)	.15
A316-10	3/16" (5 mm)	10" (254 mm)	13-5/8" (346 mm)	.20
70155	1/4" (6 mm)	20" (508 mm)	24-1/2" (622 mm)	.45



All dimensions are in inches and (millimeters).

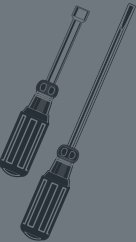

Screw-Holding Screwdrivers

3-Piece Slotted Plastic Handle Screw-Holding Screwdriver Set

- Not designed for torquing or tightening.

Cat. No.	Set Contains	Weight (lbs.)
SK234		.40
Cat. No.	Tip Size	Shank Size
K23	3/16" (5 mm)	3" (76 mm)
K34	1/4" (6 mm)	4" (102 mm)
K46	5/16" (8 mm)	8" (152 mm)



SK234

Slotted Plastic Handle Screw-Holding Screwdrivers

- Positive gripping action holds, starts, and drives slotted screws in awkward, hard-to-reach places.
- Split-blade screw-holding driver wedges into screw slot.
- Not designed for torquing or tightening.

Cat. No.	Tip Size	Shank Length	Overall Length	Weight (lbs.)
K21†	1/16" (15 mm)	3" (76 mm)	5-1/4" (133 mm)	.05
K23	3/16" (5 mm)	3" (76 mm)	5-1/4" (133 mm)	.05
K28	3/16" (5 mm)	8" (203 mm)	10-1/4" (260 mm)	.10
K34‡	1/4" (6 mm)	4" (102 mm)	7-3/4" (197 mm)	.10
K36‡	1/4" (6 mm)	6" (152 mm)	9-3/4" (247 mm)	.15



K36

Cat. No.	Tip Size	Shank Length	Overall Length	Weight (lbs.)
K38‡	1/4" (6 mm)	8" (203 mm)	11-3/4" (298 mm)	.20
K44	5/16" (8 mm)	4" (102 mm)	8-1/4" (209 mm)	.25
K46	5/16" (8 mm)	6" (152 mm)	10-1/4" (260 mm)	.25
K48	5/16" (8 mm)	8" (203 mm)	12-1/4" (311 mm)	.30

† Precision blade for use with small precision screws. Blade thickness of .028" expanding to .045".

‡ Blade thickness of .043" expanding to .085".

Note: K21 and K23 have pocket clips.

Phillips-Tip Screw-Holding Screwdrivers

- Positive gripping action holds and starts Phillips screws in awkward, hard-to-reach places.
- Blade separates to hold the fastener.
- Not designed for torquing or tightening.

Cat. No.	Overall Length	Weight (lbs.)
K14	5" (127 mm) with pocket clip	.05
K16	7" (178 mm)	.05
K19	9" (229 mm)	.05



K16

Offset Screwdrivers

Offset Screwdrivers

- Designed for confined hard-to-reach applications.
- Two tip sizes for added convenience.

Cat. No.	Tip Type	Tip Size	For Screw Nos.	Overall Length	Weight (lbs.)
V01	cabinet	3/16" (5 mm)	2 to 6	3" (76 mm)	.01
V03	cabinet	5/16" (8 mm)	8 to 12	5" (127 mm)	.11
V04	cabinet	3/8" (10 mm)	12 to 16	6" (152 mm)	.25
P340	Phillips	#3 & #4	N/A	6" (152 mm)	.20
V05	cabinet Phillips	1/4" (6 mm) #2	1/4" (6 mm) #2 Phillips	5" (127 mm)	.05

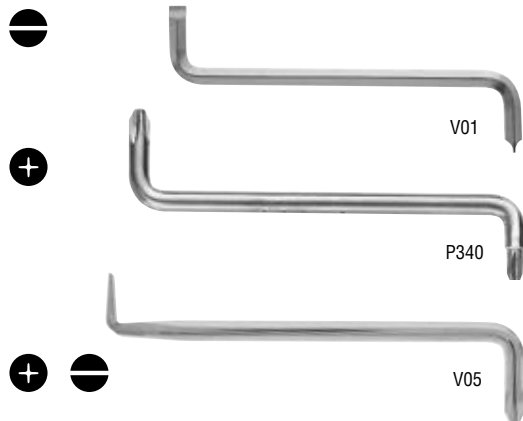

V01

P340

V05

All dimensions are in inches and (millimeters).



www.kleintools.com

See page 310 for additional information on warnings.

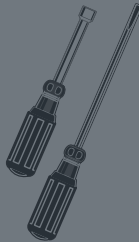

Specialty Driver Set

Reversible Impact-Driver Set

- Rugged, hand-impact driver turns rusted, frozen, or other stubborn screws.
- Can also be used with 3/8" square-drive impact sockets.
- Internal, spring-loaded, helical design transforms the impact of a hammer blow to up to 200 ft.-lbs. of shock torque.
- Easily reverses for tightening or loosening screws.
- Constructed of high-grade alloy steel that has been heat-treated for added strength.
- Reclosable, seal-tight vinyl pouch with hang-up grommet.



70220

Cat. No.	Description	Weight (lbs.)
70220	pouched impact-driver set with 3/8" * (89 mm) -square-drive fitting adapter for 5/16" (8 mm) hex bits, 4 assorted hex screwdriver bits 5/16" (8 mm) and 1/2" (38 mm) regular slotted tip, #2 and #4 Phillips-tip	2.15
Replacement Screwdriver Bits		
70229	replacement set of 5/16" (8 mm)-drive screwdriver bits (5/16" (8 mm) and 1/2" (38 mm) regular slotted tip, #2 and #4 Phillips-tip) packed in reclosable, seal-tight vinyl pouch	.25

Torque Screwdrivers

Torque Screwdriver Set

- Compact, easy to use set includes the Torque Screwdriver, a 6-piece bit set and a ruggedged case with foam inserts for a tight, organized fit.
- Increased usability and readability plus a wider torque range (5-40 in. lbs).
- Tri-lobular design with a textured finish for better grip.
- Lightweight, aluminum frame.
- N.I.S.T. traceable calibration certificate.

Cat. No.	Contains	Weight (lbs.)
57032	Set includes six 3-1/2" (89 mm) power drivers: #1 and #2 Phillips; 3/16" (5 mm) and 1/4" (6 mm) Slotted, and #1 and #2 Square	1.0



57032

Cushion-Grip Nut Driver Sets

Features:



Tip-Ident® quickly identifies nut driver and size.

Internal flanges provide solid, twist-resistant shaft anchor.

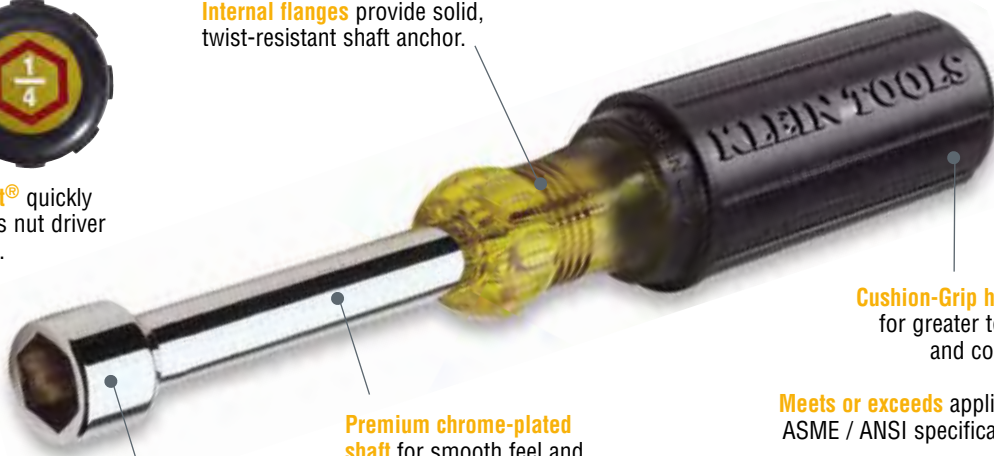

Cushion-Grip handle for greater torque and comfort.

Meets or exceeds applicable ASME / ANSI specifications.

Full hollow shafts facilitate work on stacked circuit boards or other long bolt applications.

Premium chrome-plated shaft for smooth feel and corrosion resistance.

Handle end is also color coded for easy identification.



All dimensions are in inches and (millimeters).



Cushion-Grip Nut Driver Sets

7-Piece Magnetic-Tip Hollow-Shaft* Nut Driver Set – 3" (76 mm) Shafts

- Full hollow-shaft for long bolts or studs.

Cat. No.	Set Contains	Weight (lbs.)
631M		1.50

Cat. No.	Color Code	Hex Size	Overall Length
630-3/16M*	black	3/16"	6-3/4" (171 mm)
630-1/4M	red	1/4"	6-3/4" (171 mm)
630-5/16M	yellow	5/16"	6-3/4" (171 mm)
630-11/32M	green	11/32"	6-3/4" (171 mm)
630-3/8M	blue	3/8"	6-3/4" (171 mm)
630-7/16M	brown	7/16"	7-5/16" (186 mm)
630-1/2M	red	1/2"	7-5/16" (186 mm)

*3/16" magnetic nut driver does not have hollow shaft



631M

7-Piece Nut Driver Set – 3" (76 mm) Shafts

Cat. No.	Set Contains	Weight (lbs.)
631		1.50

Cat. No.	Color Code	Hex Size	Overall Length
630-3/16	black	3/16"	6-3/4" (171 mm)
630-1/4	red	1/4"	6-3/4" (171 mm)
630-5/16	yellow	5/16"	6-3/4" (171 mm)
630-11/32	green	11/32"	6-3/4" (171 mm)
630-3/8	blue	3/8"	6-3/4" (171 mm)
630-7/16	brown	7/16"	7-5/16" (186 mm)
630-1/2	red	1/2"	7-5/16" (186 mm)

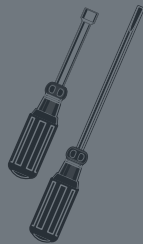

7-Piece Magnetic-Tip Hollow-Shaft* Nut Driver Set – 6" (152 mm) Shafts

- Full hollow shaft for long bolts or studs, with magnetic tip.

Cat. No.	Set Contains	Weight (lbs.)
647M		1.70

Cat. No.	Color Code	Hex Size	Overall Length
646-3/16M*	black	3/16"	9-3/4" (248 mm)
646-1/4M	red	1/4"	9-3/4" (248 mm)
646-5/16M	yellow	5/16"	9-3/4" (248 mm)
646-11/32M	green	11/32"	9-3/4" (248 mm)
646-3/8M	blue	3/8"	9-3/4" (248 mm)
646-7/16M	brown	7/16"	10-5/16" (262 mm)
646-1/2M	red	1/2"	10-5/16" (262 mm)

*3/16" magnetic nut driver does not have hollow shaft



647M



7-Piece Nut Driver Set – 6" (152 mm) Shafts

Cat. No.	Set Contains	Weight (lbs.)
647		1.70

Cat. No.	Color Code	Hex Size	Overall Length
646-3/16	black	3/16"	9-3/4" (248 mm)
646-1/4	red	1/4"	9-3/4" (248 mm)
646-5/16	yellow	5/16"	9-3/4" (248 mm)
646-11/32	green	11/32"	9-3/4" (248 mm)
646-3/8	blue	3/8"	9-3/4" (248 mm)
646-7/16	brown	7/16"	10-5/16" (262 mm)
646-1/2	red	1/2"	10-5/16" (262 mm)

All dimensions are in inches and (millimeters).



www.kleintools.com

See page 310 for additional information on warnings.



Cushion-Grip Nut Driver Sets

4-Piece Nut Driver Set

Additional Features:

- Standard length for most applications.

Cat. No.	Set Contains	Weight (lbs.)		
633		1.30		
Cat. No.	Color Code	Hex Size	Shaft Length	Overall Length
630-1/4	red	1/4"	3" (76 mm)	6-3/4" (171 mm)
630-5/16	yellow	5/16"	3" (76 mm)	6-3/4" (171 mm)
630-3/8	blue	3/8"	3" (76 mm)	6-3/4" (171 mm)
630-9/16	orange	9/16"	4" (102 mm)	9-3/8" (238 mm)



633

2-Piece Stubby Nut Driver Set – 1-1/2" (38 mm) Shafts

Additional Features:

- Full hollow-shaft for long bolt and studs applications.
- Stubby nut drivers allow for work in close quarters.
- Cat. No. 610M features magnetic tips.

Cat. No.	Set Contains	Weight (lbs.)	
610		.20	
Cat. No.	Color Code	Hex Size	Overall Length
610-1/4	red	1/4"	3-1/2" (89 mm)
610-5/16	yellow	5/16"	3-1/2" (89 mm)



610



Cat. No.	Set Contains	Weight (lbs.)	
610M		.20	
Cat. No.	Color Code	Hex Size	Overall Length
610-1/4M	red	1/4"	3-1/2" (89 mm)
610-5/16M	yellow	5/16"	3-1/2" (89 mm)

2-Piece Magnetic-Tip Hollow-Shaft Nut Driver Sets

Additional Features:

- General purpose selection of the most frequently used nut drivers.

Cat. No.	Set Contains	Weight (lbs.)		
630M		.40		
Cat. No.	Color Code	Hex Size	Shaft Length	Overall Length
630-1/4M	red	1/4"	3" (76 mm)	6-3/4" (171 mm)
630-5/16M	yellow	5/16"	3" (76 mm)	6-3/4" (171 mm)



630M

Cat. No.	Set Contains	Weight (lbs.)		
646M		.50		
Cat. No.	Color Code	Hex Size	Shaft Length	Overall Length
646-1/4M	red	1/4"	6" (152 mm)	9-3/4" (248 mm)
646-5/16M	yellow	5/16"	6" (152 mm)	9-3/4" (248 mm)

7-Piece Metric Nut Driver Set – 3" (76 mm) Shafts

Additional Features:

- Standard length for most long bolt and stud applications.

Cat. No.	Set Contains	Weight (lbs.)		
65160		1.50		
Cat. No.	Color Code	Hex Size Metric	Shaft Length	Overall Length
630-5mm	black	5 mm	3" (76 mm)	6-3/4" (171 mm)
630-5.5mm	brown	5.5 mm	3" (76 mm)	6-3/4" (171 mm)
630-6mm	red	6 mm	3" (76 mm)	6-3/4" (171 mm)
630-7mm	orange	7 mm	3" (76 mm)	6-3/4" (171 mm)
630-8mm	yellow	8 mm	3" (76 mm)	6-3/4" (171 mm)
630-9mm	green	9 mm	3" (76 mm)	6-3/4" (171 mm)
630-10mm	blue	10 mm	3" (76 mm)	6-3/4" (171 mm)



65160

All dimensions are in inches and (millimeters).



www.kleintools.com

See page 310 for additional information on warnings.

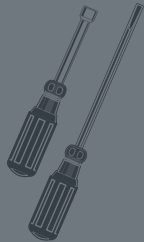

Cushion-Grip Nut Driver Sets

Switch Drive™ Handle Power Nut Driver Set **NEW!**

Additional Features:

- Allows for easy alternating between power tool and hand tool on job site.
- Quick-Release mechanism converts power tool accessory to hand tool in a snap.
- Includes Switch Drive™ handle and 3 nut driver sizes.
- Drivers are impact rated.



32701

Cat. No.	Hex Sizes	Nut Driver Length	Overall Length	Weight (lbs.)
32701	1/4", 5/16", 3/8"	2" (51 mm)	7.75" (197 mm)	.70

Refer to the power tool accessories and systems section for more information.

NOTE: Read and follow safety instructions in power tool owner's manual.

Cushion-Grip Nut Drivers

Stubby Nut Drivers – 1-1/2" (38 mm) Shafts

Additional Features:

- Full hollow-shaft for long bolt and studs applications.
- Stubby nut drivers allow for work in close quarters.



610-5/16

Cat. No.	Color Code	Hex Size	Shaft Length	Overall Length	Weight (lbs.)
610-1/4	red	1/4"	1-1/2" (38 mm)	3-1/2" (89 mm)	.10
610-5/16	yellow	5/16"	1-1/2" (38 mm)	3-1/2" (89 mm)	.10

Hollow-Shaft Nut Drivers – 3" (76 mm) Shafts

Additional Features:

- Standard length for most long bolt and stud applications.



630-11mm

Imperial

Cat. No.	Color Code	Hex Size	Shaft Length	Overall Length	Weight (lbs.)
630-3/16	black	3/16"	3" (76 mm)	6-3/4" (171 mm)	.20
630-1/4	red	1/4"	3" (76 mm)	6-3/4" (171 mm)	.20
630-5/16	yellow	5/16"	3" (76 mm)	6-3/4" (171 mm)	.20
630-11/32	green	11/32"	3" (76 mm)	6-3/4" (171 mm)	.20
630-3/8	blue	3/8"	3" (76 mm)	6-3/4" (171 mm)	.20
630-7/16	brown	7/16"	3" (76 mm)	7-5/16" (186 mm)	.25
630-1/2	red	1/2"	3" (76 mm)	7-5/16" (186 mm)	.25
630-9/16	orange	9/16"	4" (102 mm)	9-3/8" (238 mm)	.35
630-5/8	yellow	5/8"	4" (102 mm)	9-3/8" (238 mm)	.35

Refer to the insulated section for insulated nut drivers.

Metric

Cat. No.	Color Code	Hex Size Metric	Shaft Length	Overall Length	Weight (lbs.)
630-4mm	red	4 mm	3" (76 mm)	6-3/4" (171 mm)	.20
630-4.5mm	yellow	4.5 mm	3" (76 mm)	6-3/4" (171 mm)	.20
630-5mm	black	5 mm	3" (76 mm)	6-3/4" (171 mm)	.20
630-6mm	red	6 mm	3" (76 mm)	6-3/4" (171 mm)	.20
630-7mm	orange	7 mm	3" (76 mm)	6-3/4" (171 mm)	.20
630-8mm	yellow	8 mm	3" (76 mm)	6-3/4" (171 mm)	.20
630-10mm	blue	10 mm	3" (76 mm)	6-3/4" (171 mm)	.20
630-11mm	brown	11 mm	3" (76 mm)	7-5/16" (186 mm)	.20

All dimensions are in inches and (millimeters).



www.kleintools.com

See page 310 for additional information on warnings.

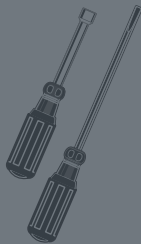

Cushion-Grip Nut Drivers Sets

Hollow-Shaft Nut Drivers – 6" (152 mm) Shafts

Additional Features:

- Reaches into deep recesses.
- Fits over extra-long bolts and studs.

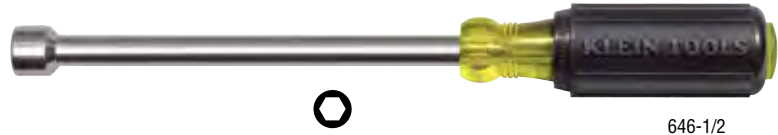

646-1/2

Cat. No.	Color Code	Hex Size	Shaft Length	Overall Length	Weight (lbs.)
646-3/16	black	3/16"	6" (152 mm)	9-3/4" (248 mm)	.25
646-1/4	red	1/4"	6" (152 mm)	9-3/4" (248 mm)	.25
646-5/16	yellow	5/16"	6" (152 mm)	9-3/4" (248 mm)	.25
646-11/32	green	11/32"	6" (152 mm)	9-3/4" (248 mm)	.25
646-3/8	blue	3/8"	6" (152 mm)	9-3/4" (248 mm)	.30

Cat. No.	Color Code	Hex Size	Shaft Length	Overall Length	Weight (lbs.)
646-7/16	brown	7/16"	6" (152 mm)	10-5/16" (262 mm)	.35
646-1/2	red	1/2"	6" (152 mm)	10-5/16" (262 mm)	.35
646-9/16	orange	9/16"	6" (152 mm)	11-3/8" (289 mm)	.40
646-5/8	yellow	5/8"	6" (152 mm)	11-3/8" (289 mm)	.40

Magnetic-Tip Hollow-Shaft* Nut Drivers

Additional Feature:

- Exclusive hollow shaft* design with Rare Earth magnetic tip features unobstructed pass-through, even on long bolts.

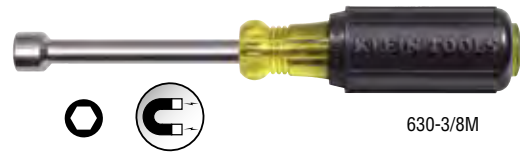

630-3/8M

Cat. No.	Color Code	Hex Size	Shaft Length	Overall Length	Weight (lbs.)
610-1/4M	red	1/4"	3" (76 mm)	1-1/2" (89 mm)	.10
610-5/16M	yellow	5/16"	3" (76 mm)	1-1/2" (89 mm)	.10
610-3/8M	blue	3/8"	3" (76 mm)	1-1/2" (89 mm)	.10
630-3/16M*	black	3/16"	3" (76 mm)	6-3/4" (171 mm)	.20
630-1/4M	red	1/4"	3" (76 mm)	6-3/4" (171 mm)	.20
630-5/16M	yellow	5/16"	3" (76 mm)	6-3/4" (171 mm)	.20
630-11/32M	green	11/32"	3" (76 mm)	6-3/4" (171 mm)	.20
630-3/8M	blue	3/8"	3" (76 mm)	6-3/4" (171 mm)	.20
630-7/16M	brown	7/16"	3" (76 mm)	7-5/16" (186 mm)	.25

Cat. No.	Color Code	Hex Size	Shaft Length	Overall Length	Weight (lbs.)
646-3/16M*	black	3/16"	6" (152 mm)	9-3/4" (248 mm)	.25
646-1/4M	red	1/4"	6" (152 mm)	9-3/4" (248 mm)	.25
646-5/16M	yellow	5/16"	6" (152 mm)	9-3/4" (248 mm)	.25
646-11/32M	green	11/32"	6" (152 mm)	9-3/4" (248 mm)	.25
646-3/8M	blue	3/8"	6" (152 mm)	9-3/4" (248mm)	.30
646-7/16M	brown	7/16"	6" (152 mm)	10-5/16" (262 mm)	.35
646-1/2M	red	1/2"	6" (152 mm)	10-5/16" (262 mm)	.35
618-1/4M	red	1/4"	18" (457 mm)	21-3/4" (552 mm)	.50
618-5/16M	yellow	5/16"	18" (457 mm)	21-3/4" (552 mm)	.50

*3/16" magnetic nut driver does not have a hollow shaft.

Drive-A-Matic Nut Driver



632

Additional Features:

- Automatically fits 15 different nut and screw sizes.
- Hex head adjusts to the proper size as you turn it.
- Will drive or loosen hex nuts from 1/4" (6 mm) to 7/16" (11 mm), hex-head screws from No. 6 to 1/4" (6 mm), and socket-head cap screws from No. 8 to 5/16" (8 mm).

Cat. No.	Overall Length	Weight (lbs.)
632	7" (178 mm) when open, 6-3/4" (171 mm) when closed	.35

Coated Hollow-Shaft Nut Drivers



640-1/2

Additional Features:

- Entire shaft plastic coated for circuit protection only. NOT INSULATED.
- Special plastic coating resists cutting, cracking and chipping.
- Thin coating permits use in confined areas.

Cat. No.	Color Code	Hex Size	Shaft Length	Overall Length	Weight (lbs.)
640-3/16	black	3/16"	3" (76 mm)	6-3/4" (171 mm)	.25
640-1/4	red	1/4"	3" (76 mm)	6-3/4" (171 mm)	.25
640-5/16	yellow	5/16"	3" (76 mm)	6-3/4" (171 mm)	.25
640-3/8	blue	3/8"	3" (76 mm)	6-3/4" (171 mm)	.25
640-7/16	brown	7/16"	3" (76 mm)	7-5/16" (186 mm)	.30
640-1/2	red	1/2"	3" (76 mm)	7-5/16" (186 mm)	.25
640-9/16	orange	9/16"	4" (102 mm)	9-3/8" (238 mm)	.40
640-5/8	yellow	5/8"	4" (102 mm)	9-3/8" (238 mm)	.40

⚠WARNING: NOT insulated. Coating is intended for protection of circuits only.

All dimensions are in inches and (millimeters).



www.kleintools.com

See page 310 for additional information on warnings.

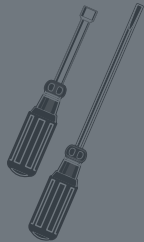

Plastic-Handle, Hollow-Shaft Nut Driver Sets

Features:

Meets or exceeds applicable ASME / ANSI specifications.

Smooth Comfordome® handles fit the palm of the hand comfortably.

Chrome-plated shaft helps prevent corrosion.

Hollow shafts facilitate work on stacked circuit boards or other long bolt applications.

Internal flanges provide solid, twist-resistant shaft anchor.

Handles are color-coded for easy identification.



7-Piece Nut Driver Set – 3" (76 mm) Shafts

Additional Features:

- Set contains seven hollow-shaft nut drivers in the most popular hex sizes.
- Convenient vinyl pouch hangs up or rolls up.

Cat. No.	Set Contains					Weight (lbs.)
K7						1.15
Cat. No.	Handle Color	Hex Size	Shaft Length	Overall Length		
S6	black	3/16"	3" (76 mm)	6-5/8" (168 mm)		
S8	red	1/4"	3" (76 mm)	6-5/8" (168 mm)		
S10	amber	5/16"	3" (76 mm)	6-5/8" (168 mm)		
S11	green	11/32"	3" (76 mm)	6-5/8" (168 mm)		
S12	blue	3/8"	3" (76 mm)	6-5/8" (168 mm)		
S14	brown	7/16"	3" (76 mm)	7" (178 mm)		
S16	red	1/2"	3" (76 mm)	7" (178 mm)		



K7

7-Piece Nut Driver Set – 6" (152 mm) Shafts

Additional Feature:

- Contains seven 6"-shaft nut drivers that reach into deep recesses.

Cat. No.	Set Contains					Weight (lbs.)
89904						1.15
Cat. No.	Handle Color	Hex Size	Shaft Length	Overall Length		
S66	black	3/16"	6" (152 mm)	9-5/8" (244 mm)		
S86	red	1/4"	6" (152 mm)	9-5/8" (244 mm)		
S106	amber	5/16"	6" (152 mm)	9-5/8" (244 mm)		
S116	green	11/32"	6" (152 mm)	9-5/8" (244 mm)		
S126	blue	3/8"	6" (152 mm)	9-5/8" (244 mm)		
S146	brown	7/16"	6" (152 mm)	10" (254 mm)		
S166	red	1/2"	6" (152 mm)	10" (254 mm)		



89904

All dimensions are in inches and (millimeters).



www.kleintools.com

See page 310 for additional information on warnings.



Plastic-Handle, Hollow-Shaft Nut Driver Sets

10-Piece Metric Nut Driver Set With Stand – 3" (76 mm) Shafts

Additional Features:

- White enameled metal stand holds all ten 3"-shaft metric nut drivers.
- Identification label makes individual size selection easy.

Cat. No.	Set Contains	Weight (lbs.)	
70200		1.85	
Cat. No.	Hex Size	Shaft Length	Overall Length
70204	4 mm	3" (76 mm)	6-5/8" (168 mm)
70245	4.5 mm	3" (76 mm)	6-5/8" (168 mm)
70205	5 mm	3" (76 mm)	6-5/8" (168 mm)
70255	5.5 mm	3" (76 mm)	6-5/8" (168 mm)
70206	6 mm	3" (76 mm)	6-5/8" (168 mm)
70207	7 mm	3" (76 mm)	6-5/8" (168 mm)
70208	8 mm	3" (76 mm)	6-5/8" (168 mm)
70209	9 mm	3" (76 mm)	6-5/8" (168 mm)
70210	10 mm	3" (76 mm)	7" (178 mm)
70211	11 mm	3" (76 mm)	7" (178 mm)



70200

Plastic-Handle Hollow Shaft Nut Drivers

Stubby Nut Drivers – 1-1/2" (38 mm) Shafts

Additional Feature:

- For work in close quarters.

Cat. No.	Handle Color	Hex Size	Shaft Length	Overall Length	Weight (lbs.)
SS8	red	1/4"	1-1/2" (38 mm)	3-3/4" (95 mm)	.15
SS10	amber	5/16"	1-1/2" (38 mm)	3-3/4" (95 mm)	.15
SS12	blue	3/8"	1-1/2" (38 mm)	3-3/4" (95 mm)	.15



SS10

Hollow-Shaft Nut Drivers – 3" (76 mm) & 4" (102 mm) Shafts



S10

Additional Features:

- Standard length works for most applications.
- Fits over long bolts and studs.

Cat. No.	Handle Color	Hex Size	Shaft Length	Overall Length	Weight (lbs.)
S5	amber	5/32"	3" (76 mm)	6-1/2" (165 mm)	.10
S6	black	3/16"	3" (76 mm)	6-5/8" (168 mm)	.10
S7	brown	7/32"	3" (76 mm)	6-5/8" (168 mm)	.10
S8	red	1/4"	3" (76 mm)	6-5/8" (168 mm)	.15
S9	orange	9/32"	3" (76 mm)	6-5/8" (168 mm)	.15
S10	amber	5/16"	3" (76 mm)	6-5/8" (168 mm)	.15
S11	green	11/32"	3" (76 mm)	6-5/8" (168 mm)	.15
S12	blue	3/8"	3" (76 mm)	6-5/8" (168 mm)	.15
S14	brown	7/16"	3" (76 mm)	7" (178 mm)	.20
S16	red	1/2"	3" (76 mm)	7" (178 mm)	.20
S18	red	9/16"	4" (102 mm)	8-1/2" (216 mm)	.30
S20	red	5/8"	4" (102 mm)	8-1/2" (216 mm)	.30

Metric Nut Drivers – 3" (76 mm) Shafts



70209

Additional Features:

- Standard length works for most applications.
- Fits over long bolts and studs.

Cat. No.	Handle Color	Hex Size	Shaft Length	Overall Length	Weight (lbs.)
70204	black	4 mm	3" (76 mm)	6-5/8" (168 mm)	.10
70245	black	4.5 mm	3" (76 mm)	6-5/8" (168 mm)	.10
70205	black	5 mm	3" (76 mm)	6-5/8" (168 mm)	.15
70255	black	5.5 mm	3" (76 mm)	6-5/8" (168 mm)	.15
70206	black	6 mm	3" (76 mm)	6-5/8" (168 mm)	.15
70207	black	7 mm	3" (76 mm)	6-5/8" (168 mm)	.15
70208	black	8 mm	3" (76 mm)	6-5/8" (168 mm)	.15
70209	black	9 mm	3" (76 mm)	6-5/8" (168 mm)	.15
70210	black	10 mm	3" (76 mm)	7" (178 mm)	.15
70211	black	11 mm	3" (76 mm)	7" (178 mm)	.20

All dimensions are in inches and (millimeters).



www.kleintools.com

See page 310 for additional information on warnings.

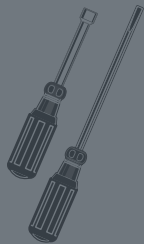

Plastic-Handle, Nut Drivers

Nut Drivers – 6" (152 mm) Shafts



Additional Features:

- Reaches into deep recesses.
- Fits over extra-long bolts and studs.

S86

Cat. No.	Handle Color	Hex Size	Shaft Length	Overall Length	Weight (lbs.)
S66	black	3/16"	6" (152 mm)	9-5/8" (244 mm)	.15
S86	red	1/4"	6" (152 mm)	9-5/8" (244 mm)	.15
S106	amber	5/16"	6" (152 mm)	9-5/8" (244 mm)	.15
S116	green	11/32"	6" (152 mm)	9-5/8" (244 mm)	.15
S126	blue	3/8"	6" (152 mm)	9-5/8" (244 mm)	.15
S146	brown	7/16"	6" (152 mm)	10" (254 mm)	.20

Magnetic Nut Drivers – Solid Shafts



Additional Feature:

- Powerful nut-holding magnet built into solid shaft.

S106M

Cat. No.	Handle Color	Hex Size	Shaft Length	Overall Length	Weight (lbs.)
S8M	red	1/4"	3" (76 mm)	6-5/8" (168 mm)	.15
S10M	amber	5/16"	3" (76 mm)	6-5/8" (168 mm)	.15
S86M	red	1/4"	6" (152 mm)	9-5/8" (244 mm)	.15
S106M	amber	5/16"	6" (152 mm)	9-5/8" (244 mm)	.15
S126M	blue	3/8"	6" (152 mm)	9-5/8" (244 mm)	.15
S818M	red	1/4"	18" (457 mm)	21-5/8" (549 mm)	.25
S1018M	amber	5/16"	18" (457 mm)	21-5/8" (549 mm)	.25

Super-Long Nut Drivers – 18" (457 mm) Shafts



Additional Features:

- Heavy-duty, long-reach nut drivers.
- Ideal for reaching into walls and other hard-to-reach places where added length is necessary.
- Available in magnetic and non-magnetic tips.

S1018

Cat. No.	Handle Color	Type	Hex Size	Shaft Length	Overall Length	Weight (lbs.)
S818	red	standard	1/4"	18" (457 mm)	21-5/8" (549 mm)	.25
S1018	amber	standard	5/16"	18" (457 mm)	21-5/8" (549 mm)	.25
S818M	red	magnetic	1/4"	18" (457 mm)	21-5/8" (549 mm)	.25
S1018M	amber	magnetic	5/16"	18" (457 mm)	21-5/8" (549 mm)	.25

Tapping Tools and Awls

Cushion-Grip Multi-Bit Tap Tool Driver **NEW!**

- Increases job speed by combining taps and drivers in one tool
- Six common tap sizes (6-32, 8-32, 10-32, 10-24, 12-24, 1/4-20)
- Each tap size rethreads to next larger size if threads are stripped.



32517

Cat. No.	Shaft Length	Overall Length	Weight (lbs.)
32517	4" (100 mm)	7-3/4" (200 mm)	0.50

Replacement Tap	Weight (lbs.)
32518 Tap sizes 6-32, 8-32, 10-32, 10-24, 12-24, 1/4-20	.05



Cushion-Grip Triple Taps and 6-in-1 Tap Tool

- Quickly forms new threads, re-forms burred threads, and cleans out plaster obstructions.
- Each tap size rethreads to next larger size if threads are stripped.



626

Cat. No.	Tap Sizes	Overall Length	Weight (lbs.)
623-20	Triple Tap 10-24, 12-24, 1/4-20	7-3/4" (197 mm)	.25
623-24	Triple Tap 6-32, 8-32, 10-24	7-3/4" (197 mm)	.25
626	6-in-1 Tap 6-32, 8-32, 10-32, 10-24, 12-24, 1/4-20	7-3/4" (197 mm)	.25

Replacement Taps	Weight (lbs.)
628-20 10-24, 12-24, 1/4-20	replacement for 623-20, 626
626-24 6-32, 8-32, 10-24	replacement for 623-24
626-32 6-32, 8-32, 10-32	replacement for 623-32, 626

Drill Tap Set **NEW!**

- For aluminum, brass, copper, plastic, and mild steel.
- 1/4" hex for easier application with quick connect.
- Set of six tap sizes plus two extra of the smallest taps.
- For use on up to 10 gauge metal.
- Replacement taps are available.

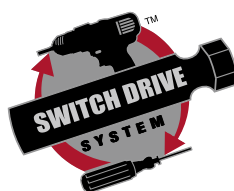

Cat. No.	Tap Sizes Included	Weight (lbs.)
32217	6-32 (2), 8-32 (2) 10-24, 10-32, 12-24, 1/4-20	1.0

NOTE: Read and follow safety instructions in power tool owner's manual. 32217

All dimensions are in inches and (millimeters).



www.kleintools.com

See page 310 for additional information on warnings.

Tapping Tools and Awls

6-in-1 Tapping Tool



- Quickly forms new threads, re-forms burred threads, and cleans out plaster obstructions.
- Each tap size rethreads to next larger size if threads are stripped.
- Two high-carbon steel taps are secured in reversible holder.

627-20

Cat. No.	Tap Sizes	Overall Length	Weight (lbs.)
627-20	6-32, 8-32, 10-32, 10-24, 12-24, 1/4-20	7-5/8" (194 mm)	0.35

Replacement Taps

626-32	10-32, 8-32, 6-32
628-20	10-24, 12-24, 1/4-20

Triple Taps



- Quickly forms new threads, re-forms burred threads, and cleans out plaster obstructions.
- Each tap size rethreads to next larger size if threads are stripped.

625-24

Cat. No.	Tap Sizes	Color Code	Overall Length	Weight (lbs.)
625-24	6-32, 8-32, 10-24	blue	7-1/8" (181 mm)	0.20
625-32	6-32, 8-32, 10-32	orange	7-1/8" (181 mm)	0.20

Replacement Taps

626-24	for Cat. No. 625-24
626-32	for Cat. No. 625-32

Cushion-Grip Scratch Awl

- Professional, heavy-duty, hard-pointed awl.
- Scribes metal, starts screw holes, performs a variety of piercing and punching jobs.
- Rigid, chrome-plated, heat-treated, tempered-steel shank has full reinforcing bolster at handle for extra strength and impact reinforcement.
- Cat. No. 650DD has plated metal strike cap to protect handle from hammer blows and is engineered, manufactured and tested for prying, chiseling and punching.

NEW!



650DD



Cat. No. 650 only

Cat. No.	Blade Length	Overall Length	Weight (lbs.)
650	3-1/2" (89 mm)	7-7/8" (200 mm)	.25
650DD	3-1/2" (89 mm)	7-7/8" (200 mm)	.30 NEW!

Steel Scratch Awl

- One-piece forged-steel blade and bolstered shank.
- Heat treated for long life.
- Well-balanced for top efficiency during use.
- Black finish for rust resistance.



66385

Cat. No.	Blade Length	Overall Length	Weight (lbs.)
66385	3-1/2" (89 mm)	7" (178 mm)	.30

Cushion-Grip Spring Tools

Spring Tool

- Installs or removes small-diameter coil springs on motors, brake shoes, headlights, relays, installing recessed can lighting, solenoids, and hundreds of other applications.
- Great for rod and leaf springs.
- Unique C-tip prevents spring slippage.



ST4

Cat. No.	Shank Length	Overall Length	Weight (lbs.)
ST4	4" (102 mm)	7-3/4" (197mm)	.17
ST6	6" (152 mm)	9-3/4" (248 mm)	.19

2-Piece Recessed Can Light Tool Set

- Contains the two tools needed for finishing can light installations in record time.
- Long reach, spring tool (Cat. No. ST6) makes attaching difficult springs easy.
- Compact, stubby nut driver (Cat. No. 610-1/4) even fits in smaller cans to tighten hard to reach ceiling height adjustment screws.



65020

Cat. No.	Set Contains	Weight (lbs.)
65020		.36

Cat. No.	Description	Shank Length	Overall Length
ST6	6" (152 mm) spring tool	6" (152 mm)	9-3/4" (248 mm)
610-1/4	1/4" (6 mm) stubby nut driver	1-1/2" (38 mm)	3-1/2" (89 mm)

All dimensions are in inches and (millimeters).



www.kleintools.com

See page 310 for additional information on warnings.