



Catalog Number: A-48P36
Item Description: STEEL PANELS
UPC Code: 784572183155

Brand Name: Milbank
Type: Panel for Mounting Electronic Controls
Application: Enclosure Accessory
Material: Steel
Shape: Rectangle
Color: White
Mounting: Stud Mount



Utility requirements may vary. Always consult the serving utility for their requirements prior to ordering or installing this equipment. This product must always be installed by a licensed electrician. Installation of this equipment may require local electrical inspector approval.

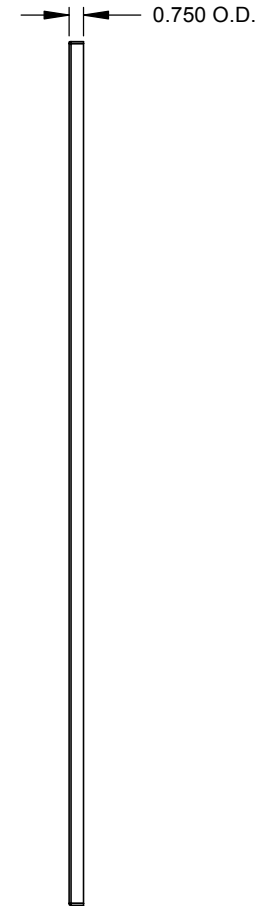
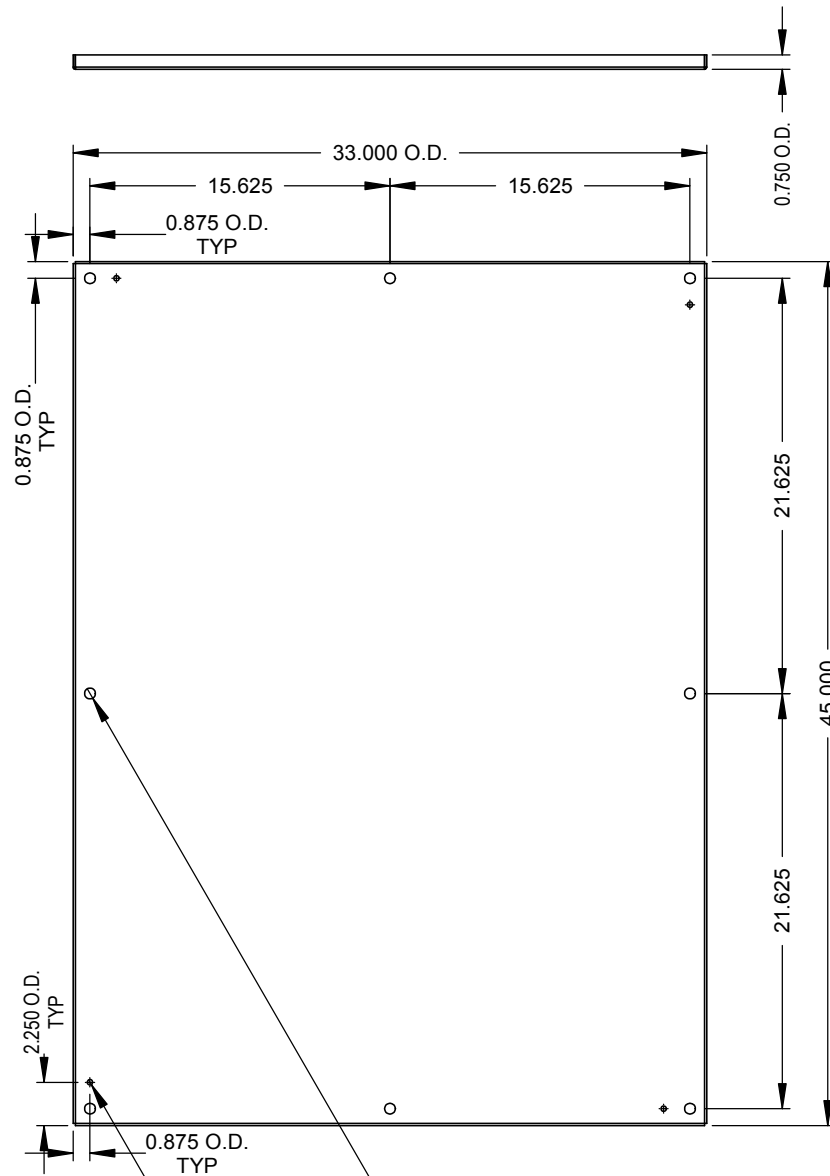

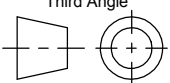

$\phi 0.563$ MOUNTING HOLE
8 PLACES

$\phi 0.281$ GROUND HOLE
4 PLACES

Material:	12 GA.	 MILBANK ENERGY AT WORK General Offices: Kansas City, MO	Title:	PANEL 48 x 36 - ENCLOSURE
Finish:	PAINTED WHITE		Catalog No.:	A-48P36
Tolerances: Unless Specified Otherwise X.X ±.1 X.XX ±.03 X.XXX ±.015 X° ±2°		Third Angle  Projection	Ref:	
Scale:	NTS		Checked By:	Drawing No.:
Drawn By:	AJS	Approved By:	Date:	5/21/14 Sheet 1 of 2

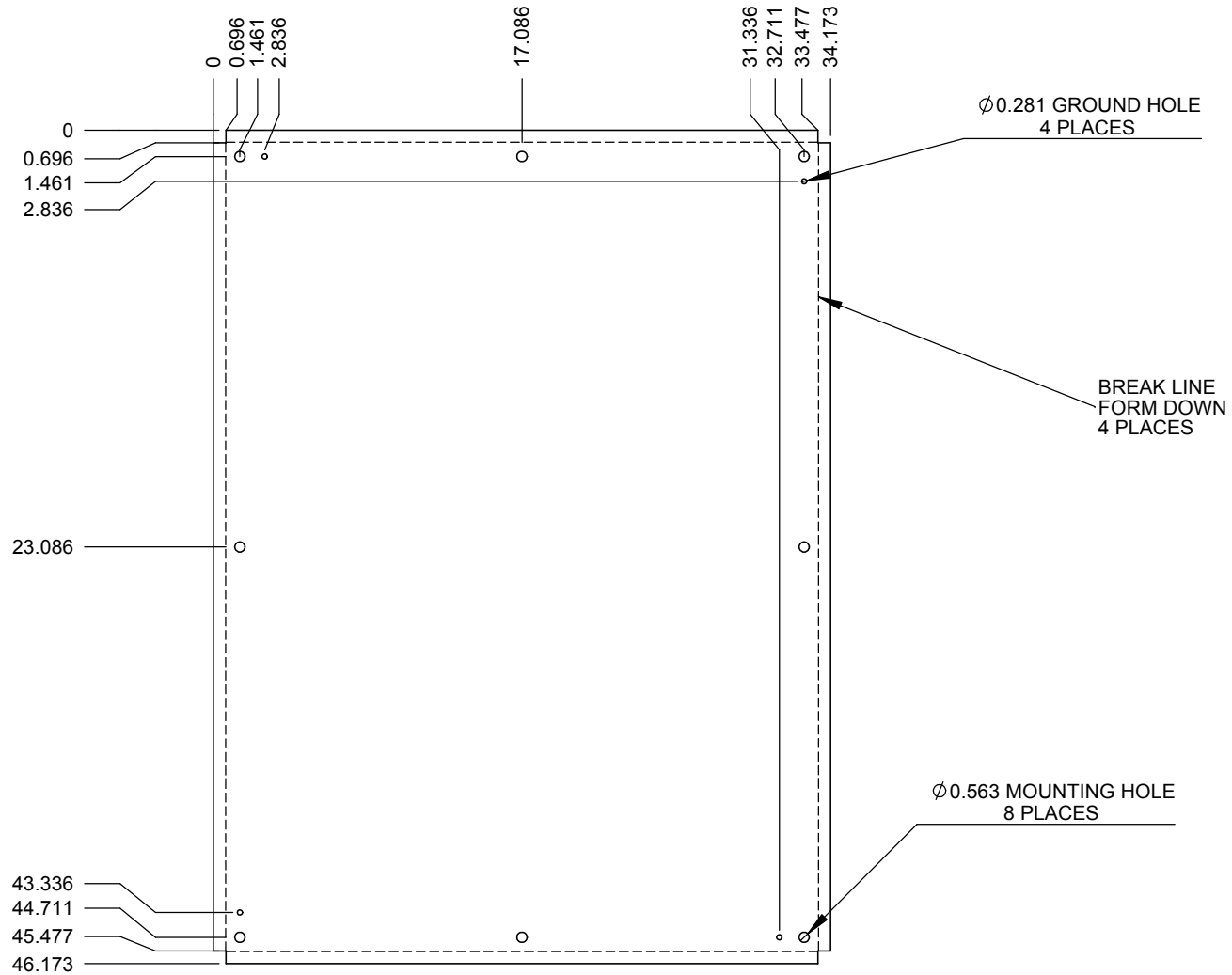
**	5/21/14	FIRST RELEASE	AJS			
----	---------	---------------	-----	--	--	--

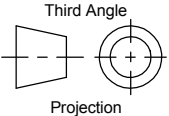

Material:	12 GA.	 MILBANK General Offices: <small>ENERGY AT WORK</small> Kansas City, MO	
Finish:	PAINTED WHITE		
Tolerances: Unless Specified Otherwise X.X ±.1 X.XX ±.03 X.XXX ±.015 X* ±2°		Title:	PANEL 48 x 36 - ENCLOSURE
 Third Angle Projection		Catalog No.:	A-48P36
Scale:		Checked By:	Drawing No.:
Drawn By:		Approved By:	Date:
			1012357 5/21/14 Sheet 2 of 2

**	5/21/14	FIRST RELEASE	AJS			
----	---------	---------------	-----	--	--	--



Catalog Number: A-48P36
Item Description: STEEL PANELS
UPC Code: 784572183155

Brand Name: Milbank
Type: Panel for Mounting Electronic Controls
Application: Enclosure Accessory
Material: Steel
Shape: Rectangle
Color: White
Mounting: Stud Mount



Utility requirements may vary. Always consult the serving utility for their requirements prior to ordering or installing this equipment. This product must always be installed by a licensed electrician. Installation of this equipment may require local electrical inspector approval.

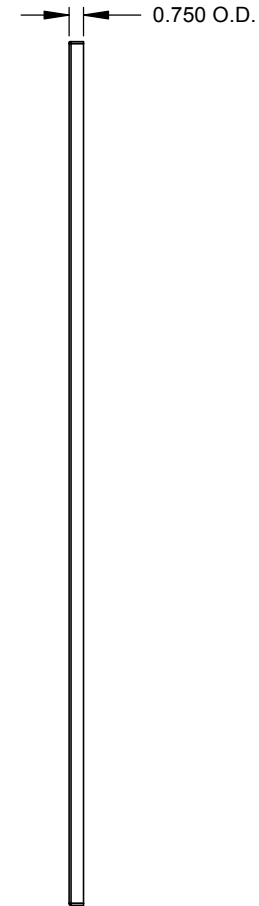
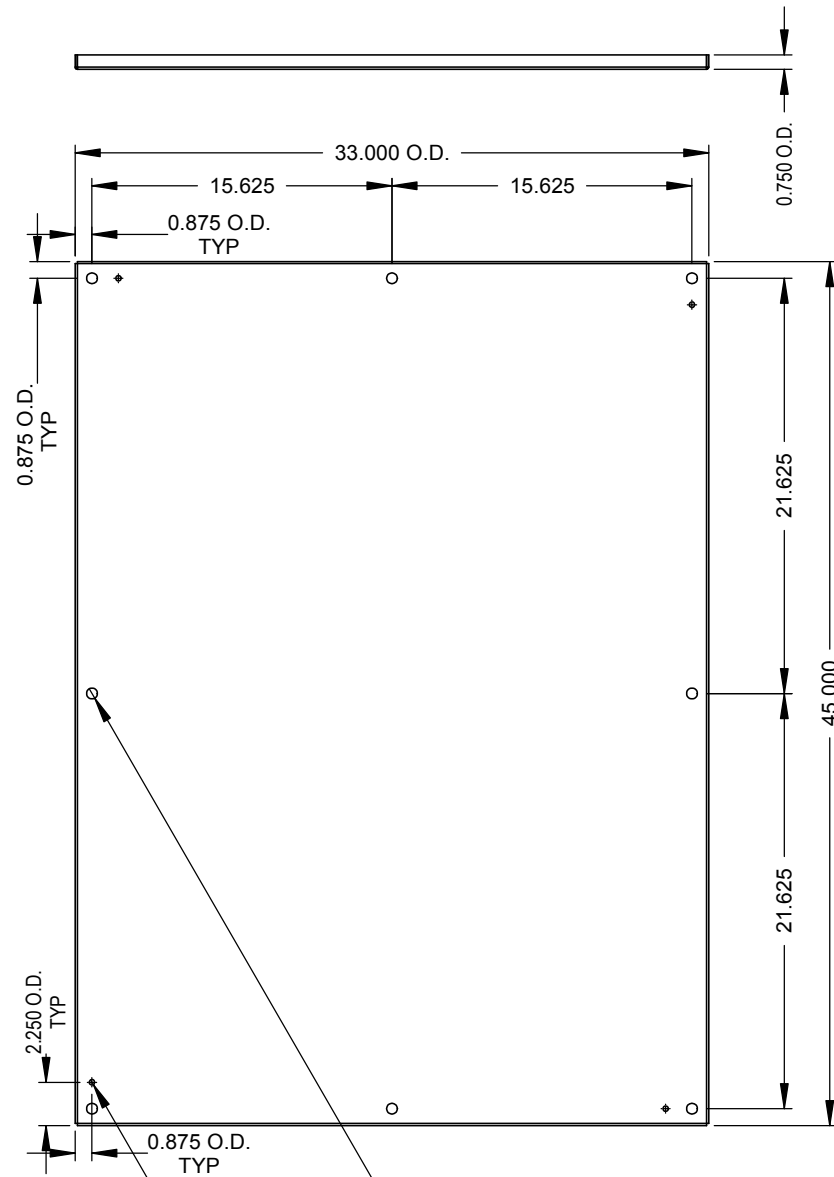

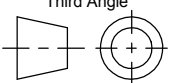

$\phi 0.563$ MOUNTING HOLE
8 PLACES

$\phi 0.281$ GROUND HOLE
4 PLACES

Material:	12 GA.	 MILBANK <small>ENERGY AT WORK</small>	General Offices: Kansas City, MO		
Finish:	PAINTED WHITE		Title:	PANEL 48 x 36 - ENCLOSURE	
Tolerances: Unless Specified Otherwise X.X ±.1 X.XX ±.03 X.XXX ±.015 X° ±2°		Third Angle  Projection	Catalog No.:	A-48P36	
Scale:	NTS		Ref:		
Drawn By:	AJS	Checked By:		Drawing No.:	1012357
		Approved By:		Date:	5/21/14
				Sheet	1 of 2

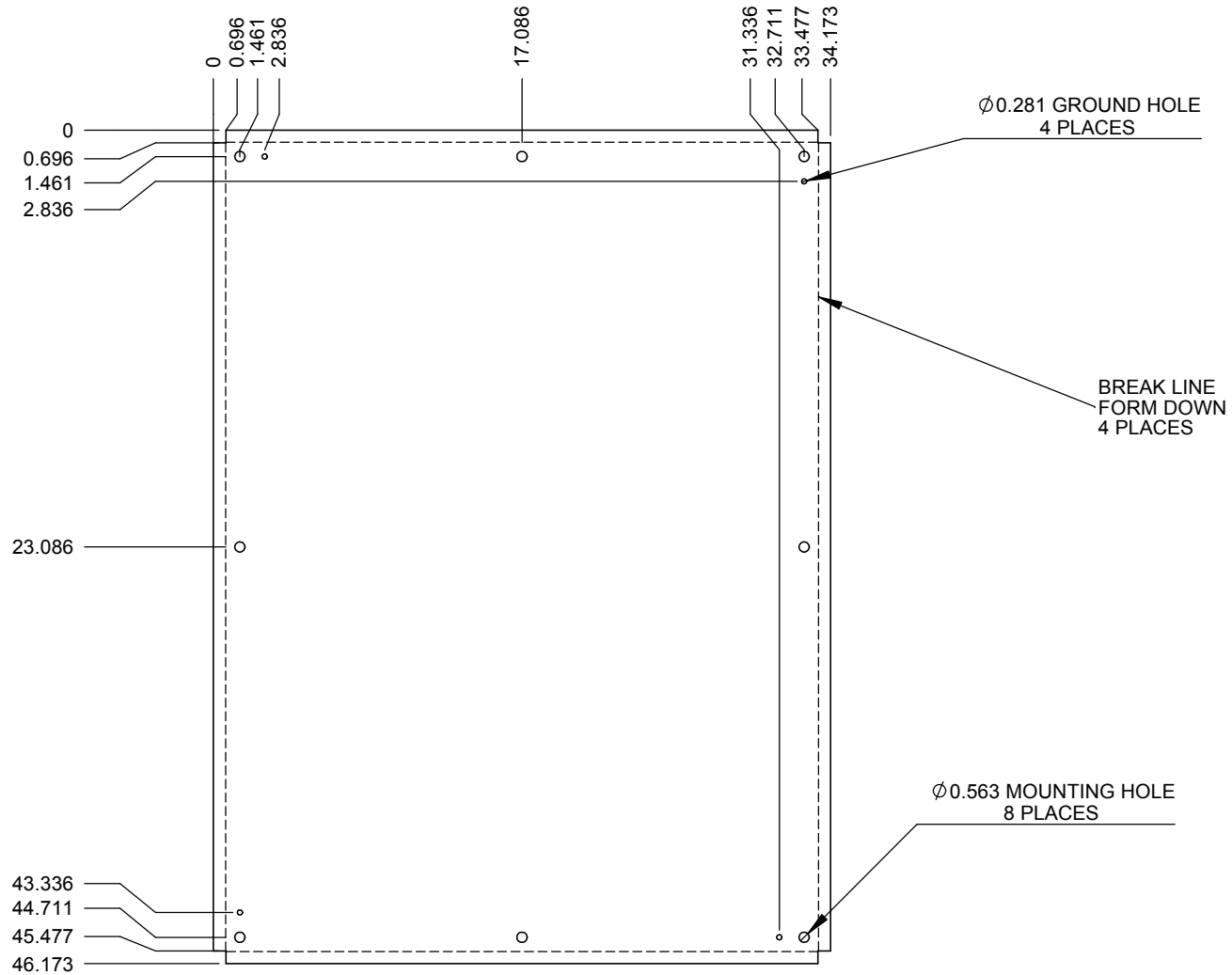
**	5/21/14	FIRST RELEASE	AJS			
----	---------	---------------	-----	--	--	--

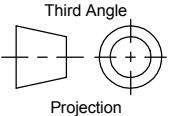

Material:	12 GA.	 MILBANK General Offices: <small>ENERGY AT WORK</small> Kansas City, MO		
Finish:	PAINTED WHITE			
Tolerances: Unless Specified Otherwise X.X ±.1 X.XX ±.03 X.XXX ±.015 X* ±2°		Title:	PANEL 48 x 36 - ENCLOSURE	
 Third Angle Projection		Catalog No.:	A-48P36	
Scale:		NTS	Ref:	
Checked By:			Drawing No.:	1012357
Drawn By:		AJS	Date:	5/21/14
Approved By:			Sheet	2 of 2

**	5/21/14	FIRST RELEASE	AJS			
----	---------	---------------	-----	--	--	--