

Hardware and Threaded Components

E145 Hex Nut



CAT. NO.	SIZES (IN.)	WT. LBS./C
E145 1/4	1/4-20	1.2
E145 5/16	5/16-18	2.0
E145 3/8	3/8-16	3.2
E145 1/2	1/2-13	5.0
E145 3/8	3/8-11	9.0

Standard finish: Galv-Krom® unless otherwise specified.

E146 Square Nut



CAT. NO.	SIZES (IN.)	WT. LBS./C
E146 1/4	1/4-20	1.00
E146 5/16	5/16-18	2.40
E146 3/8	3/8-16	2.37
E146 1/2	1/2-13	6.00
E146 5/8	5/8-11	11.00

Standard finish: Galv-Krom® unless otherwise specified.

54, E149 Round Head Machine Screw — Less Nut

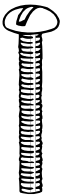

CAT. NO.	SIZES (IN.)	WT. LBS./C
54 571P	1/4-20 x 1/2	1.00
54-572-P	1/4-20 x 3/4	1.25
54-574	1/4-20 x 1 1/4	1.76
54-576	1/4-20 x 2	2.54
E149 3/8 1 1/4	3/8-16 x 3/4	3.45

Standard finish: Galv-Krom® unless otherwise specified.

E147 Flat Steel Washer



CAT. NO.	SIZES (IN.)	WT. LBS./C
E147 1/4	1/4	.67
E147 5/16	5/16	1.20
E147 3/8	3/8	2.00
E147 1/2	1/2	3.85
E147 5/8	5/8	7.70
E147 3/4	3/4	9.00

Standard finish: Galv-Krom® unless otherwise specified.

E148 Lock Washer



CAT. NO.	SIZES (IN.)	WT. LBS./C
E148 1/4	1/4	.259
E148 5/16	5/16	.550
E148 3/8	3/8	.630
E148 1/2	1/2	1.436
E148 5/8	5/8	2.587
E148 3/4	3/4	4.293

Standard finish: Galv-Krom® unless otherwise specified.

AB241 Square Washer

CAT. NO.	DIMENSIONS (IN.)		WT. LBS./C
	SIZE	THICKNESS	
AB241 1/4	1/4	1/8	8.10
AB241 5/16	5/16	1/8	8.00
AB241 3/8	3/8	3/16	11.50
AB241 1/2	1/2	1/4	14.36
AB241 5/8	5/8	1/4	13.50
AB241 3/4	3/4	1/4	12.50
AB241 7/8	7/8	1/4	13.00

Standard finish: Galv-Krom® unless otherwise specified.

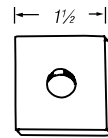

Located Square Washers

CAT. NO.	BOLT SIZE (IN.)	STD. CTN.
AB-241L-1/4	1/4	100
AB-241L-5/16	5/16	100
AB-241L-3/8	3/8	100
AB-241L-1/2	1/2	100
AB-241L-5/8	5/8	100

GoldGalv® is standard finish.

Add "EG" suffix for SilverGalv®.

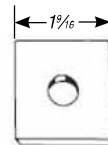

H-550 Swivel Beam Clamp

One-piece malleable-iron casting. Attaches to beam flanges up to 3/4" thickness.

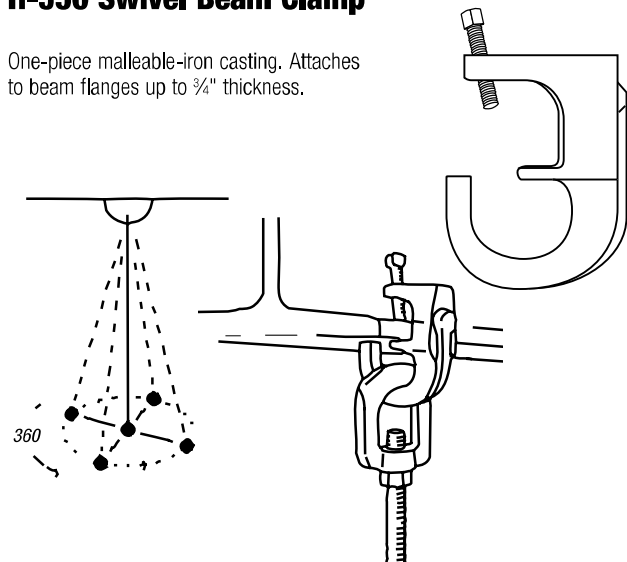

CAT. NO.	DESCRIPTION	WT. LBS./C
H-550	Max. load rating 500 lbs. with a safety factor of 3.	33

Galv-Krom® finish.

Hardware and Threaded Components

E145 Hex Nut



CAT. NO.	SIZES (IN.)	WT. LBS./C
E145 1/4	1/4-20	1.2
E145 5/16	5/16-18	2.0
E145 3/8	3/8-16	3.2
E145 1/2	1/2-13	5.0
E145 3/8	5/8-11	9.0

Standard finish: Galv-Krom® unless otherwise specified.

E146 Square Nut



CAT. NO.	SIZES (IN.)	WT. LBS./C
E146 1/4	1/4-20	1.00
E146 5/16	5/16-18	2.40
E146 3/8	3/8-16	2.37
E146 1/2	1/2-13	6.00
E146 5/8	5/8-11	11.00

Standard finish: Galv-Krom® unless otherwise specified.

54, E149 Round Head Machine Screw — Less Nut

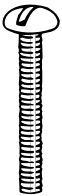

CAT. NO.	SIZES (IN.)	WT. LBS./C
54 571P	1/4-20 x 1/2	1.00
54-572-P	1/4-20 x 3/4	1.25
54-574	1/4-20 x 1 1/4	1.76
54-576	1/4-20 x 2	2.54
E149 3/8 1 1/4	3/8-16 x 3/4	3.45

Standard finish: Galv-Krom® unless otherwise specified.

E147 Flat Steel Washer



CAT. NO.	SIZES (IN.)	WT. LBS./C
E147 1/4	1/4	.67
E147 5/16	5/16	1.20
E147 3/8	3/8	2.00
E147 1/2	1/2	3.85
E147 5/8	5/8	7.70
E147 3/4	3/4	9.00

Standard finish: Galv-Krom® unless otherwise specified.

E148 Lock Washer



CAT. NO.	SIZES (IN.)	WT. LBS./C
E148 1/4	1/4	.259
E148 5/16	5/16	.550
E148 3/8	3/8	.630
E148 1/2	1/2	1.436
E148 5/8	5/8	2.587
E148 3/4	3/4	4.293

Standard finish: Galv-Krom® unless otherwise specified.

AB241 Square Washer

CAT. NO.	DIMENSIONS (IN.)		WT. LBS./C
	SIZE	THICKNESS	
AB241 1/4	1/4	1/8	8.10
AB241 5/16	5/16	1/8	8.00
AB241 3/8	3/8	3/16	11.50
AB241 1/2	1/2	1/4	14.36
AB241 5/8	5/8	1/4	13.50
AB241 3/4	3/4	1/4	12.50
AB241 7/8	7/8	1/4	13.00

Standard finish: Galv-Krom® unless otherwise specified.

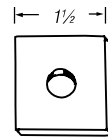

Located Square Washers

CAT. NO.	BOLT SIZE (IN.)	STD. CTN.
AB-241L-1/4	1/4	100
AB-241L-5/16	5/16	100
AB-241L-3/8	3/8	100
AB-241L-1/2	1/2	100
AB-241L-5/8	5/8	100

GoldGalv® is standard finish.

Add "EG" suffix for SilverGalv®.

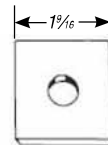

H-550 Swivel Beam Clamp

One-piece malleable-iron casting. Attaches to beam flanges up to 3/4" thickness.

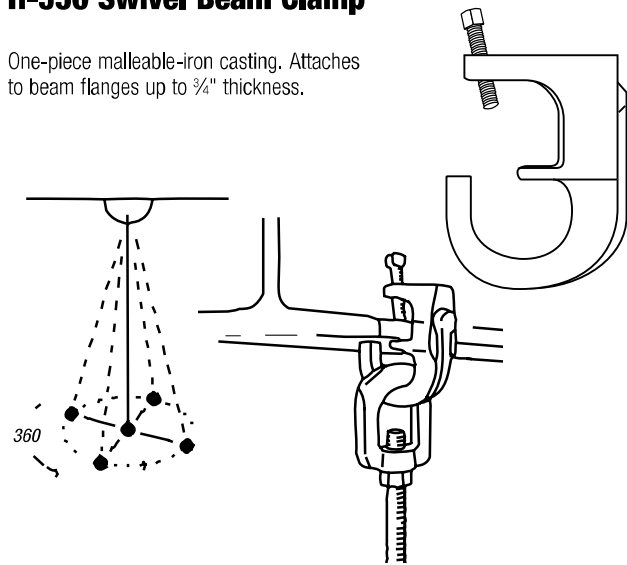

CAT. NO.	DESCRIPTION	WT. LBS./C
H-550	Max. load rating 500 lbs. with a safety factor of 3.	33

Galv-Krom® finish.