

PROJECT: TYPE:

LOCATION: CAT:



Dark Bronze



White

Description

3-in-1 modular dimmable LED undercabinet fixture with switchable color temperatures, a low profile housing, and glare-free acrylic lens.

Features

- Micro switch on housing can be set to 2400K, 3000K, or 4000K CCT (correlated color temperature)
- Powder coated aluminum housing
- Full length diffuse acrylic lens
- Multiple connection points hold PC board firmly against heat sink, optimizing heat dissipation and extending LED life
- Modular design with hardwire junction boxes, power cords, and linking cables (sold separately)
- Hardwire, modular, or plug-in power options

Mounting

Captive screws and quick stab wire connectors plus quick access door for hardwire installations

Applications

Under-cabinets, Task Lighting

Technical Information



Length	8"		16"	24"	32"	
Finish	DB	WH	DB	DB	DB	WH
Voltage	120V AC, 60Hz					
CCT	2400K-3000K-4000K					
CRI	80+ (2400K) / 90+ (3000K / 4000K)					
Wattage	6.4W		12.8W	14W	16.5W	
Lumens	340Lm	420Lm	690Lm	810Lm	910Lm	1100Lm
Max Run	150 Watts					
Beam Angle	106°					
Dimming	5-100% with most standard 2-wire and CL dimmers					
Rating	Energy Star, cETLus Listed, dry locations					
Rated Life	35,000 Hours					

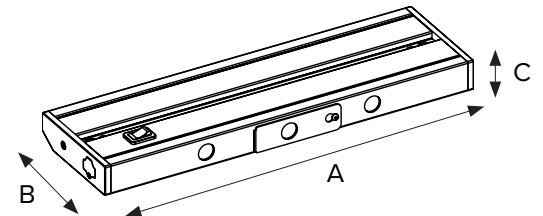

Part Number	A	B	C
3LC-8	8"	3-5/8"	15/16"
3LC-16	16"	3-5/8"	15/16"
3LC-24	24"	3-5/8"	15/16"
3LC-32	32"	3-5/8"	15/16"

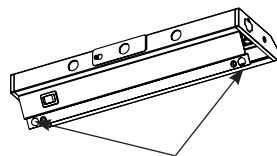

Easy access to wiring compartment

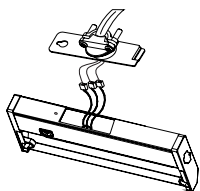

Convenient rear access door

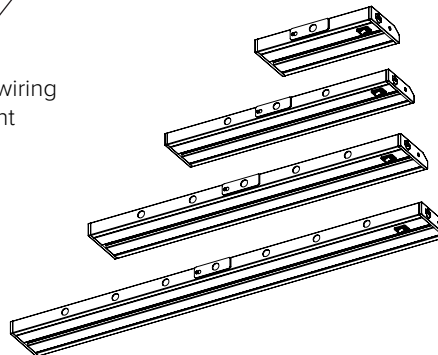

1/2" knockouts located on back end and underside of fixture, spaced every 4"

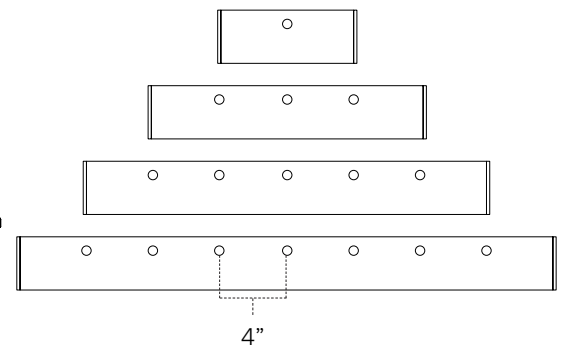

Ordering Information

3LC 24-30-40 Undercabinet

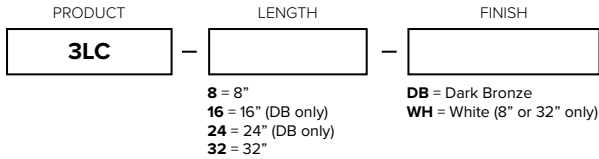

3LC fixtures include:

- (1) 3/8" Clamp connector
- (1) Inline/direct connector
- (2) Captive mounting screws
- (2) Mounting hole covers



Example Part # **3LC-32-DB**



Recommended Power Supplies

Part Number	Description	Finish	Application	Primary & Secondary	Total Wattage	Listing	Dimensions
ALC-BOX-DB	Hardwire box with male/female Molex connections, end power connection ports, (6) 3/8" knockouts, and On/Off rocker switch	Dark Bronze	Dry location	120V AC	150 x 2	cETLus	7-3/8"L x 2-1/8"W x 1"H
ALC-BOX-WH		White					
ALC-PC6-BK	6ft power cord with 3-prong grounded plug and Molex connector	Black	Dry location	120V AC	150	cETLus	6ft length
ALC-PC6-WH		White					

Accessories

Image	Part Number	Length	Finish	Description
	ALC-EX6-BK	6"	Black	Linking cable; 18AWG wire with male/female molex connectors; cETLus Listed
	ALC-EX12-BK	12"		
	ALC-EX6-WH	6"	White	Linking cable; 18AWG wire with male/female molex connectors; cETLus Listed
	ALC-EX12-WH	12"		
	ALC-CON-BK	N/A	Black	Replacement in-line connector for end-to-end connections; cETLus Listed
	ALC-CON-WH		White	

Compatible Dimmers

Brand	Model #	Type	Dimming Range	Notes
Lutron® Diva	DVELV-300P	Electronic Low Voltage (ELV)	5-100%	

The 3LC-Series undercabinet light is not compatible with the Leviton® Trimatron 6683.

Dimmer performance may vary in field application due to unknown external factors. Dimmers not included on the chart above are not necessarily incompatible; they have yet to be fully evaluated. Please reference dimmer manufacturer's instructions for more detailed information regarding performance and compatibility.

Photometrics

LED 3-Complete

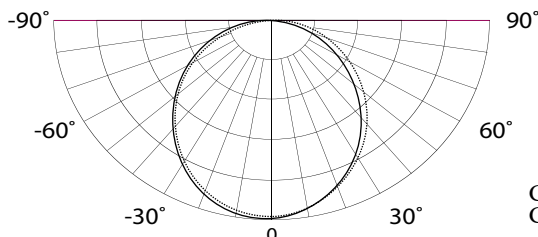

Model #	Amperage	Wattage
3LC2-8-xx	0.06	6.5
3LC2-16-xx	0.10	11
3LC2-24-xx	0.13	14.7
3LC2-32-xx	0.067	16.8

PROJECT: TYPE:

LOCATION: CAT:



Dark Bronze



White

Description

3-in-1 modular dimmable LED undercabinet fixture with switchable color temperatures, a low profile housing, and glare-free acrylic lens.

Features

- Micro switch on housing can be set to 2400K, 3000K, or 4000K CCT (correlated color temperature)
- Powder coated aluminum housing
- Full length diffuse acrylic lens
- Multiple connection points hold PC board firmly against heat sink, optimizing heat dissipation and extending LED life
- Modular design with hardwire junction boxes, power cords, and linking cables (sold separately)
- Hardwire, modular, or plug-in power options

Mounting

Captive screws and quick stab wire connectors plus quick access door for hardwire installations

Applications

Under-cabinets, Task Lighting

Technical Information



Length	8"		16"	24"	32"	
Finish	DB	WH	DB	DB	DB	WH
Voltage	120V AC, 60Hz					
CCT	2400K-3000K-4000K					
CRI	80+ (2400K) / 90+ (3000K / 4000K)					
Wattage	6.4W		12.8W	14W	16.5W	
Lumens	340Lm	420Lm	690Lm	810Lm	910Lm	1100Lm
Max Run	150 Watts					
Beam Angle	106°					
Dimming	5-100% with most standard 2-wire and CL dimmers					
Rating	Energy Star, cETLus Listed, dry locations					
Rated Life	35,000 Hours					

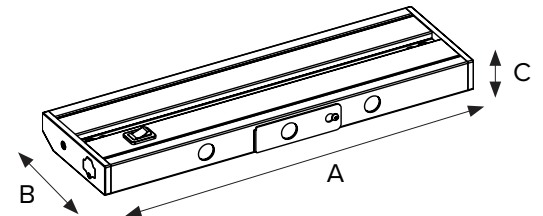

Part Number	A	B	C
3LC-8	8"	3-5/8"	15/16"
3LC-16	16"	3-5/8"	15/16"
3LC-24	24"	3-5/8"	15/16"
3LC-32	32"	3-5/8"	15/16"

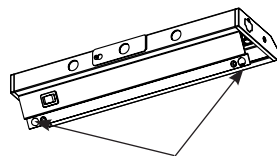

Easy access to wiring compartment

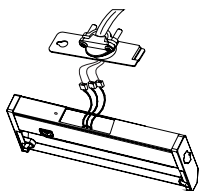

Convenient rear access door

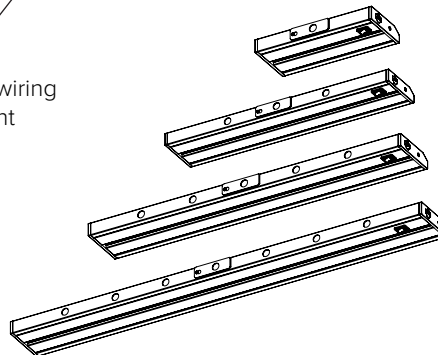

1/2" knockouts located on back end and underside of fixture, spaced every 4"

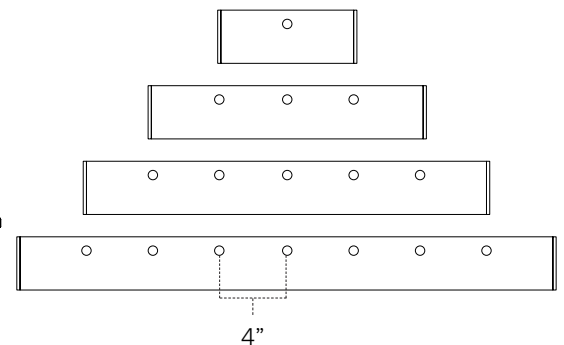

Ordering Information

3LC 24-30-40 Undercabinet

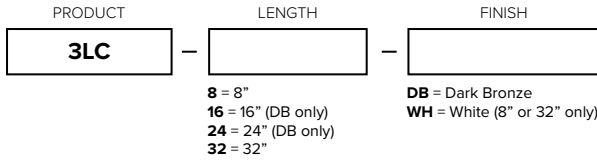

3LC fixtures include:

- (1) 3/8" Clamp connector
- (1) Inline/direct connector
- (2) Captive mounting screws
- (2) Mounting hole covers



Example Part # **3LC-32-DB**



Recommended Power Supplies

Part Number	Description	Finish	Application	Primary & Secondary	Total Wattage	Listing	Dimensions
ALC-BOX-DB	Hardwire box with male/female Molex connections, end power connection ports, (6) 3/8" knockouts, and On/Off rocker switch	Dark Bronze	Dry location	120V AC	150 x 2	cETLus	7-3/8"L x 2-1/8"W x 1"H
ALC-BOX-WH		White					
ALC-PC6-BK	6ft power cord with 3-prong grounded plug and Molex connector	Black	Dry location	120V AC	150	cETLus	6ft length
ALC-PC6-WH		White					

Accessories

Image	Part Number	Length	Finish	Description
	ALC-EX6-BK	6"	Black	Linking cable; 18AWG wire with male/female molex connectors; cETLus Listed
	ALC-EX12-BK	12"		
	ALC-EX6-WH	6"	White	Linking cable; 18AWG wire with male/female molex connectors; cETLus Listed
	ALC-EX12-WH	12"		
	ALC-CON-BK	N/A	Black	Replacement in-line connector for end-to-end connections; cETLus Listed
	ALC-CON-WH		White	

Compatible Dimmers

Brand	Model #	Type	Dimming Range	Notes
Lutron® Diva	DVELV-300P	Electronic Low Voltage (ELV)	5-100%	

The 3LC-Series undercabinet light is not compatible with the Leviton® Trimatron 6683.

Dimmer performance may vary in field application due to unknown external factors. Dimmers not included on the chart above are not necessarily incompatible; they have yet to be fully evaluated. Please reference dimmer manufacturer's instructions for more detailed information regarding performance and compatibility.

Photometrics

LED 3-Complete

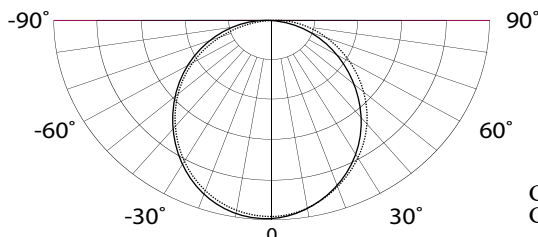

Model #	Amperage	Wattage
3LC2-8-xx	0.06	6.5
3LC2-16-xx	0.10	11
3LC2-24-xx	0.13	14.7
3LC2-32-xx	0.067	16.8