

Pow-R-Stock^{Plus} quick selector reference guide

Frequently used distribution
and control products available
from distributor stock



EATON

Powering Business Worldwide

Table of contents



Pow-R-Stock panelboards

Questions to ask	5
Catalog numbering	6
Interiors, EZ Boxes and EZ Trims.....	8
Branch circuit breakers	10
Universal main circuit breaker kits— top or bottom mounting	11
Lug kits and accessories	13



Safety switches/ disconnects

Questions to ask	14
Catalog numbering	15
General-duty safety switches	16
Heavy-duty safety switches	17
Safety switch kits	18



Transformers

Questions to ask	19
Catalog numbering	20
General-purpose transformers.....	22
Sizing tables	24



Enclosed control

Questions to ask	25
Catalog numbering	26
NEMA non-combination, non-reversing starters, Type 1	26
NEMA combination, non-reversing starters, non-fusible disconnect, Type 1	26
NEMA accessories.....	27
Lighting contactors.....	28



Pushbutton stations and pushbuttons

Questions to ask	29
30 mm pushbutton stations	30
22 mm pushbutton stations	30
Individually packaged 30 mm pushbuttons and operators.....	31



Manual starters

- Questions to ask 32
- Manual motor switches without overload 33
- Single-phase manual starter with overload protection 33
- Single- and three-phase manual starters with
overload protection 33

Questions to ask

Step 1

1

Select an interior

Q What is your voltage?

A — 120/240 V single-phase, three-wire
— 208Y/120 V three-phase, four-wire
— 480Y/277 V three-phase, four-wire

Q What is your busbar rating?

A — 100 A (aluminum or copper)
— 225 A (aluminum or copper)
— 400 A (aluminum or copper)
— 600 A (aluminum or copper)

Q What is the number of branch circuits/poles?

A — 18
— 30
— 42

Step 2

2

Enclosure type

Q What enclosure is required?

A — NEMA® 1 indoor
— NEMA 3R outdoor

Step 3

3

Trim type

Q For NEMA 1 indoor panels, will the panel be mounted recessed in the wall or mounted directly to the wall?

A — Flush
— Surface

Step 4

4

Q What is the cable entry locations for the incoming feeder?

A — Top
— Bottom

Step 5

5

Main device

Q Main lugs only (MLO) or main circuit breaker?

A — MLO
— MCB (choose amperage and top or bottom)

Pow-R-Stock panelboards (unassembled)

Catalog numbering system— Pow-R-Stock panelboard interiors

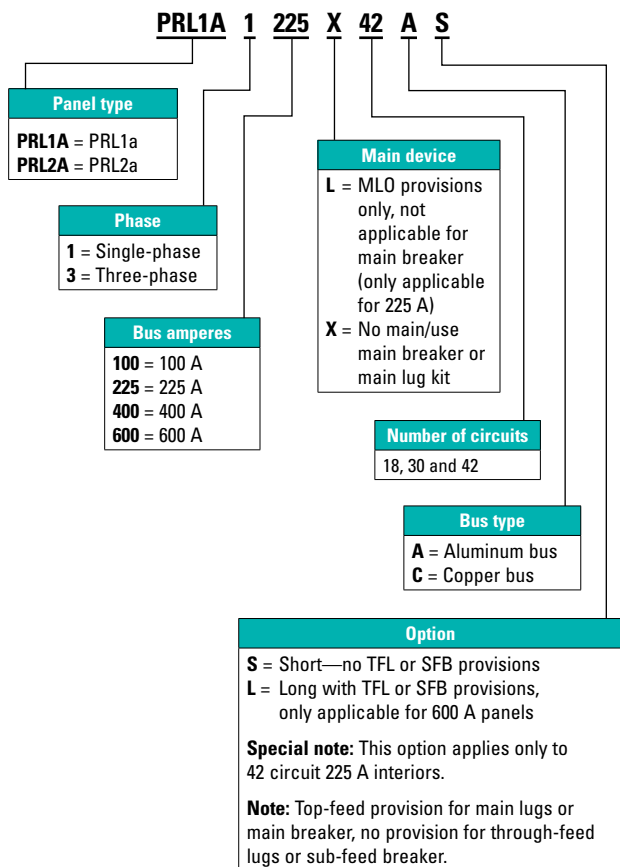

Catalog numbering system— EZ Panel factory-assembled stock panelboards

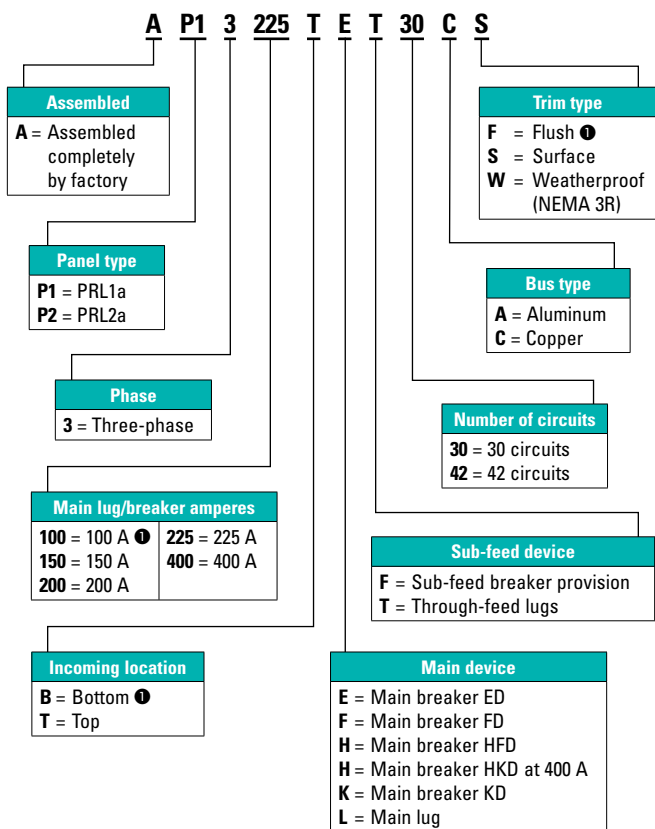

❶ These items are not part of the initial launch. Please consult VISTA or your Eaton sales engineer for product availability.

Notes: Not all combinations may be valid. Please verify availability of catalog number created. Refer to PA014007EN for more information on the EZ Panel.

Pow-R-Stock panelboards—EZ™ Boxes and EZ Trims

Ampere rating	Max. number of poles	Capability				Catalog numbers	
		Main lugs	Main breaker	Through-feed lugs	Sub-feed breaker (225 A max.)	Interiors (less main device)	Aluminum bus
Single-phase, three-wire 120/240 Vac							
100	18	■	■	■	N/A		PRL1A1100X18A
100	30	■	■	■	100		PRL1A1100X30A
100	42	■	■	■	N/A		PRL1A1100X42A
225	30	■	■	■	100, 125, 150, 175, 200, 225		PRL1A1225X30A
225	42	■	■	N/A	N/A		PRL1A1225X42AS ❶
225	42	■	■	■	100, 125, 150, 175, 200, 225		PRL1A1225X42A
400	42	■	■	N/A	N/A		PRL1A1400X42AS ❶
400	42	■	■	■	100, 125, 150, 175, 200, 225		PRL1A1400X42A
600	42	■	■	■	N/A		
600	42	■	■	■	100, 125, 150, 175, 200, 225, 250, 300, 350, 400		
Three-phase, four-wire 208Y/120 Vac							
100	18	■	■	■	N/A		PRL1A3100X18A
100	30	■	■	■	100		PRL1A3100X30A
100	42	■	■	■	N/A		PRL1A3100X42A
225	30	■	■	■	100, 125, 150, 175, 200, 225		PRL1A3225X30A
225	42	■	N/A	N/A	N/A		PRL1A3225L42AS ❶
225	42	■	■	N/A	N/A		PRL1A3225X42AS ❶
225	42	■	■	■	100, 125, 150, 175, 200, 225		PRL1A3225X42A
400	42	■	■	N/A	N/A		PRL1A3400X42AS ❶
400	42	■	■	■	100, 125, 150, 175, 200, 225		PRL1A3400X42A
600	42	■	■	■	N/A		
600	42	■	■	■	100, 125, 150, 175, 200, 225, 250, 300, 350, 400		
Three-phase, four-wire 480Y/277 Vac							
100	18	■	■	■	N/A		PRL2A3100X18A
100	30	■	■	■	100		PRL2A3100X30A
100	42	■	■	■	N/A		PRL2A3100X42A
225	30	■	■	■	100, 125, 150, 175, 200, 225		PRL2A3225X30A
225	42	■	N/A	N/A	N/A		PRL2A3225L42AS ❶
225	42	■	■	N/A	N/A		PRL2A3225X42AS ❶
225	42	■	■	■	100, 125, 150, 175, 200, 225		PRL2A3225X42A
400	42	■	■	N/A	N/A		PRL2A3400X42AS ❶
400	42	■	■	■	100, 125, 150, 175, 200, 225		PRL2A3400X42A
600	42	■	■	■	N/A		
600	42	■	■	■	100, 125, 150, 175, 200, 225, 250, 300, 350, 400		

❶ S = Short—no TFL or SFB provisions.

Copper bus	Boxes	Trims (NEMA 1)		NEMA 3R enclosures
	NEMA 1	Surface	Flush	
PRL1A1100X18C	EZB2036R	EZT2036S	EZT2036F	GWPBQ2036PR
PRL1A1100X30C	EZB2048R	EZT2048S	EZT2048F	GWPBQ2048PR
PRL1A1100X42C	EZB2048R	EZT2048S	EZT2048F	GWPBQ2048PR
PRL1A1225X30C	EZB2048R	EZT2048S	EZT2048F	GWPBQ2048PR
PRL1A1225X42CS ①	EZB2048R	EZT2048S	EZT2048F	GWPBQ2048PR
PRL1A1225X42C	EZB2060R	EZT2060S	EZT2060F	GWPBQ2060PR
PRL1A1400X42CS ①	EZB2060R	EZT2060S	EZT2060F	GWPBQ2060PR
PRL1A1400X42C	EZB2072R	EZT2072S	EZT2072F	GWPBQ2072PR
PRL1A1600X42C	EZB2072R	EZT2072S	EZT2072F	GWPBQ2072PR
PRL1A1600X42CL	EZB2090R	EZT2090S	EZT2090F	GWPBQ2090PR
PRL1A3100X18C	EZB2036R	EZT2036S	EZT2036F	GWPBQ2036PR
PRL1A3100X30C	EZB2048R	EZT2048S	EZT2048F	GWPBQ2048PR
PRL1A3100X42C	EZB2048R	EZT2048S	EZT2048F	GWPBQ2048PR
PRL1A3225X30C	EZB2048R	EZT2048S	EZT2048F	GWPBQ2048PR
PRL1A3225L42CS ①	EZB2042R	EZT2042S	EZT2042F	GWPBQ2042PR
PRL1A3225X42CS ①	EZB2048R	EZT2048S	EZT2048F	GWPBQ2048PR
PRL1A3225X42C	EZB2060R	EZT2060S	EZT2060F	GWPBQ2060PR
PRL1A3400X42CS ①	EZB2060R	EZT2060S	EZT2060F	GWPBQ2060PR
PRL1A3400X42C	EZB2072R	EZT2072S	EZT2072F	GWPBQ2072PR
PRL1A3600X42C	EZB2072R	EZT2072S	EZT2072F	GWPBQ2072PR
PRL1A3600X42CL	EZB2090R	EZT2090S	EZT2090F	GWPBQ2090PR
PRL2A3100X18C	EZB2036R	EZT2036S	EZT2036F	GWPBQ2036PR
PRL2A3100X30C	EZB2048R	EZT2048S	EZT2048F	GWPBQ2048PR
PRL2A3100X42C	EZB2048R	EZT2048S	EZT2048F	GWPBQ2048PR
PRL2A3225X30C	EZB2048R	EZT2048S	EZT2048F	GWPBQ2048PR
PRL2A3225L42CS ①	EZB2042R	EZT2042S	EZT2042F	GWPBQ2042PR
PRL2A3225X42CS ①	EZB2048R	EZT2048S	EZT2048F	GWPBQ2048PR
PRL2A3225X42C	EZB2060R	EZT2060S	EZT2060F	GWPBQ2060PR
PRL2A3400X42CS ①	EZB2060R	EZT2060S	EZT2060F	GWPBQ2060PR
PRL2A3400X42C	EZB2072R	EZT2072S	EZT2072F	GWPBQ2072PR
PRL2A3600X42C	EZB2072R	EZT2072S	EZT2072F	GWPBQ2072PR
PRL2A3600X42CL	EZB2090R	EZT2090S	EZT2090F	GWPBQ2090PR

Note: The colors shown in the tables correspond to the color coding on the trim, interior and box product packaging labels. Be sure that all three parts match when delivering to your customer.

Note: Distributors can purchase boxes in quantities via the Distributor toolbox.

Branch circuit breakers

Summary of branch breakers available

Breaker	No. of poles	Ampere rating	Voltage	kAIC rating	Example	Panel type
BAB ①②	1	15–70	120	10	BAB1020	PRL1a
	2	15–100	120/240	10	BAB2020	PRL1a
	2	15–100	240	10	BAB2040H	PRL1a
	3	15–100	240	10	BAB3030H	PRL1a
QBAF	1	15–20	120	10	QBAF1020	PRL1a
QBHAF	1	15–20	120	22	QBHAF1020	PRL1a
QBCAF	1	15–20	120	10	QBCAF1020	PRL1a
QBHCAF	1	15–20	120	22	QBHCAF1020	PRL1a
QBGFT	1	15–40	120	10	QBGFT1020	PRL1a
	2	15–50	120/240	10	QBGFT2040	PRL1a
QBHGFT	1	15–30	120	22	QBHGFT1020	PRL1a
	2	15–30	120/240	22	QBHGFT2020	PRL1a
QBGFEP	1	15–40	120	10	QBGFEP1020	PRL1a
	2	15–50	120/240	10	QBGFEP2020	PRL1a
QBHGFEF	1	15–30	120	22	QBHGFEF1020	PRL1a
	2	15–30	120/240	22	QBHGFEF2020	PRL1a
QBHW ①	1	15–70	120	22	QBHW1020	PRL1a
	2	15–100	120/240	22	QBHW2020	PRL1a
	2	15–100	240	22	QBHW2040H	PRL1a
	3	15–100	240	22	QBHW3030H	PRL1a
GHQ ①	1	15–20	277	14	GHQ1020	PRL2a
GHB ①②	1	15–100	277	14	GHB1020	PRL2a
	2	15–100	480Y/277	14	GHB2040	PRL2a
	3	15–100	480Y/277	14	GHB3060	PRL2a

① BAB, QBHW, GHQ and GHB breakers installed in PRL1a and PRL2a are available with shunt trip, i.e., BAB1020S.

② BAB-H and GHB 50–100 A available as chassis-mounted main device.

Universal main circuit breaker kits— top or bottom mounting

Kits—main circuit breaker (includes circuit breaker and terminals)

Max. volt.	Ampere rating	Service	Breaker frame	Mounting location	Wire range Al/Cu (in kcmil)	Catalog number
240 Vac	100	Single- or three-phase	ED	Universal	(1) #14–1/0	BKED100
	125	Single- or three-phase	ED	Universal	(1) #4–4/0	BKED125
	150	Single- or three-phase	ED	Universal	(1) #4–4/0	BKED150
	175	Single- or three-phase	ED	Universal	(1) #4–4/0 ①	BKED175
	200	Single- or three-phase	ED	Universal	(1) #4–4/0 ①	BKED200
	225	Single- or three-phase	ED	Universal	(1) #4–4/0 ①	BKED225
480 Vac	100	Single- or three-phase	FD	Universal	(1) #14–1/0	BKFD100
	110	Single- or three-phase	FD	Universal	(1) #4–4/0	BKFD110
	125	Single- or three-phase	FD	Universal	(1) #4–4/0	BKFD125
	150	Single- or three-phase	FD	Universal	(1) #4–4/0	BKFD150
	175	Single- or three-phase	FD	Universal	(1) #4–4/0 ①	BKFD175
	200	Single- or three-phase	FD	Universal	(1) #4–4/0 ①	BKFD200
	225	Single- or three-phase	FD	Universal	(1) #4–4/0 ①	BKFD225
480 Vac	100	Single- or three-phase	HFD	Universal	(1) #14–1/0	BKHFD100
	110	Single- or three-phase	HFD	Universal	(2) #4–4/0	BKHFD110
	125	Single- or three-phase	HFD	Universal	(2) #4–4/0	BKHFD125
	150	Single- or three-phase	HFD	Universal	(2) #4–4/0	BKHFD150
	175	Single- or three-phase	HFD	Universal	(2) #4–4/0	BKHFD175
	200	Single- or three-phase	HFD	Universal	(2) #4–4/0	BKHFD200
	225	Single- or three-phase	HFD	Universal	(2) #4–4/0	BKHFD225
480 Vac	250	Single- or three-phase	KD	Universal	(1) 250–500	BKKD250
	300	Single- or three-phase	KD	Universal	(1) 250–500	BKKD300
	350	Single- or three-phase	KD	Universal	(1) 250–500	BKKD350
	400	Single- or three-phase	KD	Universal	(2) 3/0–250 or (1) 3/0–500	BKKD400

① Order optional lug kit catalog no. 3TA225FDK for 175–225 A ED- and FD-Frame three-pole circuit breakers to provide terminations for (1) #6–300 kcmil.

Note: KD kits are to be used on 400 A and 600 A panels only.

Universal main circuit breaker kits— top or bottom mounting

Kits—main circuit breaker (includes circuit breaker and terminals)

Max. volt.	Ampere rating	Service	Breaker frame	Mounting location	Wire range Al/Cu (in kcmil)	Catalog number
480 Vac	250	Single- or three-phase	HKD	Universal	(1) 250–500	BKHKD250
	300	Single- or three-phase	HKD	Universal	(1) 250–500	BKHKD300
	350	Single- or three-phase	HKD	Universal	(1) 250–500	BKHKD350
	400	Single- or three-phase	HKD	Universal	(1) 250–500	BKHKD400
480 Vac	400	Single- or three-phase	LG	Universal	(1) #2–500	BKLGE400
	500	Single- or three-phase	LG	Universal	(2) #2–500	BKLGE500
	600	Single- or three-phase	LG	Universal	(2) #2–500	BKLGE600

Lug kits and accessories

Standard main/sub-feed breaker lug capacities

Ampere rating	Lug wire range Al/Cu
100	(1) #14–1/0
125–225	(1) #4–4/0
250–350	(1) 250–500 kcmil
400	(2) 3/0–250 kcmil or (1) 3/0–500 kcmil

Main/through-feed lug kits

Ampere rating	Wire range Al/Cu	Catalog number
100	(1) #14–1/0	LUGKIT100
225	(1) #6–300 kcmil	LUGKIT225
400	(2) #2–500 kcmil	LUGKIT400
600	(2) #2–500 kcmil	LUGKIT600

Kits

Description	Catalog number		
	100 A	225 A	400/600 A
Service entrance kit—MLO	SEK1/2 ①	SEK1/2 ①	SEK4/6 ①
Service entrance kit—MCB	SEKB ②④ SEKG ③④	SEKF ④⑤	SEKKL ④⑥
200% neutral kit	2NK100	2NK225	1NK400
Sub-feed breaker adapter (used to mount 225 A sub-feed breaker in 400 A panels)	—	—	225ASFBKIT
Sub-feed breaker adapter (used to mount 225 A sub-feed breaker in 600 A panels)	—	—	225BSFBKIT
Sub-feed breaker adapter (used to mount 400 A sub-feed breaker in 600 A panels)	—	—	400ASFBKIT

① Applicable for use with MLO, SE panels only.

② Only applicable for SE PRL1a with chassis-mounted BAB, QBH main breaker.

③ Only applicable for SE PRL2a with chassis-mounted GHB main breaker.

④ Main breaker panels only—includes barrier kit and bonding jumper.

⑤ To be used with F-frame main breaker.

⑥ To be used with K- and L-frame main breaker.

Accessories

Description	Catalog number
Isolated ground bar kit	ISOGROUND
Copper ground bar kit	CUGROUND
1P filler plate ①	5155C62H01
Series rating kit ②	SRK

① Each PRS panel comes with 50% filler plates, e.g., 18 circuit interior contains 9 filler plates.

② Series rating kit includes series rating book and adhesive sleeve and series rating sticker. If panelboard is being series rated higher than the base rating, an SRK is required.

Questions to ask

Step 1

1

Q Which type of switch do you need?

- A
- Heavy-duty (DH)
 - General-duty (DG)
 - Double-throw (DT)

Step 2

2

Q What current (ampere) rating do you need?

- A
- 30, 60, 100, 200, 400, 600, 800, 1200

Step 3

3

Q Should it be fused, non-fused or fusible with neutral?

- A
- F = Fusible without neutral
 - U = Non-fusible
 - N = Fusible with neutral

Step 4

4

Q How many poles?

- A
- 1, 2, 3, 4, 6

Step 5

5

Q Choose the maximum circuit voltage.

- A
- 240 Vac
 - 600 Vac

Step 6

6

Q What type of enclosure do you need?

- A
- NEMA 1
 - NEMA 3R
 - NEMA 12
 - NEMA 4 painted steel
 - NEMA 4X stainless steel
 - NEMA 4X non-metallic

Safety switches/ disconnects

Catalog numbering system—safety switches

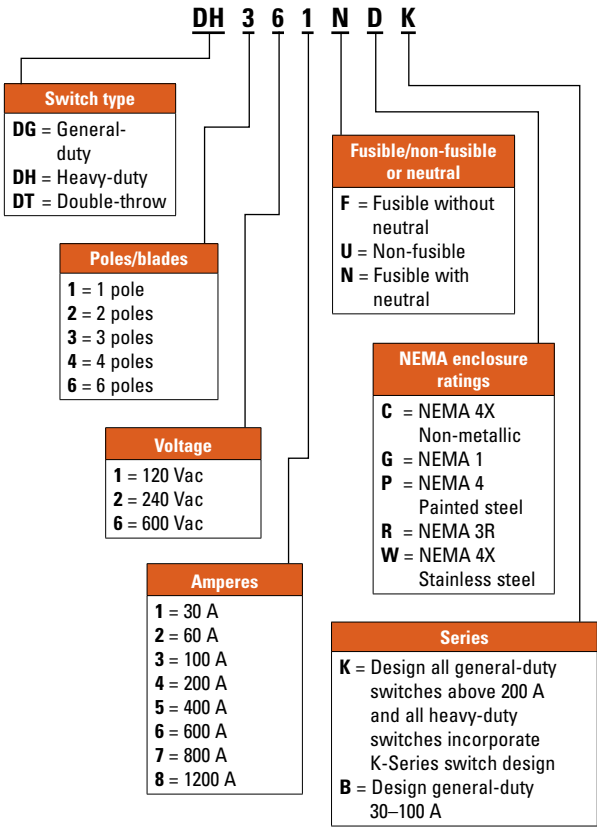

General-duty safety switches (disconnects)

Two-pole—240 Vac (suitable for service entrance use with a neutral or ground kit)

Current rating (amps)	Type	Enclosure type	Max. hp ratings		Catalog number
			Single-phase		
			120 Vac	240 Vac	
30	Fusible with neutral	NEMA 1		1.5–3	DG221NGB
30	Non-fusible	NEMA 1	2	3	DG221UGB
30	Fusible with neutral	NEMA 3R		1.5–3	DG221NRB
30	Non-fusible	NEMA 3R	2	3	DG221URB
60	Fusible with neutral	NEMA 1		3–10	DG222NGB
60	Non-fusible	NEMA 1	3	10	DG222UGB
60	Fusible with neutral	NEMA 3R		3–10	DG222NRB
60	Non-fusible	NEMA 3R	1	10	DG222URB
100	Fusible with neutral	NEMA 1		7.5–15	DG223NGB
100	Non-fusible	NEMA 1		15	DG223UGB
100	Fusible with neutral	NEMA 3R		7.5–15	DG223NRB
100	Non-fusible	NEMA 3R		15	DG223URB

Three-pole—240 Vac (suitable for service entrance use with a neutral or ground lug kit)

Current rating (amps)	Type	Enclosure type	Max. hp ratings ①		Catalog number
			Single-phase	Three-phase	
			240 Vac	240 Vac	
30	Fusible with neutral	NEMA 1	1.5–3	3–7.5	DG321NGB
30	Non-fusible	NEMA 1	3	7.5	DG321UGB
30	Fusible with neutral	NEMA 3R	1.5–3	3–7.5	DG321NRB
30	Non-fusible	NEMA 3R	3	7.5	DG321URB
60	Fusible with neutral	NEMA 1	3–10	7.5–15	DG322NGB
60	Non-fusible	NEMA 1	10	15	DG322UGB
60	Fusible with neutral	NEMA 3R	3–10	7.5–15	DG322NRB
60	Non-fusible	NEMA 3R	10	15	DG322URB
100	Fusible with neutral	NEMA 1	7.5–15	15–30	DG323NGB
100	Non-fusible	NEMA 1	15	30	DG323UGB
100	Fusible with neutral	NEMA 3R	7.5–15	15–30	DG323NRB
100	Non-fusible	NEMA 3R	15	30	DG323URB

① Maximum hp ratings for fusible units apply only when dual element time-delay fuses are used.

Neutral and ground lug kits

Description	Catalog number
Neutral kit for 30 A switches	DG030NB
Neutral kit for 60–100 A switches	DG100NB
Ground lug kit for 30–100 A switches	DG030GB

Class R fuse adapter kits

Ampere rating	Type	Voltage	Catalog number
30	General-duty	240	DG30RB
60	General-duty	240	DS16FK
100	General-duty	240	DG100RB

Heavy-duty safety switches (disconnects)

Three-pole—480–600 Vac (suitable for service entrance use with a neutral or ground lug kit below)

Current rating (amps)	Type	Enclosure type	Max. hp ratings				Catalog number
			Single-phase		Three-phase		
			480 V	600 V	480 V	600 V	
30	Fusible	NEMA 1	7.5	15	10	20	DH361FGK ❶
30	Non-fusible	NEMA 1	7.5	15	10	20	DH361UGK
30	Fusible	NEMA 3R	7.5	15	10	20	DH361FRK ❶
30	Non-fusible	NEMA 3R	7.5	15	10	20	DH361URK
30	Fusible	NEMA 4X	7.5	10	15	20	DH361FWK ❶
30	Non-fusible	NEMA 4X	7.5	10	20	30	DH361UWK
60	Fusible	NEMA 1	20	30	25	50	DH362FGK
60	Non-fusible	NEMA 1	20	30	25	50	DH362UGK
60	Fusible	NEMA 3R	20	30	25	50	DH362FRK
60	Non-fusible	NEMA 3R	20	30	25	50	DH362URK
60	Fusible	NEMA 4X	20	25	30	50	DH362FWK
60	Non-fusible	NEMA 4X	20	25	50	60	DH362UWK
100	Fusible	NEMA 1	30	60	40	75	DH363FGK
100	Non-fusible	NEMA 1	30	60	40	75	DH363UGK
100	Fusible	NEMA 3R	30	60	40	75	DH363FRK
100	Non-fusible	NEMA 3R	30	60	40	75	DH363URK
100	Fusible	NEMA 4X	30	40	60	75	DH363FWK
100	Non-fusible	NEMA 4X	40	50	75	100	DH363UWK
200	Fusible	NEMA 1	50	125	50	150	DH364FGK
200	Non-fusible	NEMA 1	50	125	50	150	DH364UGK
200	Fusible	NEMA 3R	50	125	50	150	DH364FRK
200	Non-fusible	NEMA 3R	50	125	50	150	DH364URK
200	Fusible	NEMA 4X	50	50	125	150	DH364FWK
200	Non-fusible	NEMA 4X	50	50	125	125	DH364UWK

❶ For 30 A switches requiring Class J fusing, switch must be ordered with the Class J clips from the factory by adding a suffix "J" on the end.

Safety switch kits

Neutral and ground lug kits ①

Description	Catalog number
Neutral kit for 30–60 A switches	DH030NK
Neutral kit for 100 A switches	DH100NK
Neutral kit for 200 A switches	DG200NK
Ground lug kit for 30–100 A switches	DS100GK
Ground lug kit for 200 A switches	DS200GK

- ① A factory-installed ground lug is supplied on all NEMA 4, 4X and 12 safety switches, as well as all 400 A and higher NEMA 1 and 3R safety switches. A factory-installed ground lug is also supplied on all heavy-duty NEMA 1 and 3R 30–200 A switches that do not have a factory installed neutral.

Class R fuse adapter kits

Ampere rating	Type	Voltage	Catalog number
30	Heavy-duty	600	DS16FK
60	Heavy-duty	600	DS26FK
100	Heavy-duty	600	DS36FK
200	Heavy-duty	600	DS346FK

Class J fuse adapter kit ①

Ampere rating	Type	Voltage	Catalog number
60	Heavy-duty	600	DS26JK

- ① 30 A switches must be ordered from the factory with Class J fuse provisions by adding suffix “J” at the end of the switch catalog number. 100 A and 200 A switches can be field modified by moving the load side fuse base.

Questions to ask

Step 1

1

Q How many phases?

A — Single-phase
— Three-phase

Step 2

2

Q What type of enclosure is required?

A — Ventilated
— Encapsulated

Step 3

3

Q What is the primary voltage? (input voltage)

A — Single-phase is 240 V x 480 V
— Three-phase is 480 V delta (three-phase, three-wire)

Step 4

4

Q What is the secondary voltage? (output voltage)

A — Single-phase
— 120/240

— Three-phase
— 208Y/120 (three-phase, four-wire) or 240 V delta

Step 5

5

Q What kVA transformer is required?

A — If single-phase encapsulated, kVAs are:
0.05, 0.075, 0.1, 0.15, 0.25, 0.5, 0.75, 1,
1.5, 2, 3, 5, 7.5, 10, 15, 25, 37.5
— If single-phase ventilated, kVAs are:
15, 25, 37.5, 50, 75, 100, 167
— If three-phase encapsulated, kVAs are:
3, 6, 9, 15, 30, 45, 75
— If three-phase ventilated, kVAs are:
15, 30, 45, 75, 112.5, 150, 225, 300

Step 6

6

Q If a ventilated transformer was selected

A — Field kits: lug kits or weathershields
— Select from selection tables

Transformers

Catalog numbering system—DOE 2016 ventilated transformers

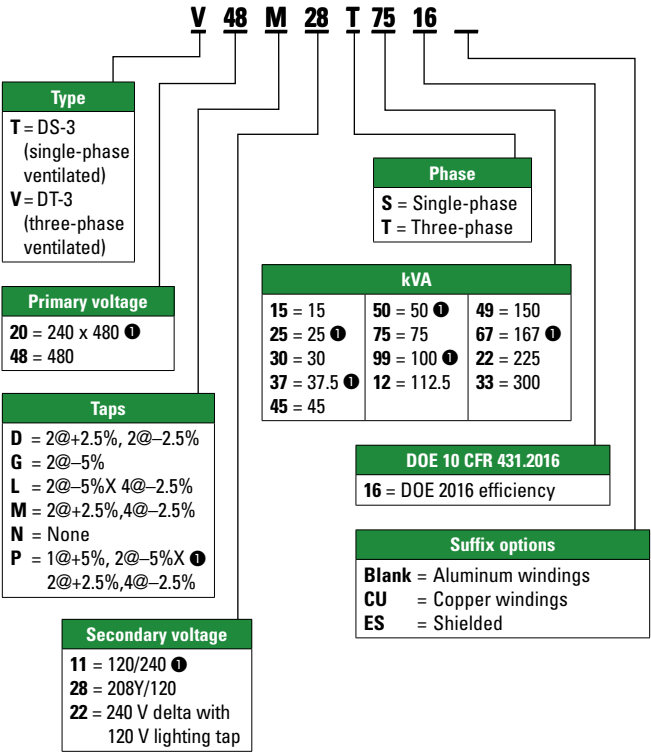

① Typically used with single-phase transformers.

Catalog numbering system—encapsulated transformers

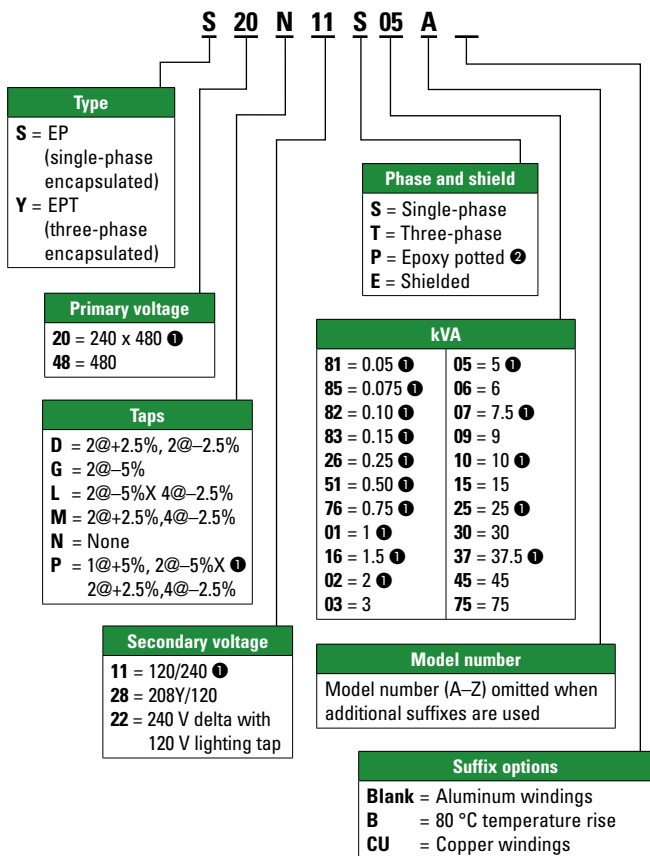

❶ Typically used with single-phase transformers.

❷ Single-phase 0.25–2 kVA encapsulated transformers only.

General-purpose transformers

Three-phase ventilated, 480 delta—208 Y/120, 150 °C rise, aluminum windings, DOE 2016

kVA	Frame number	Wiring diagram	Weathershield	Typical lug kit	Catalog number
15	939	280B	WS57	LKS1	V48M28T1516 ①
30	940	280B	WS58	LKS1	V48M28T3016 ①
45	940	280B	WS58	LKS1	V48M28T4516 ①
75	942	280B	WS59	LKS2	V48M28T7516 ②
112.5	943	280B	WS60	LKS2	V48M28T1216 ②
150	943	280B	WS60	LKS3	V48M28T4916 ②
225	944	280B	WS61	LKS3	V48M28T2216
300	945	280B	WS62	LKS3	V48M28T3316

① Suitable for use with wall-mounted bracket WMB05.

② Suitable for use with wall-mounted bracket WMB04.

Three-phase ventilated, 480 delta—240/120 lighting tap, 150 °C rise, aluminum windings, DOE 2016

kVA	Frame number	Wiring diagram	Weathershield	Typical lug kit	Catalog number
15	939	282B	WS57	LKS1	V48M22T1516 ①
30	940	282B	WS58	LKS1	V48M22T3016 ①
45	940	282B	WS58	LKS1	V48M22T4516 ①
75	942	282B	WS59	LKS2	V48M22T7516 ②
112.5	943	282B	WS60	LKS2	V48M22T1216 ②
150	943	282B	WS60	LKS3	V48M22T4916 ②
225	944	282B	WS61	LKS3	V48M22T2216
300	945	282B	WS62	LKS3	V48M22T3316

① Suitable for use with wall-mounted bracket WMB05.

② Suitable for use with wall-mounted bracket WMB04.

Three-phase encapsulated, 480 delta—208 Y/120, 115 °C rise

kVA	Frame number	Wiring diagram	Catalog number
3	201	70A	Y48G28T03N
6	200	70A	Y48G28T06N
9	103	70A	Y48G28T09N
15	95	72B	Y48D28T15N
30	243	84A	Y48M28T30N
45	244	84A	Y48M28T45N
75	245	84A	Y48M28T75N

Note: For frame drawings and wiring diagrams, refer to www.eaton.com/transformers.

General-purpose transformers

Single-phase ventilated, 240 x 480–120/240, 150 °C rise, aluminum windings, DOE 2016

kVA	Frame number	Wiring diagram	Weathershield	Typical lug kit	Catalog number
15	842	3XA	WS45	LKS1	T20P11S1516 ①
25	842	3XA	WS45	LKS1	T20P11S2516 ①
37.5	843	3XA	WS43	LKS1	T20P11S3716
50	843	3XA	WS43	LKS2	T20P11S5016
75	844	3XA	WS44	LKS2	T20P11S7516
100	844	3XA	WS44	LKS3	T20P11S9916
167	814	288A	WS13	LKS3	T48P11S6716 ②

① Suitable for use with wall-mounted bracket WMB01.

② 480 V primary only.

Single-phase encapsulated 240 x 480–120/240, 115 °C rise

kVA	Frame number	Wiring diagram	Catalog number
0.05	52	3A	S20N11S81N
0.075	53	3A	S20N11S85N
0.1	54	3A	S20N11S82N
0.15	55	3A	S20N11S83N
0.25	57P	3A	S20N11P26P
0.5	57P	3A	S20N11P51P
0.75	58P	3A	S20N11P76P
1	67P	3A	S20N11P01P
1.5	67P	3A	S20N11P16P
2	68P	3A	S20N11P02P
3	176	3A	S20N11S03N
5	177	3A	S20N11S05N
7.5	178	3A	S20N11S07N
10	179	3A	S20N11S10N
15	180	3A	S20N11S15N
25	182	23A	S20L11S25N
37.5	300A	248A	S20L11S37

Note: For frame drawings and wiring diagrams, refer to www.eaton.com/transformers.

General-purpose transformers sizing tables

Three-phase transformer full load current

kVA	Rated line-line voltage						
	208	240	480	600	2400	4160	4800
3	8.3	7.2	3.6	2.9	0.7	0.4	0.4
6	16.7	14.4	7.2	5.8	1.4	0.8	0.7
9	25.0	21.7	10.8	8.7	2.2	1.2	1.1
15	41.6	36.1	18.0	14.4	3.6	2.1	1.8
30	83.3	72.2	36.1	28.9	7.2	4.2	3.6
45	124.9	108.3	54.1	43.3	10.8	6.2	5.4
75	208.2	180.4	90.2	72.2	18.0	10.4	9.0
112.5	312.3	270.6	135.3	108.3	27.1	15.6	13.5
150	416.4	360.9	180.4	144.3	36.1	20.8	18.0
225	624.6	541.3	270.6	216.5	54.1	31.2	27.1
300	832.7	721.7	360.9	288.7	72.2	41.6	36.1
500	1387.9	1202.8	601.4	481.1	120.3	69.4	60.1
750	2081.9	1804.3	902.1	721.7	180.4	104.1	90.2
1000	2775.8	2405.7	1202.8	962.3	240.6	138.8	120.3

Note: Line current = (kVA x 1000) / (line voltage x 1.732).

Single-phase transformer full load current

kVA	Rated line-line voltage								
	120	208	240	277	480	600	2400	4160	4800
0.5	4.2	2.4	2.1	1.8	1.0	0.8	0.2	0.1	0.1
1	8.3	4.8	4.2	3.6	2.1	1.7	0.4	0.2	0.2
1.5	12.5	7.2	6.3	5.4	3.1	2.5	0.6	0.4	0.3
2	16.7	9.6	8.3	7.2	4.2	3.3	0.8	0.5	0.4
3	25.0	14.4	12.5	10.8	6.3	5.0	1.3	0.7	0.6
5	41.7	24.0	20.8	18.1	10.4	8.3	2.1	1.2	1.0
7.5	62.5	36.1	31.3	27.1	15.6	12.5	3.1	1.8	1.6
10	83.3	48.1	41.7	36.1	20.8	16.7	4.2	2.4	2.1
15	125.0	72.1	62.5	54.2	31.3	25.0	6.3	3.6	3.1
25	208.3	120.2	104.2	90.3	52.1	41.7	10.4	6.0	5.2
37.5	312.5	180.3	156.3	135.4	78.1	62.5	15.6	9.0	7.8
50	416.7	240.4	208.3	180.5	104.2	83.3	20.8	12.0	10.4
75	625.0	360.6	312.5	270.8	156.3	125.0	31.3	18.0	15.6
100	833.3	480.8	416.7	361.0	208.3	166.7	41.7	24.0	20.8
167	1391.7	802.9	695.8	602.9	347.9	278.3	69.6	40.1	34.8
250	2083.3	1201.9	1041.7	902.5	520.8	416.7	104.2	60.1	52.1
333	2775.0	1601.0	1387.5	1202.2	693.8	555.0	138.8	80.0	69.4

Note: Line current = (kVA x 1000) / line voltage.

Questions to ask

Step 1

1

Q What type of enclosure do you need?

- A**
- NEMA 1 (general-duty)
 - NEMA 3R (rain-tight)
 - NEMA 12 (dust-tight)
 - NEMA 4X (wash-down)

Step 2

2

Q What type of starter do you need?

- A**
- NEMA non-combination
 - NEMA combination, non-fusible or fusible
 - NEMA combination, breaker
 - Lighting contactor

Step 3

3

Q What is the horsepower and voltage of the motor?
(Note: this will determine the NEMA starter size)

- A**
- Horsepower: 1, 5, 10, 25 hp etc.
 - Motor voltage: 200, 230, 460, 575 V

Step 4

4

Q What is the control voltage for the coil?

- A**
- 120 Vac
 - 240 Vac
 - 480 Vac

Step 5

5

Q What size overload relay is needed?

- A**
- 1–5 FLA
 - 4–20 FLA
 - 9–45 FLA

Step 6

6

Q What additional accessories do you need?

- A**
- Cover control kits, such as HAND/OFF/AUTO selector switch or STOP/START pushbuttons
 - CPT kits
 - Fuse kits

Enclosed control

Catalog numbering system—non-combination and combination NEMA enclosed starters

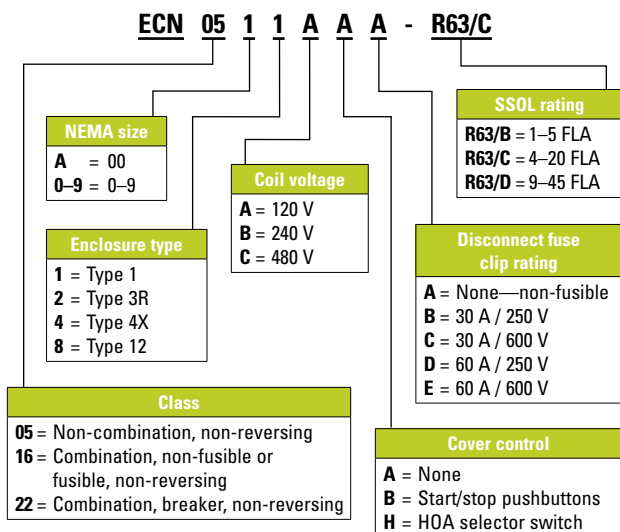

Starters

NEMA non-combination, non-reversing starters, Type 1

NEMA size	Motor voltage	Maximum hp rating	Magnet coil voltage	SSOL range	Catalog number
00	200, 230	1-1/2	120	1-5	ECN05A1AAA-R63/B
	460	2	120	1-5	ECN05A1AAA-R63/B
0	200, 230	3	120	1-5	ECN0501AAA-R63/B
	460	5	120	1-5	ECN0501AAA-R63/B
	200, 230	3	120	4-20	ECN0501AAA-R63/C
	460	5	120	4-20	ECN0501AAA-R63/C
1	200, 230	7-1/2	120	4-20	ECN0511AAA-R63/C
	460	10	120	4-20	ECN0511AAA-R63/C
2	200, 230	10	120	9-45	ECN0521AAA-R63/D
	460	25	120	9-45	ECN0521AAA-R63/D

NEMA combination, non-reversing starters, non-fusible disconnect Type 1

NEMA size	Motor voltage	Maximum hp rating	Magnet coil voltage	SSOL range	Catalog number
00	200, 230	1-1/2	120	1-5	ECN16A1AAA-R63/B
	460	2	120	1-5	ECN16A1AAA-R63/B
0	200, 230	3	120	1-5	ECN1601AAA-R63/B
	460	5	120	1-5	ECN1601AAA-R63/B
	200, 230	3	120	4-20	ECN1601AAA-R63/C
	460	5	120	4-20	ECN1601AAA-R63/C
1	200, 230	7-1/2	120	4-20	ECN1611AAA-R63/C
	460	10	120	4-20	ECN1611AAA-R63/C
2	200, 230	10	120	9-45	ECN1621AAA-R63/D
	460	25	120	9-45	ECN1621AAA-R63/D

Starters

NEMA enclosures with CPT modifications

To order an enclosure with CPT:

1. Change ECN05 to ECN07 for non-combination units, and ECN16 to ECN18 for combination units.
2. Change the “A” in the 7th catalog string to the correct letter based on the below table:

Catalog string letter	Primary	Secondary
E	208/60	120/60
B	240/480–220/440 wired for 240 V	120/60–110/50
C	240/480–220/440 wired for 480 V	120/60–110/50

NEMA accessories—CPT and fuse kits

Description	Catalog number
100 VA CPT kit (208/277 V primary, 120 V secondary)	C341CE
100 VA CPT kit (240/480 V primary, 120 V secondary)	C341CC
Fuse clip kit for combination starter—30 A / 250 V	C351KC21
Fuse clip kit for combination starter—30 A / 600 V and 60 A / 250 V	C351KD22-61

NEMA accessories—cover control kits

Description	Catalog number		
	Non-combination Type 1, size 00–2	Non-combination Type 1, size 3–5	Combination Type 1 and all Type 3R, 12, 4X
STOP/START pushbuttons	C600M1	C400GK1	C400T1
STOP/START pushbuttons with red RUN light (85–264 Vac)	C600M101A	C400GK12	—
HAND/OFF/AUTO selector switch	C600M12	C400GK3	C400T12
HAND/OFF/AUTO selector switch with red RUN light (85–264 Vac)	C600M121A	C400GK32	—

Catalog numbering system—enclosed lighting contactors

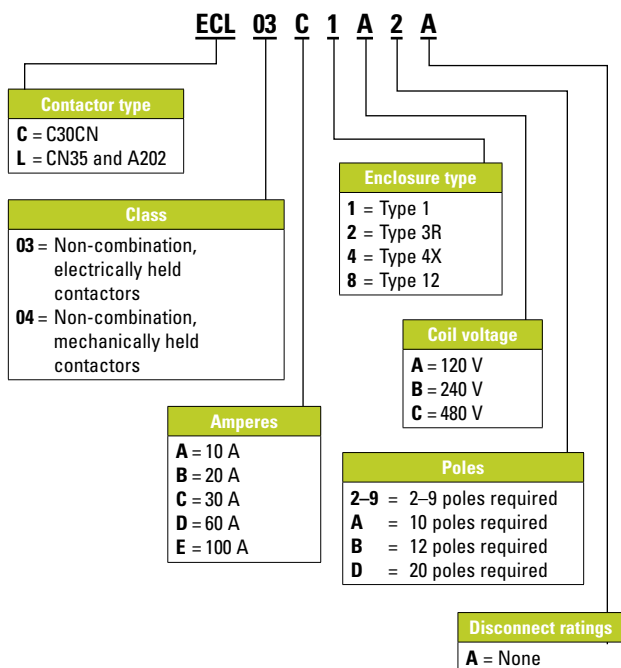

Lighting contactors

Lighting non-combination contactors, Type 1

Contactor type	Number of poles	Ampere rating	Coil voltage	Catalog number
C30CN, electrically held	2	30	120	ECC03C1A2A
C30CN, electrically held	4	30	120	ECC03C1A4A
C30CN, electrically held	6	30	120	ECC03C1A6A
CN35, electrically held	2	20	120	ECL03B1A2A
CN35, electrically held	4	20	120	ECL03B1A4A
CN35, electrically held	6	20	120	ECL03B1A6A

Questions to ask

Step

1

Q Do you need an assembled pushbutton station or loose components in clam-shell packaging?

A — Assembled pushbutton station
— Loose components in clam-shell package

Step

2

For pushbutton stations

Q What size of pushbutton station do you need?

A — 22 mm
— 30 mm

Q How many elements (operators) do you want?

A — 1
— 2
— 3

Step

3

For loose components

Q What type of operator do you need?

A — Emergency stop operator
— Momentary pushbutton
— Indicating light
— Illuminated pushbutton
— Selector switches

Pushbutton stations and pushbuttons

Pushbutton stations

30 mm pushbutton stations

Description	Catalog number
Single-element	
Emergency Off—break glass pushbutton station, NC	10250TGR
Man-Off-Auto selector switch pushbutton station, 2NO	10250T3524
Stop mushroom head pushbutton station, 1NC	10250T3519
Two-element	
Start-Stop pushbutton station, 1NO-2NC	10250T3525
Start-Stop rectangular pushbutton station, 1NO-1NC	10250H5200
Three-element	
Open-Close-Stop pushbutton station, 2NO-3NC	10250T3614
Up-Down-Stop rectangular pushbutton station, 2NO-1NC	10250H5301

22 mm pushbutton stations

Description	Catalog number
Single-element	
40 mm mushroom head push-pull emergency stop operator, NC	M22-C1-M1H
40 mm illuminated mushroom head push-pull emergency stop operator, 85–264 Vac, NO-NC	M22-C1-M2H
Two-element	
Flush pushbutton, Start-Stop, NO-NC	M22-C2-M2V
Flush pushbutton, Forward-Reverse, 2NO	M22-C2-M3V
Three-element	
Flush pushbutton, Open-Stop-Close, 2NO-1NC	M22-C3-M4V
Flush pushbutton, Forward-Stop-Reverse, 2NO-1NC	M22-C3-M5V
Flush pushbutton, Up-Stop-Down, 2NO-NC	M22-C3-M6V

Pushbutton components

Individually packaged 30 mm pushbuttons and operators NEMA 4, 4X, 12 13

Description	Catalog number
Emergency stop operator	
Red non-illuminated push-pull, 1NO-1NC, includes 2 legend plates: EMERG. STOP and STOP	10250T5B62-1-POP
Jumbo mushroom pushbutton, 1NO-1NC, button engraved EMERG. STOP (button is engraved—no legend plate provided)	10250T33-POP
Red mushroom pushbutton engraved EMERG. STOP, 1NO-1NC, includes 2 legend plates: EMERG. STOP and STOP	10250T32R-POP
Momentary pushbutton	
Black flush pushbutton, 1NO-1NC, includes 1 legend plate: START and JOG	10250T30B-POP
Red extended pushbutton, 1NO-1NC, includes 1 legend plate: STOP	10250T31R-POP
Indicating light	
Red indicating light transformer 120 Vac with two extra lenses (green and amber), 1NO-1NC, includes 2 legend plates: RUN and JOG	10250T34R-POP
Illuminated pushbutton	
Red illuminated pushbutton (120 Vac/Vdc), with 2 extra lenses (green and amber), 1NO-1NC, includes 1 legend plate: Power On	10250T411C21-1-POP
Selector switches	
Two-position selector switch, 1NO-1NC, includes 3 legend plates: Off/On, Hand/Auto and Run/Jog	10250T20KB-POP
Three-position selector switch, 2NO-2NC, includes 1 legend plate: Hand/Off/Auto	10250T22KB-POP
Three-position selector switch, 1NO-1NC, includes 1 legend plate: Hand/Off/Auto	10250T21KB-POP

Questions to ask

Step

1

Q What is the motor nameplate information?

- A**
- System (AC or DC) and voltage?
 - If AC, is the motor single-phase or three-phase?
 - What is the motor horsepower?

Step

2

Q What type of enclosure is needed?

- A**
- No enclosure (will be mounted in separate enclosure)
 - NEMA 1 enclosure

Step

3

Q Is overload protection required?

- A**
- No
 - Yes. If yes, what is the motor full load amperes (FLA)?

Step

4

Q What type of operator does the customer want?

- A**
- Button
 - Toggle

Manual starters

Manual starters

Manual motor switches without overload

Type	Pole config.	Maximum motor (hp)				Catalog number	
		120 V	240 V	480 V	230 V	Open	Enclosed
B230A	Two-pole	2	5	—	—	B230AN	B230AG
B230B	Two-pole	2	5	10	15	B230BND	B230BGD
	Three-pole	3	7.5	15	20	B330AND	B330AGD

Single-phase manual starters with overload protection— Type MS series starters ①

Pole config.	NEMA size	Maximum motor (hp)			Catalog number	
		AC voltage			Open	Enclosed ②
		120 Vac	240 Vac	277 Vac		
Single-pole	1	1	1	MST01	MST01SN1P	
Two-pole	1	1	1	MST02	MST02SN1P	

Pole config.	NEMA size	Maximum motor (hp)			Catalog number	
		DC voltage			Open	Enclosed ②
		120 Vdc	240 Vdc	32 Vdc		
Single-pole	¼	¼	¼	MST01	MST01SN1P	
Two-pole	¼	¼	¼	MST02	MST02SN1P	

① Use MSH heaters for MS series starters.

② With pilot light.

Single- and three-phase manual starters with overload protection— Type B100 ①

Pole config.	NEMA size	Maximum motor (hp)			Catalog number	
		AC voltage			Open	Enclosed ②
120 Vac	208–240 Vac	480–600 Vac				
Two-pole (single-phase)	0	1	2	—	B100M0B	B100S0B
	1	2	3	—	B100M1B	B100S1B
Three-pole (three-phase)	0	2	3	5	B100M0C	B100S0C
	1	3	7½	10	B100M1C	B100S1C

Pole config.	NEMA size	Maximum motor (hp)		Catalog number	
		DC voltage		Open	Enclosed ②
115 Vdc	230 Vdc				
Two-pole (single-phase)	0	1	1½	B100M0B	B100S0B
	1	1½	2	B100M1B	B100S1B
Three-pole (three-phase)	0	—	—	B100M0C	B100S0C
	1	—	—	B100M1C	B100S1C

① Use FH heaters for Type B100 starters.

② NEMA 1.

* At Eaton, we believe that power is a fundamental part of just about everything people do. Technology, transportation, energy and infrastructure—these are things the world relies on every day. That's why Eaton is dedicated to helping our customers find new ways to manage electrical, hydraulic and mechanical power more efficiently, safely and sustainably. To improve people's lives, the communities where we live and work, and the planet our future generations depend upon. Because that's what really matters. And we're here to make sure it works.

See more at [Eaton.com/whatmatters](https://www.eaton.com/whatmatters)

For more information, visit
[Eaton.com/powrstock](https://www.eaton.com/powrstock)

Eaton is a registered trademark.

All other trademarks are property of their respective owners.

Eaton
1000 Eaton Boulevard
Cleveland, OH 44122
United States
[Eaton.com](https://www.eaton.com)

© 2018 Eaton
All Rights Reserved
Printed in USA
Publication No. CA08307001E / Z20429
February 2018

EATON
Powering Business Worldwide

Pow-R-Stock^{Plus} quick selector reference guide

Frequently used distribution
and control products available
from distributor stock



EATON

Powering Business Worldwide

Table of contents



Pow-R-Stock panelboards

Questions to ask	5
Catalog numbering	6
Interiors, EZ Boxes and EZ Trims.....	8
Branch circuit breakers	10
Universal main circuit breaker kits— top or bottom mounting	11
Lug kits and accessories	13



Safety switches/ disconnects

Questions to ask	14
Catalog numbering	15
General-duty safety switches	16
Heavy-duty safety switches	17
Safety switch kits	18



Transformers

Questions to ask	19
Catalog numbering	20
General-purpose transformers.....	22
Sizing tables	24



Enclosed control

Questions to ask	25
Catalog numbering	26
NEMA non-combination, non-reversing starters, Type 1	26
NEMA combination, non-reversing starters, non-fusible disconnect, Type 1	26
NEMA accessories.....	27
Lighting contactors.....	28



Pushbutton stations and pushbuttons

Questions to ask	29
30 mm pushbutton stations	30
22 mm pushbutton stations	30
Individually packaged 30 mm pushbuttons and operators.....	31



Manual starters

- Questions to ask 32
- Manual motor switches without overload 33
- Single-phase manual starter with overload protection 33
- Single- and three-phase manual starters with
overload protection 33

Questions to ask

Step 1

1

Select an interior

Q What is your voltage?

A — 120/240 V single-phase, three-wire
— 208Y/120 V three-phase, four-wire
— 480Y/277 V three-phase, four-wire

Q What is your busbar rating?

A — 100 A (aluminum or copper)
— 225 A (aluminum or copper)
— 400 A (aluminum or copper)
— 600 A (aluminum or copper)

Q What is the number of branch circuits/poles?

A — 18
— 30
— 42

Step 2

2

Enclosure type

Q What enclosure is required?

A — NEMA® 1 indoor
— NEMA 3R outdoor

Step 3

3

Trim type

Q For NEMA 1 indoor panels, will the panel be mounted recessed in the wall or mounted directly to the wall?

A — Flush
— Surface

Step 4

4

Q What is the cable entry locations for the incoming feeder?

A — Top
— Bottom

Step 5

5

Main device

Q Main lugs only (MLO) or main circuit breaker?

A — MLO
— MCB (choose amperage and top or bottom)

Pow-R-Stock panelboards (unassembled)

Catalog numbering system— Pow-R-Stock panelboard interiors

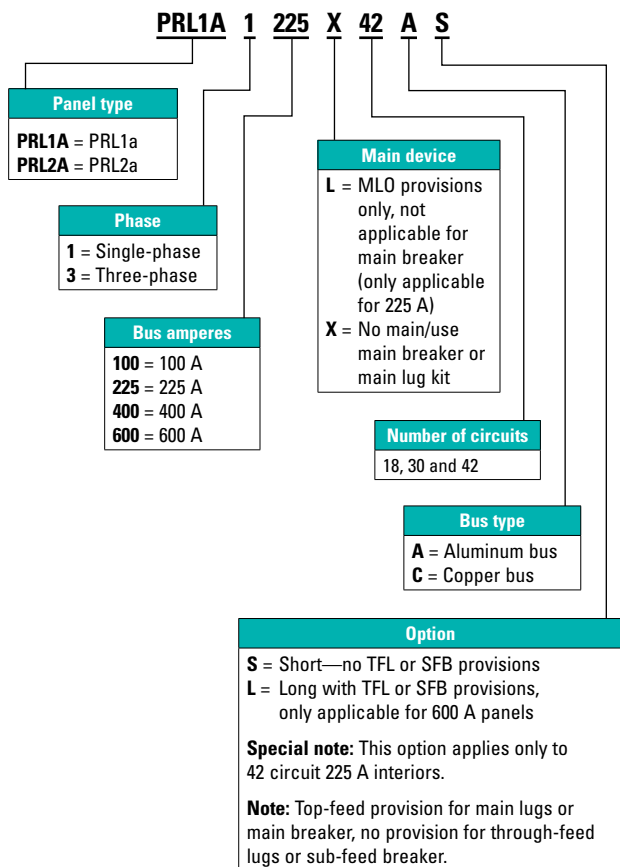

Catalog numbering system— EZ Panel factory-assembled stock panelboards

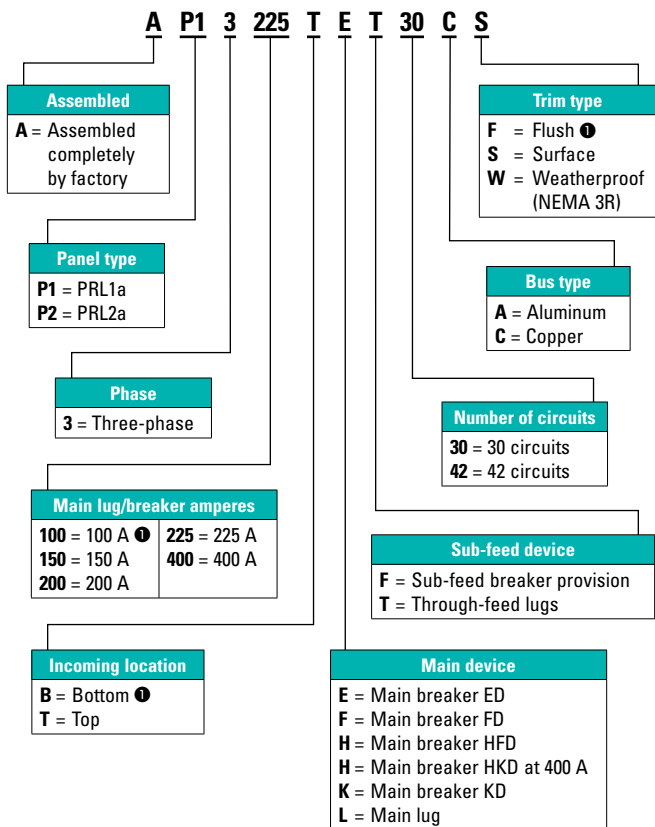

❶ These items are not part of the initial launch. Please consult VISTA or your Eaton sales engineer for product availability.

Notes: Not all combinations may be valid. Please verify availability of catalog number created. Refer to PA014007EN for more information on the EZ Panel.

Pow-R-Stock panelboards—EZ™ Boxes and EZ Trims

Ampere rating	Max. number of poles	Capability				Sub-feed breaker (225 A max.)	Catalog numbers
		Main lugs	Main breaker	Through-feed lugs	Interiors (less main device)		
					Aluminum bus		
Single-phase, three-wire 120/240 Vac							
100	18	■	■	■	N/A	PRL1A1100X18A	
100	30	■	■	■	100	PRL1A1100X30A	
100	42	■	■	■	N/A	PRL1A1100X42A	
225	30	■	■	■	100, 125, 150, 175, 200, 225	PRL1A1225X30A	
225	42	■	■	N/A	N/A	PRL1A1225X42AS ❶	
225	42	■	■	■	100, 125, 150, 175, 200, 225	PRL1A1225X42A	
400	42	■	■	N/A	N/A	PRL1A1400X42AS ❶	
400	42	■	■	■	100, 125, 150, 175, 200, 225	PRL1A1400X42A	
600	42	■	■	■	N/A		
600	42	■	■	■	100, 125, 150, 175, 200, 225, 250, 300, 350, 400		
Three-phase, four-wire 208Y/120 Vac							
100	18	■	■	■	N/A	PRL1A3100X18A	
100	30	■	■	■	100	PRL1A3100X30A	
100	42	■	■	■	N/A	PRL1A3100X42A	
225	30	■	■	■	100, 125, 150, 175, 200, 225	PRL1A3225X30A	
225	42	■	N/A	N/A	N/A	PRL1A3225L42AS ❶	
225	42	■	■	N/A	N/A	PRL1A3225X42AS ❶	
225	42	■	■	■	100, 125, 150, 175, 200, 225	PRL1A3225X42A	
400	42	■	■	N/A	N/A	PRL1A3400X42AS ❶	
400	42	■	■	■	100, 125, 150, 175, 200, 225	PRL1A3400X42A	
600	42	■	■	■	N/A		
600	42	■	■	■	100, 125, 150, 175, 200, 225, 250, 300, 350, 400		
Three-phase, four-wire 480Y/277 Vac							
100	18	■	■	■	N/A	PRL2A3100X18A	
100	30	■	■	■	100	PRL2A3100X30A	
100	42	■	■	■	N/A	PRL2A3100X42A	
225	30	■	■	■	100, 125, 150, 175, 200, 225	PRL2A3225X30A	
225	42	■	N/A	N/A	N/A	PRL2A3225L42AS ❶	
225	42	■	■	N/A	N/A	PRL2A3225X42AS ❶	
225	42	■	■	■	100, 125, 150, 175, 200, 225	PRL2A3225X42A	
400	42	■	■	N/A	N/A	PRL2A3400X42AS ❶	
400	42	■	■	■	100, 125, 150, 175, 200, 225	PRL2A3400X42A	
600	42	■	■	■	N/A		
600	42	■	■	■	100, 125, 150, 175, 200, 225, 250, 300, 350, 400		

❶ S = Short—no TFL or SFB provisions.

Copper bus	Boxes	Trims (NEMA 1)		NEMA 3R enclosures
	NEMA 1	Surface	Flush	
PRL1A1100X18C	EZB2036R	EZT2036S	EZT2036F	GWPBQ2036PR
PRL1A1100X30C	EZB2048R	EZT2048S	EZT2048F	GWPBQ2048PR
PRL1A1100X42C	EZB2048R	EZT2048S	EZT2048F	GWPBQ2048PR
PRL1A1225X30C	EZB2048R	EZT2048S	EZT2048F	GWPBQ2048PR
PRL1A1225X42CS ①	EZB2048R	EZT2048S	EZT2048F	GWPBQ2048PR
PRL1A1225X42C	EZB2060R	EZT2060S	EZT2060F	GWPBQ2060PR
PRL1A1400X42CS ①	EZB2060R	EZT2060S	EZT2060F	GWPBQ2060PR
PRL1A1400X42C	EZB2072R	EZT2072S	EZT2072F	GWPBQ2072PR
PRL1A1600X42C	EZB2072R	EZT2072S	EZT2072F	GWPBQ2072PR
PRL1A1600X42CL	EZB2090R	EZT2090S	EZT2090F	GWPBQ2090PR
PRL1A3100X18C	EZB2036R	EZT2036S	EZT2036F	GWPBQ2036PR
PRL1A3100X30C	EZB2048R	EZT2048S	EZT2048F	GWPBQ2048PR
PRL1A3100X42C	EZB2048R	EZT2048S	EZT2048F	GWPBQ2048PR
PRL1A3225X30C	EZB2048R	EZT2048S	EZT2048F	GWPBQ2048PR
PRL1A3225L42CS ①	EZB2042R	EZT2042S	EZT2042F	GWPBQ2042PR
PRL1A3225X42CS ①	EZB2048R	EZT2048S	EZT2048F	GWPBQ2048PR
PRL1A3225X42C	EZB2060R	EZT2060S	EZT2060F	GWPBQ2060PR
PRL1A3400X42CS ①	EZB2060R	EZT2060S	EZT2060F	GWPBQ2060PR
PRL1A3400X42C	EZB2072R	EZT2072S	EZT2072F	GWPBQ2072PR
PRL1A3600X42C	EZB2072R	EZT2072S	EZT2072F	GWPBQ2072PR
PRL1A3600X42CL	EZB2090R	EZT2090S	EZT2090F	GWPBQ2090PR
PRL2A3100X18C	EZB2036R	EZT2036S	EZT2036F	GWPBQ2036PR
PRL2A3100X30C	EZB2048R	EZT2048S	EZT2048F	GWPBQ2048PR
PRL2A3100X42C	EZB2048R	EZT2048S	EZT2048F	GWPBQ2048PR
PRL2A3225X30C	EZB2048R	EZT2048S	EZT2048F	GWPBQ2048PR
PRL2A3225L42CS ①	EZB2042R	EZT2042S	EZT2042F	GWPBQ2042PR
PRL2A3225X42CS ①	EZB2048R	EZT2048S	EZT2048F	GWPBQ2048PR
PRL2A3225X42C	EZB2060R	EZT2060S	EZT2060F	GWPBQ2060PR
PRL2A3400X42CS ①	EZB2060R	EZT2060S	EZT2060F	GWPBQ2060PR
PRL2A3400X42C	EZB2072R	EZT2072S	EZT2072F	GWPBQ2072PR
PRL2A3600X42C	EZB2072R	EZT2072S	EZT2072F	GWPBQ2072PR
PRL2A3600X42CL	EZB2090R	EZT2090S	EZT2090F	GWPBQ2090PR

Note: The colors shown in the tables correspond to the color coding on the trim, interior and box product packaging labels. Be sure that all three parts match when delivering to your customer.

Note: Distributors can purchase boxes in quantities via the Distributor toolbox.

Branch circuit breakers

Summary of branch breakers available

Breaker	No. of poles	Ampere rating	Voltage	kAIC rating	Example	Panel type
BAB ①②	1	15–70	120	10	BAB1020	PRL1a
	2	15–100	120/240	10	BAB2020	PRL1a
	2	15–100	240	10	BAB2040H	PRL1a
	3	15–100	240	10	BAB3030H	PRL1a
QBAF	1	15–20	120	10	QBAF1020	PRL1a
QBHAF	1	15–20	120	22	QBHAF1020	PRL1a
QBCAF	1	15–20	120	10	QBCAF1020	PRL1a
QBHCAF	1	15–20	120	22	QBHCAF1020	PRL1a
QBGFT	1	15–40	120	10	QBGFT1020	PRL1a
	2	15–50	120/240	10	QBGFT2040	PRL1a
QBHGFT	1	15–30	120	22	QBHGFT1020	PRL1a
	2	15–30	120/240	22	QBHGFT2020	PRL1a
QBGFEP	1	15–40	120	10	QBGFEP1020	PRL1a
	2	15–50	120/240	10	QBGFEP2020	PRL1a
QBHGFEF	1	15–30	120	22	QBHGFEF1020	PRL1a
	2	15–30	120/240	22	QBHGFEF2020	PRL1a
QBHW ①	1	15–70	120	22	QBHW1020	PRL1a
	2	15–100	120/240	22	QBHW2020	PRL1a
	2	15–100	240	22	QBHW2040H	PRL1a
	3	15–100	240	22	QBHW3030H	PRL1a
GHQ ①	1	15–20	277	14	GHQ1020	PRL2a
GHB ①②	1	15–100	277	14	GHB1020	PRL2a
	2	15–100	480Y/277	14	GHB2040	PRL2a
	3	15–100	480Y/277	14	GHB3060	PRL2a

① BAB, QBHW, GHQ and GHB breakers installed in PRL1a and PRL2a are available with shunt trip, i.e., BAB1020S.

② BAB-H and GHB 50–100 A available as chassis-mounted main device.

Universal main circuit breaker kits— top or bottom mounting

Kits—main circuit breaker (includes circuit breaker and terminals)

Max. volt.	Ampere rating	Service	Breaker frame	Mounting location	Wire range Al/Cu (in kcmil)	Catalog number
240 Vac	100	Single- or three-phase	ED	Universal	(1) #14–1/0	BKED100
	125	Single- or three-phase	ED	Universal	(1) #4–4/0	BKED125
	150	Single- or three-phase	ED	Universal	(1) #4–4/0	BKED150
	175	Single- or three-phase	ED	Universal	(1) #4–4/0 ①	BKED175
	200	Single- or three-phase	ED	Universal	(1) #4–4/0 ①	BKED200
	225	Single- or three-phase	ED	Universal	(1) #4–4/0 ①	BKED225
480 Vac	100	Single- or three-phase	FD	Universal	(1) #14–1/0	BKFD100
	110	Single- or three-phase	FD	Universal	(1) #4–4/0	BKFD110
	125	Single- or three-phase	FD	Universal	(1) #4–4/0	BKFD125
	150	Single- or three-phase	FD	Universal	(1) #4–4/0	BKFD150
	175	Single- or three-phase	FD	Universal	(1) #4–4/0 ①	BKFD175
	200	Single- or three-phase	FD	Universal	(1) #4–4/0 ①	BKFD200
	225	Single- or three-phase	FD	Universal	(1) #4–4/0 ①	BKFD225
480 Vac	100	Single- or three-phase	HFD	Universal	(1) #14–1/0	BKHFD100
	110	Single- or three-phase	HFD	Universal	(2) #4–4/0	BKHFD110
	125	Single- or three-phase	HFD	Universal	(2) #4–4/0	BKHFD125
	150	Single- or three-phase	HFD	Universal	(2) #4–4/0	BKHFD150
	175	Single- or three-phase	HFD	Universal	(2) #4–4/0	BKHFD175
	200	Single- or three-phase	HFD	Universal	(2) #4–4/0	BKHFD200
	225	Single- or three-phase	HFD	Universal	(2) #4–4/0	BKHFD225
480 Vac	250	Single- or three-phase	KD	Universal	(1) 250–500	BKKD250
	300	Single- or three-phase	KD	Universal	(1) 250–500	BKKD300
	350	Single- or three-phase	KD	Universal	(1) 250–500	BKKD350
	400	Single- or three-phase	KD	Universal	(2) 3/0–250 or (1) 3/0–500	BKKD400

① Order optional lug kit catalog no. 3TA225FDK for 175–225 A ED- and FD-Frame three-pole circuit breakers to provide terminations for (1) #6–300 kcmil.

Note: KD kits are to be used on 400 A and 600 A panels only.

Universal main circuit breaker kits— top or bottom mounting

Kits—main circuit breaker (includes circuit breaker and terminals)

Max. volt.	Ampere rating	Service	Breaker frame	Mounting location	Wire range Al/Cu (in kcmil)	Catalog number
480 Vac	250	Single- or three-phase	HKD	Universal	(1) 250–500	BKHKD250
	300	Single- or three-phase	HKD	Universal	(1) 250–500	BKHKD300
	350	Single- or three-phase	HKD	Universal	(1) 250–500	BKHKD350
	400	Single- or three-phase	HKD	Universal	(1) 250–500	BKHKD400
480 Vac	400	Single- or three-phase	LG	Universal	(1) #2–500	BKLGE400
	500	Single- or three-phase	LG	Universal	(2) #2–500	BKLGE500
	600	Single- or three-phase	LG	Universal	(2) #2–500	BKLGE600

Lug kits and accessories

Standard main/sub-feed breaker lug capacities

Ampere rating	Lug wire range Al/Cu
100	(1) #14–1/0
125–225	(1) #4–4/0
250–350	(1) 250–500 kcmil
400	(2) 3/0–250 kcmil or (1) 3/0–500 kcmil

Main/through-feed lug kits

Ampere rating	Wire range Al/Cu	Catalog number
100	(1) #14–1/0	LUGKIT100
225	(1) #6–300 kcmil	LUGKIT225
400	(2) #2–500 kcmil	LUGKIT400
600	(2) #2–500 kcmil	LUGKIT600

Kits

Description	Catalog number		
	100 A	225 A	400/600 A
Service entrance kit—MLO	SEK1/2 ①	SEK1/2 ①	SEK4/6 ①
Service entrance kit—MCB	SEKB ②④ SEKG ③④	SEKF ④⑤	SEKKL ④⑥
200% neutral kit	2NK100	2NK225	1NK400
Sub-feed breaker adapter (used to mount 225 A sub-feed breaker in 400 A panels)	—	—	225ASFBKIT
Sub-feed breaker adapter (used to mount 225 A sub-feed breaker in 600 A panels)	—	—	225BSFBKIT
Sub-feed breaker adapter (used to mount 400 A sub-feed breaker in 600 A panels)	—	—	400ASFBKIT

① Applicable for use with MLO, SE panels only.

② Only applicable for SE PRL1a with chassis-mounted BAB, QBH main breaker.

③ Only applicable for SE PRL2a with chassis-mounted GHB main breaker.

④ Main breaker panels only—includes barrier kit and bonding jumper.

⑤ To be used with F-frame main breaker.

⑥ To be used with K- and L-frame main breaker.

Accessories

Description	Catalog number
Isolated ground bar kit	ISOGROUND
Copper ground bar kit	CUGROUND
1P filler plate ①	5155C62H01
Series rating kit ②	SRK

① Each PRS panel comes with 50% filler plates, e.g., 18 circuit interior contains 9 filler plates.

② Series rating kit includes series rating book and adhesive sleeve and series rating sticker. If panelboard is being series rated higher than the base rating, an SRK is required.

Questions to ask

Step 1

1

Q Which type of switch do you need?

- A**
- Heavy-duty (DH)
 - General-duty (DG)
 - Double-throw (DT)

Step 2

2

Q What current (ampere) rating do you need?

- A**
- 30, 60, 100, 200, 400, 600, 800, 1200

Step 3

3

Q Should it be fused, non-fused or fusible with neutral?

- A**
- F = Fusible without neutral
 - U = Non-fusible
 - N = Fusible with neutral

Step 4

4

Q How many poles?

- A**
- 1, 2, 3, 4, 6

Step 5

5

Q Choose the maximum circuit voltage.

- A**
- 240 Vac
 - 600 Vac

Step 6

6

Q What type of enclosure do you need?

- A**
- NEMA 1
 - NEMA 3R
 - NEMA 12
 - NEMA 4 painted steel
 - NEMA 4X stainless steel
 - NEMA 4X non-metallic

Safety switches/ disconnects

Catalog numbering system—safety switches

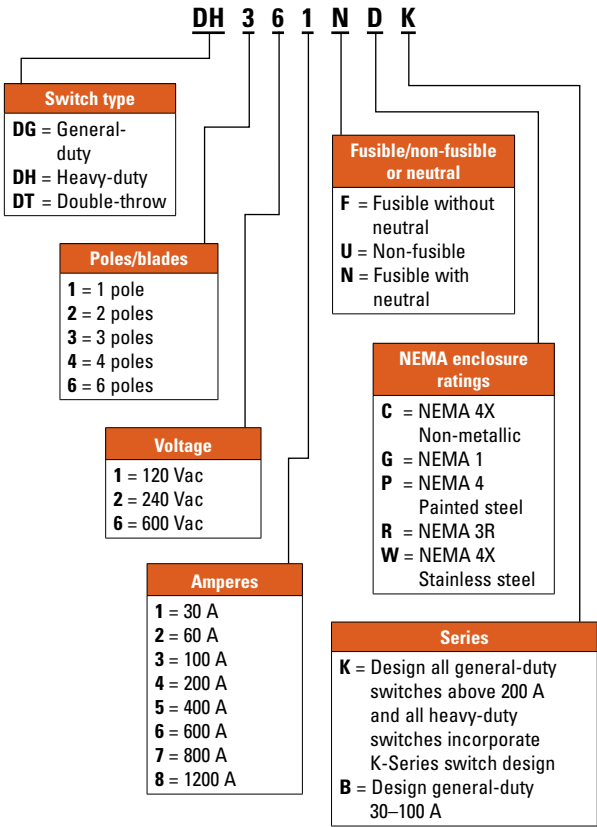

General-duty safety switches (disconnects)

Two-pole—240 Vac (suitable for service entrance use with a neutral or ground kit)

Current rating (amps)	Type	Enclosure type	Max. hp ratings		Catalog number
			Single-phase		
			120 Vac	240 Vac	
30	Fusible with neutral	NEMA 1		1.5–3	DG221NGB
30	Non-fusible	NEMA 1	2	3	DG221UGB
30	Fusible with neutral	NEMA 3R		1.5–3	DG221NRB
30	Non-fusible	NEMA 3R	2	3	DG221URB
60	Fusible with neutral	NEMA 1		3–10	DG222NGB
60	Non-fusible	NEMA 1	3	10	DG222UGB
60	Fusible with neutral	NEMA 3R		3–10	DG222NRB
60	Non-fusible	NEMA 3R	1	10	DG222URB
100	Fusible with neutral	NEMA 1		7.5–15	DG223NGB
100	Non-fusible	NEMA 1		15	DG223UGB
100	Fusible with neutral	NEMA 3R		7.5–15	DG223NRB
100	Non-fusible	NEMA 3R		15	DG223URB

Three-pole—240 Vac (suitable for service entrance use with a neutral or ground lug kit)

Current rating (amps)	Type	Enclosure type	Max. hp ratings ①		Catalog number
			Single-phase	Three-phase	
			240 Vac	240 Vac	
30	Fusible with neutral	NEMA 1	1.5–3	3–7.5	DG321NGB
30	Non-fusible	NEMA 1	3	7.5	DG321UGB
30	Fusible with neutral	NEMA 3R	1.5–3	3–7.5	DG321NRB
30	Non-fusible	NEMA 3R	3	7.5	DG321URB
60	Fusible with neutral	NEMA 1	3–10	7.5–15	DG322NGB
60	Non-fusible	NEMA 1	10	15	DG322UGB
60	Fusible with neutral	NEMA 3R	3–10	7.5–15	DG322NRB
60	Non-fusible	NEMA 3R	10	15	DG322URB
100	Fusible with neutral	NEMA 1	7.5–15	15–30	DG323NGB
100	Non-fusible	NEMA 1	15	30	DG323UGB
100	Fusible with neutral	NEMA 3R	7.5–15	15–30	DG323NRB
100	Non-fusible	NEMA 3R	15	30	DG323URB

① Maximum hp ratings for fusible units apply only when dual element time-delay fuses are used.

Neutral and ground lug kits

Description	Catalog number
Neutral kit for 30 A switches	DG030NB
Neutral kit for 60–100 A switches	DG100NB
Ground lug kit for 30–100 A switches	DG030GB

Class R fuse adapter kits

Ampere rating	Type	Voltage	Catalog number
30	General-duty	240	DG30RB
60	General-duty	240	DS16FK
100	General-duty	240	DG100RB

Heavy-duty safety switches (disconnects)

Three-pole—480–600 Vac (suitable for service entrance use with a neutral or ground lug kit below)

Current rating (amps)	Type	Enclosure type	Max. hp ratings				Catalog number
			Single-phase		Three-phase		
			480 V	600 V	480 V	600 V	
30	Fusible	NEMA 1	7.5	15	10	20	DH361FGK ❶
30	Non-fusible	NEMA 1	7.5	15	10	20	DH361UGK
30	Fusible	NEMA 3R	7.5	15	10	20	DH361FRK ❶
30	Non-fusible	NEMA 3R	7.5	15	10	20	DH361URK
30	Fusible	NEMA 4X	7.5	10	15	20	DH361FWK ❶
30	Non-fusible	NEMA 4X	7.5	10	20	30	DH361UWK
60	Fusible	NEMA 1	20	30	25	50	DH362FGK
60	Non-fusible	NEMA 1	20	30	25	50	DH362UGK
60	Fusible	NEMA 3R	20	30	25	50	DH362FRK
60	Non-fusible	NEMA 3R	20	30	25	50	DH362URK
60	Fusible	NEMA 4X	20	25	30	50	DH362FWK
60	Non-fusible	NEMA 4X	20	25	50	60	DH362UWK
100	Fusible	NEMA 1	30	60	40	75	DH363FGK
100	Non-fusible	NEMA 1	30	60	40	75	DH363UGK
100	Fusible	NEMA 3R	30	60	40	75	DH363FRK
100	Non-fusible	NEMA 3R	30	60	40	75	DH363URK
100	Fusible	NEMA 4X	30	40	60	75	DH363FWK
100	Non-fusible	NEMA 4X	40	50	75	100	DH363UWK
200	Fusible	NEMA 1	50	125	50	150	DH364FGK
200	Non-fusible	NEMA 1	50	125	50	150	DH364UGK
200	Fusible	NEMA 3R	50	125	50	150	DH364FRK
200	Non-fusible	NEMA 3R	50	125	50	150	DH364URK
200	Fusible	NEMA 4X	50	50	125	150	DH364FWK
200	Non-fusible	NEMA 4X	50	50	125	125	DH364UWK

❶ For 30 A switches requiring Class J fusing, switch must be ordered with the Class J clips from the factory by adding a suffix "J" on the end.

Safety switch kits

Neutral and ground lug kits ①

Description	Catalog number
Neutral kit for 30–60 A switches	DH030NK
Neutral kit for 100 A switches	DH100NK
Neutral kit for 200 A switches	DG200NK
Ground lug kit for 30–100 A switches	DS100GK
Ground lug kit for 200 A switches	DS200GK

- ① A factory-installed ground lug is supplied on all NEMA 4, 4X and 12 safety switches, as well as all 400 A and higher NEMA 1 and 3R safety switches. A factory-installed ground lug is also supplied on all heavy-duty NEMA 1 and 3R 30–200 A switches that do not have a factory installed neutral.

Class R fuse adapter kits

Ampere rating	Type	Voltage	Catalog number
30	Heavy-duty	600	DS16FK
60	Heavy-duty	600	DS26FK
100	Heavy-duty	600	DS36FK
200	Heavy-duty	600	DS346FK

Class J fuse adapter kit ①

Ampere rating	Type	Voltage	Catalog number
60	Heavy-duty	600	DS26JK

- ① 30 A switches must be ordered from the factory with Class J fuse provisions by adding suffix “J” at the end of the switch catalog number. 100 A and 200 A switches can be field modified by moving the load side fuse base.

Questions to ask

Step 1

1

Q How many phases?

A — Single-phase
— Three-phase

Step 2

2

Q What type of enclosure is required?

A — Ventilated
— Encapsulated

Step 3

3

Q What is the primary voltage? (input voltage)

A — Single-phase is 240 V x 480 V
— Three-phase is 480 V delta (three-phase, three-wire)

Step 4

4

Q What is the secondary voltage? (output voltage)

A — Single-phase
— 120/240

— Three-phase
— 208Y/120 (three-phase, four-wire) or 240 V delta

Step 5

5

Q What kVA transformer is required?

A — If single-phase encapsulated, kVAs are:
0.05, 0.075, 0.1, 0.15, 0.25, 0.5, 0.75, 1,
1.5, 2, 3, 5, 7.5, 10, 15, 25, 37.5
— If single-phase ventilated, kVAs are:
15, 25, 37.5, 50, 75, 100, 167
— If three-phase encapsulated, kVAs are:
3, 6, 9, 15, 30, 45, 75
— If three-phase ventilated, kVAs are:
15, 30, 45, 75, 112.5, 150, 225, 300

Step 6

6

Q If a ventilated transformer was selected

A — Field kits: lug kits or weathershields
— Select from selection tables

Transformers

Catalog numbering system—DOE 2016 ventilated transformers

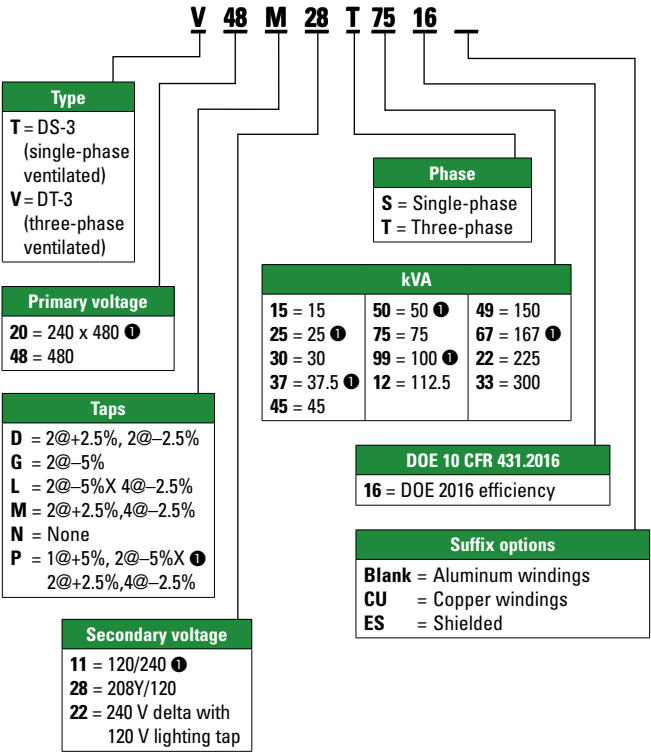

① Typically used with single-phase transformers.

Catalog numbering system—encapsulated transformers

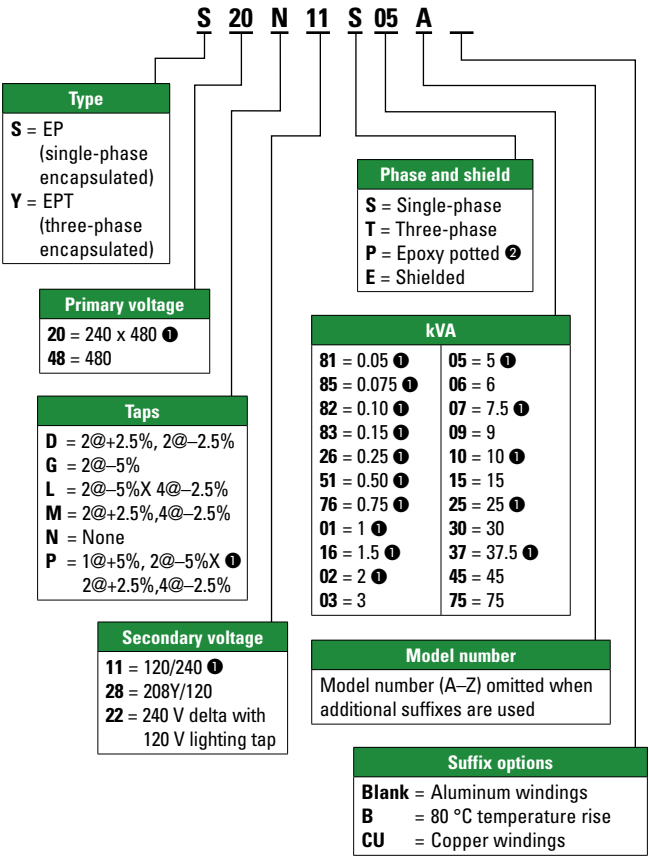

❶ Typically used with single-phase transformers.

❷ Single-phase 0.25–2 kVA encapsulated transformers only.

General-purpose transformers

Three-phase ventilated, 480 delta—208 Y/120, 150 °C rise, aluminum windings, DOE 2016

kVA	Frame number	Wiring diagram	Weathershield	Typical lug kit	Catalog number
15	939	280B	WS57	LKS1	V48M28T1516 ①
30	940	280B	WS58	LKS1	V48M28T3016 ①
45	940	280B	WS58	LKS1	V48M28T4516 ①
75	942	280B	WS59	LKS2	V48M28T7516 ②
112.5	943	280B	WS60	LKS2	V48M28T1216 ②
150	943	280B	WS60	LKS3	V48M28T4916 ②
225	944	280B	WS61	LKS3	V48M28T2216
300	945	280B	WS62	LKS3	V48M28T3316

① Suitable for use with wall-mounted bracket WMB05.

② Suitable for use with wall-mounted bracket WMB04.

Three-phase ventilated, 480 delta—240/120 lighting tap, 150 °C rise, aluminum windings, DOE 2016

kVA	Frame number	Wiring diagram	Weathershield	Typical lug kit	Catalog number
15	939	282B	WS57	LKS1	V48M22T1516 ①
30	940	282B	WS58	LKS1	V48M22T3016 ①
45	940	282B	WS58	LKS1	V48M22T4516 ①
75	942	282B	WS59	LKS2	V48M22T7516 ②
112.5	943	282B	WS60	LKS2	V48M22T1216 ②
150	943	282B	WS60	LKS3	V48M22T4916 ②
225	944	282B	WS61	LKS3	V48M22T2216
300	945	282B	WS62	LKS3	V48M22T3316

① Suitable for use with wall-mounted bracket WMB05.

② Suitable for use with wall-mounted bracket WMB04.

Three-phase encapsulated, 480 delta—208 Y/120, 115 °C rise

kVA	Frame number	Wiring diagram	Catalog number
3	201	70A	Y48G28T03N
6	200	70A	Y48G28T06N
9	103	70A	Y48G28T09N
15	95	72B	Y48D28T15N
30	243	84A	Y48M28T30N
45	244	84A	Y48M28T45N
75	245	84A	Y48M28T75N

Note: For frame drawings and wiring diagrams, refer to www.eaton.com/transformers.

General-purpose transformers

Single-phase ventilated, 240 x 480–120/240, 150 °C rise, aluminum windings, DOE 2016

kVA	Frame number	Wiring diagram	Weathershield	Typical lug kit	Catalog number
15	842	3XA	WS45	LKS1	T20P11S1516 ①
25	842	3XA	WS45	LKS1	T20P11S2516 ①
37.5	843	3XA	WS43	LKS1	T20P11S3716
50	843	3XA	WS43	LKS2	T20P11S5016
75	844	3XA	WS44	LKS2	T20P11S7516
100	844	3XA	WS44	LKS3	T20P11S9916
167	814	288A	WS13	LKS3	T48P11S6716 ②

① Suitable for use with wall-mounted bracket WMB01.

② 480 V primary only.

Single-phase encapsulated 240 x 480–120/240, 115 °C rise

kVA	Frame number	Wiring diagram	Catalog number
0.05	52	3A	S20N11S81N
0.075	53	3A	S20N11S85N
0.1	54	3A	S20N11S82N
0.15	55	3A	S20N11S83N
0.25	57P	3A	S20N11P26P
0.5	57P	3A	S20N11P51P
0.75	58P	3A	S20N11P76P
1	67P	3A	S20N11P01P
1.5	67P	3A	S20N11P16P
2	68P	3A	S20N11P02P
3	176	3A	S20N11S03N
5	177	3A	S20N11S05N
7.5	178	3A	S20N11S07N
10	179	3A	S20N11S10N
15	180	3A	S20N11S15N
25	182	23A	S20L11S25N
37.5	300A	248A	S20L11S37

Note: For frame drawings and wiring diagrams, refer to www.eaton.com/transformers.

General-purpose transformers sizing tables

Three-phase transformer full load current

kVA	Rated line-line voltage						
	208	240	480	600	2400	4160	4800
3	8.3	7.2	3.6	2.9	0.7	0.4	0.4
6	16.7	14.4	7.2	5.8	1.4	0.8	0.7
9	25.0	21.7	10.8	8.7	2.2	1.2	1.1
15	41.6	36.1	18.0	14.4	3.6	2.1	1.8
30	83.3	72.2	36.1	28.9	7.2	4.2	3.6
45	124.9	108.3	54.1	43.3	10.8	6.2	5.4
75	208.2	180.4	90.2	72.2	18.0	10.4	9.0
112.5	312.3	270.6	135.3	108.3	27.1	15.6	13.5
150	416.4	360.9	180.4	144.3	36.1	20.8	18.0
225	624.6	541.3	270.6	216.5	54.1	31.2	27.1
300	832.7	721.7	360.9	288.7	72.2	41.6	36.1
500	1387.9	1202.8	601.4	481.1	120.3	69.4	60.1
750	2081.9	1804.3	902.1	721.7	180.4	104.1	90.2
1000	2775.8	2405.7	1202.8	962.3	240.6	138.8	120.3

Note: Line current = (kVA x 1000) / (line voltage x 1.732).

Single-phase transformer full load current

kVA	Rated line-line voltage								
	120	208	240	277	480	600	2400	4160	4800
0.5	4.2	2.4	2.1	1.8	1.0	0.8	0.2	0.1	0.1
1	8.3	4.8	4.2	3.6	2.1	1.7	0.4	0.2	0.2
1.5	12.5	7.2	6.3	5.4	3.1	2.5	0.6	0.4	0.3
2	16.7	9.6	8.3	7.2	4.2	3.3	0.8	0.5	0.4
3	25.0	14.4	12.5	10.8	6.3	5.0	1.3	0.7	0.6
5	41.7	24.0	20.8	18.1	10.4	8.3	2.1	1.2	1.0
7.5	62.5	36.1	31.3	27.1	15.6	12.5	3.1	1.8	1.6
10	83.3	48.1	41.7	36.1	20.8	16.7	4.2	2.4	2.1
15	125.0	72.1	62.5	54.2	31.3	25.0	6.3	3.6	3.1
25	208.3	120.2	104.2	90.3	52.1	41.7	10.4	6.0	5.2
37.5	312.5	180.3	156.3	135.4	78.1	62.5	15.6	9.0	7.8
50	416.7	240.4	208.3	180.5	104.2	83.3	20.8	12.0	10.4
75	625.0	360.6	312.5	270.8	156.3	125.0	31.3	18.0	15.6
100	833.3	480.8	416.7	361.0	208.3	166.7	41.7	24.0	20.8
167	1391.7	802.9	695.8	602.9	347.9	278.3	69.6	40.1	34.8
250	2083.3	1201.9	1041.7	902.5	520.8	416.7	104.2	60.1	52.1
333	2775.0	1601.0	1387.5	1202.2	693.8	555.0	138.8	80.0	69.4

Note: Line current = (kVA x 1000) / line voltage.

Questions to ask

Step 1

1

Q What type of enclosure do you need?

- A**
- NEMA 1 (general-duty)
 - NEMA 3R (rain-tight)
 - NEMA 12 (dust-tight)
 - NEMA 4X (wash-down)

Step 2

2

Q What type of starter do you need?

- A**
- NEMA non-combination
 - NEMA combination, non-fusible or fusible
 - NEMA combination, breaker
 - Lighting contactor

Step 3

3

Q What is the horsepower and voltage of the motor?
(Note: this will determine the NEMA starter size)

- A**
- Horsepower: 1, 5, 10, 25 hp etc.
 - Motor voltage: 200, 230, 460, 575 V

Step 4

4

Q What is the control voltage for the coil?

- A**
- 120 Vac
 - 240 Vac
 - 480 Vac

Step 5

5

Q What size overload relay is needed?

- A**
- 1–5 FLA
 - 4–20 FLA
 - 9–45 FLA

Step 6

6

Q What additional accessories do you need?

- A**
- Cover control kits, such as HAND/OFF/AUTO selector switch or STOP/START pushbuttons
 - CPT kits
 - Fuse kits

Enclosed control

Catalog numbering system—non-combination and combination NEMA enclosed starters

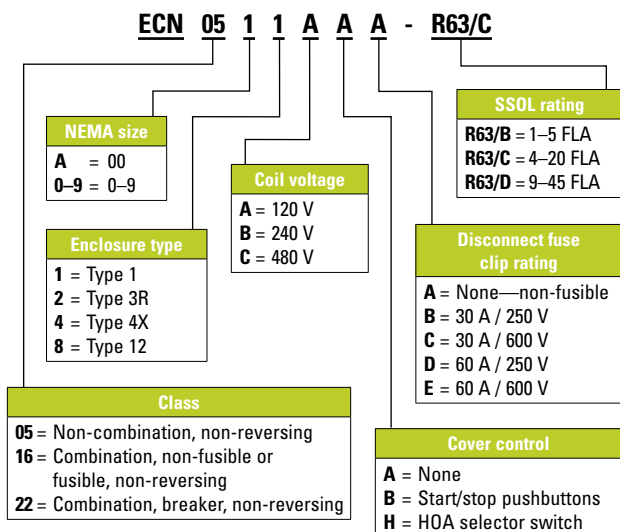

Starters

NEMA non-combination, non-reversing starters, Type 1

NEMA size	Motor voltage	Maximum hp rating	Magnet coil voltage	SSOL range	Catalog number
00	200, 230	1-1/2	120	1-5	ECN05A1AAA-R63/B
	460	2	120	1-5	ECN05A1AAA-R63/B
0	200, 230	3	120	1-5	ECN0501AAA-R63/B
	460	5	120	1-5	ECN0501AAA-R63/B
	200, 230	3	120	4-20	ECN0501AAA-R63/C
	460	5	120	4-20	ECN0501AAA-R63/C
1	200, 230	7-1/2	120	4-20	ECN0511AAA-R63/C
	460	10	120	4-20	ECN0511AAA-R63/C
2	200, 230	10	120	9-45	ECN0521AAA-R63/D
	460	25	120	9-45	ECN0521AAA-R63/D

NEMA combination, non-reversing starters, non-fusible disconnect Type 1

NEMA size	Motor voltage	Maximum hp rating	Magnet coil voltage	SSOL range	Catalog number
00	200, 230	1-1/2	120	1-5	ECN16A1AAA-R63/B
	460	2	120	1-5	ECN16A1AAA-R63/B
0	200, 230	3	120	1-5	ECN1601AAA-R63/B
	460	5	120	1-5	ECN1601AAA-R63/B
	200, 230	3	120	4-20	ECN1601AAA-R63/C
	460	5	120	4-20	ECN1601AAA-R63/C
1	200, 230	7-1/2	120	4-20	ECN1611AAA-R63/C
	460	10	120	4-20	ECN1611AAA-R63/C
2	200, 230	10	120	9-45	ECN1621AAA-R63/D
	460	25	120	9-45	ECN1621AAA-R63/D

Starters

NEMA enclosures with CPT modifications

To order an enclosure with CPT:

1. Change ECN05 to ECN07 for non-combination units, and ECN16 to ECN18 for combination units.
2. Change the "A" in the 7th catalog string to the correct letter based on the below table:

Catalog string letter	Primary	Secondary
E	208/60	120/60
B	240/480–220/440 wired for 240 V	120/60–110/50
C	240/480–220/440 wired for 480 V	120/60–110/50

NEMA accessories—CPT and fuse kits

Description	Catalog number
100 VA CPT kit (208/277 V primary, 120 V secondary)	C341CE
100 VA CPT kit (240/480 V primary, 120 V secondary)	C341CC
Fuse clip kit for combination starter—30 A / 250 V	C351KC21
Fuse clip kit for combination starter—30 A / 600 V and 60 A / 250 V	C351KD22-61

NEMA accessories—cover control kits

Description	Catalog number		
	Non-combination Type 1, size 00–2	Non-combination Type 1, size 3–5	Combination Type 1 and all Type 3R, 12, 4X
STOP/START pushbuttons	C600M1	C400GK1	C400T1
STOP/START pushbuttons with red RUN light (85–264 Vac)	C600M101A	C400GK12	—
HAND/OFF/AUTO selector switch	C600M12	C400GK3	C400T12
HAND/OFF/AUTO selector switch with red RUN light (85–264 Vac)	C600M121A	C400GK32	—

Catalog numbering system—enclosed lighting contactors

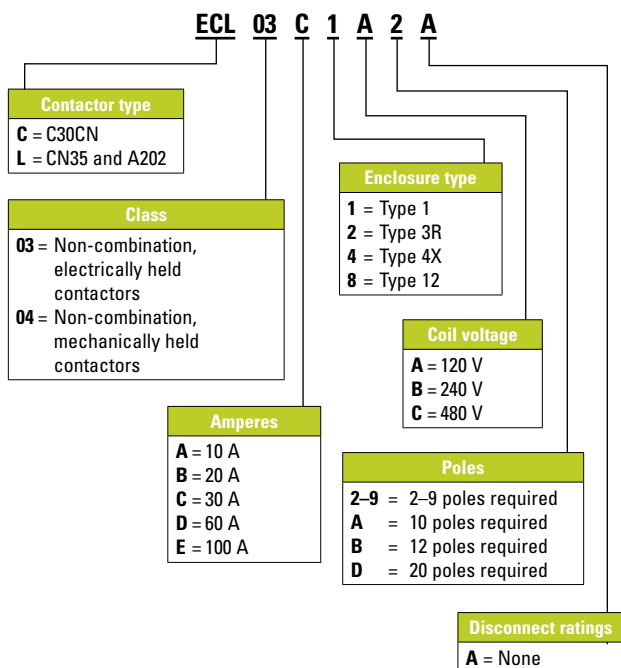

Lighting contactors

Lighting non-combination contactors, Type 1

Contactor type	Number of poles	Ampere rating	Coil voltage	Catalog number
C30CN, electrically held	2	30	120	ECC03C1A2A
C30CN, electrically held	4	30	120	ECC03C1A4A
C30CN, electrically held	6	30	120	ECC03C1A6A
CN35, electrically held	2	20	120	ECL03B1A2A
CN35, electrically held	4	20	120	ECL03B1A4A
CN35, electrically held	6	20	120	ECL03B1A6A

Questions to ask

Step

1

Q Do you need an assembled pushbutton station or loose components in clam-shell packaging?

A — Assembled pushbutton station
— Loose components in clam-shell package

Step

2

For pushbutton stations

Q What size of pushbutton station do you need?

A — 22 mm
— 30 mm

Q How many elements (operators) do you want?

A — 1
— 2
— 3

Step

3

For loose components

Q What type of operator do you need?

A — Emergency stop operator
— Momentary pushbutton
— Indicating light
— Illuminated pushbutton
— Selector switches

Pushbutton stations and pushbuttons

Pushbutton stations

30 mm pushbutton stations

Description	Catalog number
Single-element	
Emergency Off—break glass pushbutton station, NC	10250TGR
Man-Off-Auto selector switch pushbutton station, 2NO	10250T3524
Stop mushroom head pushbutton station, 1NC	10250T3519
Two-element	
Start-Stop pushbutton station, 1NO-2NC	10250T3525
Start-Stop rectangular pushbutton station, 1NO-1NC	10250H5200
Three-element	
Open-Close-Stop pushbutton station, 2NO-3NC	10250T3614
Up-Down-Stop rectangular pushbutton station, 2NO-1NC	10250H5301

22 mm pushbutton stations

Description	Catalog number
Single-element	
40 mm mushroom head push-pull emergency stop operator, NC	M22-C1-M1H
40 mm illuminated mushroom head push-pull emergency stop operator, 85–264 Vac, NO-NC	M22-C1-M2H
Two-element	
Flush pushbutton, Start-Stop, NO-NC	M22-C2-M2V
Flush pushbutton, Forward-Reverse, 2NO	M22-C2-M3V
Three-element	
Flush pushbutton, Open-Stop-Close, 2NO-1NC	M22-C3-M4V
Flush pushbutton, Forward-Stop-Reverse, 2NO-1NC	M22-C3-M5V
Flush pushbutton, Up-Stop-Down, 2NO-NC	M22-C3-M6V

Pushbutton components

Individually packaged 30 mm pushbuttons and operators NEMA 4, 4X, 12 13

Description	Catalog number
Emergency stop operator	
Red non-illuminated push-pull, 1NO-1NC, includes 2 legend plates: EMERG. STOP and STOP	10250T5B62-1-POP
Jumbo mushroom pushbutton, 1NO-1NC, button engraved EMERG. STOP (button is engraved—no legend plate provided)	10250T33-POP
Red mushroom pushbutton engraved EMERG. STOP, 1NO-1NC, includes 2 legend plates: EMERG. STOP and STOP	10250T32R-POP
Momentary pushbutton	
Black flush pushbutton, 1NO-1NC, includes 1 legend plate: START and JOG	10250T30B-POP
Red extended pushbutton, 1NO-1NC, includes 1 legend plate: STOP	10250T31R-POP
Indicating light	
Red indicating light transformer 120 Vac with two extra lenses (green and amber), 1NO-1NC, includes 2 legend plates: RUN and JOG	10250T34R-POP
Illuminated pushbutton	
Red illuminated pushbutton (120 Vac/Vdc), with 2 extra lenses (green and amber), 1NO-1NC, includes 1 legend plate: Power On	10250T411C21-1-POP
Selector switches	
Two-position selector switch, 1NO-1NC, includes 3 legend plates: Off/On, Hand/Auto and Run/Jog	10250T20KB-POP
Three-position selector switch, 2NO-2NC, includes 1 legend plate: Hand/Off/Auto	10250T22KB-POP
Three-position selector switch, 1NO-1NC, includes 1 legend plate: Hand/Off/Auto	10250T21KB-POP

Questions to ask

Step

1

Q What is the motor nameplate information?

- A**
- System (AC or DC) and voltage?
 - If AC, is the motor single-phase or three-phase?
 - What is the motor horsepower?

Step

2

Q What type of enclosure is needed?

- A**
- No enclosure (will be mounted in separate enclosure)
 - NEMA 1 enclosure

Step

3

Q Is overload protection required?

- A**
- No
 - Yes. If yes, what is the motor full load amperes (FLA)?

Step

4

Q What type of operator does the customer want?

- A**
- Button
 - Toggle

Manual starters

Manual starters

Manual motor switches without overload

Type	Pole config.	Maximum motor (hp)				Catalog number	
		120 V	240 V	480 V	230 V	Open	Enclosed
B230A	Two-pole	2	5	—	—	B230AN	B230AG
B230B	Two-pole	2	5	10	15	B230BND	B230BGD
	Three-pole	3	7.5	15	20	B330AND	B330AGD

Single-phase manual starters with overload protection— Type MS series starters ①

Pole config.	NEMA size	Maximum motor (hp)			Catalog number	
		AC voltage			Open	Enclosed ②
		120 Vac	240 Vac	277 Vac		
Single-pole	0	1	1	1	MST01	MST01SN1P
Two-pole	0	1	1	1	MST02	MST02SN1P

Pole config.	NEMA size	Maximum motor (hp)			Catalog number	
		DC voltage			Open	Enclosed ②
		120 Vdc	240 Vdc	32 Vdc		
Single-pole	0	¼	¼	¼	MST01	MST01SN1P
Two-pole	0	¼	¼	¼	MST02	MST02SN1P

① Use MSH heaters for MS series starters.

② With pilot light.

Single- and three-phase manual starters with overload protection— Type B100 ①

Pole config.	NEMA size	Maximum motor (hp)			Catalog number	
		AC voltage			Open	Enclosed ②
		120 Vac	208–240 Vac	480–600 Vac		
Two-pole (single-phase)	0	1	2	—	B100M0B	B100S0B
	1	2	3	—	B100M1B	B100S1B
Three-pole (three-phase)	0	2	3	5	B100M0C	B100S0C
	1	3	7½	10	B100M1C	B100S1C

Pole config.	NEMA size	Maximum motor (hp)		Catalog number	
		DC voltage		Open	Enclosed ②
		115 Vdc	230 Vdc		
Two-pole (single-phase)	0	1	1½	B100M0B	B100S0B
	1	1½	2	B100M1B	B100S1B
Three-pole (three-phase)	0	—	—	B100M0C	B100S0C
	1	—	—	B100M1C	B100S1C

① Use FH heaters for Type B100 starters.

② NEMA 1.

* At Eaton, we believe that power is a fundamental part of just about everything people do. Technology, transportation, energy and infrastructure—these are things the world relies on every day. That's why Eaton is dedicated to helping our customers find new ways to manage electrical, hydraulic and mechanical power more efficiently, safely and sustainably. To improve people's lives, the communities where we live and work, and the planet our future generations depend upon. Because that's what really matters. And we're here to make sure it works.

See more at [Eaton.com/whatmatters](https://www.eaton.com/whatmatters)

For more information, visit
[Eaton.com/powrstock](https://www.eaton.com/powrstock)

Eaton is a registered trademark.

All other trademarks are property of their respective owners.

Eaton
1000 Eaton Boulevard
Cleveland, OH 44122
United States
[Eaton.com](https://www.eaton.com)

© 2018 Eaton
All Rights Reserved
Printed in USA
Publication No. CA08307001E / Z20429
February 2018

EATON
Powering Business Worldwide