



CAT HP J-HOOK, PRE-GALVANIZED, 1" DIA

CATALOG NUMBER

CAT16HP



nVent CADDY Cat HP J-Hooks are the foundation of the nVent CADDY Cat HP System. The revamped nVent CADDY Cat HP J-Hook offers contractors three unique, UL-certified attachment methods out of the box—wall, ceiling, and threaded rod installations. This added functionality enables contractors to reduce SKU inventory while maintaining efficiency and continued progress on the jobsite with the most common structural attachment methods.

The modernized design of the nVent CADDY Cat HP J-Hook is engineered to provide optimal support and protection for today's rapidly evolving, high-performing low voltage cable. Contractors can feel confident utilizing the nVent CADDY Cat HP J-Hook due to its installation versatility, superior cable support and protection, and technical certifications.

CERTIFICATIONS



FEATURES

Versa-Mount Technology: Innovative attachment design provides multiple structural and installation methods for wall, ceiling, and threaded rod mounting applications

Ideal for unknown jobsite applications or attachment methods

Improved design allows for optimized inventory while reducing job site scheduling risks associated with multiple SKUs

Provides optimal support for high-performance data cable—including category cable, Power over Ethernet (PoE), and fiber optic

Industry-leading bend radius designed to protect high-performance data installations

Multiple color options aid in the identification and organization of the pathway application

Provides superior fill capacity and load rating

Compliant with UL® 2043 and suitable for use in air handling (plenum) spaces

Meets ISO®/IEC 14763-2, ANSI®/TIA 568 and ANSI®/TIA 569

Complies with EN 50174-2

PRODUCT ATTRIBUTES

Material: Steel

Finish: Pregalvanized

Diameter (\varnothing): 1"

Area: 1.07in²

Cable Capacity, Cat 5e: 20

Cable Capacity, Cat 6: 15

Cable Capacity, Cat 6A: 10

Height 1 (H1): 4.29

Height 2 (H2): 3.55

Static Load (F): 60lb

ADDITIONAL PRODUCT DETAILS

Non-continuous supports may not exceed spacing of 5' (1.5 m) per TIA 569-C.9.7 and EN 50174-2.

Cable capacity is calculated based on a 70% fill rate.

DIAGRAMS

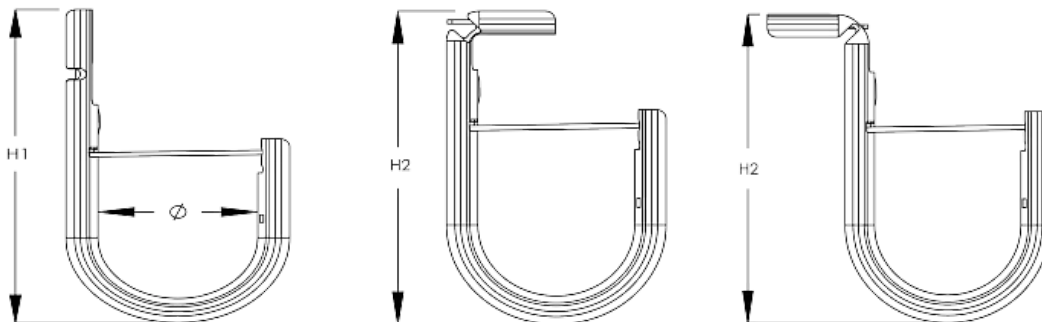

WARNING

nVent products shall be installed and used only as indicated in nVent's product instruction sheets and training materials. Instruction sheets are available at www.nvent.com and from your nVent customer service representative. Improper installation, misuse, misapplication or other failure to completely follow nVent's instructions and warnings may cause product malfunction, property damage, serious bodily injury and death and/or void your warranty.

North America

+1.800.753.9221

Option 1 – Customer Care

Option 2 – Technical Support

Europe

Netherlands:

+31 800-0200135

France:

+33 800 901 793

Europe

Germany:

800 1890272

Other Countries:

+31 13 5835404

APAC

Shanghai:

+ 86 21 2412 1618/19

Sydney:

+61 2 9751 8500



Our powerful portfolio of brands:
nVent.com CADDY ERICO HOFFMAN RAYCHEM SCHROFF
TRACER



CAT HP J-HOOK, PRE-GALVANIZED, 1" DIA

CATALOG NUMBER

CAT16HP



nVent CADDY Cat HP J-Hooks are the foundation of the nVent CADDY Cat HP System. The revamped nVent CADDY Cat HP J-Hook offers contractors three unique, UL-certified attachment methods out of the box—wall, ceiling, and threaded rod installations. This added functionality enables contractors to reduce SKU inventory while maintaining efficiency and continued progress on the jobsite with the most common structural attachment methods.

The modernized design of the nVent CADDY Cat HP J-Hook is engineered to provide optimal support and protection for today's rapidly evolving, high-performing low voltage cable. Contractors can feel confident utilizing the nVent CADDY Cat HP J-Hook due to its installation versatility, superior cable support and protection, and technical certifications.

CERTIFICATIONS



FEATURES

Versa-Mount Technology: Innovative attachment design provides multiple structural and installation methods for wall, ceiling, and threaded rod mounting applications

Ideal for unknown jobsite applications or attachment methods

Improved design allows for optimized inventory while reducing job site scheduling risks associated with multiple SKUs

Provides optimal support for high-performance data cable—including category cable, Power over Ethernet (PoE), and fiber optic

Industry-leading bend radius designed to protect high-performance data installations

Multiple color options aid in the identification and organization of the pathway application

Provides superior fill capacity and load rating

Compliant with UL® 2043 and suitable for use in air handling (plenum) spaces

Meets ISO®/IEC 14763-2, ANSI®/TIA 568 and ANSI®/TIA 569

Complies with EN 50174-2

PRODUCT ATTRIBUTES

Material: Steel

Finish: Pregalvanized

Diameter (\varnothing): 1"

Area: 1.07in²

Cable Capacity, Cat 5e: 20

Cable Capacity, Cat 6: 15

Cable Capacity, Cat 6A: 10

Height 1 (H1): 4.29

Height 2 (H2): 3.55

Static Load (F): 60lb

ADDITIONAL PRODUCT DETAILS

Non-continuous supports may not exceed spacing of 5' (1.5 m) per TIA 569-C.9.7 and EN 50174-2.

Cable capacity is calculated based on a 70% fill rate.

DIAGRAMS

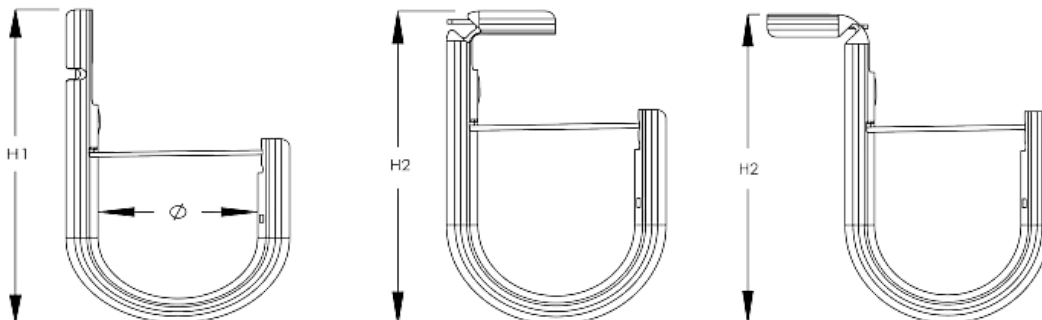

WARNING

nVent products shall be installed and used only as indicated in nVent's product instruction sheets and training materials. Instruction sheets are available at www.nvent.com and from your nVent customer service representative. Improper installation, misuse, misapplication or other failure to completely follow nVent's instructions and warnings may cause product malfunction, property damage, serious bodily injury and death and/or void your warranty.

North America

+1.800.753.9221

Option 1 – Customer Care

Option 2 – Technical Support

Europe

Netherlands:

+31 800-0200135

France:

+33 800 901 793

Europe

Germany:

800 1890272

Other Countries:

+31 13 5835404

APAC

Shanghai:

+ 86 21 2412 1618/19

Sydney:

+61 2 9751 8500



Our powerful portfolio of brands:
nVent.com CADDY ERICO HOFFMAN RAYCHEM SCHROFF
TRACER