

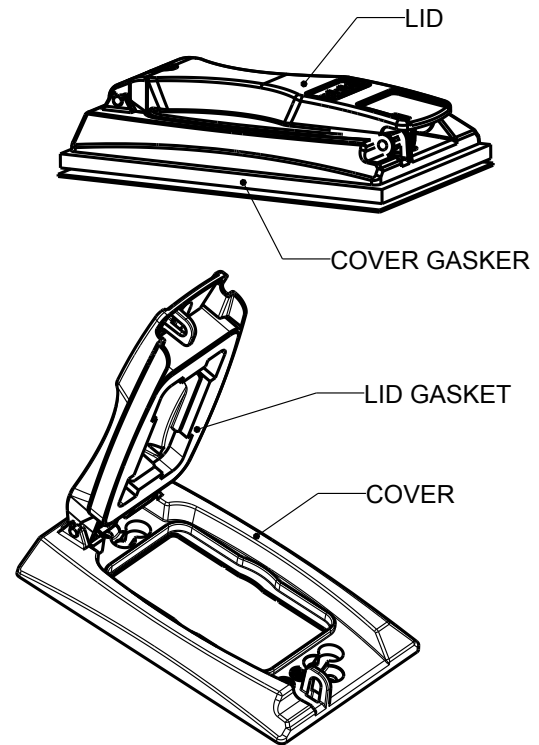

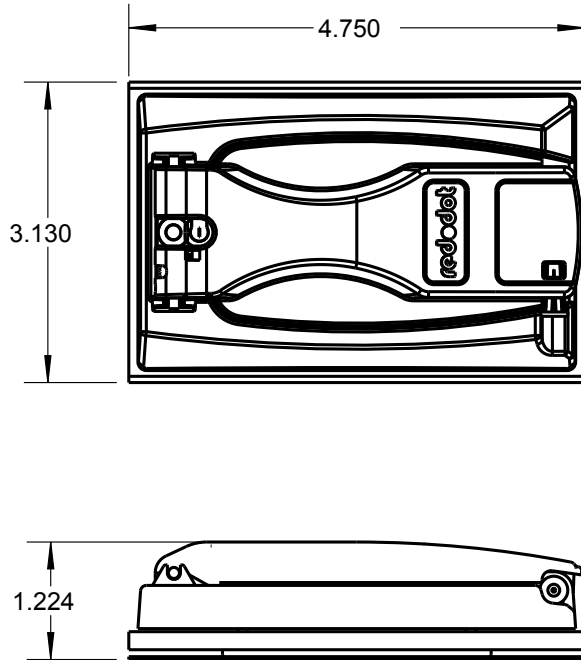

Red•Dot



NOTES:

1. COVER & LID: DIE CAST ZINC, POWDER COAT FINISH.
2. COVER & LID GASKET: CROSS-LINKED POLYETHYLENE FOAM.
3. MOUNTING HARDWARE, DUPLEX AND SWITCH ADAPTER PLATES PROVIDED.

CAT. NO.	DESCRIPTION			
CCU	SINGLE-GANG COVER (INSTALLS VERTICALLY OR HORIZONTALLY)-SILVER			
DCCU	D-PAK -SINGLE-GANG COVER, SILVER			
DCCU-BR	D-PAK -SINGLE-GANG COVER, BRONZE			
DCCU-WH	D-PAK -SINGLE-GANG COVER, WHITE			
GENERAL NOTES		 A Member of the ABB Group www.tnb.com		
1. ALL DIMENSIONS ARE FOR REFERENCE ONLY. 2. DIMENSIONS IN BRACKETS [] ARE IN METRIC UNITS.				
REVISIONS		DESCRIPTION: SINGLE-GANG UNIVERSAL FLIP-LID COVER		
0 SEE ERN (****) FOR APPROVAL SIGNATURES & RELEASE DATE. PROJECT NO: ****	ORIGINAL PROJECT NO / (ERN NO) 002V000686 / (2017563)	SHEET NO: 1 OF 1	REV. NO: 0	DRAWING NO: WSD-001717



Red-Dot

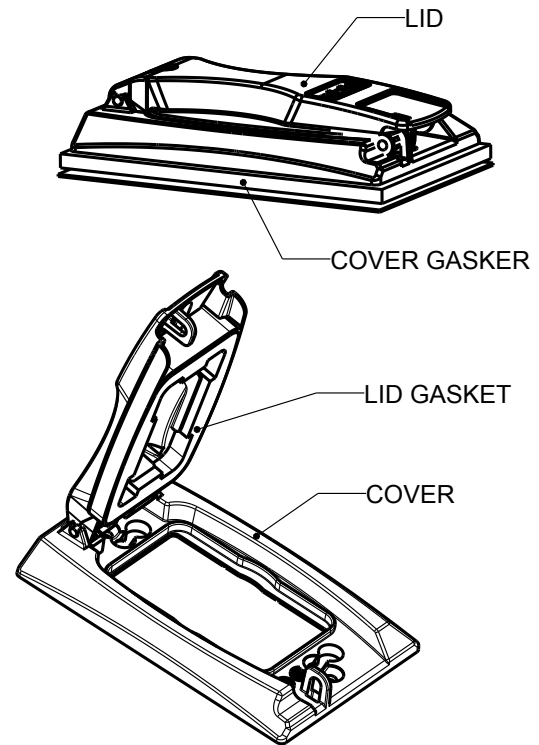
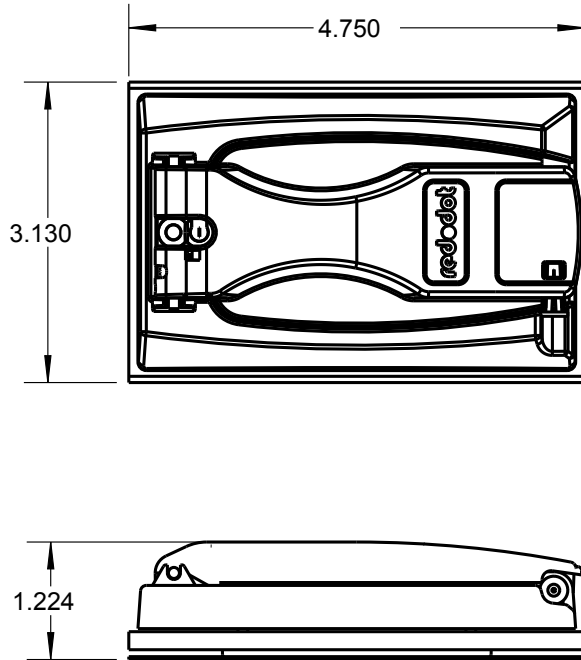

NOTES:

1. COVER & LID: DIE CAST ZINC, POWDER COAT FINISH.
2. COVER & LID GASKET: CROSS-LINKED POLYETHYLENE FOAM.
3. MOUNTING HARDWARE, DUPLEX AND SWITCH ADAPTER PLATES PROVIDED.

CAT. NO.	DESCRIPTION							
CCU	SINGLE-GANG COVER (INSTALLS VERTICALLY OR HORIZONTALLY)-SILVER							
DCCU	D-PAK -SINGLE-GANG COVER, SILVER							
DCCU-BR	D-PAK -SINGLE-GANG COVER, BRONZE							
DCCU-WH	D-PAK -SINGLE-GANG COVER, WHITE							
GENERAL NOTES		 A Member of the ABB Group www.tnb.com						
1. ALL DIMENSIONS ARE FOR REFERENCE ONLY. 2. DIMENSIONS IN BRACKETS [] ARE IN METRIC UNITS.					DESCRIPTION: SINGLE-GANG UNIVERSAL FLIP-LID COVER			
REVISIONS		<table border="1"> <tr> <td data-bbox="475 1902 857 1997">ORIGINAL PROJECT NO / (ERN NO) 002V000686 / (2017563)</td> <td data-bbox="857 1902 1000 1997">SHEET NO: 1 OF 1</td> <td data-bbox="1000 1902 1143 1997">REV. NO: 0</td> <td data-bbox="1143 1902 1531 1997">DRAWING NO: WSD-001717</td> </tr> </table>			ORIGINAL PROJECT NO / (ERN NO) 002V000686 / (2017563)	SHEET NO: 1 OF 1	REV. NO: 0	DRAWING NO: WSD-001717
ORIGINAL PROJECT NO / (ERN NO) 002V000686 / (2017563)	SHEET NO: 1 OF 1	REV. NO: 0	DRAWING NO: WSD-001717					
0	SEE ERN (****) FOR APPROVAL SIGNATURES & RELEASE DATE. PROJECT NO: ****							