

SCALE 1.000

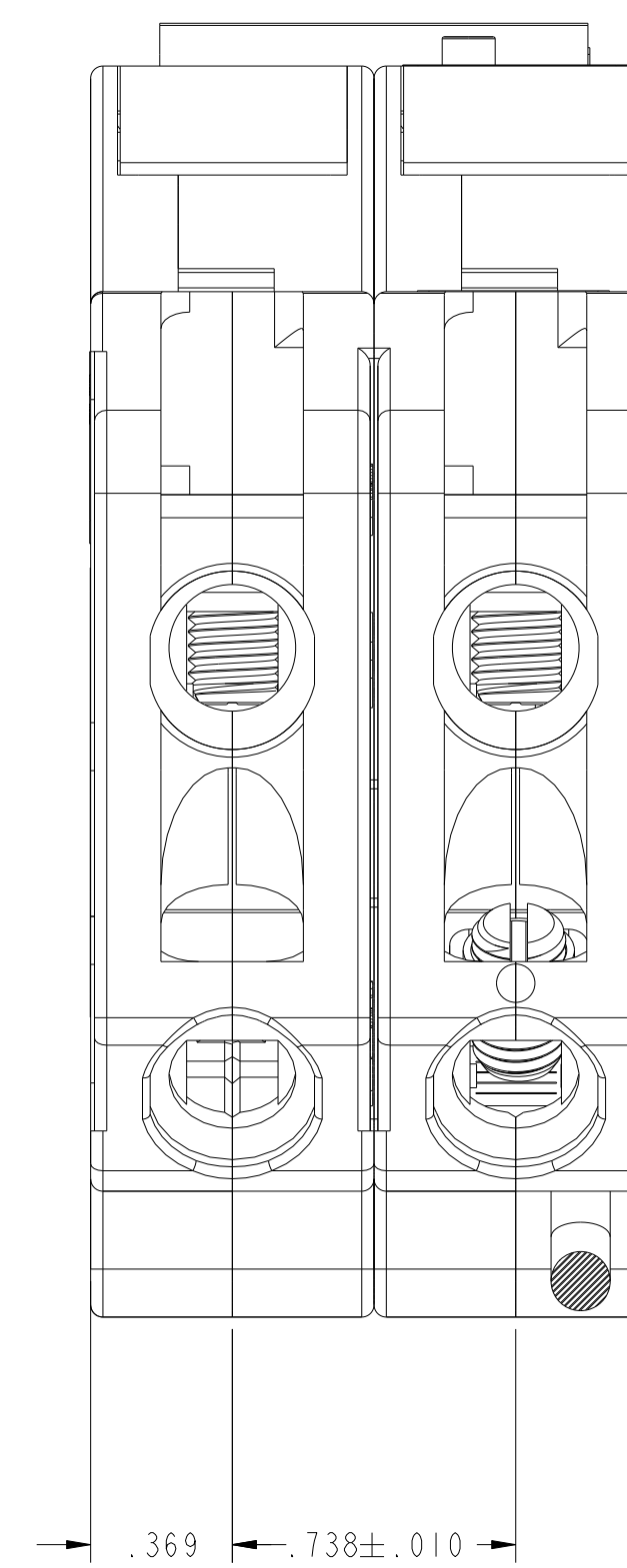
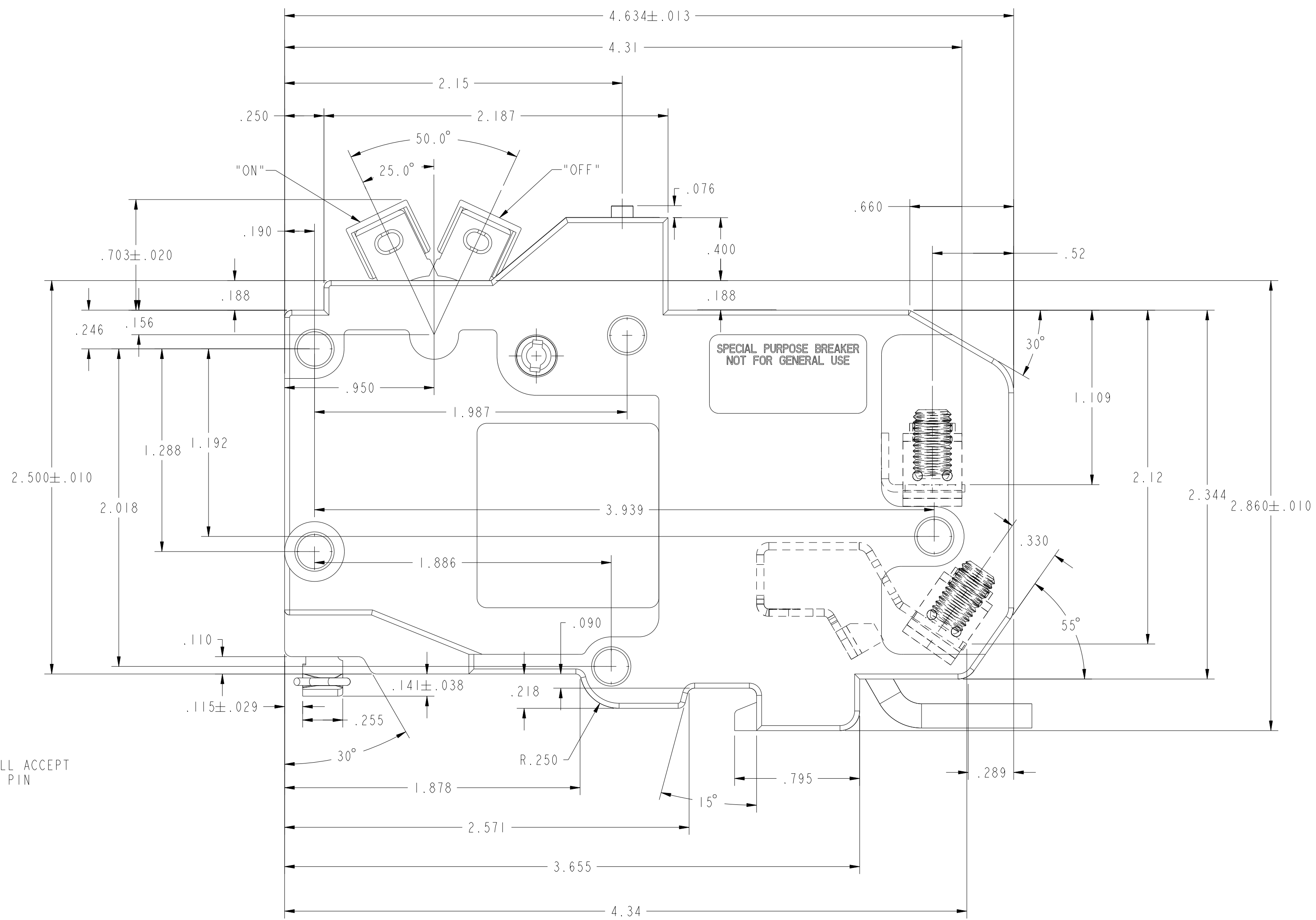
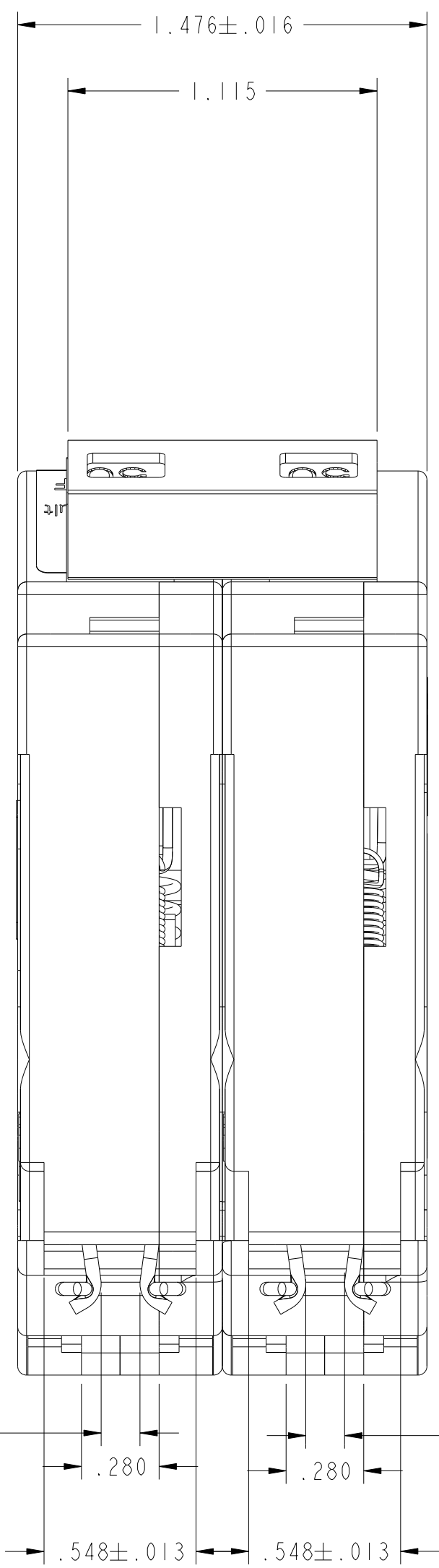

OPENING WILL ACCEPT A 3/16 DIA PIN

OPENING WILL ACCEPT A 3/16 DIA PIN

UNLESS OTHERWISE SPECIFIED DIMENSIONS IN INCHES X.X ±0.1 X.XX ±0.01 X.XXX ±0.001 X" ±0 X.X" ±0.5	DRAFTER/DESIGNER L. PORTUONDO	DATE (YYYYMMDD) 2015/07/02	EATON CORPORATION - CONFIDENTIAL AND PROPRIETARY NOTICE TO PERSONS RECEIVING THIS DOCUMENT AND/OR TECHNICAL INFORMATION THIS DOCUMENT, INCLUDING THE DRAWING AND INFORMATION CONTAINED THEREON, IS CONFIDENTIAL AND IS THE EXCLUSIVE PROPERTY OF EATON CORPORATION, AND IS LOANED TO YOU AND SUBJECT TO RECEIPT BY EATON AT ANY TIME. BY TAKING POSSESSION OF THIS DOCUMENT, THE RECIPIENT ACKNOWLEDGES AND AGREES THAT THIS DOCUMENT CANNOT BE USED IN ANY MANNER ADVISED BY THE INTERESTS OF EATON AND THAT NO PORTION OF THIS DOCUMENT MAY BE COPIED OR OTHERWISE REPRODUCED WITHOUT THE PRIOR WRITTEN CONSENT OF EATON. IN THE CASE OF CONFLICTING CONTRACTUAL PROVISIONS, THIS NOTICE SHALL GOVERN THE STATUS OF THIS DOCUMENT. © 2015 Eaton Corporation. All Rights Reserved.
	ENGINEERING APPROVED G. DE JESUS	MANUFACTURING M. GONZALEZ	
	REVISION DESCRIPTION NEW DRAWING	ECO # ECO-082761	
	DRAWING IN ACCORDANCE WITH ASME Y14.3M-1994		
(L) (X) (II) SYMBOLS PER 488-1143			TITLE <b>GROUND FAULT CIRCUIT INTERRUPTER</b> 3/4" 2-POLE GFT 15A - 60A OUTLINE DRAWING
ENG/MFG REFERENCE PRODUCT CODE: BCD9			SIZE D
			CHANGE RESPONSIBILITY RWDD_MCB_ENGINEERING <b>EATON</b>
			CLASS CODE NA
			SCALE 2.000 = 1.000
			SHEET 001

