

Twist-Lock® Devices
 50A, 3 Phase 250V AC, 3 Pole, 4 Wire
 Grounding
 Insulgrip® Plug

HUBBELL

Features

- Super tough nylon housing offers better impact qualities
- Stainless steel shroud protects contacts and prevents mismating
- Heavy duty two-piece external cord clamp provides maximum strain relief
- Box terminal with hex socket threaded slug, permits high clamping pressure on conductors without damaging strands
- Thermoplastic polyester interior provides heat resistance and impact strength

Ordering Information

Description	Cord Diameter	UPC	Catalog Number
Nylon cover, thermoplastic polyester interior	.830"-1.250" (21.08-31.75)	783585829128	CS8365C

Listings

Listed to UL 498
 Certified to CSA C22.2 No.42

Specifications

Housing	Nylon
Blade Holder	Polyester
Blades	Brass
Shell	Stainless Steel
Terminal Screws	Stainless steel
Cord Grip	Polyester

Performance

Electrical

Current Interrupting Certified for current interrupting at full rated current
 Dielectric Voltage Withstands 2,000V minimum

Mechanical

Terminal Accommodation #10 AWG - #6 AWG stranded copper wire only

Environmental

Flammability HB or better
 Operating Temperatures Maximum continuous 75°C; minimum -40°C (w/o impact)

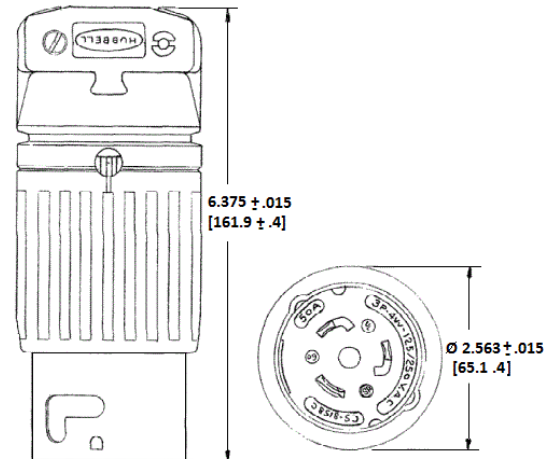

Accessories

Connector	CS8364C
Single Receptacle	CS8369
Weatherproof Boot	HBL7716C

Resources

Customer Use Drawing
 eCatalog

Dimensions in Inches (mm)

Hubbell Wiring Device-Kellems • Hubbell Incorporated (Delaware) • 40 Waterview Drive • Shelton, CT 06484

Phone (800) 288-6000 • Fax (800) 255-1031 • Specifications subject to change without notice.



Twist-Lock® Devices
 50A, 3 Phase 250V AC, 3 Pole, 4 Wire
 Grounding
 Insulgrip® Plug

HUBBELL

Features

- Super tough nylon housing offers better impact qualities
- Stainless steel shroud protects contacts and prevents mismatching
- Heavy duty two-piece external cord clamp provides maximum strain relief
- Box terminal with hex socket threaded slug, permits high clamping pressure on conductors without damaging strands
- Thermoplastic polyester interior provides heat resistance and impact strength

Ordering Information

Description	Cord Diameter	UPC	Catalog Number
Nylon cover, thermoplastic polyester interior	.830"-1.250" (21.08-31.75)	783585829128	CS8365C

Listings

Listed to UL 498
 Certified to CSA C22.2 No.42

Specifications

Housing	Nylon
Blade Holder	Polyester
Blades	Brass
Shell	Stainless Steel
Terminal Screws	Stainless steel
Cord Grip	Polyester

Performance

Electrical

Current Interrupting Certified for current interrupting at full rated current
 Dielectric Voltage Withstands 2,000V minimum

Mechanical

Terminal Accommodation #10 AWG - #6 AWG stranded copper wire only

Environmental

Flammability HB or better
 Operating Temperatures Maximum continuous 75°C; minimum -40°C (w/o impact)

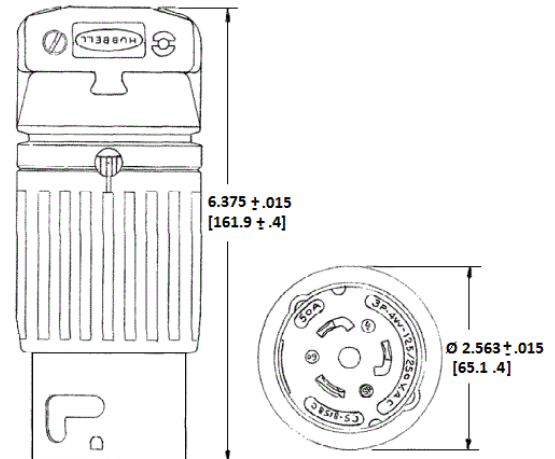

Accessories

Connector	CS8364C
Single Receptacle	CS8369
Weatherproof Boot	HBL7716C

Resources

Customer Use Drawing
 eCatalog

Dimensions in Inches (mm)

Hubbell Wiring Device-Kellems • Hubbell Incorporated (Delaware) • 40 Waterview Drive • Shelton, CT 06484

Phone (800) 288-6000 • Fax (800) 255-1031 • Specifications subject to change without notice.

