

RadioRA 2 Hybrid Keypads

RadioRA 2 Hybrid Keypads function as a dimmer and keypad combined into a single device. They are useful where lights need to be dimmed and controlled by a keypad in the same location. Hybrid Keypads are great for retro-fit applications because they eliminate the need to install two separate devices.

RadioRA 2 Hybrid Keypads have an available neutral wire terminal that allows them to be installed in either two-wire or neutral wire installations. Connecting the neutral wire to a Hybrid Keypad allows a lower minimum load to be used. Also, normal keypad operation will be available even if the attached load is not installed or if the lamp is burned out. If a neutral wire is available in the wallbox it should be connected to the silver terminal on the Hybrid Keypad. If a neutral wire is not available and not desired, then the silver terminal should be tightened without any wires connected to it. Hybrid Keypads can be installed in either single location or multi-location (with Remote Dimmer) installations.

RadioRA 2 Hybrid Keypads can be controlled as part of a lighting control system and incorporate advanced features such as fade on/fade off and rapid full on.

RadioRA 2 Hybrid Keypads feature large, easy-to-use buttons, plus a unique backlit engraving option that makes them readable any time of the day or night. The Hybrid Keypad buttons are rounded, allowing engraving to be displayed at an upward angle, increasing readability. RadioRA 2 Hybrid Keypads include a Front Accessible Service Switch (FASS™) for safe lamp replacement.

Use only Lutron® Designer (Claro® or Satin Colors®) wallplates. The mechanical design of the Hybrid Keypad is NOT compatible with non-Lutron wallplates. Wallplates are sold separately. Lutron Claro and Satin Colors wallplates snap on with no visible means of attachment. Replacement Kits are available in a variety of colors and with custom engraving to identify clearly each button's function.

Model Numbers

Incandescent/Halogen/Magnetic Low-Voltage	
RRD-H6BRL-XX*	450 W/450 VA Two-wire or Neutral Wire Dimmer and Keypad 120 V~
RKD-H6BRL-XX*-E	Engraved Replacement Kit
RD-RD-XX*	Remote Dimmer for multi-location installations

*Available in 27 colors. Please see page 6 for color selections.



Hybrid Keypad



Remote Dimmer

RadioRA 2 Hybrid Keypads

Specifications

Model Numbers	RRD-H6BRL-XX RKD-H6BRL-XX-E (Engraved Replacement Kit); RD-RD-XX (Remote Dimmer)
Power	120 V \sim 50/60 Hz
Typical Power Consumption	0.75 W Test conditions: load is off, all backlights on medium intensity, two LEDs on (two presets active), keypad powered at 120 V \sim .
Regulatory Approvals	UL, CSA, NOM, FCC, IC, COFETEL
Environment	Ambient operating temperature: 32 °F to 104 °F (0 °C to 40 °C), 0% to 90% humidity, non-condensing. Indoor use only.
Communications	Hybrid Keypads communicate with the system through Radio Frequency (RF) and must be located within 30 ft (9 m) of a repeater. Remote dimmers are not required to be within a specific range of a repeater.
ESD protection	Tested to withstand electrostatic discharge without damage or memory loss, in accordance with IEC 61000-4-2.
Surge Protection	Tested to withstand surge voltages without damage or loss of operation, in accordance with IEEE C62.41-1991 Recommended Practice on Surge Voltages in Low-Voltage AC Power Circuits.
Power Failure	Power failure memory: should power be interrupted, the control will return to its previous state when power is restored.
Mounting	Requires a U.S. wallbox. 3 ½ in (89 mm) deep recommended, 2 ¼ in (57 mm) deep minimum. If mounting one control above another, leave at least 4 ½ in (114 mm) vertical space between them.
Wiring	Uses conventional 3-way and 4-way wiring.
Warranty	1 Year Limited Warranty. http://www.lutron.com/resiinfo

Design Features

- Keypad buttons are programmable to select scene or room preset levels or positions.
- At the press of a keypad button, lights fade ON or OFF to desired levels and shades/draperies open or close to desired positions.
- Adjustable backlight intensity.
- Prepaid engraving included. Redeemable for one engraved Replacement Kit.
- Internal dimmer is assigned to top button by default. Tap top button to toggle load ON/OFF.
- Internal dimmer can be assigned to any button on the Hybrid Keypad and can be programmed to be controlled by any Keypad.
- Can be installed in 2-wire or neutral wire applications.
- Can be installed in either single location or multi-location (with Remote Dimmer) installations.

RadioRA 2 Hybrid Keypads

Dimensions

All dimensions are shown as $\frac{\text{in}}{\text{(mm)}}$

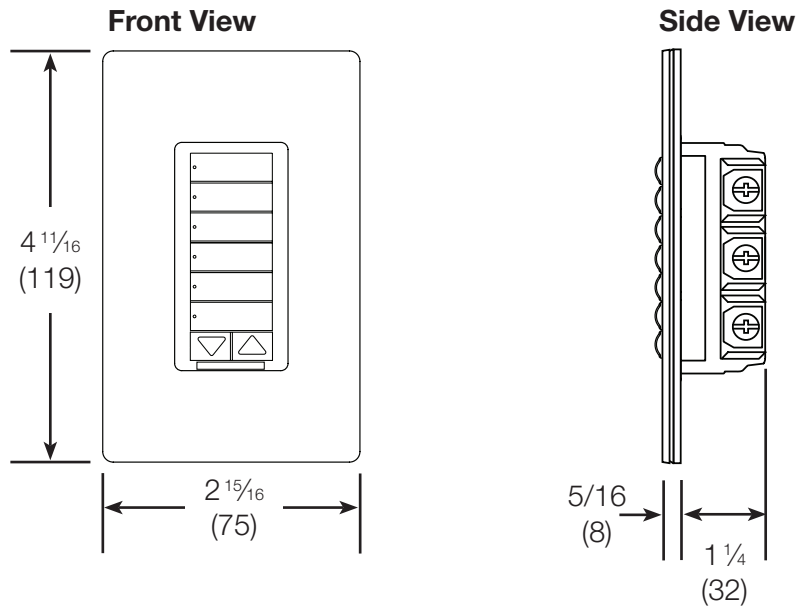

Mounting and Parts Identification

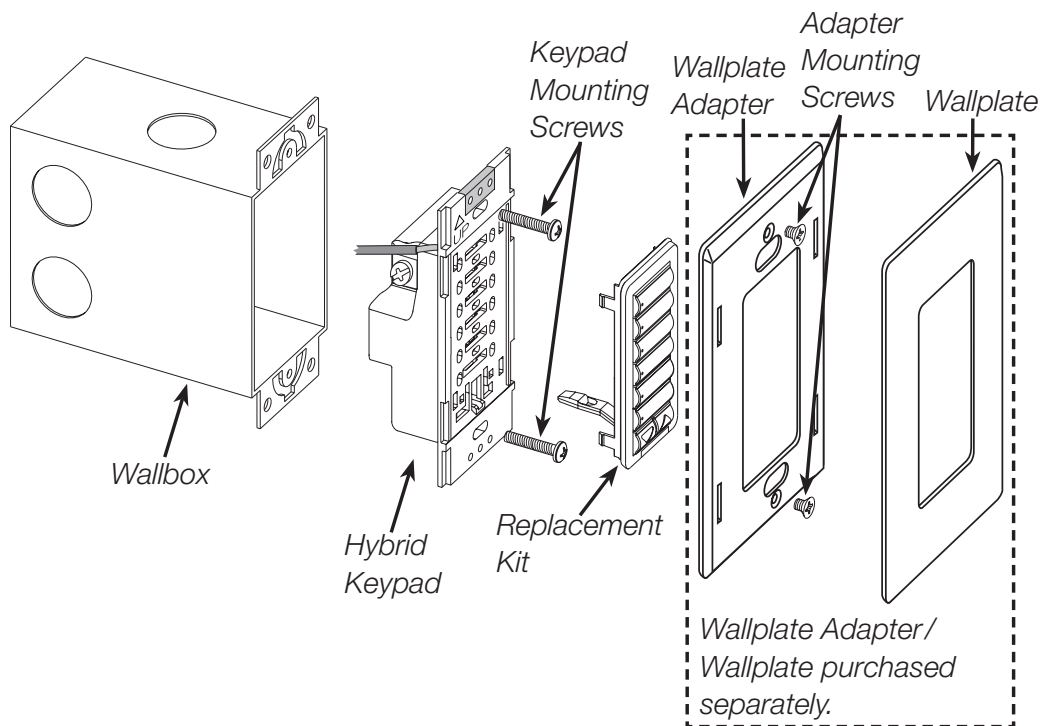

RadioRA 2 Hybrid Keypads

Load type and capacity

Load Type	Minimum Load		Not Ganged	End of Gang	Middle of Gang
	With Neutral	Without Neutral			
Incandescent ¹	15 W	50 W	450 W	350 W	250 W
MLV ²	15 W/VA	50 W/VA	350 W/450 VA	250 W/350 VA	200 W/250 VA

1 Load Type: Hybrid Keypads are designed for use with permanently installed incandescent, magnetic low-voltage, or tungsten halogen only. To reduce the risk of overheating and possible damage to other equipment, do not install Hybrid Keypads to control receptacles or motor-operated appliances.

2 Low-Voltage Applications: Use Hybrid Keypads with magnetic (core and coil) low-voltage transformers only. Not for use with electronic (solid-state) low-voltage transformers. Operation of a low-voltage circuit with lamps inoperative or removed may result in transformer overheating and premature failure. Lutron strongly recommends the following:

- Do not operate low-voltage circuits without operative lamps in place.
- Replace burned-out lamps as quickly as possible.
- Use transformers that incorporate thermal protection or fused transformer primary windings to prevent transformer failure due to overcurrent.

Compatible Power Boosters and Load Interfaces

Some local controls can be used to control power boosters or load interfaces. Up to three power boosters or load interfaces can be used with one control. See table below for a list of compatible power boosters and load interfaces.

Control	Phase Adaptive Power Modules (PHPM-PA-120-WH & PHPM-PA-DV-WH)	3-wire Fluorescent Power Modules (PHPM-3F-120-WH & PHPM-3F-DV-WH)	Switched Power Module (PHPM-SW-DV-WH)	0-10 V Interface and Switching Module (GRX-TVI)
RRD-H6BRL	✓	✓	✓	✓

Operation

Hybrid Keypad

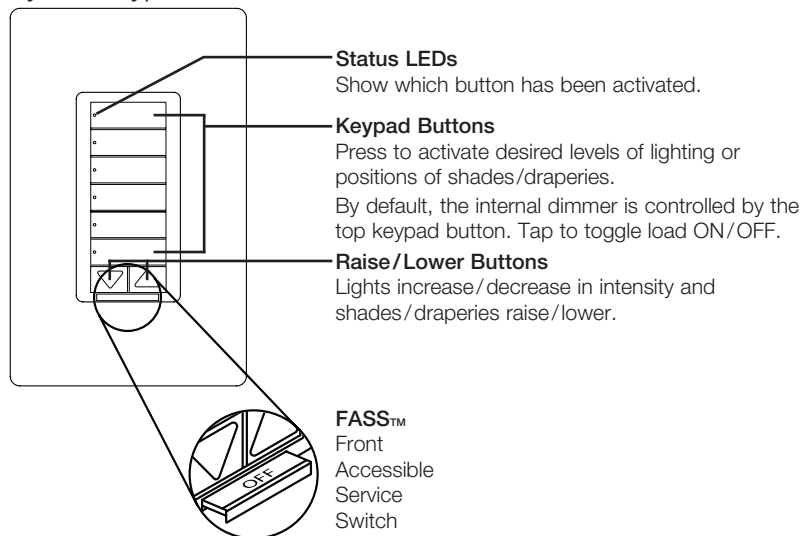

Remote Dimmer

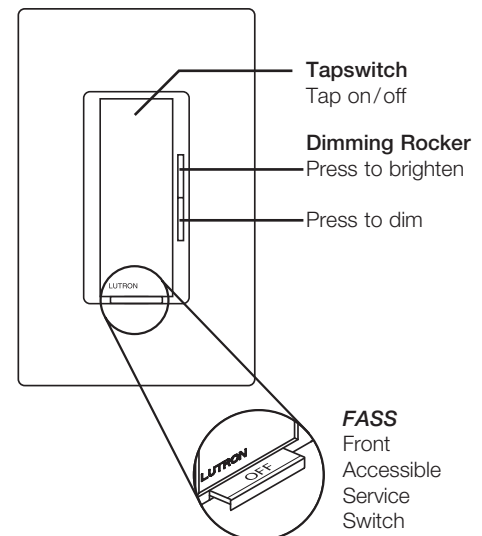

IMPORTANT NOTICE:

FASS - Front Accessible Service Switch

To replace bulbs, remove power by pulling the *FASS* out fully on all controlling devices. After replacing bulbs, push every *FASS* back in fully to restore power to the controls.

RadioRA 2 Hybrid Keypads

Wiring Diagrams

Single Location Installation with Neutral¹

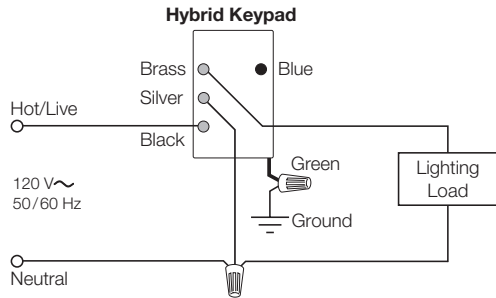

Single Location Installation without Neutral^{1,2}

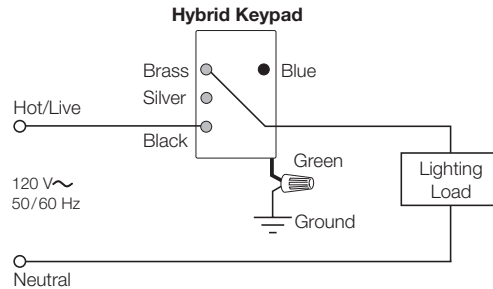

Multi-Location Installation with Neutral^{3,4}

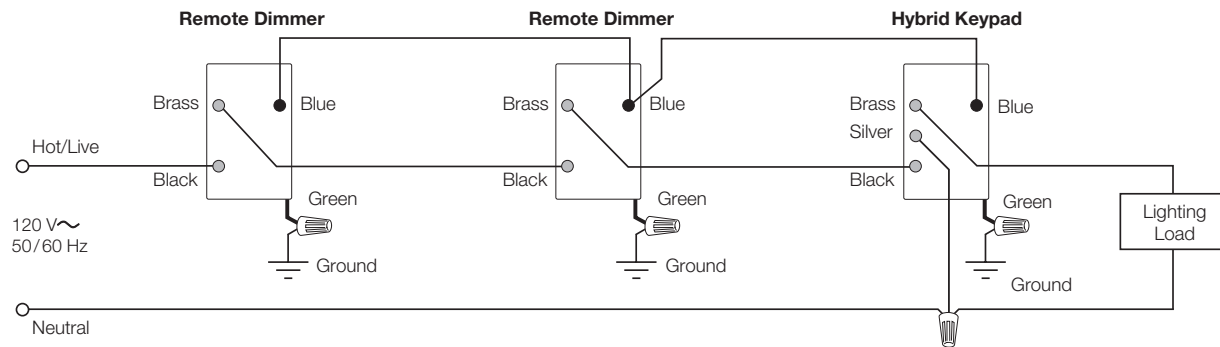

Multi-Location Installation without Neutral^{2,3}

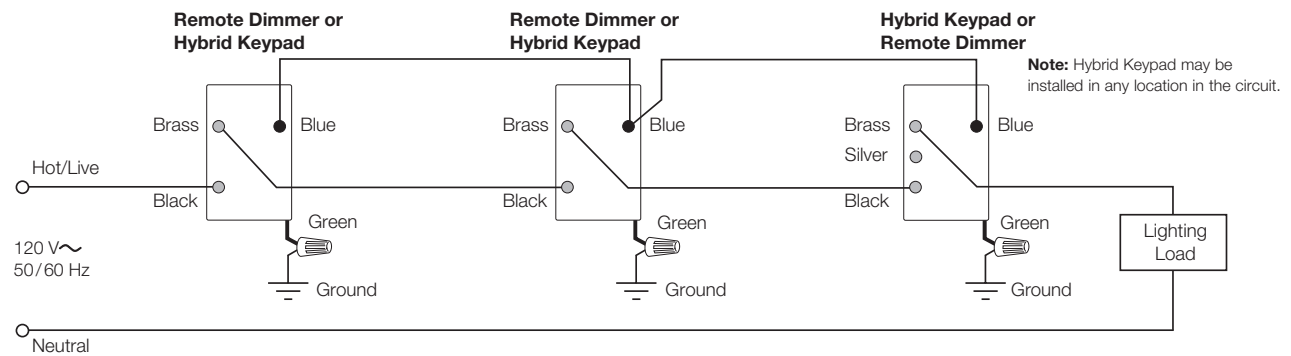

¹ When using controls in single location installations, tighten the blue terminal without any wires attached. DO NOT connect the blue terminal to any other wiring or to ground.

² In installations without a neutral wire connection, tighten the silver terminal without any wires attached. DO NOT connect the silver terminal to any other wiring or to ground.

³ Up to 9 Remote Dimmers may be connected to the Hybrid Keypad. Total blue terminal wire length may be up to 250 ft (76 m).

⁴ Neutral wire Hybrid Keypads must be connected on the load side of a multi-location installation.

RadioRA 2 Hybrid Keypads

Colors and Finishes

Gloss Finishes

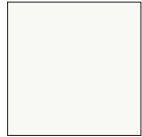

White
WH



Ivory
IV

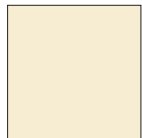

Almond
AL



Light
Almond
LA



Gray
GR



Brown
BR



Black
BL

Satin Finishes



Hot
HT

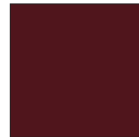

Merlot
MR



Plum
PL



Turquoise
TQ



Taupe
TP



Eggshell
ES

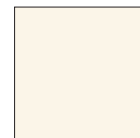

Biscuit
BI



Snow
SW



Palladium
PD



Midnight
MN



Sienna
SI



Terracotta
TC



Greenbriar
GB



Bluestone
BG

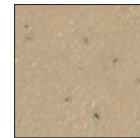

Mocha
Stone
MS



Goldstone
GS



Desert Stone
DS

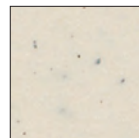

Stone
ST

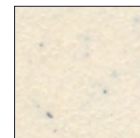

Limestone
LS

- Due to printing limitations, colors and finishes shown cannot be guaranteed to perfectly match actual product colors.
- Color chip keychains are available for more precise color matching:
Gloss Finishes- DG-CK-1
Satin Finishes - SC-CK-1

Metal Finish (wallplate only)



Stainless
Steel SS

When using Stainless Steel wallplates, it is recommended to order the controls in Black (BL) or Midnight (MN).