





Shown actual size: Rotary dimmer and 1-gang Fassada wallplate in White (WH).



### Product family features

- The original electronic dimmer—first patented in 1959
- Easy-turn knob adjusts light to your favorite level
- eco-dim® model available
- 100% factory tested
- Coordinating Fassada® and Stainless Steel wallplates only available separately
- Custom engraving available for wallplates, see pg. 155

### Control types

-  Single-pole (one location)
-  3-way or 4-way (two or more locations)

### Direct load type compatibility

-  Incandescent/halogen lighting
-  Ceiling fans

Lighting load interfaces are not compatible with this family.

### Available finishes

Use **BOLD** color code in model number (Example: D-600P-**IV**)

Gloss finishes\*



**WH**  
White



**IV**  
Ivory

### Dimmers and fan controls

#### Dimmer with rotate on/off knob



- Rotate on/off; rotate to adjust light level

#### Dimmers with push on/off knob and locator light



- Push on/off; rotate to adjust light level
- Includes locator light

#### Dimmers with push on/off knob



- Push on/off; rotate to adjust light level
- **eco-dim**® model guarantees at least 15% energy savings compared to a standard switch

#### Fan controls with rotate on/off knob



- Rotate on/off; rotate to adjust fan speed
- Quiet 3-speed available for use with one paddle fan
- Quiet 3-speed designed to prevent motor hum
- Fully variable available for use with multiple paddle or exhaust fans

\*Coordinating wallplates only available separately. For wallplate information, see pg. 166.

Connections overview

Load connections\*

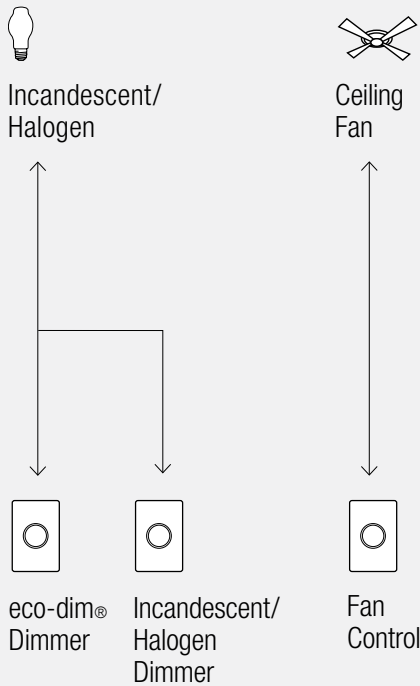

Control types (for 2 or more locations)  
Dim from one location, switch from the others

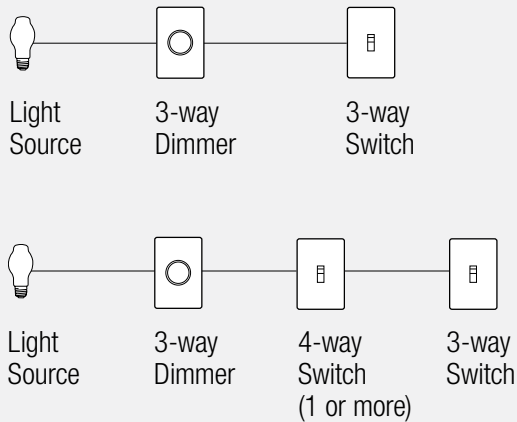

**CC<sup>3</sup>**: Gloss White (WH) and Ivory (IV), see pg. 135  
(Wallplates not included, order separately, see pg. 168)

\*For illustration purposes only. Consult model number pages for specific voltage and capacity information.

Dimmer, fan control and replacement knob model numbers

Incandescent/halogen dimmers

Dimmers with push on/off knob

Single-pole 120V 600W	D-600P- <b>CC<sup>3</sup></b>
3-way 120V 600W	D-603P- <b>CC<sup>3</sup></b>

Dimmers with push on/off knob and locator light

Single-pole 120V 600W	DNG-600P- <b>CC<sup>3</sup></b>
3-way 120V 600W	DNG-603P- <b>CC<sup>3</sup></b>

Dimmer with rotate on/off knob

Single-pole 120V 600W	D-600R- <b>CC<sup>3</sup></b>
--------------------------	-------------------------------

eco-dim® dimmer with push on/off knob

3-way/single-pole 120V 600W	D-603PG- <b>CC<sup>3</sup></b>
--------------------------------	--------------------------------

eco-dim model guarantees at least 15% energy savings compared to a standard switch.

Fan controls

Fan controls with rotate on/off knob—fully variable

Single-pole fan control factory set minimum speed 120V 5A	FS-5F- <b>CC<sup>3</sup></b>
Single-pole fan control user adjustable minimum speed 120V 5A	FS-5E- <b>CC<sup>3</sup></b>

Fan control with rotate on/off knob—quiet 3-speed

Single-pole 120V 1.5A	FSQ-2F- <b>CC<sup>3</sup></b>
--------------------------	-------------------------------

Knobs

Standard knob	RK- <b>CC<sup>3</sup></b>
3-speed fan control knob, White	280-324-01
3-speed fan control knob, Ivory	280-324-06

Accessories

Wallplates



Shown actual size:  
2-gang Fassade® wallplate in White (WH).  
For more information about Traditional wallplates, see pg. 166.

Coordinated electrical devices



Tamper resistant GFCI receptacle



Customizable 6-port frame



Cable jack

For more information about coordinated Designer electrical devices, see pg. 163.



Shown actual size:  
Abella dimmers in a  
2-gang Fassada  
wallplate in White (WH).

### Product family features

- Can be used in conjunction with the following dimmer(s) and switch(es): Abella®, Ceano®, Ariadni®, Glyder® and Rotary
- All Lutron wallplates are screwless, seamless and have no visible hardware; the front plate securely snaps into the alignment adapter plate
- Traditional wallplates can be paired with designer accessories to complete the look of any room
- Customize your traditional wallplate with engraving, contact customer service to get started at 1.888.LUTRON1

### Ganging and derating

- Traditional wallplates use standard ganging
- Requires fins to be removed from dimmers for proper spacing (“Fins Broken” ganging), see pg. 170
- May require derating (i.e., reduction of dimmer capacity due to fin removal), see Derating Tables, pg. 172

**Available finishes**

Use **BOLD** color code in model number (Example: FG-1-**AL**)

Gloss finishes



**WH**  
White



**LA**  
Light Almond



**AL**  
Almond



**IV**  
Ivory



**BL**  
Black

Metal finishes



**SS**  
Stainless Steel\*

\*Stainless Steel finish wallplates include black plastic trim/adaptor, visible from side. Match with separate Black (BL) controls.

**Wallplates for Abella®, Ceana®, Ariadni®, Glyder® and Rotary**



1-gang  
Stainless Steel\*  
W: 2.86 in (73mm); H: 4.60 in (117 mm);  
D: .23 in (5.8 mm)

FG-1-**CC**<sup>3</sup>  
FW-1-SS



3-gang  
Stainless Steel\*  
W: 6.48 in (165 mm); H: 4.60 in (117 mm);  
D: .23 in (5.8 mm)

FG-3-**CC**<sup>3</sup>  
FW-3-SS



2-gang  
Stainless Steel\*  
W: 4.67 in (119 mm); H: 4.60 in (117 mm);  
D: .23 in (5.8 mm)

FG-2-**CC**<sup>3</sup>  
FW-2-SS

**Combination opening**



Rotate the wallplate for small/large or large/small opening applications.

2-gang (1 traditional,  
1 designer opening)  
Stainless Steel\*  
W: 4.67 in (119 mm); H: 4.60 in (117 mm);  
D: .23 in (5.8 mm)

FG-2-TD-**CC**<sup>3</sup>  
FW-2-TD-SS

Multiple devices with line and low-voltage can be mounted behind a common wallplate using a standard barrier backbox, see Application Note #213 (Combining Low-Voltage and Line Voltage Wiring Devices in a Multi-Gang Box) at [www.lutron.com/applicationnotes](http://www.lutron.com/applicationnotes).

Controls must have heat-sink fins broken for multi-gang installations. Removing this metal reduces the amount of heat that the control can dissipate, thus reducing the wattage capacity of the control. Please derate dimmers and switches as required.

Multi-gang dimmer installations may require derating, see pg. 170.

Controls must have heat-sink fins broken for multi-gang installations. Multi-gang dimmer installations may require derating, see pg. 170.

\*Stainless Steel wallplates include black plastic trim/adaptor, visible from side. Match with separate Black (BL) controls.

**CC**<sup>3</sup>: Gloss color codes, see pg. 167

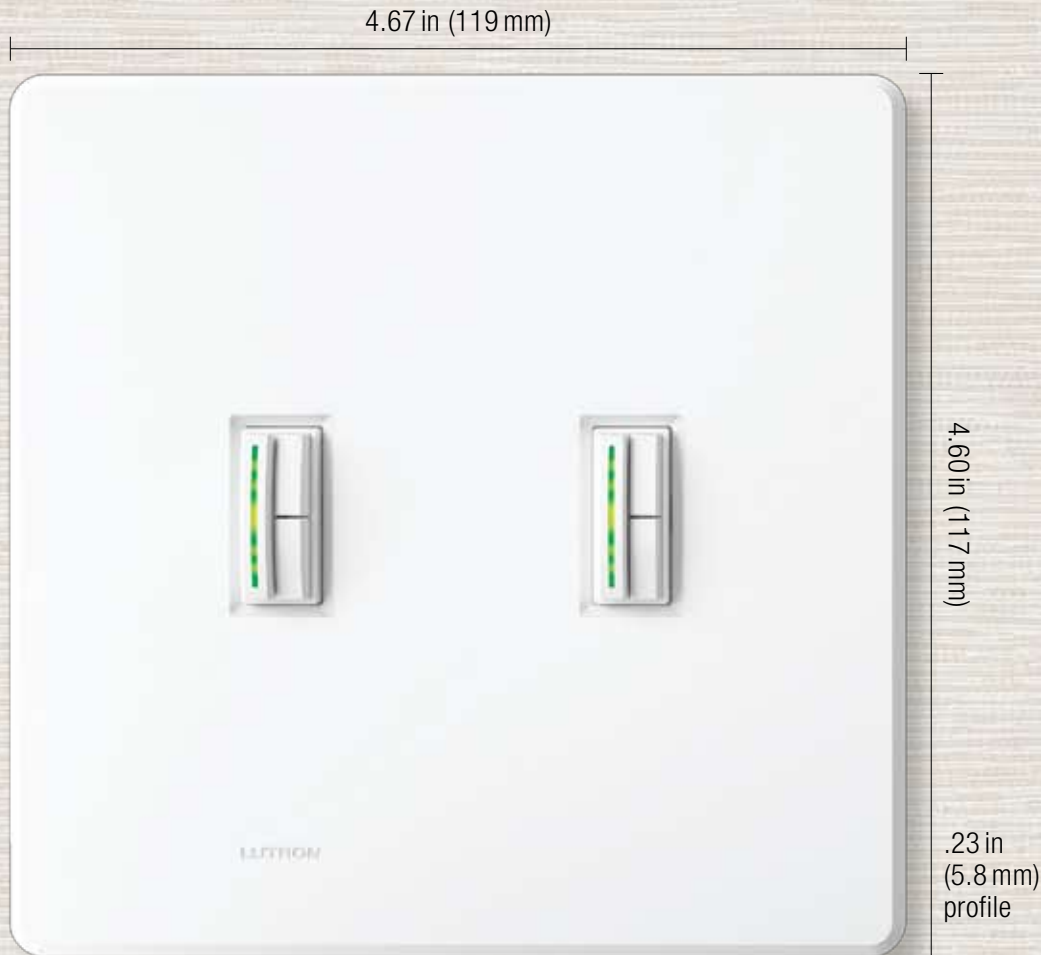

Shown actual size:  
Abella dimmers in a  
2-gang Fassada  
wallplate in White (WH).

### Product family features

- Can be used in conjunction with the following dimmer(s) and switch(es): Abella®, Ceano®, Ariadni®, Glyder® and Rotary
- All Lutron wallplates are screwless, seamless and have no visible hardware; the front plate securely snaps into the alignment adapter plate
- Traditional wallplates can be paired with designer accessories to complete the look of any room
- Customize your traditional wallplate with engraving, contact customer service to get started at 1.888.LUTRON1

### Ganging and derating

- Traditional wallplates use standard ganging
- Requires fins to be removed from dimmers for proper spacing (“Fins Broken” ganging), see pg. 170
- May require derating (i.e., reduction of dimmer capacity due to fin removal), see Derating Tables, pg. 172



**Available finishes**

Use **BOLD** color code in model number (Example: FG-1-**AL**)

Gloss finishes



**WH**  
White



**LA**  
Light Almond



**AL**  
Almond



**IV**  
Ivory



**BL**  
Black

Metal finishes



**SS**  
Stainless Steel\*

\*Stainless Steel finish wallplates include black plastic trim/adaptor, visible from side. Match with separate Black (BL) controls.

**Wallplates for Abella®, Ceana®, Ariadni®, Glyder® and Rotary**



1-gang  
Stainless Steel\*  
W: 2.86 in (73mm); H: 4.60 in (117 mm);  
D: .23 in (5.8 mm)

FG-1-**CC**<sup>3</sup>  
FW-1-SS



3-gang  
Stainless Steel\*  
W: 6.48 in (165 mm); H: 4.60 in (117 mm);  
D: .23 in (5.8 mm)

FG-3-**CC**<sup>3</sup>  
FW-3-SS



2-gang  
Stainless Steel\*  
W: 4.67 in (119 mm); H: 4.60 in (117 mm);  
D: .23 in (5.8 mm)

FG-2-**CC**<sup>3</sup>  
FW-2-SS

**Combination opening**



Rotate the wallplate for small/large or large/small opening applications.

2-gang (1 traditional,  
1 designer opening)  
Stainless Steel\*  
W: 4.67 in (119 mm); H: 4.60 in (117 mm);  
D: .23 in (5.8 mm)

FG-2-TD-**CC**<sup>3</sup>  
FW-2-TD-SS

Multiple devices with line and low-voltage can be mounted behind a common wallplate using a standard barrier backbox, see Application Note #213 (Combining Low-Voltage and Line Voltage Wiring Devices in a Multi-Gang Box) at [www.lutron.com/applicationnotes](http://www.lutron.com/applicationnotes).

Controls must have heat-sink fins broken for multi-gang installations. Removing this metal reduces the amount of heat that the control can dissipate, thus reducing the wattage capacity of the control. Please derate dimmers and switches as required.

Multi-gang dimmer installations may require derating, see pg. 170.

Controls must have heat-sink fins broken for multi-gang installations. Multi-gang dimmer installations may require derating, see pg. 170.

\*Stainless Steel wallplates include black plastic trim/adaptor, visible from side. Match with separate Black (BL) controls.

**CC**<sup>3</sup>: Gloss color codes, see pg. 167

## How to understand ganging and derating

### Standard ganging

Ganging is the side-by-side mounting of two or more dimmers or accessory devices under a multi-gang wallplate.

Standard multi-gang installation:

- Uses standard multi-gang electrical backboxes
- Uses standard multi-gang wallplates
- Requires fins to be removed from dimmers for proper spacing (“Fins Broken” ganging)
- May require derating (i.e., reduction of dimmer capacity due to fin removal), see Derating Tables, pgs. 172–173

### Custom ganging for Architectural style controls

For Architectural style dimmers and switches, it is possible to retain the maximum capacity of dimmers in multi-gang applications via custom architectural multi-gang:

- May require customized, wider-than-standard wallplates
- May require wider-than-standard electrical backboxes
- Allows full capacity (“No Fins Broken”) ganging
- Required for Nova® dimmers and for larger width (high capacity) architectural controls
- Visit [www.lutron.com/customganging](http://www.lutron.com/customganging) for additional information

## Standard ganging for dimmers, switches and accessories

### New Architectural



pg. 148

### Architectural



pg. 152

### Designer

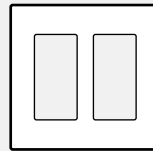

pg. 160

### Traditional

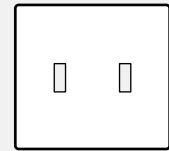

pg. 166



Vierti®

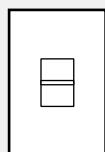

Vareo®  
Nova T☆®

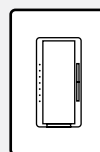

Maestro®  
Maestro IR®  
Maestro Wireless®  
Spacer System®  
Diva®  
Lyneo® Lx  
Skylark®  
Skylark Contour™

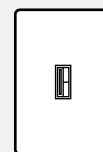

Abella®  
Ceana®  
Ariadni®  
Glyder®  
Rotary

Derating Table 1  
pg. 172

Derating Table 2  
pg. 173

Derating Table 1  
pg. 172

Derating Table 1  
pg. 172

**Standard ganging and fins broken derating examples:**

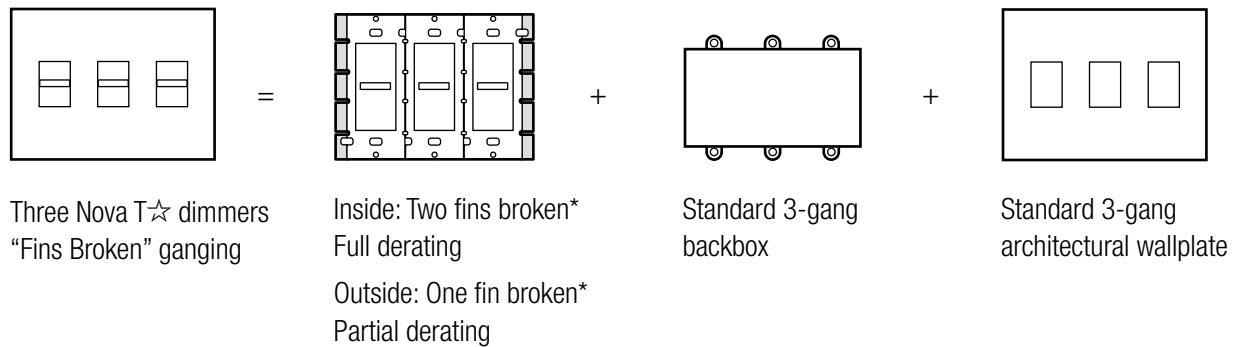
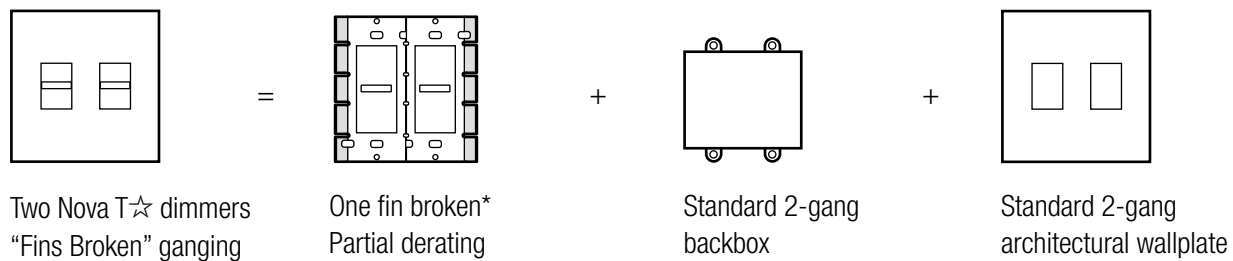
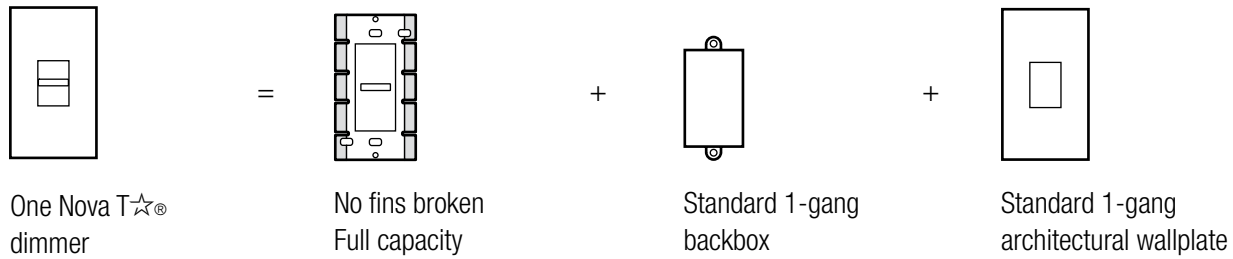

**Custom Architectural ganging example:**

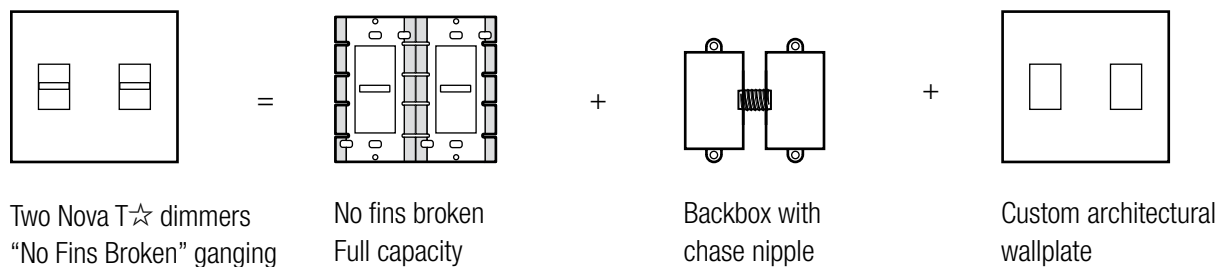

For further information on ganging and derating, visit [www.lutron.com/multigang](http://www.lutron.com/multigang).

\*The fins are scored and designed to be removed easily.

**Derating Table 1**

**New Architectural** | Verti®

**Designer** | Maestro®, Maestro IR®, Maestro Wireless®, Spacer System®, Diva®, Lyneo® Lx, Skylark Contour™, Skylark®

**Traditional** | Abella®, Ceano®, Ariadni®, Glyder®, Rotary



**No fins broken**



**1 fin broken**



**2 fins broken**

	No fins broken	1 fin broken	2 fins broken
<b>Incandescent</b>			
Dimmers	600W	500W	400W
	1000W	800W	650W
Dual dimmers	300W	250W	200W
	300W	250W	200W
<b>Magnetic low-voltage</b>			
Dimmers	600VA/450W	500VA/400W	400VA/300W
	1000VA/800W	800VA/650W	650VA/500W
<b>Electronic low-voltage</b>			
Dimmers	300W	250W	200W
	500W	450W	400W
	600W	500W	400W
<b>Fluorescent</b>			
<b>Hi-lume®/Hi-lume® Compact SE/Eco-10®/EcoSystem®</b>			
Verti	60 ballasts/6A	50 ballasts/5A	35 ballasts/3.5A
Maestro/Spacer System	20 ballasts/6A	20 ballasts/5A	20 ballasts/3.5A
Diva, Skylark, Lyneo Lx and Ariadni	no derating	no derating	no derating
Tu-Wire®: Spacer System, Diva, Skylark	5A	4A	3.3A
<b>Fan controls</b>			
Quiet 7-speed	1.0A/300W	1.0A/300W	1.0A/300W
Quiet 3-speed	1.5A	1.5A	1.5A
Fully variable	5A	4A	3A
<b>Fan/light controls</b>			
Quiet 7-speed	1.0A/300W	1.0A/300W	1.0A/300W
Quiet 3-speed	1.5A/300W	1.5A/300W	1.5A/300W
	1.5A/360W	1.5A/360W	1.5A/360W
Fully variable	2.5A/300W	2.1A/250W	1.7A/200W
<b>Electronic switches</b>			
Verti	6A/3A	5A/3A	3.5A/3A
Maestro (light/fan)	8A/3A	6.5A/3A	5A/3A
Abella (light/fan)	6A/3A	5A/3A	3.5A/3A

**Derating Table 2**

**Architectural** | Vareo®, Nova T☆®



**No fins broken**



**1 fin broken**



**2 fins broken**

	No fins broken	1 fin broken	2 fins broken
<b>Incandescent</b>			
Dimmers	600W	500W	300W
	1000W	900W	700W
	1500W	1250W	1000W
	1950W	–	–
<b>Magnetic low-voltage</b>			
Dimmers	600 VA/450 W	500 VA/400 W	300 VA/250 W
	1000 VA/800 W	900 VA/750 W	700 VA/500 W
	1500 VA/1200 W	1250 VA/1000 W	1000 VA/800 W
<b>Electronic low-voltage</b>			
Dimmers	300W	300W	250W
	600W	500W	400W
<b>Fluorescent</b>			
<b>Hi-lume®/Hi-lume® Compact SE/Eco-10®/EcoSystem®</b>			
Vareo	20 ballasts /8 A	20 ballasts /6 A	20 ballasts /4.5 A
Nova T☆	6 A	no derating	no derating
	8 A	no derating	no derating
	16 A	no derating	no derating
0-10VDC control <sup>1</sup>	30mA ballasts	no derating	no derating
Tu-Wire®	5 A	4 A	3.3 A
<b>Fan controls</b>			
Quiet 3-speed	1.5 A	no derating	no derating
Fully variable	6 A	4.2 A	2.5 A
Fully variable	12 A	10 A	8.3 A
<b>Electronic tapswitches<sup>2</sup></b>			
VETS-1000-	1000W	800W	650W
VETS-1000-SL-	1000W	900W	700W
VETN-1000-	1000 VA	700 VA	550 VA

For further information on ganging Nova®, visit [www.lutron.com/customganging](http://www.lutron.com/customganging).

<sup>1</sup>PowerPack required for line voltage switching.

<sup>2</sup>VETS-R-Auxiliary electronic tapswitches do not require derating.

## Rotary

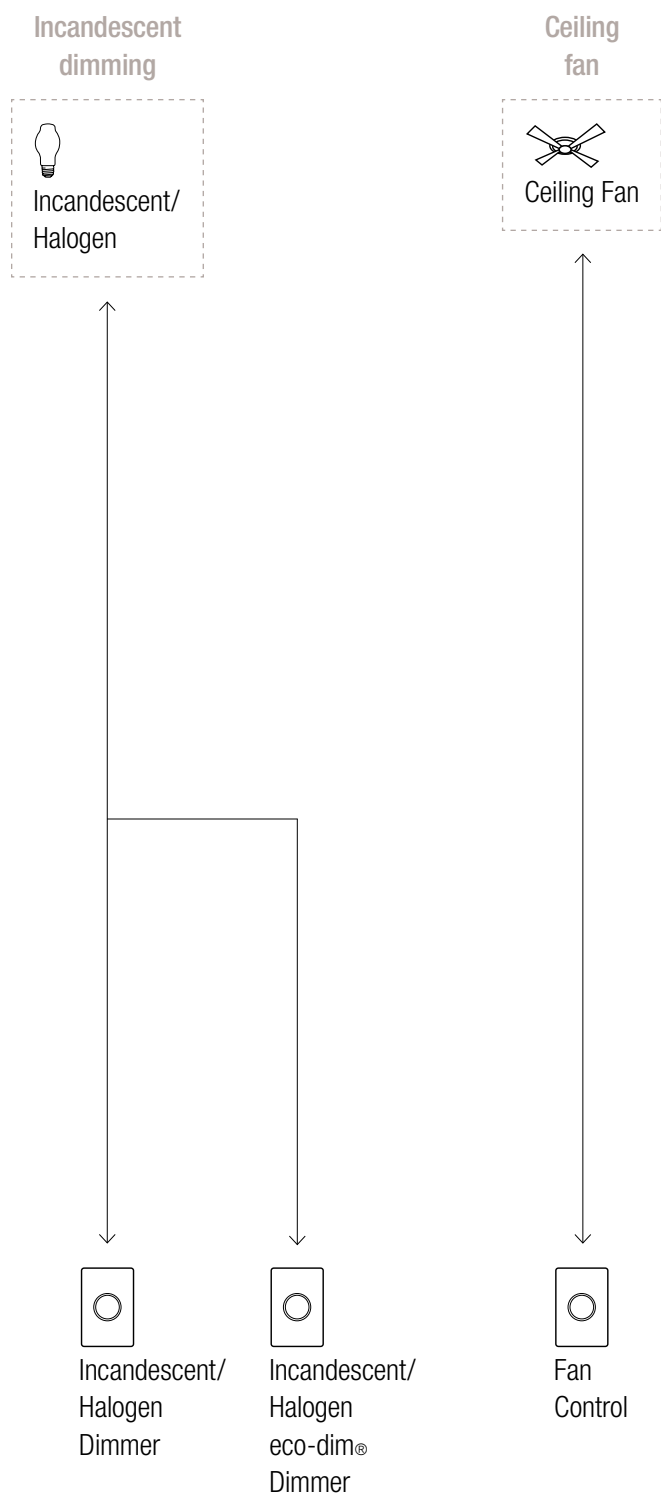

**For illustration purposes only.** Consult model number pages for specific voltage and capacity information.





Shown actual size: Rotary dimmer and 1-gang Fassada wallplate in White (WH).



### Product family features

- The original electronic dimmer—first patented in 1959
- Easy-turn knob adjusts light to your favorite level
- eco-dim® model available
- 100% factory tested
- Coordinating Fassada® and Stainless Steel wallplates only available separately
- Custom engraving available for wallplates, see pg. 155

### Control types

-  Single-pole (one location)
-  3-way or 4-way (two or more locations)

### Direct load type compatibility

-  Incandescent/halogen lighting
-  Ceiling fans

Lighting load interfaces are not compatible with this family.



### Available finishes

Use **BOLD** color code in model number (Example: D-600P-**IV**)

Gloss finishes\*



**WH**  
White



**IV**  
Ivory

### Dimmers and fan controls

#### Dimmer with rotate on/off knob



- Rotate on/off; rotate to adjust light level

#### Dimmers with push on/off knob and locator light



- Push on/off; rotate to adjust light level
- Includes locator light

#### Dimmers with push on/off knob



- Push on/off; rotate to adjust light level
- **eco-dim**® model guarantees at least 15% energy savings compared to a standard switch

#### Fan controls with rotate on/off knob



- Rotate on/off; rotate to adjust fan speed
- Quiet 3-speed available for use with one paddle fan
- Quiet 3-speed designed to prevent motor hum
- Fully variable available for use with multiple paddle or exhaust fans

\*Coordinating wallplates only available separately. For wallplate information, see pg. 166.

Connections overview

Load connections\*

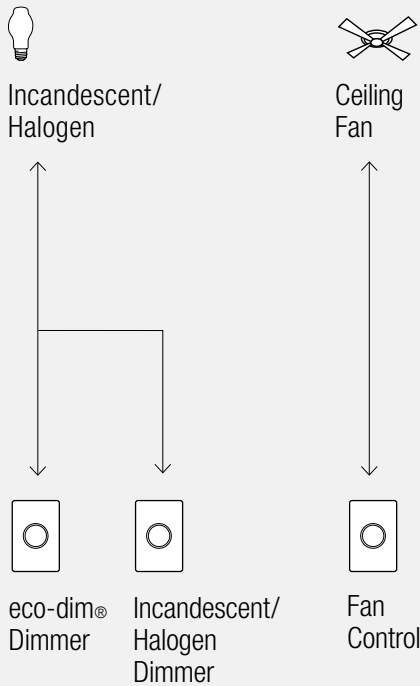

Control types (for 2 or more locations)  
Dim from one location, switch from the others

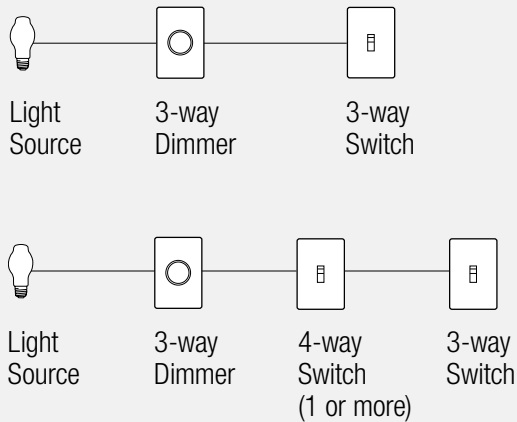

**CC<sup>3</sup>**: Gloss White (WH) and Ivory (IV), see pg. 135  
(Wallplates not included, order separately, see pg. 168)

\*For illustration purposes only. Consult model number pages for specific voltage and capacity information.

Dimmer, fan control and replacement knob model numbers

Incandescent/halogen dimmers

Dimmers with push on/off knob

Single-pole 120V 600W	D-600P- <b>CC<sup>3</sup></b>
3-way 120V 600W	D-603P- <b>CC<sup>3</sup></b>

Dimmers with push on/off knob and locator light

Single-pole 120V 600W	DNG-600P- <b>CC<sup>3</sup></b>
3-way 120V 600W	DNG-603P- <b>CC<sup>3</sup></b>

Dimmer with rotate on/off knob

Single-pole 120V 600W	D-600R- <b>CC<sup>3</sup></b>
--------------------------	-------------------------------

eco-dim® dimmer with push on/off knob

3-way/single-pole 120V 600W	D-603PG- <b>CC<sup>3</sup></b>
--------------------------------	--------------------------------

eco-dim model guarantees at least 15% energy savings compared to a standard switch.

Fan controls

Fan controls with rotate on/off knob—fully variable

Single-pole fan control factory set minimum speed 120V 5A	FS-5F- <b>CC<sup>3</sup></b>
Single-pole fan control user adjustable minimum speed 120V 5A	FS-5E- <b>CC<sup>3</sup></b>

Fan control with rotate on/off knob—quiet 3-speed

Single-pole 120V 1.5A	FSQ-2F- <b>CC<sup>3</sup></b>
--------------------------	-------------------------------

Knobs

Standard knob	RK- <b>CC<sup>3</sup></b>
3-speed fan control knob, White	280-324-01
3-speed fan control knob, Ivory	280-324-06

Accessories

Wallplates



Shown actual size:  
2-gang Fassade® wallplate in White (WH).  
For more information about Traditional wallplates, see pg. 166.

Coordinated electrical devices



Tamper resistant GFCI receptacle



Customizable 6-port frame



Cable jack

For more information about coordinated Designer electrical devices, see pg. 163.

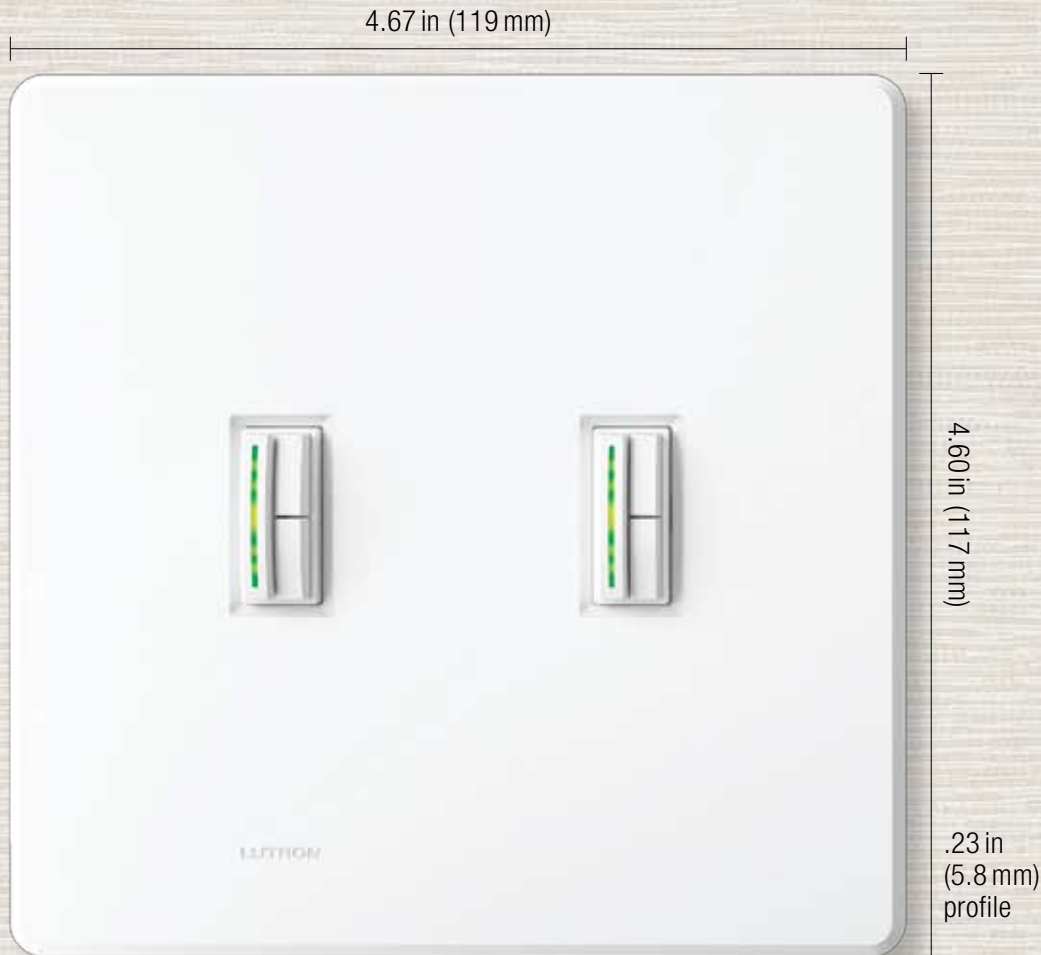

### Product family features

- Can be used in conjunction with the following dimmer(s) and switch(es): Abella®, Ceano®, Ariadni®, Glyder® and Rotary
- All Lutron wallplates are screwless, seamless and have no visible hardware; the front plate securely snaps into the alignment adapter plate
- Traditional wallplates can be paired with designer accessories to complete the look of any room
- Customize your traditional wallplate with engraving, contact customer service to get started at 1.888.LUTRON1

### Ganging and derating

- Traditional wallplates use standard ganging
- Requires fins to be removed from dimmers for proper spacing (“Fins Broken” ganging), see pg. 170
- May require derating (i.e., reduction of dimmer capacity due to fin removal), see Derating Tables, pg. 172

**Available finishes**

Use **BOLD** color code in model number (Example: FG-1-**AL**)

Gloss finishes



**WH**  
White



**LA**  
Light Almond



**AL**  
Almond



**IV**  
Ivory



**BL**  
Black

Metal finishes



**SS**  
Stainless Steel\*

\*Stainless Steel finish wallplates include black plastic trim/adaptor, visible from side. Match with separate Black (BL) controls.

**Wallplates for Abella®, Ceana®, Ariadni®, Glyder® and Rotary**



1-gang  
Stainless Steel\*  
W: 2.86 in (73mm); H: 4.60 in (117 mm);  
D: .23 in (5.8 mm)

FG-1-**CC**<sup>3</sup>  
FW-1-SS



3-gang  
Stainless Steel\*  
W: 6.48 in (165 mm); H: 4.60 in (117 mm);  
D: .23 in (5.8 mm)

FG-3-**CC**<sup>3</sup>  
FW-3-SS



2-gang  
Stainless Steel\*  
W: 4.67 in (119 mm); H: 4.60 in (117 mm);  
D: .23 in (5.8 mm)

FG-2-**CC**<sup>3</sup>  
FW-2-SS

**Combination opening**



Rotate the wallplate for small/large or large/small opening applications.

2-gang (1 traditional,  
1 designer opening)  
Stainless Steel\*  
W: 4.67 in (119 mm); H: 4.60 in (117 mm);  
D: .23 in (5.8 mm)

FG-2-TD-**CC**<sup>3</sup>  
FW-2-TD-SS

Multiple devices with line and low-voltage can be mounted behind a common wallplate using a standard barrier backbox, see Application Note #213 (Combining Low-Voltage and Line Voltage Wiring Devices in a Multi-Gang Box) at [www.lutron.com/applicationnotes](http://www.lutron.com/applicationnotes).

Controls must have heat-sink fins broken for multi-gang installations. Removing this metal reduces the amount of heat that the control can dissipate, thus reducing the wattage capacity of the control. Please derate dimmers and switches as required.

Multi-gang dimmer installations may require derating, see pg. 170.

Controls must have heat-sink fins broken for multi-gang installations. Multi-gang dimmer installations may require derating, see pg. 170.

\*Stainless Steel wallplates include black plastic trim/adaptor, visible from side. Match with separate Black (BL) controls.

**CC**<sup>3</sup>: Gloss color codes, see pg. 167



### Product family features

- Can be used in conjunction with the following dimmer(s) and switch(es): Abella®, Ceano®, Ariadni®, Glyder® and Rotary
- All Lutron wallplates are screwless, seamless and have no visible hardware; the front plate securely snaps into the alignment adapter plate
- Traditional wallplates can be paired with designer accessories to complete the look of any room
- Customize your traditional wallplate with engraving, contact customer service to get started at 1.888.LUTRON1

### Ganging and derating

- Traditional wallplates use standard ganging
- Requires fins to be removed from dimmers for proper spacing (“Fins Broken” ganging), see pg. 170
- May require derating (i.e., reduction of dimmer capacity due to fin removal), see Derating Tables, pg. 172

**Available finishes**

Use **BOLD** color code in model number (Example: FG-1-**AL**)

Gloss finishes



**WH**  
White



**LA**  
Light Almond



**AL**  
Almond



**IV**  
Ivory



**BL**  
Black

Metal finishes



**SS**  
Stainless Steel\*

\*Stainless Steel finish wallplates include black plastic trim/adaptor, visible from side. Match with separate Black (BL) controls.



**Wallplates for Abella®, Ceana®, Ariadni®, Glyder® and Rotary**



1-gang  
Stainless Steel\*  
W: 2.86 in (73mm); H: 4.60 in (117 mm);  
D: .23 in (5.8 mm)

FG-1-**CC**<sup>3</sup>  
FW-1-SS



3-gang  
Stainless Steel\*  
W: 6.48 in (165 mm); H: 4.60 in (117 mm);  
D: .23 in (5.8 mm)

FG-3-**CC**<sup>3</sup>  
FW-3-SS

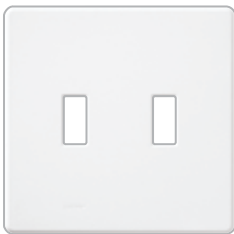

2-gang  
Stainless Steel\*  
W: 4.67 in (119 mm); H: 4.60 in (117 mm);  
D: .23 in (5.8 mm)

FG-2-**CC**<sup>3</sup>  
FW-2-SS

**Combination opening**



Rotate the wallplate for small/large or large/small opening applications.

2-gang (1 traditional,  
1 designer opening)  
Stainless Steel\*  
W: 4.67 in (119 mm); H: 4.60 in (117 mm);  
D: .23 in (5.8 mm)

FG-2-TD-**CC**<sup>3</sup>  
FW-2-TD-SS

Multiple devices with line and low-voltage can be mounted behind a common wallplate using a standard barrier backbox, see Application Note #213 (Combining Low-Voltage and Line Voltage Wiring Devices in a Multi-Gang Box) at [www.lutron.com/applicationnotes](http://www.lutron.com/applicationnotes).

Controls must have heat-sink fins broken for multi-gang installations. Removing this metal reduces the amount of heat that the control can dissipate, thus reducing the wattage capacity of the control. Please derate dimmers and switches as required.

Multi-gang dimmer installations may require derating, see pg. 170.

Controls must have heat-sink fins broken for multi-gang installations. Multi-gang dimmer installations may require derating, see pg. 170.

\*Stainless Steel wallplates include black plastic trim/adaptor, visible from side. Match with separate Black (BL) controls.

**CC**<sup>3</sup>: Gloss color codes, see pg. 167

## How to understand ganging and derating

### Standard ganging

Ganging is the side-by-side mounting of two or more dimmers or accessory devices under a multi-gang wallplate.

Standard multi-gang installation:

- Uses standard multi-gang electrical backboxes
- Uses standard multi-gang wallplates
- Requires fins to be removed from dimmers for proper spacing (“Fins Broken” ganging)
- May require derating (i.e., reduction of dimmer capacity due to fin removal), see Derating Tables, pgs. 172–173

### Custom ganging for Architectural style controls

For Architectural style dimmers and switches, it is possible to retain the maximum capacity of dimmers in multi-gang applications via custom architectural multi-gang:

- May require customized, wider-than-standard wallplates
- May require wider-than-standard electrical backboxes
- Allows full capacity (“No Fins Broken”) ganging
- Required for Nova® dimmers and for larger width (high capacity) architectural controls
- Visit [www.lutron.com/customganging](http://www.lutron.com/customganging) for additional information

## Standard ganging for dimmers, switches and accessories

### New Architectural



pg. 148

### Architectural



pg. 152

### Designer



pg. 160

### Traditional



pg. 166



Vierti®



Vareo®  
Nova T☆®



Maestro®  
Maestro IR®  
Maestro Wireless®  
Spacer System®  
Diva®  
Lyneo® Lx  
Skylark®  
Skylark Contour™



Abella®  
Ceana®  
Ariadni®  
Glyder®  
Rotary

Derating Table 1  
pg. 172

Derating Table 2  
pg. 173

Derating Table 1  
pg. 172

Derating Table 1  
pg. 172

## Standard ganging and fins broken derating examples:



## Custom Architectural ganging example:



For further information on ganging and derating, visit [www.lutron.com/multigang](http://www.lutron.com/multigang).

\*The fins are scored and designed to be removed easily.

**Derating Table 1**

**New Architectural** | Verti®

**Designer** | Maestro®, Maestro IR®, Maestro Wireless®, Spacer System®, Diva®, Lyneo® Lx, Skylark Contour™, Skylark®

**Traditional** | Abella®, Ceano®, Ariadni®, Glyder®, Rotary



**No fins broken**



**1 fin broken**



**2 fins broken**

	No fins broken	1 fin broken	2 fins broken
<b>Incandescent</b>			
Dimmers	600W	500W	400W
	1000W	800W	650W
Dual dimmers	300W	250W	200W
	300W	250W	200W
<b>Magnetic low-voltage</b>			
Dimmers	600VA/450W	500VA/400W	400VA/300W
	1000VA/800W	800VA/650W	650VA/500W
<b>Electronic low-voltage</b>			
Dimmers	300W	250W	200W
	500W	450W	400W
	600W	500W	400W
<b>Fluorescent</b>			
<b>Hi-lume®/Hi-lume® Compact SE/Eco-10®/EcoSystem®</b>			
Verti	60 ballasts/6A	50 ballasts/5A	35 ballasts/3.5A
Maestro/Spacer System	20 ballasts/6A	20 ballasts/5A	20 ballasts/3.5A
Diva, Skylark, Lyneo Lx and Ariadni	no derating	no derating	no derating
Tu-Wire®: Spacer System, Diva, Skylark	5A	4A	3.3A
<b>Fan controls</b>			
Quiet 7-speed	1.0A/300W	1.0A/300W	1.0A/300W
Quiet 3-speed	1.5A	1.5A	1.5A
Fully variable	5A	4A	3A
<b>Fan/light controls</b>			
Quiet 7-speed	1.0A/300W	1.0A/300W	1.0A/300W
Quiet 3-speed	1.5A/300W	1.5A/300W	1.5A/300W
	1.5A/360W	1.5A/360W	1.5A/360W
Fully variable	2.5A/300W	2.1A/250W	1.7A/200W
<b>Electronic switches</b>			
Verti	6A/3A	5A/3A	3.5A/3A
Maestro (light/fan)	8A/3A	6.5A/3A	5A/3A
Abella (light/fan)	6A/3A	5A/3A	3.5A/3A

**Derating Table 2**

**Architectural** | Vareo®, Nova T☆®



**No fins broken**



**1 fin broken**



**2 fins broken**

	No fins broken	1 fin broken	2 fins broken
<b>Incandescent</b>			
Dimmers	600W	500W	300W
	1000W	900W	700W
	1500W	1250W	1000W
	1950W	–	–
<b>Magnetic low-voltage</b>			
Dimmers	600 VA/450 W	500 VA/400 W	300 VA/250 W
	1000 VA/800 W	900 VA/750 W	700 VA/500 W
	1500 VA/1200 W	1250 VA/1000 W	1000 VA/800 W
<b>Electronic low-voltage</b>			
Dimmers	300W	300W	250W
	600W	500W	400W
<b>Fluorescent</b>			
<b>Hi-lume®/Hi-lume® Compact SE/Eco-10®/EcoSystem®</b>			
Vareo	20 ballasts /8 A	20 ballasts /6 A	20 ballasts /4.5 A
Nova T☆	6 A	no derating	no derating
	8 A	no derating	no derating
	16 A	no derating	no derating
0-10VDC control <sup>1</sup>	30mA ballasts	no derating	no derating
Tu-Wire®	5 A	4 A	3.3 A
<b>Fan controls</b>			
Quiet 3-speed	1.5 A	no derating	no derating
Fully variable	6 A	4.2 A	2.5 A
Fully variable	12 A	10 A	8.3 A
<b>Electronic tapswitches<sup>2</sup></b>			
VETS-1000-	1000W	800W	650W
VETS-1000-SL-	1000W	900W	700W
VETN-1000-	1000 VA	700 VA	550 VA

For further information on ganging Nova®, visit [www.lutron.com/customganging](http://www.lutron.com/customganging).

<sup>1</sup>PowerPack required for line voltage switching.

<sup>2</sup>VETS-R-Auxiliary electronic tapswitches do not require derating.

## Rotary

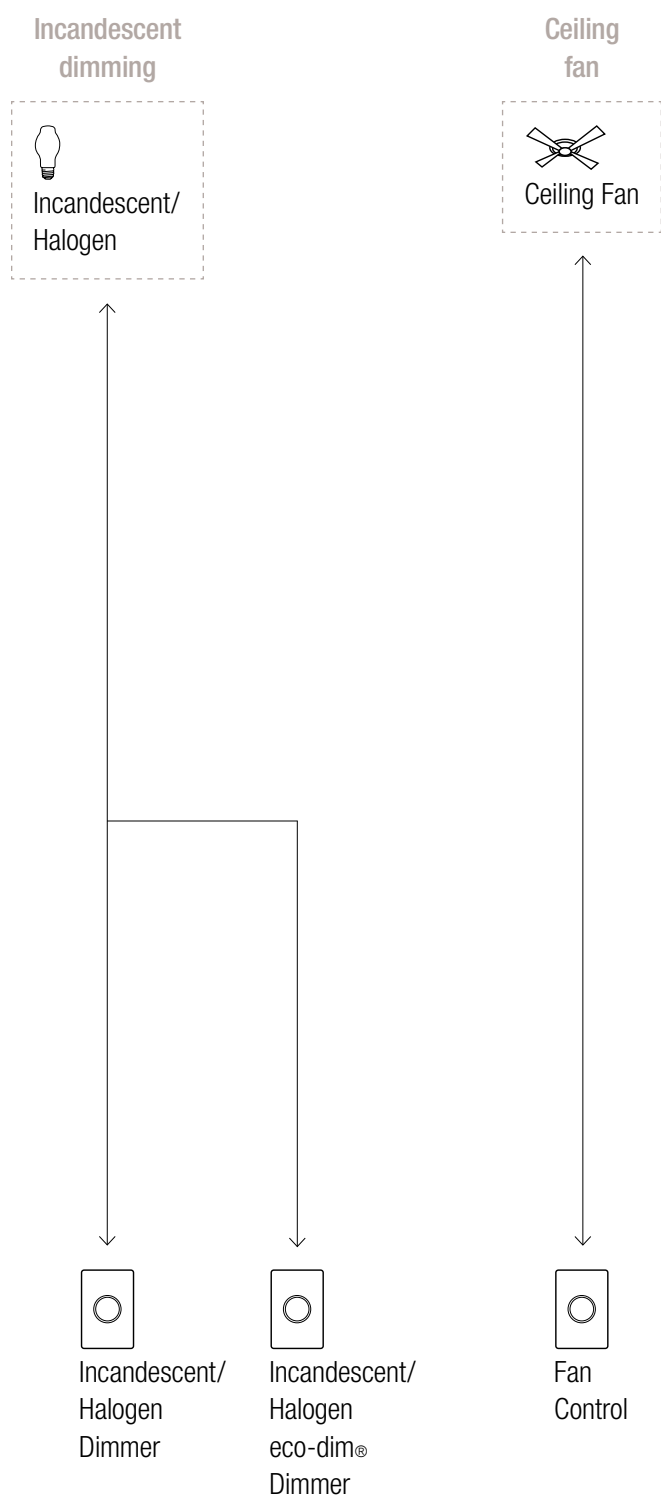

**For illustration purposes only.** Consult model number pages for specific voltage and capacity information.