

Industrial Fittings

Section F

Time-tested and innovative conduit fittings, cord connectors and cable glands move power where you need it simply and safely in any electrical installation.

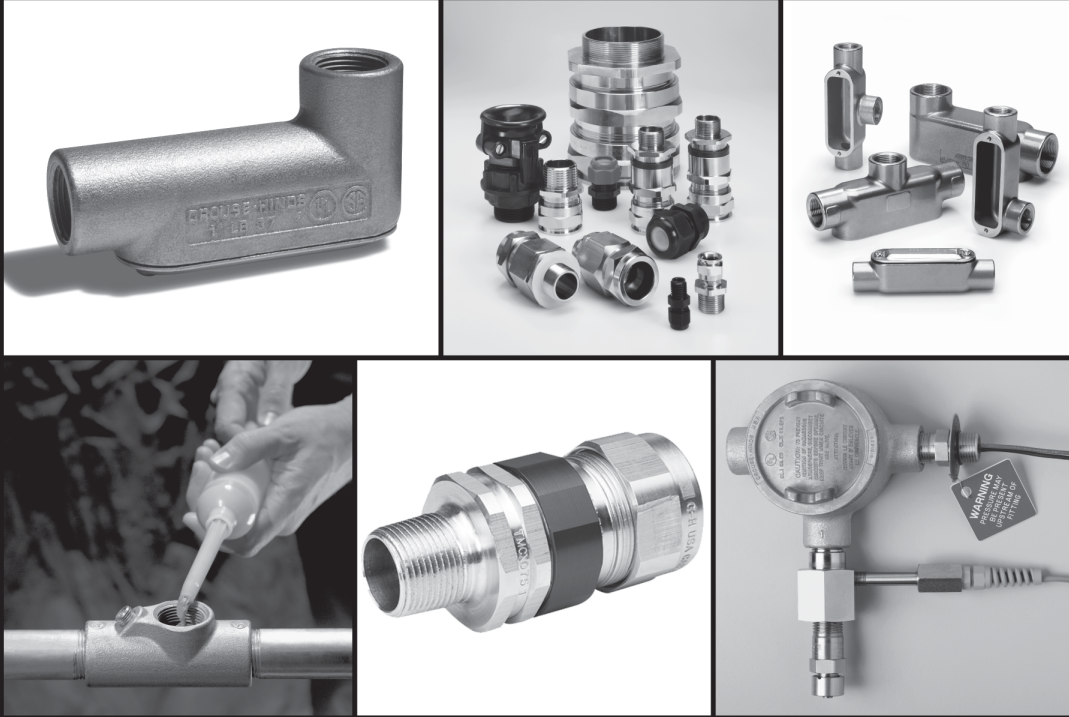

New Products in the Industrial Fittings Product Line

- Terminator™ II TMCX Cable Glands

Section

4F

F Electrical Fittings

Table of Contents

L

Section F of the Eaton's Crouse-Hinds Product Catalog lists a wide variety of conduit outlet bodies and boxes, cable fittings, unions, connectors, seals, breathers, and drains for both hazardous and non-hazardous area use. Information on applications, features, standard materials, standard finishes, options, size ranges, compliances, and accessories is presented for ease of product selection. Information relating to product families in Section F is grouped as follows:

Section 1F

Condulet® Conduit Bodies and Outlet Boxes

(for non-hazardous areas)

Conduit bodies for installation in conduit systems to act as pull outlets, make 90° bends, provide for splices, taps, mounting outlets, etc.

Form 7	Mogul	SLB
Form 8	LBD	LBY
Mark 9	LBNEC	ET
Form 5		
Series 5		
Form 7 SnapPack™		

Round cast outlet boxes and accessories for use in conjunction with threaded rigid conduit to serve as junction boxes, pull outlets, accommodate wiring devices and support lighting fixtures.

GRF	VXF
-----	-----

Section 2F

Condulet Device Boxes

(for non-hazardous areas)

For installation in conduit systems to:

- Accommodate wiring devices
- Act as pull boxes
- Provide openings for taps and splices

Provided in two box depths with a wide variety of hub configurations and sizes. Boxes can accommodate single or multiple devices.

FS	FD	Covers
----	----	--------

Section 3F

Condulet Conduit Bodies and Outlet Boxes

(for hazardous areas)

For use with rigid conduit systems:

- Act as pull and splice boxes
- Act as mounting outlets or supports for lighting fixtures
- Act as sealing fittings

CPS	ET	LBH	STL
EAB	GUA	LBY	EAJ
EKC	HTL	OE	GUR

Section 4F

Cable Glands and Cable Accessories

(for hazardous and non-hazardous areas)

Includes listings of cable and cord connectors and cable terminators for armoured and unarmoured cable and cord, and aluminum sheathed cable. Used to:

- Provide means for passing cord, cable or flexible conduit through bulkhead and into boxes and cabinets
- Form watertight seal
- Form non-slip connection or termination for flexible cord, cable or flexible conduit
- Provide grounding continuity

ADE 1F	ADE 6FC	LCC	TMC
ADE 4F	CGB	LCCF	Terminator™ II TMCX
ADE 6F	CGFP	TGC	TMCX
ADE 1FC	EBY	THRU-WALL	

Section 5F

Elbows, Couplings, Hubs, Grounding Devices, Plugs, Reducers, Service Entrance and Unions

(for hazardous and non-hazardous areas)

Includes:

- Service entrance heads
- Grounding receptacles and straps
- Unions and elbows for threaded conduit systems
- Couplings for use where allowance must be made in conduit system for difficult bends or vibration
- Reducers for connecting conduit of different dimensions
- Plugs for unused conduit openings and hubs

ECGJH	GC	LNR	UNA	UNY
ECLK	GCR	PLG	UNF	UNYL
EL	GCT	RE	UNFL	XD
F	HUBS	REC	UNL	XJG

Section 6F

Seals, Breathers and Drains

(for hazardous areas)

Includes:

- Seals used to prevent passage of gases or flames in conduit runs and from device enclosures
- Sealing/drain fittings for retrofit applications
- Breathers used to provide ventilation for enclosures
- Drains used to prevent accumulation of moisture in conduit systems and enclosures
- *Chico*® sealing compound and fiber

Seal	Seal and drain	Breather and drain
EYS	EYD	ECD
EZS	EZD	CD
EYSR	EYDX	
EYSX		
Secondary Process Sealing Fitting		
EYS Tool Kit		

Description	Page No.
Application/Selection	see page 4
Shape Selector Chart	see page 5
Conduit Bodies - Cast Iron or Aluminum	
Forms 7 & 8, Mark 9, Series 5 and Form 5	see pages 6–81
Form 7 SnapPack™	see page 9
Mogul Series	see pages 13–14
LBD Series	see page 15
LBNEC Mogul Pulling Elbows	see page 16
Covers for Cast Iron or Aluminum Conduit Bodies	
Blank	
Forms 7 & 8, Mark 9, Series 5 and Form 5	see page 8
Mogul Series	see pages 13–14
Gaskets for Cast Iron or Aluminum Conduit Bodies	
Forms 7 & 8, Mark 9, Series 5 and Form 5	see page 8
LBD Series	see page 15
Mogul Series	see pages 13–14
Conduit Bodies, Covers and Gaskets - Stainless Steel	
see pages 17–27	
Condulet® Outlet Boxes	
GRF Series	see page 19
VXF Series	see page 19
Service Entrance Elbows & Tees	
ET Tees	see page 20
LBV & SLB Elbows	see page 20



1F Condulet® Conduit Bodies and Outlet Boxes

Application and Selection



Applications:

- Conduit bodies and outlet boxes are installed at appropriate locations in threaded rigid conduit systems to:
- Act as pull outlets for conductors to be installed in a conduit system
 - Provide openings for splices and taps in conductors
 - Act as mounting outlets for luminaires and wiring devices, or as support for luminaires (with hub and fixture hanging covers)
 - Act as junction or fuse boxes when fitted with connection blocks or fuse blocks
 - Connect conduit sections and change direction of conduit runs
 - Make 90° bends in conduit runs
 - Provide access to conductors for maintenance and future system changes

Considerations for Selection:

- Shape required – determine from configuration of conduit system and intended function of conduit bodies or outlet boxes
- Size required – determine from conduit and conductor size
- Material required – determine from environmental conditions (corrosive fumes, buried in concrete, etc.)

Quick Selector Chart - Conduit Bodies

Series	Conduit Sizes	Configuration Styles	Standard Material
Form 7	1/2" - 4"	C, E, L, LB, LL, LR, T, TA, TB and X	Feraloy® iron or aluminum
Form 8	1/2" - 4"	C, LB, LL, LR, T, TB and X	Feraloy iron
Mark 9	1/2" - 4"	C, LB, LL, LR, T, TB and X	Copper-free aluminum
Form 5	1/2" - 4"	C, LB, LL, LR, T, TB and X	Durable malleable iron construction
Series 5	1/2" - 4"	C, LB, LL, LR and T	Corrosion-resistant copper-free aluminum construction













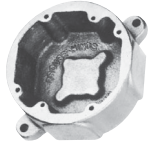









Quick Selector Chart - Conduit Outlet Boxes

Series	Conduit Sizes	Inside Dimensions		No. of Conduit Openings	Surface or Flush Mtg.	Standard Material	Finish	Covers
		Depth	Dia.					
VXF	1/2 and 3/4	1 3/4	4 1/4	4 or 5	S	Copper-free aluminum	Epoxy enamel	When box is used as junction or pull box, install GRF covers, gaskets.
GRF	1/2 to 1	1 3/8 to 3 1/8	3 11/16	0 to 4	S - F	Feraloy iron alloy or aluminum	Electrogalvanized and aluminum paint	Blank, hub, standard 4" octagonal box covers, wiring devices, lighting fixture hangers, gaskets.

Condulet® Conduit Bodies and Outlet Boxes

1F

Shape Selector Chart

Series	Page	Series	Page	Series	Page
C		T		GRF	
 <p>Form 7 Form 8 Mark 9 Form 5 Series 5</p>	see pages 6-12 see pages 6-12 see pages 6-12 see pages 6-12 see pages 6-12	 <p>Form 7 Form 8 Mark 9 Form 5 Series 5</p>	see pages 6-12 see pages 6-12 see pages 6-12 see pages 6-12 see pages 6-12	 <p>Outlet Box</p>	see page 19
E		TB		BT	
 <p>Form 7</p>	see pages 6-12	 <p>Form 7 Form 8 Mark 9 Form 5</p>	see pages 6-12 see pages 6-12 see pages 6-12 see pages 6-12	 <p>Mogul</p>	see pages 13-14
LB		X		LBD	
 <p>Form 7 Form 8 Mark 9 Form 5 Series 5</p>	see pages 6-12 see pages 6-12 see pages 6-12 see pages 6-12 see pages 6-12	 <p>Form 7 Form 8 Mark 9 Form 5</p>	see pages 6-12 see pages 6-12 see pages 6-12 see pages 6-12	 <p>1/2 - 1"</p>	see page 15
LL		LBNEC		LBD	
 <p>Form 7 Form 8 Mark 9 Form 5 Series 5</p>	see pages 6-12 see pages 6-12 see pages 6-12 see pages 6-12 see pages 6-12	 <p>LBNEC</p>	see page 16	 <p>1 1/4 - 6"</p>	see page 15
LR		BC		SLB	
 <p>Form 7 Form 8 Mark 9 Form 5 Series 5</p>	see pages 6-12 see pages 6-12 see pages 6-12 see pages 6-12 see pages 6-12	 <p>Mogul</p>	see pages 13-14	 <p>Service Entrance Elbows</p>	see page 20
L		BLB		LBY	
 <p>Form 7</p>	see pages 6-12	 <p>Mogul</p>	see pages 13-14	 <p>Service Entrance Elbows</p>	see page 20
TA		BUB		ET	
 <p>Form 7</p>	see pages 6-12	 <p>Mogul</p>	see pages 13-14	 <p>Service Entrance Elbows</p>	see page 20
		VXF			
		 <p>Outlet Box</p>	see page 19		

1F Condulet® Conduit Bodies - Cast Iron or Aluminum

Gasket and Covers see page 8

1F

Applications:

- Conduit outlet bodies are installed in conduit systems to:
- Act as pull outlets for conductors being installed
 - Provide openings for making splices and taps in conductors
 - Connect conduit sections
 - Provide taps for branch conduit runs
 - Make 90° bends in conduit runs
 - Provide for access to conductors for maintenance and future system changes

Features:

Conduit Outlet Bodies

- Form 7 Condulet outlet bodies approach conduit in size for neat, compact installations
- Form 8 and Mark 9 bodies provide more room for heavier conductors
- Many shapes and sizes are available for rigid threaded conduit – for complete listings see pages 6–12
- Conduit hubs have tapered threads and feature integral bushings for protection of wire insulation
- Form 7 has exclusive snaptight and wedgenut cover attachment to provide clear, unobstructed cover opening
- Built-in rollers on all Form 5 1 1/4" to 4" C and LB bodies to facilitate wire pulling
- Series 5 bodies available in optional configuration with set screws on hubs for EMT conduit (add suffix -MT to catalog number)

Gaskets

Solid gaskets:

- Are used with blank covers
- For Mark 9 and Form 5, can be converted to open type gaskets by tearing out center section along scored lines – 1/2" to 2" sizes
- For Form 7 are used with all covers

Open gaskets:

- For Form 8 – 1/2" to 4" sizes
- For Mark 9 – 2 1/2" to 4" sizes

Blank Covers

Stainless steel cover screws are standard on Form 7, Form 8, Mark 9, Series 5 and Form 5 covers.

• Form 7

Wedge nut design facilitates installation and removal. Nuts are held captive in cover. Covers can be used with or without gaskets. SNAPTIGHT™ Form 7 Covers with integral sealing gaskets are installed without the use of screws, reducing installation time and costs. Covers are reusable.

• Form 8

Two cover screws provided on all sizes to provide tight cover and gasket assembly. *Feraloy* iron alloy covers have dome shapes for added strength and extra wiring room.

• Mark 9

Self-retaining cover screws.

Certifications and Compliances:

Outlet Bodies –

- UL Standard: 514B
- Fed. Spec.: W-C-586D
- CSA Standard 22.2 No. 18
- NEMA 3R Raintight (when installed with cover and gasket)

Standard Materials:

- Form 7, Form 8 outlet bodies – *Feraloy* iron alloy
- Mark 9 outlet bodies – copper-free aluminum
- Form 5 – malleable iron
- Series 5 – die cast aluminum

Standard Finishes:

- Form 7, Form 8 outlet bodies – electrogalvanized with aluminum acrylic paint
- Mark 9 outlet bodies – natural
- Form 5 – electrogalvanized with aluminum acrylic paint
- Series 5 – aluminum acrylic paint

Options:

Description	Suffix
Form 7 body and cover only:	
Copper-free aluminum	SA
<i>Corro-free</i> ™ epoxy powder coat - external body only	S752
<i>Corro-free</i> ™ epoxy powder coat - internal and external	S753
Series 5 in an EMT version with set screws on all hubs	MT
Series 5 pre-packaged with neoprene gasket and cover	CGN



Form 7



Mark 9

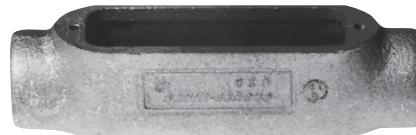

Form 8











Mogul

Condulet® Conduit Bodies - Cast Iron or Aluminum

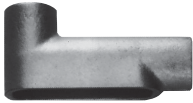
1F

Dimensions Pgs. See pages 10–12 (Dimensions for Form 5 – see Section CP)

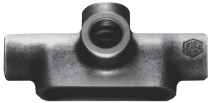
Threaded Rigid Bodies

Shape	Style	Hub Size										
		1/2	3/4	1	1 1/4	1 1/2	2	2 1/2	3	3 1/2	4	
	C											
	Form 7	C17	C27	C37	C47	C57	C67	C77	C87			
	Form 8	C18	C28	C38	C448	C58	C68	C78	C88			
	Mark 9	C19	C29	C39	C49	C59	C69	C789	C889	C989	C1089	
	Form 5	C50M	C75M	C100M	C125M*	C150M*	C200M*	C250M*	C300M*	C350M*	C400M*	
Series 5	C15	C25	C35	C45	C55	C65	C75	C85	C95*	C105*		
	E											
	Form 7	E17	E27	E37								
	L											
	Form 7	L17	L27	L37	L47	L57	L67					
Double faced – may be used as LL or LR – has 2 openings, one of which is furnished with a blank sheet steel cover												
	LB											
	Form 7	LB17	LB27	LB37	LB47	LB57	LB67	LB777	LB87	LB97	LB107	
	Form 8	LB18	LB28	LB38	LB448	LB58	LB68	LB78	LB888	LB98	LB108	
	Mark 9	LB19	LB29	LB39	LB49	LB59	LB69	LB789	LB889	LB989	LB1089	
	Form 5	LB50M	LB75M	LB100M	LB125M*	LB150M*	LB200M*	LB250M*	LB300M*	LB350M*	LB400M*	
Series 5	LB15	LB25	LB35	LB45	LB55	LB65	LB75	LB85	LB95	LB105		
	LL											
	Form 7	LL17	LL27	LL37	LL47	LL57	LL67	LL777	LL87	LL97	LL107	
	Form 8	LL18	LL28	LL38	LL448	LL58	LL68	LL78	LL888			
	Mark 9	LL19	LL29	LL39	LL49	LL59	LL69	LL789	LL889	LL989	LL1089	
	Form 5	LL50M	LL75M	LL100M	LL125M	LL150M	LL200M	LL250M	LL300M	LL350M	LL400M	
Series 5	LL15	LL25	LL35	LL45	LL55	LL65	LL75	LL85	LL95	LL105		
	LR											
	Form 7	LR17	LR27	LR37	LR47	LR57	LR67	LR777	LR87	LR97	LR107	
	Form 8	LR18	LR28	LR38	LR448	LR58	LR68	LR78	LR888			
	Mark 9	LR19	LR29	LR39	LR49	LR59	LR69	LR789	LR889	LR989	LR1089	
	Form 5	LR50M	LR75M	LR100M	LR125M	LR150M	LR200M	LR250M	LR300M	LR350M	LR400M	
Series 5	LR15	LR25	LR35	LR45	LR55	LR65	LR75	LR85	LR95	LR105		
	T											
	Form 7	T17	T27	T37	T47	T57	T67	T77	T87	T97	T107	
	Form 8	T18	T28	T38	T448	T58	T68	T78	T88			
	Mark 9	T19	T29	T39	T49	T59	T69	T789	T889	T989	T1089	
	Form 5	T50M	T75M	T100M	T125M	T150M	T200M	T250M	T300M	T350M	T400M	
Series 5	T15	T25	T35	T45	T55	T65	T75	T85	T95*	T105*		
	TA											
	Form 7	TA17	TA27	TA37	TA47	TA57	TA67					
	TB											
	Form 7	TB17	TB27	TB37	TB47	TB57	TB67					
	Form 8	TB18	TB28	TB38	TB448	TB58	TB68					
	Mark 9	TB19	TB29	TB39	TB49	TB59	TB69					
	Form 5	TB15	TB25	TB35	TB45	TB55	TB65					
Series 5	TB50M	TB75M	TB100M	TB125M	TB150M	TB200M						
	X											
	Form 7	X17	X27	X37	X47	X57	X67					
	Form 8	X18	X28	X38	X448	X58	X68					
	Mark 9	X19	X29	X39								
	Form 5	X15	X25	X35	X45	X55	X65					
Series 5	X50M	X75M	X100M	X125M	X150M	X200M						

* 1/2" - 4" Form 5 LB and C bodies are supplied with built-in rollers to facilitate wire pulling.

1F Condulet® Conduit Bodies - Cast Iron or Aluminum

Covers and Gaskets

Dimensions Pgs. See pages 10-12 (Dimensions for Form 5 - see Section CP)

1F

Blank Covers



Sheet Steel

Size	Form 7 Wedgenut Cat. #	Form 7 Snaptight™ Covers‡ Cat. #	Form 7 Wedgenut w/Integral Gasket Cat. #	Form 8§ Cat. #	Form 8 w/Integral Gasket Cat. #	Form 5 w/Integral Gasket** Cat. #
1/2	170	170SG	170G	180	180G	K50SG
3/4	270	270SG	270G	280	280G	K75SG
1	370	370SG	370G	380	380G	K100SG
1 1/4	470	470SG	470G	480	480G	K125SG
1 1/2	570	570SG	570G	580	580G	K125SG
2	670	670SG	670G	680	680G	K200SG
2 1/2	870	870G		880		K250SG
3	870			880		K250SG
3 1/2	970	970G		980		K350SG
4	970			980		K350SG

‡Form 7 Snaptight covers with integral sealing gasket are installed without the use of screws.
§Two cover screws on 1/2" to 2" Form 8 covers and four cover screws on 2 1/2" and larger Form 8 covers.
**For cover without integral gasket, remove G from catalog number.



Sheet Aluminum



Feraloy® Iron Alloy



Cast Aluminum

Size	Mark 9 Cat. #	Mark 9 w/Integral Gasket Cat. #	Form 7 Cat. #	Form 7 w/Integral Gasket Cat. #	Series 5 w/Integral Gasket** Cat. #	Form 7 Wedgenut Cat. #	Form 7 Wedgenut w/Integral Gasket Cat. #	Form 8§ Cat. #	Form 5‡ Cat. #	Form 7 Wedgenut Cat. #
1/2	190	190G	170 SA	170G SA	150 G	170F	170FG	180F	K50CM	170F SA
3/4	290	290G	270 SA	270G SA	250 G	270F	270FG	280F	K75CM	270F SA
1	390	390G	370 SA	370G SA	350 G	370F	370FG	380F	K100CM	370F SA
1 1/4	490	490G	470 SA	470G SA	450 G	470F	470FG	480F	K125CM	470F SA
1 1/2	590	590G	570 SA	570G SA	450 G	570F	570FG	580F	K125CM	570F SA
2	690	690G	670 SA	670G SA	650 G	670F	670FG	680F	K200CM	670F SA
2 1/2	889		870 SA		850 G	870F		880F	K250CM	870F SA
3	889		870 SA		850 G	870F		880F	K250CM	870F SA
3 1/2	989		970 SA		950 G	970F		980F	K350CM	970F SA
4	989		970 SA		950 G	970F		980F	K350CM	970F SA

‡Malleable iron covers.
§Two cover screws on 1/2" to 2" Form 8 covers and four cover screws on 2 1/2" and larger Form 8 covers.
**For cover without integral gasket, remove G from catalog number.

Solid Gaskets - Neoprene



Size	Form 7 Cat. #	Form 8* Cat. #	Mark 9† Cat. #	Form 5 Cat. #	Series 5 Cat. #
1/2	GASK571	GASK851N	GASK1941	GK50N	GASK015N
3/4	GASK572	GASK852N	GASK1942	GK75N	GASK025N
1	GASK573	GASK853N	GASK1943	GK100N	GASK035N
1 1/4	GASK574	GASK854N	GASK1944	GK125N	GASK045N
1 1/2	GASK575	GASK805N	GASK1945	GK125N	GASK045N
2	GASK576	GASK806N	GASK1946	GK200N	GASK065N
2 1/2	GASK578	GASK808N	GASK808N	GK250N	GASK085N
3	GASK578	GASK808N	GASK808N	GK250N	GASK085N
3 1/2	GASK579	GASK809N	GASK809N	GK350N	GASK095N
4	GASK579	GASK809N	GASK809N	GK350N	GASK095N

*1/2 - 1 1/4 are solid gaskets; 1 1/2 - 4 are open gaskets.
†1/2 - 2 are solid gaskets; 2 1/2 - 4 are open gaskets.

Form 7 SnapPack™ Pre-Assembled Body, Gasket and Cover

Applications:

Form 7 Condulets are installed in conduit systems to:

- Act as pull outlets for conductors being installed
- Provide an opening for making splices and taps in conductors
- Connect conduit sections
- Provide taps for branch conduit runs
- Make 90-degree bends in conduit runs
- Provide access to conductors in a conduit system for maintenance and future system changes

Features:

- All SnapPack product is individually bar coded to facilitate more efficient inventory control
- Distributors and end-users need to stock a single SKU instead of three separate component numbers – order the body, cover and gasket with one catalog number – saving transaction costs, and making product selection and merchandising fast and easy
- Form 7 conduit bodies are compact with a round back design for neat, efficient installations
- Conduit hubs have tapered threads and integral bushings for protection of wire insulation
- Many shapes and trade sizes available
- Sheet-steel wedge nut cover is provided with integral gasket. The wedge nut design facilitates installation and removal. Nuts and screws are held captive in cover
- Cover screws are stainless steel with a combination slotted and Phillips head, for easy installation and superior corrosion protection

Certifications and Compliances:

- UL Standard: 514B
- CSA Standard: C22.2 No. 18

Standard Materials:

- Body – *Feraloy*® iron alloy
- Gasket – urethane
- Cover – sheet steel
- Cover screws – stainless steel

Standard Finishes:

- *Feraloy* – electrogalvanized with aluminum acrylic paint
- Sheet steel – electrogalvanized

Ordering Information

Trade Size	Shape	Cat. #
1/2"	C	C17 CG
3/4"	C	C27 CG
1"	C	C37 CG
1 1/4"	C	C47 CG
1 1/2"	C	C57 CG
2"	C	C67 CG
1/2"	LB	LB17 CG
3/4"	LB	LB27 CG
1"	LB	LB37 CG
1 1/4"	LB	LB47 CG
1 1/2"	LB	LB57 CG
2"	LB	LB67 CG
1/2"	LL	LL17 CG
3/4"	LL	LL27 CG
1"	LL	LL37 CG
1 1/4"	LL	LL47 CG
1 1/2"	LL	LL57 CG
2"	LL	LL67 CG
1/2"	LR	LR17 CG
3/4"	LR	LR27 CG
1"	LR	LR37 CG
1 1/4"	LR	LR47 CG
1 1/2"	LR	LR57 CG
2"	LR	LR67 CG
1/2"	T	T17 CG
3/4"	T	T27 CG
1"	T	T37 CG
1 1/4"	T	T47 CG
1 1/2"	T	T57 CG
2"	T	T67 CG
1/2"	TB	TB17 CG
3/4"	TB	TB27 CG
1"	TB	TB37 CG
1 1/4"	TB	TB47 CG
1 1/2"	TB	TB57 CG
2"	TB	TB67 CG
1/2"	X	X17 CG
3/4"	X	X27 CG
1"	X	X37 CG
1 1/4"	X	X47 CG
1 1/2"	X	X57 CG
2"	X	X67 CG



Form 7 Condulets and covers are available in additional configurations, sizes and materials. For a complete listing of Form 7, Form 8 and Mark 9 conduit bodies and covers see pages 6–12.



1F Condulet® Conduit Bodies - Cast Iron or Aluminum

Dimensions (In Inches)

1F

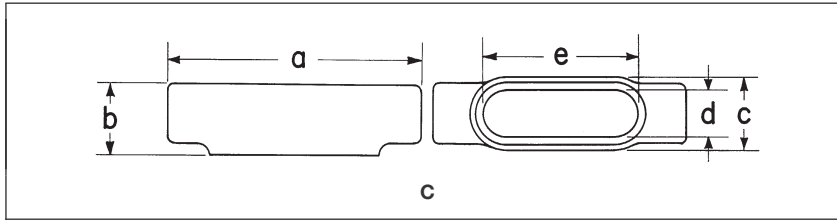

Form 7 C

Size	1/2	3/4	1	1 1/4	1 1/2	2	2 1/2	3
a	5 3/8	6	7	7 7/16	8 3/16	9 3/16	12	11 3/4
b	1 3/8	1 5/8	1 7/8	2 5/16	2 9/16	3 1/8	3 5/8	4 3/8
c	1 3/8	1 9/16	1 3/4	2 3/16	2 7/16	3	4 1/4	4 1/4
d	1 5/16	1 1/8	1 3/8	1 3/4	1 15/16	2 7/16	3 3/16	3 9/16
e	3 3/16	3 13/16	4 1/2	5	5 7/16	6 3/8	8 3/8	8 3/8

Form 8 C

Size	1/2	3/4	1	1 1/4	1 1/2	2	2 1/2	3
a	5 11/16	6 9/32	7 7/16	8 1/2	10 3/8	12 1/4	15 5/8	15 5/8
b	1 7/16	1 11/16	1 15/16	2 3/8	2 25/32	3 3/16	4 7/16	4 13/16
c	1 3/8	1 3/16	1 3/4	2 3/16	2 3/4	3 3/4	5	5
d	1	1 3/16	1 3/8	1 3/4	2 1/8	3	4 1/4	4 1/4
e	3 5/16	3 15/16	4 9/16	5 5/16	6 1/2	8 9/16	10 7/8	10 7/8

Mark 9 C

Size	1/2	3/4	1	1 1/4	1 1/2	2	2 1/2	3	3 1/2	4
a	5	5 11/16	6 10/32	7 1/2	8 3/4	10 1/2	15 5/8	15 5/8	18 3/4	18 3/4
b	1 3/8	1 5/8	1 7/8	2 1/2	2 3/4	3 7/16	4 7/16	4 13/16	5 11/16	5 15/16
c	1 3/8	1 9/16	1 3/4	2 3/16	2 1/2	3 3/16	5	5	6 1/4	6 1/4
d	1 3/16	1 3/8	1 1/2	1 15/16	2 1/4	2 7/8	4 1/4	4 1/4	5 7/16	5 7/16
e	3 3/16	3 15/16	4 9/16	5 5/16	6	8 7/16	10 7/8	10 7/8	13 7/16	13 7/16

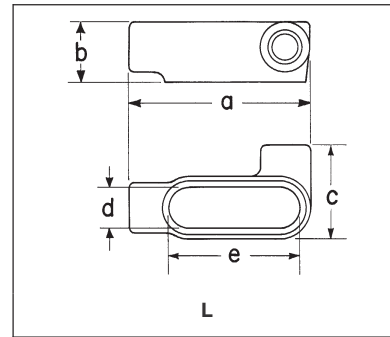
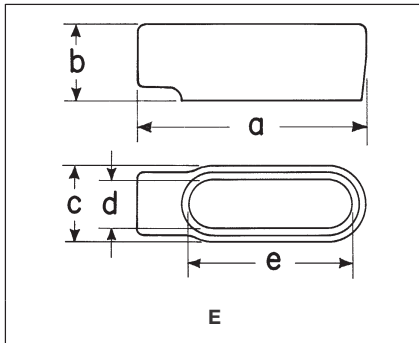

Form 7 E

Size	1/2	3/4	1
a	4 3/16	5 3/16	6
b	1 3/8	1 5/8	1 7/8
c	1 3/8	1 9/16	1 3/4
d	1 5/16	1 1/8	1 3/8
e	3 3/16	3 13/16	4 1/2

Form 7 L

Size	1/2	3/4	1	1 1/4	1 1/2	2
a	4 9/16	5 3/16	6	6 1/2	7 1/8	8 3/8
b	1 3/8	1 5/8	1 7/8	2 5/16	2 9/16	3 1/8
c	2 1/4	2 7/16	2 3/4	3 3/16	3 9/16	4 1/8
d	1 5/16	1 1/8	1 3/8	1 3/4	1 15/16	2 7/16
e	3 3/16	3 13/16	4 1/2	5	5 7/16	6 3/8

Condulet® Conduit Bodies - Cast Iron or Aluminum

1F

Dimensions (In Inches)

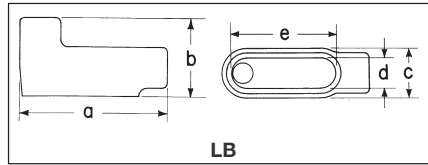

Form 7 LB

Size	1/2	3/4	1	1 1/4	1 1/2	2	2 1/2	3	3 1/2	4
a	4 9/16	5 3/16	6	6 1/2	7 1/8	8 5/8	10 1/2	10 1/2	12 11/16	12 11/16
b	2 1/4	2 1/2	2 7/8	3 9/16	3 11/16	4 1/4	5 1/8	5 7/8	6 9/16	7 1/16
c	1 3/8	1 9/16	1 3/4	2 3/16	2 7/16	3	4 1/4	4 1/4	5 1/4	5 1/4
d	1 5/16	1 1/8	1 3/8	1 3/4	1 15/16	2 7/16	3 9/16	3 9/16	4 1/2	4 1/2
e	3 3/16	3 13/16	4 1/2	5	5 7/16	6 3/8	8 3/8	8 3/8	10 1/4	10 1/4

Form 8 LB

Size	1/2	3/4	1	1 1/4	1 1/2	2	2 1/2	3	3 1/2	4
a	4 15/16	5 9/16	6 15/32	7 17/32	9 1/8	11	13 15/16	13 15/16	16 7/8	16 7/8
b	2 7/32	2 7/16	2 19/16	3 11/32	4 1/32	4 13/16	6 1/8	6 1/2	7 9/16	7 13/16
c	1 3/8	1 9/16	1 3/4	2 3/16	2 3/4	3 3/4	5	5	6 1/4	6 1/4
d	1	1 3/16	1 3/8	1 3/4	2 1/8	3	4 1/4	4 1/4	5 7/16	5 7/16
e	3 5/16	3 15/16	4 9/16	5 5/16	6 1/2	8 9/16	10 7/8	10 7/8	13 7/16	13 7/16

Mark 9 LB

Size	1/2	3/4	1	1 1/4	1 1/2	2	2 1/2	3	3 1/2	4
a	4 19/32	5 1/4	6 3/32	7 1/32	7 3/4	10 1/32	13 15/16	13 15/16	16 7/8	16 7/8
b	2 1/8	2 13/32	2 27/32	3 15/32	3 3/4	4 15/32	6 1/8	6 1/2	7 9/16	7 13/16
c	1 3/8	1 9/16	1 3/4	2 3/16	2 1/2	3 3/16	5	5	6 1/4	6 1/4
d	1 3/16	1 3/8	1 1/2	1 15/16	2 1/4	2 7/8	4 1/4	4 1/4	5 7/16	5 7/16
e	3 5/16	3 15/16	4 9/16	5 5/16	6	8 1/16	10 7/8	10 7/8	13 7/16	13 7/16



Form 7 LL & LR

Size	1/2	3/4	1	1 1/4	1 1/2	2	2 1/2	3	3 1/2	4
a	4 9/16	5 3/16	6	6 1/2	7 1/8	8 5/8	10 1/2	10 1/2	12 11/16	12 11/16
b	1 3/8	1 3/8	1 7/8	2 3/16	2 9/16	3 3/8	3 3/8	4 3/8	4 7/8	5 3/8
c	2 1/4	2 7/16	2 3/4	3 3/16	3 9/16	4 1/8	5 1/4	5 1/4	6 15/16	6 15/16
d	1 5/16	1 1/8	1 3/8	1 3/4	1 15/16	2 7/16	3 9/16	3 9/16	4 1/2	4 1/2
e	3 3/16	3 13/16	4 1/2	5	5 7/16	6 3/8	8 3/8	8 3/8	10 1/4	10 1/4

Form 8 LL & LR

Size	1/2	3/4	1	1 1/4	1 1/2	2	2 1/2	3
a	4 15/16	5 9/16	6 15/32	7 17/32	9 1/8	11	13 15/16	13 15/16
b	1 7/16	1 11/16	1 15/16	2 3/8	2 25/32	3 3/16	4 7/16	4 13/16
c	2 5/32	2 5/16	2 5/8	3 3/32	4	5	6 11/16	6 11/16
d	1	1 3/16	1 3/8	1 3/4	2 1/8	3	4 1/4	4 1/4
e	3 5/16	3 15/16	4 9/16	5 5/16	6 1/2	8 9/16	10 7/8	10 7/8

Mark 9 LL & LR

Size	1/2	3/4	1	1 1/4	1 1/2	2	2 1/2	3	3 1/2	4
a	4 19/32	5 1/4	6 3/32	7 1/32	7 3/4	10 1/32	13 15/16	13 15/16	16 7/8	16 7/8
b	1 3/8	1 3/8	1 7/8	2 1/2	2 3/4	3 7/16	4 7/16	4 3/16	5 11/16	5 15/16
c	2 1/8	2 3/8	2 5/8	3 3/32	3 7/16	4 1/8	5 1/16	6 11/16	8 1/8	8 1/8
d	1 3/16	1 3/8	1 1/2	1 15/16	2 1/4	2 7/8	4 1/4	4 1/4	5 7/16	5 7/16
e	3 5/16	3 15/16	4 9/16	5 5/16	6	8 1/16	10 7/8	10 7/8	13 7/16	13 7/16

Crouse-Hinds

by E.T.N

1F Condulet® Conduit Bodies - Cast Iron or Aluminum

Dimensions (In Inches)

1F

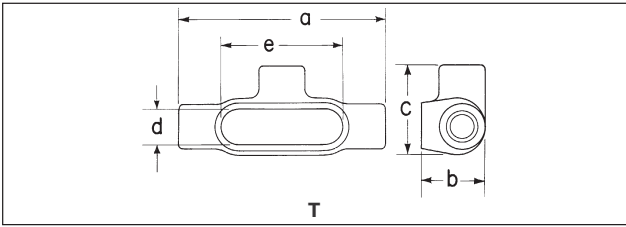

Form 7T

Size	a	b	c	d	e
1/2	5 ⁵ / ₈	1 ³ / ₄	2 ⁷ / ₁₆	1 ⁵ / ₁₆	3 ³ / ₁₆
3/4	6 ¹ / ₄	2	2 ⁵ / ₈	1 ¹ / ₈	3 ¹³ / ₁₆
1	7 ¹ / ₄	2 ¹ / ₄	3	1 ³ / ₈	4 ¹ / ₂
1 ¹ / ₄	7 ⁷ / ₁₆	2 ⁵ / ₁₆	3 ³ / ₁₆	1 ³ / ₄	5
1 ¹ / ₂	8 ³ / ₁₆	2 ⁹ / ₁₆	3 ³ / ₁₆	1 ¹⁵ / ₁₆	5 ⁷ / ₁₆
2	9 ⁹ / ₁₆	3 ¹ / ₈	4 ¹ / ₈	2 ⁷ / ₁₆	6 ³ / ₈
2 ¹ / ₂	12	3 ⁵ / ₈	5 ³ / ₄	3 ³ / ₁₆	8 ³ / ₈
3	12 ¹ / ₁₆	4 ³ / ₈	5 ³ / ₄	3 ³ / ₁₆	8 ³ / ₈
3 ¹ / ₂	14 ⁵ / ₁₆	4 ⁷ / ₈	6 ¹⁵ / ₁₆	4 ¹ / ₂	10 ¹ / ₄
4	14 ³ / ₁₆	5 ³ / ₈	6 ¹⁵ / ₁₆	4 ¹ / ₂	10 ¹ / ₄

Form 8T

1/2	5 ¹¹ / ₁₆	1 ³ / ₄	2 ⁵ / ₃₂	1	3 ⁵ / ₁₆
3/4	6 ⁹ / ₃₂	2	2 ⁹ / ₁₆	1 ³ / ₈	3 ¹⁵ / ₁₆
1	7 ⁵ / ₁₆	2 ¹ / ₄	2 ⁵ / ₈	1 ³ / ₈	4 ⁹ / ₁₆
1 ¹ / ₄	8 ¹ / ₂	2 ⁵ / ₈	3 ⁵ / ₃₂	1 ³ / ₄	5 ⁵ / ₁₆
1 ¹ / ₂	10 ⁹ / ₁₆	2 ²⁵ / ₃₂	4	2 ¹ / ₈	6 ¹ / ₂
2	12 ¹ / ₄	3 ⁹ / ₁₆	5	3	8 ⁷ / ₁₆
2 ¹ / ₂	15 ⁵ / ₈	4 ⁷ / ₁₆	6 ¹¹ / ₁₆	4 ¹ / ₄	10 ⁷ / ₈
3	15 ⁵ / ₈	4 ¹³ / ₁₆	6 ¹¹ / ₁₆	4 ¹ / ₄	10 ⁷ / ₈

Mark 9T

1/2	5	1 ³ / ₈	2 ¹ / ₈	1 ¹ / ₁₆	3 ⁵ / ₁₆
3/4	5 ¹¹ / ₁₆	1 ⁵ / ₈	2 ³ / ₈	1 ³ / ₈	3 ¹⁵ / ₁₆
1	6 ¹⁹ / ₃₂	1 ⁷ / ₈	2 ⁵ / ₈	1 ¹ / ₂	4 ⁹ / ₁₆
1 ¹ / ₄	7 ¹ / ₂	2 ¹ / ₂	3 ³ / ₃₂	1 ¹⁵ / ₁₆	5 ⁵ / ₁₆
1 ¹ / ₂	8 ¹ / ₄	2 ³ / ₄	3 ⁷ / ₁₆	2 ¹ / ₄	6
2	10 ¹ / ₂	3 ⁷ / ₁₆	4 ¹ / ₈	2 ⁷ / ₈	8 ¹ / ₁₆
2 ¹ / ₂	15 ⁵ / ₈	4 ⁷ / ₁₆	6 ¹¹ / ₁₆	4 ¹ / ₄	10 ⁷ / ₈
3	15 ⁵ / ₈	4 ¹³ / ₁₆	6 ¹¹ / ₁₆	4 ¹ / ₄	10 ⁷ / ₈
3 ¹ / ₂	18 ³ / ₄	5 ¹¹ / ₁₆	8 ¹ / ₈	5 ⁷ / ₁₆	13 ⁷ / ₁₆
4	18 ³ / ₄	5 ¹⁵ / ₁₆	8 ¹ / ₈	5 ⁷ / ₁₆	13 ⁷ / ₁₆

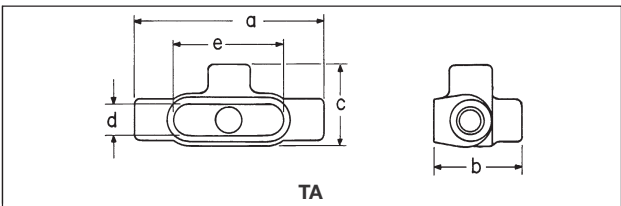

Form 7TA

Size	a	b	c	d	e
1/2	5 ⁵ / ₈	2 ⁵ / ₈	2 ⁷ / ₁₆	1 ⁵ / ₁₆	3 ³ / ₁₆
3/4	6 ¹ / ₄	2 ⁷ / ₈	2 ⁵ / ₈	1 ¹ / ₈	3 ¹³ / ₁₆
1	7 ¹ / ₄	3 ¹ / ₄	3	1 ³ / ₈	4 ¹ / ₂
1 ¹ / ₄	7 ⁷ / ₁₆	3 ⁵ / ₁₆	3 ³ / ₁₆	1 ³ / ₄	5
1 ¹ / ₂	8 ³ / ₁₆	3 ¹¹ / ₁₆	3 ³ / ₁₆	1 ¹⁵ / ₁₆	5 ⁷ / ₁₆
2	9 ⁹ / ₁₆	4 ¹ / ₄	4 ¹ / ₈	2 ⁷ / ₁₆	6 ³ / ₈

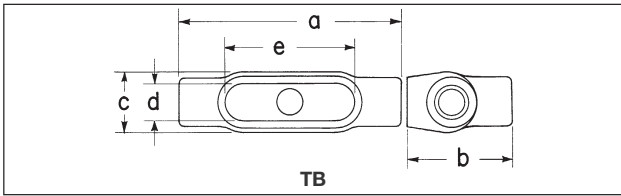

Form 7TB

Size	a	b	c	d	e
1/2	5 ⁵ / ₈	2 ⁵ / ₈	1 ⁹ / ₁₆	1 ⁵ / ₁₆	3 ³ / ₁₆
3/4	6 ¹ / ₄	2 ⁷ / ₈	1 ³ / ₄	1 ¹ / ₈	3 ¹³ / ₁₆
1	7 ¹ / ₄	3 ¹ / ₄	2	1 ³ / ₈	4 ¹ / ₂
1 ¹ / ₄	7 ⁷ / ₁₆	3 ⁵ / ₁₆	2 ³ / ₁₆	1 ³ / ₄	5
1 ¹ / ₂	8 ³ / ₁₆	5	2 ⁷ / ₁₆	1 ¹⁵ / ₁₆	5 ⁷ / ₁₆
2	9 ⁹ / ₁₆	6 ¹ / ₈	3	2 ⁷ / ₁₆	6 ³ / ₈

Form 8TB

1/2	5 ¹¹ / ₁₆	2 ¹⁷ / ₃₂	1 ³ / ₈	1	3 ⁵ / ₁₆
3/4	6 ⁹ / ₃₂	2 ³ / ₄	1 ⁹ / ₁₆	1 ³ / ₁₆	3 ¹⁵ / ₁₆
1	7 ⁵ / ₁₆	3 ¹ / ₈	1 ³ / ₄	1 ³ / ₈	4 ⁹ / ₁₆
1 ¹ / ₄	8 ¹ / ₂	3 ¹¹ / ₃₂	2 ³ / ₁₆	1 ³ / ₄	5 ⁵ / ₁₆
1 ¹ / ₂	10 ⁹ / ₁₆	4 ¹ / ₃₂	2 ³ / ₄	2 ¹ / ₈	6 ¹ / ₂
2	12 ¹ / ₄	4 ¹³ / ₁₆	3 ³ / ₄	3	8 ⁷ / ₁₆

Mark 9TB

1/2	5	2 ¹ / ₈	1 ³ / ₈	1 ³ / ₁₆	3 ⁵ / ₁₆
3/4	5 ¹¹ / ₁₆	2 ¹³ / ₃₂	1 ⁹ / ₁₆	1 ³ / ₈	3 ¹⁵ / ₁₆
1	6 ¹⁹ / ₃₂	2 ²⁷ / ₃₂	1 ³ / ₄	1 ¹ / ₂	4 ⁹ / ₁₆
1 ¹ / ₄	7 ¹ / ₂	3 ¹⁵ / ₃₂	2 ³ / ₁₆	1 ¹⁵ / ₁₆	5 ⁵ / ₁₆
1 ¹ / ₂	8 ¹¹ / ₃₂	3 ⁷ / ₈	2 ¹ / ₂	2 ⁵ / ₃₂	5 ⁷ / ₈
2	10 ⁵ / ₈	4 ¹⁹ / ₃₂	3 ⁷ / ₃₂	2 ¹⁵ / ₁₆	8 ³ / ₃₂

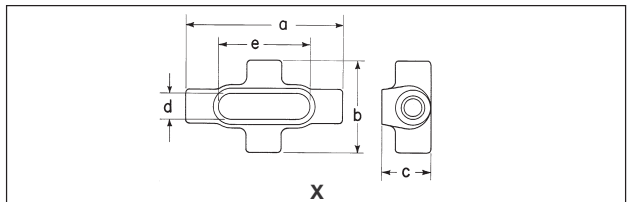

Form 7X

Size	a	b	c	d	e
1/2	5 ⁵ / ₈	3 ³ / ₁₆	1 ³ / ₄	1 ⁵ / ₁₆	3 ³ / ₁₆
3/4	6 ¹ / ₄	3 ¹ / ₂	2	1 ¹ / ₈	3 ¹³ / ₁₆
1	7 ¹ / ₄	4	2 ¹ / ₄	1 ³ / ₈	4 ¹ / ₂
1 ¹ / ₄	7 ⁷ / ₁₆	4 ¹ / ₈	2 ³ / ₁₆	1 ³ / ₄	5
1 ¹ / ₂	8 ³ / ₁₆	4 ⁵ / ₈	2 ³ / ₁₆	1 ¹⁵ / ₁₆	5 ⁷ / ₁₆
2	9 ⁹ / ₁₆	5 ³ / ₁₆	3 ¹ / ₈	2 ⁷ / ₁₆	6 ³ / ₈

Form 8X

1/2	5 ¹¹ / ₁₆	2 ²⁹ / ₃₂	1 ³ / ₄	1	3 ⁵ / ₁₆
3/4	6 ⁹ / ₃₂	3 ¹ / ₁₆	2	1 ³ / ₁₆	3 ¹⁵ / ₁₆
1	7 ⁵ / ₁₆	3 ¹ / ₂	2 ¹ / ₄	1 ³ / ₈	4 ⁹ / ₁₆
1 ¹ / ₄	8 ¹ / ₂	4 ¹ / ₈	2 ⁵ / ₈	1 ³ / ₄	5 ⁵ / ₁₆
1 ¹ / ₂	10 ⁹ / ₁₆	5 ¹ / ₄	2 ¹⁵ / ₃₂	2 ¹ / ₈	6 ¹ / ₂
2	12 ¹ / ₄	6 ¹ / ₄	3 ⁹ / ₁₆	3	8 ⁷ / ₁₆

Mark 9X

1/2	5 ¹¹ / ₁₆	2 ²⁹ / ₃₂	1 ³ / ₄	1	3 ⁵ / ₁₆
3/4	6 ⁹ / ₃₂	3 ¹ / ₁₆	2	1 ³ / ₁₆	3 ¹⁵ / ₁₆
1	7 ⁵ / ₁₆	3 ¹ / ₂	2 ¹ / ₄	1 ³ / ₈	4 ⁹ / ₁₆

Crouse-Hinds
by E.T.N

Condulet® Conduit Bodies - Cast Iron or Aluminum

1F

Mogul Bodies, Covers and Gaskets

Applications:

Mogul bodies are installed in conduit systems to:

- Act as pull outlets for conductors that are stiff, due to large size or type of insulation
- Provide the longer openings needed when pulling large conductors
- Prevent sharp bends and kinks in large conductors (protects insulation during installation)
- Provide ample openings for splices and taps
- Provide access to wiring for maintenance and future system changes

Features:

Mogul bodies have:

- Long openings
- Provision for easy bends
- Taper tapped hubs with integral bushings
- Stainless steel cover screws
- Covers are designed with integral gasket

Certifications and Complies:

- UL Standard: 514B
- Fed. Spec.: W-C-586d
- CSA Standard: C22.2 No. 18

Standard Materials:

- *Feraloy*® iron alloy

Standard Finishes:

- *Feraloy* – electrogalvanized and aluminum acrylic paint

Options:

Description

Material – copper-free aluminum
Hot dipped galvanized

Suffix
SA
HDG

BC



Mogul Series

Size	Cat. #
1	BC3
1¼	BC4
1½	BC5
2	BC6
2½	BC7
3	BC8
3½	BC9
4	BC10

BLB†



Mogul Series

Size	Cat. #
1	BLB3
1¼	BLB4
1½	BLB5
2	BLB6
2½	BLB7
3	BLB8
3½	BLB9
4	BLB10

† For 5" size use LBD012.
For 6" size use LBD014.

Dimensions

In Inches:

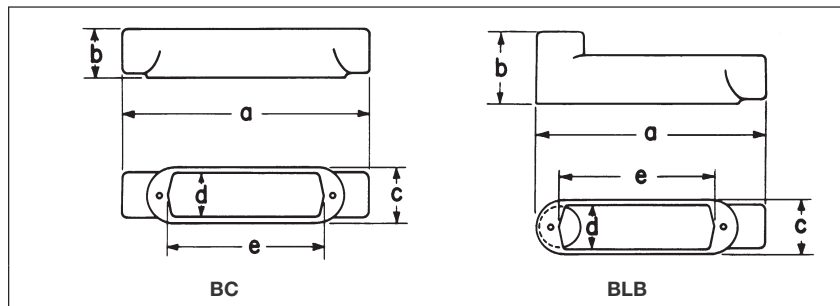

Mogul Series BC

Size	1	1¼	1½	2	2½	3	3½	4
a	9 ⁹ / ₁₆	9 ⁹ / ₁₆	13 ³ / ₄	13 ³ / ₄	18 ³ / ₈	18 ³ / ₈	23 ³ / ₄	23 ³ / ₄
b	1 ⁷ / ₈	2 ³ / ₁₆	2 ⁹ / ₁₆	3 ³ / ₈	3 ³ / ₈	4 ³ / ₈	4 ⁷ / ₈	5 ³ / ₈
c	2 ³ / ₁₆	2 ³ / ₁₆	3	3	4 ¹ / ₄	4 ¹ / ₄	5 ¹ / ₄	5 ¹ / ₄
d	1 ⁷ / ₈	1 ⁷ / ₈	2 ⁵ / ₈	2 ⁵ / ₈	3 ¹³ / ₁₆	3 ¹³ / ₁₆	4 ³ / ₄	4 ³ / ₄
e	6	6	10	10	15	15	20	20

Mogul Series BLB

Size	1	1¼	1½	2	2½	3	3½	4
a	8 ¹⁹ / ₃₂	8 ¹⁹ / ₃₂	12 ¹¹ / ₁₆	12 ¹¹ / ₁₆	16 ²⁹ / ₃₂	16 ²⁹ / ₃₂	22 ¹ / ₈	22 ¹ / ₈
b	2 ²⁷ / ₃₂	3 ⁹ / ₃₂	3 ³ / ₈	4 ³ / ₁₆	5 ²⁷ / ₃₂	5 ²⁷ / ₃₂	6 ¹ / ₂	7
c	2 ³ / ₁₆	2 ³ / ₁₆	3	3	4 ¹ / ₄	4 ¹ / ₄	5 ¹ / ₄	5 ¹ / ₄
d	1 ⁷ / ₈	1 ⁷ / ₈	2 ⁵ / ₈	2 ⁵ / ₈	3 ¹³ / ₁₆	3 ¹³ / ₁₆	4 ³ / ₄	4 ³ / ₄
e	6	6	10	10	15	15	20	20

1F Condulet® Conduit Bodies - Cast Iron or Aluminum

Mogul Bodies, Covers and Gaskets

1F

BUB



Mogul Series

Size	Cat. #
1	BUB3
1¼	BUB4
1½	BUB5
2	BUB6
2½	BUB7
3	BUB8
3½	BUB9
4	BUB10

BT

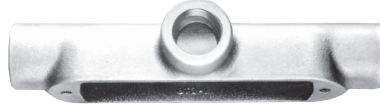

Mogul Series

Size	Cat. #
1	BT3
1¼	BT4
1½	BT5
2	BT6
2½	BT7
3	BT8
3½	BT9
4	BT10

Blank Covers



Feraloy® iron alloy (for all Mogul Series except BUBXL)

Size	With Round Neoprene Gasket Cat. #
1 or 1¼	BG48
1½ or 2	BG68
2½ or 3	BG88
3½ or 4	BG98

BUBXL with Cover & Gasket



Extra Large Mogul Series

Size	Cat. #
2	BUBXL6
3	BUBXL8

BUBXL Moguls

XL Mogul Conduit Bodies and Covers are designed to ease installation, saving time and money while maintaining the quality you have come to expect from Eaton's Crouse-Hinds.

- Larger internal volume provides additional space for bending and pulling large conductors (complies with the 6x wire bending rule)
- Rollers improve the ability to pull larger conductors and protect the insulation when the wire is being pulled, greatly reducing cut cable incidents
- Cover design takes less time to install and can be used as a solid or with the center removed for more internal volume

Dimensions In Inches:

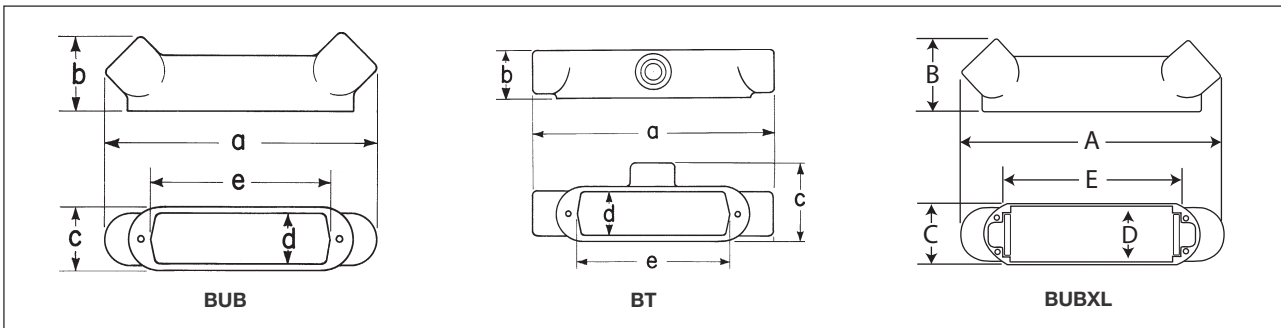

Mogul Series BUB

Size	1	1¼	1½	2	2½	3	3½	4
a	9 ⁹ / ₁₆	9 ⁹ / ₁₆	13 ³ / ₂	13 ³ / ₂	17 ³ / ₄	17 ⁷ / ₈	23 ³ / ₈	23 ³ / ₄
b	2 ¹ / ₁₆	3 ³ / ₁₆	3 ¹ / ₂	4 ¹ / ₈	4 ¹³ / ₁₆	5 ⁵ / ₈	6 ³ / ₈	6 ¹³ / ₁₆
c	2 ³ / ₁₆	2 ³ / ₁₆	3	3	4 ¹ / ₄	4 ¹ / ₄	5 ¹ / ₄	5 ¹ / ₄
d	1 ⁷ / ₈	1 ⁷ / ₈	2 ⁵ / ₈	2 ⁵ / ₈	3 ¹³ / ₁₆	3 ¹³ / ₁₆	4 ³ / ₄	4 ³ / ₄
e	6	6	10	10	15	15	20	20

Mogul Series BUBXL

Size	2	3
a	15.28	22.85
b	4.07	5.58
c	3.00	4.25
d	2.25	3.38
e	12.25	15.25

Mogul Series BT

Size	1	1¼	1½	2	2½	3	3½	4
a	9 ⁹ / ₁₆	9 ⁹ / ₁₆	13 ³ / ₄	13 ³ / ₄	18 ³ / ₈	18 ³ / ₈	23 ³ / ₄	23 ³ / ₄
b	1 ⁷ / ₈	2 ⁵ / ₁₆	2 ⁹ / ₁₆	3 ¹ / ₈	3 ⁵ / ₈	4 ³ / ₈	4 ⁷ / ₈	5 ⁵ / ₈
c	3 ³ / ₃₂	3 ⁷ / ₃₂	4 ¹ / ₁₆	4 ¹ / ₁₆	5 ¹⁹ / ₃₂	5 ²³ / ₃₂	6 ⁷ / ₈	6 ⁷ / ₈
d	1 ⁷ / ₈	1 ⁷ / ₈	2 ⁵ / ₈	2 ⁵ / ₈	3 ¹³ / ₁₆	3 ¹³ / ₁₆	4 ³ / ₄	4 ³ / ₄
e	6	6	10	10	15	15	20	20

Condulet® Conduit Bodies - Cast Iron or Aluminum

1F

LBD Mogul

Applications:

LBD bodies are installed at 90° bends in rigid conduit to:

- Act as pull outlets for conductors that are stiff due to large size or type of insulation
- Make 90° bends in conduit system, allowing straight pull in either direction
- Provide for conduit service entrance to buildings
- Provide for conductor entrance to motors
- Provide access to wiring for maintenance and future expansion

Features:

LBD bodies have:

- Cover openings on an angle permitting conductors to be pulled straight through hubs from either direction
- Domed covers to permit easy conductor bends (relieves strain on insulation)
- Cover and gasket furnished
- Taper tapped hubs with integral bushings

Certifications and Complies:

- UL Standard: 514B
- Fed. Spec.: W-C-586d
- CSA 22.2 No. 18

Standard Materials:

- Body and cover – *Feraloy*® iron alloy
- Gasket – Neoprene

Standard Finishes:

• *Feraloy* iron alloy:
1/2" to 4" sizes, electrogalvanized and aluminum acrylic paint; 5" and 6" sizes, zinc chromate primer and aluminum lacquer

- Neoprene – natural

Options:

Description

Material – All sizes, copper-free aluminum

Suffix

SA

Ordering Information



1/2 – 1"



1 1/4 – 2", 5" – 6"



2 1/2 – 4"

Size	Cat. #	Size	Cat. #	Size	Cat. #
1/2	LBD1100	1 1/4	LBD4400	3 1/2	LBD9900
3/4	LBD2200	1 1/2	LBD5500	4	LBD10900
1	LBD3300	2	LBD6600	5	LBD012
		2 1/2	LBD7700	6	LBD014
		3	LBD8800		

Replacement Gaskets for Above Sizes

Rubber

Size	Cat. #	Size	Cat. #	Size	Cat. #
1/2	GASK680R	1 1/4	GASK683R	3 1/2	GASK989R
3/4	GASK681R	1 1/2	GASK684R	4	GASK989R
1	GASK682R	2	GASK684R	5	GASK687R
		2 1/2	GASK990R	6	GASK688R
		3	GASK990R		

Replacement Cover Assembly with Hardware

Size	Cat. #	Size	Cat. #	Size	Cat. #
1/2	LBD100	1 1/4	LBD400	3	LBD800
3/4	LBD200	1 1/2	LBD600	3 1/2	LBD900
1	LBD300	2	LBD600	4	LBD900
		2 1/2	LBD800	5	LBD120
				6	LBD140

Dimensions

In Inches:

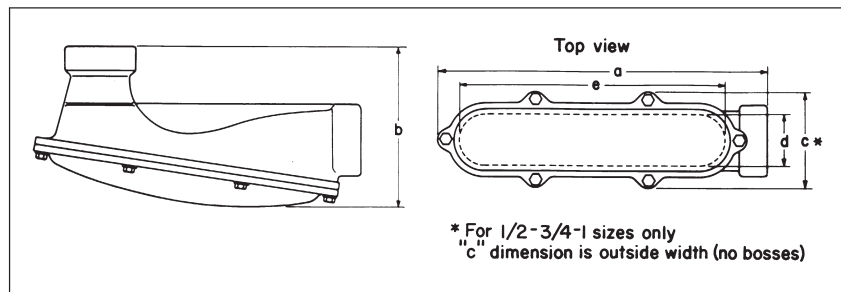

Cat. #	Size	a	b	c	d	e
LBD1100	1/2	5	2 5/16	1 5/16	1	3 11/32
LBD2200	3/4	6 1/4	2 5/8	1 9/16	1 1/4	4 17/32
LBD3300	1	6 1/4	2 15/16	1 13/16	1 1/2	4 11/32
LBD4400	1 1/4	8 5/8	4 1/4	3 1/2	1 13/16	7 7/16
LBD5500	1 1/2	12 7/16	5 7/16	4 3/8	2 5/8	10 7/8
LBD6600	2	12 7/16	5 7/16	4 3/8	2 5/8	10 7/8
LBD7700	2 1/2	19 11/16	9 3/16	5 5/8	3	15 3/4
LBD8800	3	19 11/16	9 3/16	5 5/8	3	15 3/4
LBD9900 (iron)	3 1/2	20 7/8	10 7/8	7 3/4	4 3/4	19 7/8
LBD10900 (iron)	4	20 7/8	10 7/8	7 3/4	4 3/4	19 7/8
LBD9900 (-SA)	3 1/2	27 13/16	11 7/8	7 1/8	4	24
LBD10900 (-SA)	4	27 13/16	11 7/8	7 1/8	4	24
LBD012	5	32 1/16	12 1/2	8 5/8	5 7/8	30
LBD014	6	41 1/2	15	9 3/4	7	39

1F Condulet® Conduit Bodies - Cast Iron or Aluminum

Weather Resistant

Mogul Pulling Elbows

1F

Applications:

Die cast mogul pulling elbows are installed in conduit systems to provide:

- An accessible weather resistant chamber for containing heavy duty conductors
- A chamber for containing 90° turn in large stiff conductors. Used either to change conductor direction or to enter buildings
- A pull box for pulling large conductors
- A chamber for making splices and taps
- An accessible opening to accommodate future changes of the system

Features:

- Large dome cover permits easy, straight through pull
- Dimension from centerline of back hub to bushing of end hub exceeds six times the trade diameter of the conduit
- Tapered threads provide easy assembly, tight construction
- Heavy duty machine screws for cover
- Cover is gasketed
- Smooth design and finish make handling easy and complement any construction job

Certifications and Compliances:

- UL Standard: 514A
- NEC: Article 314
- CSA C22.2 No. 18
- CEC: 22.1

Standard Materials:

- Die cast copper-free aluminum

Standard Finishes:

- Aluminum lacquer

LBNEC Furnished With Cover, Gasket and Screws

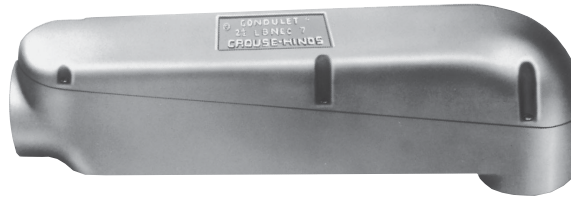

Size	Cat. #	Bending Radius
2½	LBNEC7	5¼
3	LBNEC8	5¾
3½	LBNEC9	7
4	LBNEC10	7⅝

Dimensions

In Inches:

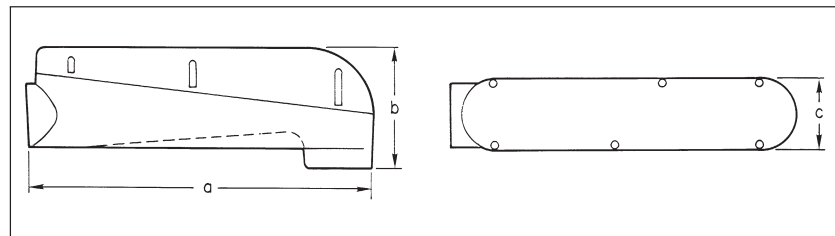

Cat. #	Size	a	b	c
LBNEC7	2½	21 ¹¹ / ₁₆	8 ⁹ / ₃₂	4½
LBNEC8	3	21 ¹¹ / ₁₆	8 ⁹ / ₃₂	4½
LBNEC9	3½	28 ¹¹ / ₁₆	9 ⁷ / ₃₂	5½
LBNEC10	4	28 ¹¹ / ₁₆	9 ⁷ / ₃₂	5½

Condulet® Conduit Outlet Bodies, Covers and Gaskets - Stainless Steel



Eaton's Crouse-Hinds Condulet® Stainless Steel Fittings deliver power where you need it, saving you time and money throughout the life of your facility.

Superior resistance to corrosion and heat, combined with unmatched strength, make stainless steel Condulet bodies and boxes a long-term solution for even the most extreme environments.

Applications:

Conduit outlet bodies are installed in conduit systems to:

- Act as pull outlets for conductors being installed
- Provide openings for making splices and taps in conductors
- Act as mounting outlets for lighting fixtures and wiring devices
- Connect conduit sections
- Provide taps for branch conduit runs
- Make 90° bends in conduit runs
- Provide for access to conductors for maintenance and future system changes

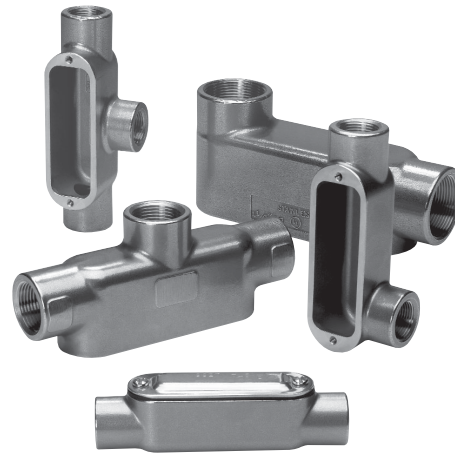

Features:

- Self-healing properties of stainless steel fittings help reduce the penetration of rust/corrosion and eliminate damage to the fitting
- Stainless steel fittings retain their strength in extreme heat and extreme cold conditions
- Fitting surface is easy to maintain and keep clean
- Easy cleaning capabilities make these fittings perfect for food processing and other hygienic areas where wash downs are common
- Superior strength and durability greatly reduce replacement of fittings - this will lower your total cost of ownership and increase your return on investment
- Stainless steel fittings do not require harsh environment-damaging cleaners to keep them looking like new
- Conduit hubs have tapered threads and feature integral bushing for protection of wire insulation
- Outlet bodies designed to match conduit size for neat, compact installations

Dimension

A	Overall length
B	Overall height
C	Overall width
D	Width of opening
E	Length of opening

Certifications and Compliances:

- UL Standard 514A
- CSA Standard C22.2 No. 18.1-04
- Raintight - when installed with cover and gasket

Standard Materials:

- Bodies - 316 stainless steel
- Covers - 316 stainless steel
- Cover Screws - 316 stainless steel
- Gasket - neoprene

1F Condulet® Conduit Outlet Bodies, Covers and Gaskets - Stainless Steel

1F

Ordering Information - conduit body supplied with cover and gasket

T Conduit Body, Cover and Gasket



Catalog Number	Trade Size	A	B	C	D	E
T18SS	1/2"	5.56	1.75	1.31	1.02	3.15
T28SS	3/4"	6.61	2.00	1.63	1.27	3.92
T38SS	1"	7.53	2.31	1.78	1.42	4.61
T48SS	1 1/4"	8.75	2.50	2.25	1.83	5.50
T58SS	1 1/2"	9.37	2.75	2.47	2.03	6.12
T68SS	2"	11.50	3.38	3.13	2.50	8.00
T88SS	3"	15.00	4.63	4.34	3.71	10.25
T108SS	4"	18.25	5.44	5.50	4.87	13.00

LB Conduit Body, Cover and Gasket



Catalog Number	Trade Size	A	B	C	D	E
LB18SS	1/2"	4.86	1.35	1.31	1.02	3.15
LB28SS	3/4"	5.75	1.63	1.63	1.27	3.94
LB38SS	1"	6.48	2.00	1.78	1.42	4.55
LB48SS	1 1/4"	7.75	3.50	2.25	1.83	5.50
LB58SS	1 1/2"	8.38	2.75	2.47	2.03	6.13
LB68SS	2"	10.50	3.38	3.13	2.50	8.00
LB88SS	3"	13.50	6.13	4.34	3.71	10.25
LB108SS	4"	16.63	7.25	5.50	4.87	13.00

TB Conduit Body, Cover and Gasket



Catalog Number	Trade Size	A	B	C	D	E
TB28SS	3/4"	6.61	2.88	1.63	1.27	3.95
TB38SS	1"	7.53	3.23	1.78	1.42	4.61
TB48SS	1 1/4"	8.75	3.50	2.25	1.83	5.50
TB58SS	1 1/2"	9.37	3.75	2.47	2.03	6.12
TB68SS	2"	11.50	4.38	3.13	2.50	8.00

C Conduit Body, Cover and Gasket

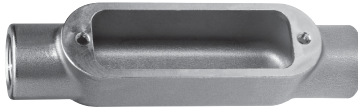

Catalog Number	Trade Size	A	B	C	D	E
C18SS	1/2"	5.56	1.38	1.31	1.02	3.15
C28SS	3/4"	6.56	1.63	1.63	1.27	3.94
C38SS	1"	7.50	2.00	1.78	1.42	4.61

LL Conduit Body, Cover and Gasket



Catalog Number	Trade Size	A	B	C	D	E
LL28SS	3/4"	5.72	1.63	1.63	1.27	3.95
LL38SS	1"	6.59	2.00	1.78	1.42	4.61

LR Conduit Body, Cover and Gasket

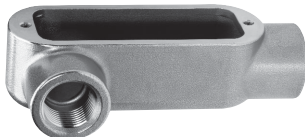

Catalog Number	Trade Size	A	B	C	D	E
LR28SS	3/4"	5.72	1.63	1.63	1.27	3.95
LR38SS	1"	6.59	2.00	1.78	1.42	4.61

Condulet® Outlet Boxes - Cast Iron or Aluminum

1F

Covers and Gaskets

Applications:

VXF and GRF cast outlet boxes are installed in threaded rigid conduit systems to:

- Act as junction boxes
- Act as pull outlets
- Accept round base wiring devices and covers intended for use on 4" outlet boxes (GRF boxes only)
- Act as ceiling or wall mounting for *Vaporgard™* lighting fixtures (VXF boxes)
- Mount enclosed and gasketed lighting fixtures: Series ARB and VGR; Series ARB fixture hangers (GRF boxes)

Features VXF:

- Compact, shallow design
- Takes GRF covers
- Multiple tapped conduit openings and pipe plugs for versatility
- 4 hubs and 3 plugs on VXF10 and VXF20
- 5 hubs and 4 plugs on VXFT10 and VXFT20

Features GRF:

- Surface mounting. Flush mounting can be obtained by nailing box to concrete form through mounting lug
- Drilled mounting lugs
- Four conduit bosses spaced 90° apart on sides and one boss on back
- Blank or drilled and tapped bodies (with 4 side bosses tapped and plugged, plus blank back boss)

Certifications and Compliances:

- UL Standard: boxes and covers – 514A
- CSA Standard: C22.2

Standard Materials:

- VXF – copper-free aluminum
- GRF – *Feraloy®* iron alloy or copper-free aluminum

Standard Finishes:

- VXF – epoxy enamel
- GRF – electrogalvanized and aluminum acrylic paint

Options:

Description
GRF bodies and covers - hot dipped galvanized

Suffix
HDG

VXF Tapped Surface With Lugs



4 Hubs, 3 Plugs

Hub Size	Cat. #
1/2	VXF10
3/4	VXF20

Surface With Lugs

Hub Size	Cat. #
1/2	VXFT10
3/4	VXFT20

GRF Blank Surface With Lugs



Inside Depth	Cat. #
1 3/8	GRF19
1 15/16	GRF29
3 1/8	GRF39

GRFX Tapped Surface With Lugs



4 Hubs, 3 Plugs Blank Back Boss

Inside Depth	Size Tap	Iron Cat. #	Aluminum Cat. #
1 3/8	1/2	GRFX119	GRF119
1 3/8	3/4	GRFX219	GRF219
2 1/16	1/2	GRFX129	GRF129
2 1/16	3/4	GRFX229	GRF229
2 1/16	1	GRFX329	GRF329
3 1/8	1/2	GRFX139	GRF139
3 1/8	3/4	GRFX239	GRF239
3 1/8	1	GRFX339	GRF339

Dimensions In Inches:

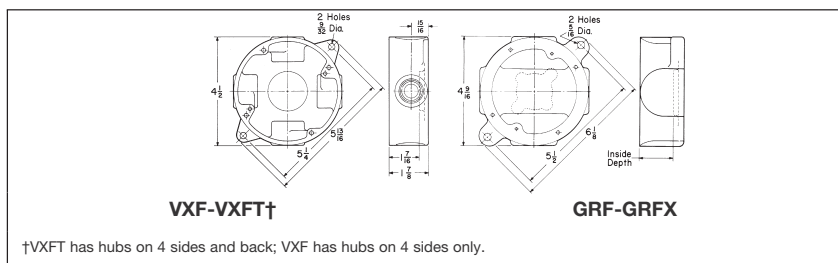

See lighting section 7L for complete listing of lighting fixtures and hangers.

GRF Blank Cover



Description	Iron Cat. #	Aluminum Cat. #
Surface	GRF10	GRF110

GRF Hub Covers



Fixture weight to 125 lbs.

Description	Size	Iron Cat. #	Aluminum Cat. #
Surface	1/2	GRF11	GRF11 SA
Surface	3/4	GRF12	GRF12 SA

GRF Gasket



Description	Cat. #
Neoprene	GASK643

1F Condulet® Service Entrance Elbows and Tees

1F

Applications:

- SLB and LBY elbows are installed in conduit systems to:
- Act as service entrance elbows between service entrance and vertical weatherhead conduit runs
 - Make 90° bends in conduit systems where space is limited
 - Act as pull outlets
 - Provide access to conductors for maintenance and future system changes

ET short radius tees are installed in conduit systems:

- In concealed conduit runs allowing single conduit stub up to outlet boxes located above or below main conduit run. Eliminates separate feed and return conduits to flush floor box or junction box

Features:

SLB elbows have:

- Compact overall size and short hubs
- Taper tapped hubs and integral bushing for standard threaded conduit
- Covers and gaskets furnished

LBY elbows have:

- Maximum volume for bends within a compact overall size
- Screw-on cover for ease of installation and removal
- Cover openings on an angle, permitting conductors to be pulled straight through either hub
- Taper tapped hubs and integral bushing for standard threaded conduit

ET short radius tees have:

- Compact size, small radius of bend for use in concealed or open conduit systems. Particularly suited for use in shallow floors or partitions
- Taper tapped hubs and integral bushing for standard threaded conduit

Certifications and Compliances:

- UL Standard: 514B
- Fed. Spec.: W-C-586a

Standard Materials:

- SLB elbows – copper-free aluminum
- LBY elbows – *Feraloy*® iron alloy
- ET tees – *Feraloy* iron alloy

Standard Finishes:

- Copper-free aluminum – natural
- Feraloy* iron alloy – electrogalvanized and aluminum acrylic paint

Options:

Description

Finishes – LBY elbows:

Corro-free™ epoxy power coat
Material (LBY only) – copper-free aluminum construction

SLB (includes cover)



Size	Cat. #
1/2	SLB1
3/4	SLB2
1	SLB3
1 1/4	SLB4
1 1/2	SLB5
2	SLB6

Suffix

S752
SA

LBY (includes cover)



Size	Cat. #
1/2	LBY15
3/4	LBY25
1	LBY35
1 1/4	LBY45
1 1/2	LBY55

ET



Size	Cat. #
3/4 – 1/2 – 1/2	ET218
3/4 – 3/4 – 3/4	ET228
1 – 3/4 – 3/4	ET328

Largest hub shown at top of photo

Dimensions In Inches:

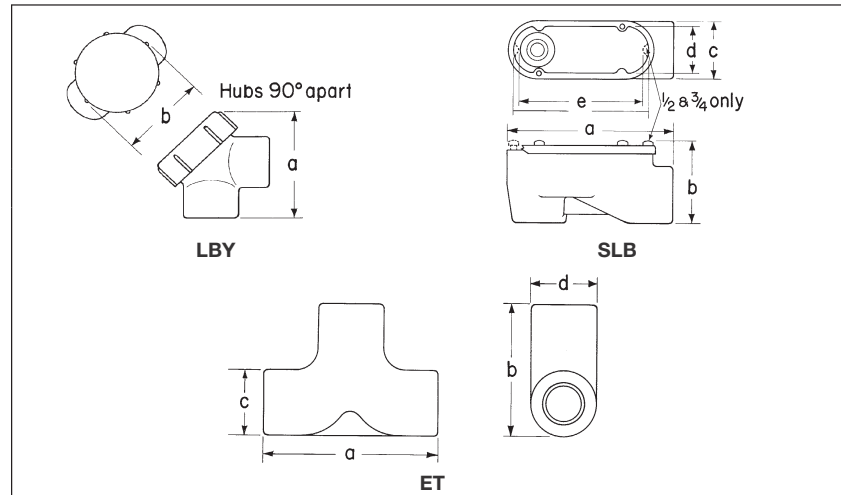

SLB

Size	1/2	3/4	1	1 1/4	1 1/2	2
a	3 1/8	3 1/2	4 1/8	5 3/8	6 25/32	7 3/4
b	1 25/32	2	19/32	2 25/32	3 1/32	3 29/32
c	1 3/16	1 3/8	1 11/16	2 3/32	2 9/8	3
d	1	1 3/16	1 15/32	1 7/8	2 5/32	2 5/8
e	2 11/16	2 15/16	3 11/32	4 3/4	6 1/32	6 31/32

LBY

Size	1/2	3/4	1	1 1/4	1 1/2
a	2 13/16	3 7/16	3 1/4	3 25/32	4 1/2
b	2	2 1/4	2 1/2	2 15/16	3 3/8

ET

Size	3/4 – 1/2 – 1/2	3/4 – 3/4 – 3/4	1 – 3/4 – 3/4
a	4	4	4
b	2 5/8	3	3
c	1 1/4	1 1/2	1 1/2
d	1 1/2	1 1/2	1 3/4



Description	Page No.
Application/Selection	see page 22
Shape Selector Charts	see page 23
Device Boxes - Cast Iron or Aluminum	
FS/FD Series	
Single gang	
Blank	see pages 31–34
Cast hubs	see pages 25–28
Multi-gang	
Blank	see pages 31–34
Cast hubs	see pages 29–30
Covers for Cast Iron or Aluminum Device Boxes	
WLR and WLG Wet Locations Covers For NEMA Configuration and GFCI Receptacles	
Blank	see page 39
Pilot light	see page 43
Push button	see page 41
Receptacle	see page 37
Switch	see page 39
Device Boxes and Covers - Stainless Steel	
FS/FD Series	see pages 35–36
Plugs and Receptacles	
DS Series	see page 42
DS/WP Series	see page 42
FSE Series	see page 46

2F Condulet® Cast Device Boxes and Covers

Application and Selection

2F

Applications:

Cast device boxes are installed in conduit and cable systems to:

- Accommodate wiring devices
- Act as pull boxes for conductors in a conduit system
- Provide openings to make splices and taps in conductors
- Provide access to conductors for maintenance and future system changes

Considerations for Selection of Device Box

Type of conduit system:

- Should be compatible with conduit or cable system.
- Boxes are standard with mounting lugs and internal green ground screw.
- Boxes are available for rigid steel, IMC; rigid aluminum; flexible conduit and cable systems.

Number of devices to be used in the box:

- Standard flush devices require one gang each

Depth:

- Two box types are available – standard (FS) and deep (FD), single through five gang.
- Standard flush wiring devices will normally fit in the FS boxes.
- Some special purpose devices of higher ratings will require the deeper box (FD).
- In addition, the need for additional wiring space will require the deep box.

Hub configuration and size:

- The layout of the conduit system dictates the conduit opening locations of the box.

The table below indicates the types of conduit and the boxes available. Drilled and tapped openings can be supplied in blank boxes to meet your requirements.

- Hub size is the same as conduit size. A variety of hub sizes are available. Where the specific hub size is not available, reducing bushings can be used.

Materials and finishes:

- The environment and the use of the box will determine the material and finish needed. Areas of the country with harsh weather and corrosive environments may require different materials and finishes for added protection.
- Standard material and finish is Feraloy® iron alloy with electrogalvanized and aluminum acrylic paint. Many items are also available in copper-free aluminum.
- Optional finishes can be obtained if environment warrants. See Options listings.

Quick Selector Chart

Box	Depth	Gang	Conduit Type	Standard Material	Standard Finish
FS	1 ¹¹ / ₁₆	1-3	Threaded rigid	Feraloy iron alloy (some are copper-free aluminum)	Feraloy iron alloy – electrogalvanized and aluminum acrylic paint. Copper-free aluminum – natural
FD	2 ¹ / ₂	1-3	Threaded rigid	Feraloy iron alloy	Feraloy iron alloy – electrogalvanized and aluminum acrylic paint
FD-SS	3.03	1	Threaded rigid	Stainless steel	Natural
FS blank bodies Drilled and tapped	1 ¹⁵ / ₁₆	1-4 1-3	Threaded rigid	Feraloy iron alloy	Feraloy iron alloy – electrogalvanized and aluminum acrylic paint
FD blank bodies Drilled & tapped	2 ¹ / ₂	1-5 1-3	Threaded rigid	Feraloy iron alloy	Feraloy iron alloy – electrogalvanized and aluminum acrylic paint

Considerations for Selection of Covers, Devices, and Accessories

Both general purpose and weatherproof, waterproof devices and covers are available. Selection will depend on individual conditions. To provide for a wide variety of applications, the following covers and devices are available:

Covers

- General use snap switch
- Pushbutton switch
- Plug and receptacle
- Blank
- Pilot light
- Receptacle

Pg.

- see pages 39–41 and 44–45
- see page 41
- see pages 37, 39, 42, and 44–46
- see pages 39 and 44–45
- see page 43
- see pages 37–39, 42, and 44–46

Devices

- Receptacle
- Pilot lights
- Wiring device

Pg.

- see page 42
- see page 43
- see page 42

Accessories

- Gaskets
- Box extensions
- Flush mtg. adapter

Pg.

- see page 43
- see page 43
- see page 43

Options:

Description

Corro-free™ epoxy powder coat

Suffix

S752

Single Gang Shape Selector Chart

Series Page

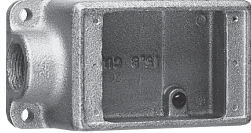

FS/FD see pages 25–26
 FS (Double face) see pages 25–28
 FS-SA see pages 25–26

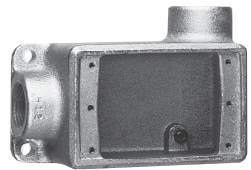

FSR/FDR see pages 25–26

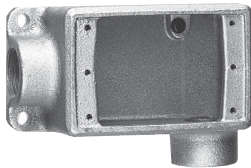

FSL/FDL see pages 25–26

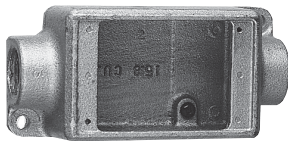

FSC see pages 25–26
 FDC see pages 25–26
 FSC (Double face) see pages 25–28
 FSC-SA see pages 25–26

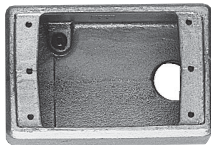

FSA/FDA see pages 25–26

Series Page

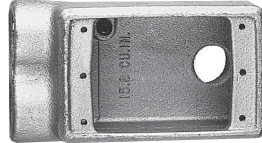

FSSA see pages 25–26

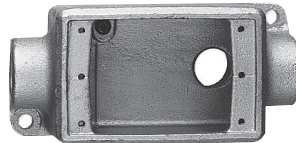

FSCA see pages 25–26

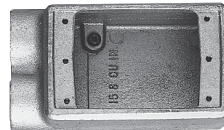

FSS see pages 25–26
 FDD see pages 25–26

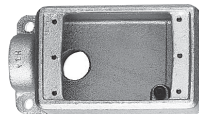

FSLA/FDLA see pages 25–26

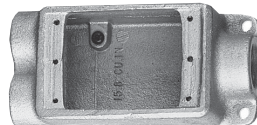

FSCC/FDCC see pages 25–26

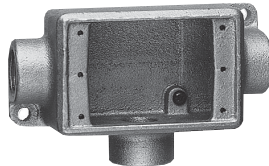

FSCT/FDCT see pages 27–28

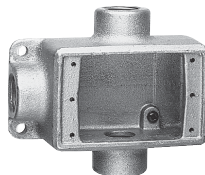

FST/FDT see pages 27–28

Series Page



FSY (With flange) see pages 27–28

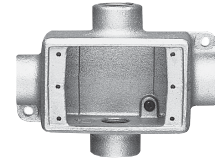

FSX/FDX see pages 27–28

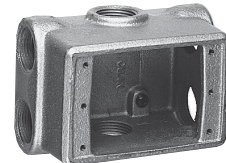

FDXC see pages 27–28

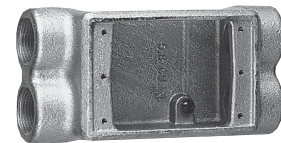

FSCD see pages 27–28



FD Stainless Steel see pages 35–36



2F

If the hub configurations required are not available, drilled and tapped openings can be provided in blank boxes per your specifications. See pages 31–34 for details.

2F Condulet® Cast Device Boxes with Hubs

Multi-Gang Shape Selector Chart

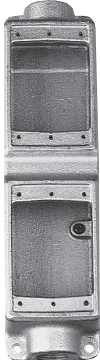
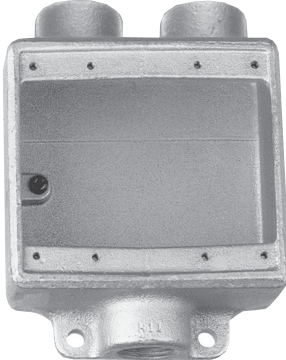
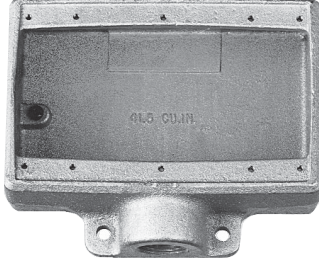
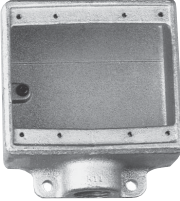
2F

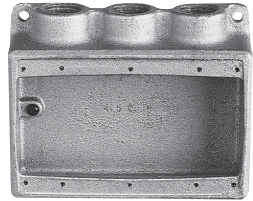
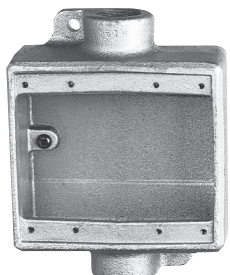
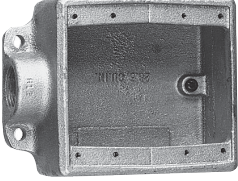
Series	Page	Series	Page	Series	Page
	see pages 29–30		see pages 29–30		see pages 29–30
FSC (Two gang tandem)		FSD (Two gang)		FS/FD (Three gang)	
	see pages 29–30		see pages 29–30		see pages 29–30
FS/FD (Two gang)		FSS/FDS (Two gang)		FSS (Three gang)	
	see pages 29–30		see pages 29–30		
FSC/FDC (Two gang)		FSE (Two gang)			

If the hub configurations required are not available, drilled and tapped openings can be provided in blank boxes per your specifications. See pages 31–34 for details.

Condulet® Single Gang Device Boxes - Cast Iron or Aluminum

Accessories
see pages 37–45

2F

With and Without Mounting Lugs for Threaded Rigid and IMC Conduit

Applications:

- Cast device boxes are installed to:
- Accommodate wiring devices
 - Act as pull boxes for conductors in a conduit system
 - Provide openings to make splices and taps in conductors
 - Provide access to conductors for maintenance and future system changes
 - Connect conduit sections
 - FSY boxes for mounting surface devices on floor or bench (used with single gang covers)

Features:

- Internal green ground screw standard on boxes
- Suitable for use in wet locations when used with gasketed covers
- Mounting lugs standard on most boxes
- Tapered threaded hubs (NPT) with integral bushing
- Available for surface mounting (with mounting lugs) or flush mounting (without mounting lugs) as listed
- Available as shallow (FS) or deep (FD) configuration. Use FD if device to be enclosed exceeds 1 5/8" in depth
- Ample wiring room provided in either FS or FD configuration
- Wide selection of surface or flush covers available in three materials (sheet steel, *Feraloy*®, aluminum)
- Covers for flush mounting extend to conceal the rough plaster line
- Available in single gang and multi-gang configurations with hubs, and as blank bodies for drilled and tapped openings

Certifications and Compliances:

- UL Standard: 514
- ANSI Standard: C33.84
- Fed. Spec.: W-C-5860
- CSA Standard: C22.2 No. 18

Standard Materials:

- *Feraloy* iron alloy or copper-free aluminum.

Standard Finishes:

- *Feraloy* – electrogalvanized and aluminum acrylic paint
- Aluminum – natural

Options:

Description	Suffix
Finishes: <i>Corro-free</i> ™ epoxy powder coat - external body	S752
<i>Corro-free</i> ™ epoxy powder coat - internal and external	S753
Hot dipped galvanized	HDG

Size Ranges:

- Hubs – 1/2" to 1"

FS & FD

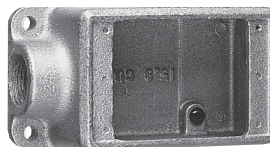

Size	Cat. #	Cat. #
1/2	FS1*	FD1†
3/4	FS2*	FD2†
1	FS3†	FD3†

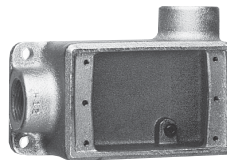

Size	Cat. #	Cat. #
1/2	FSR1	FDR1
3/4	FSR2	FDR2*†

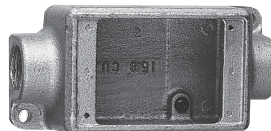

Size	Cat. #	Cat. #
1/2	FSC1*	FDC1†
3/4	FSC2*	FDC2†
1	FSC3†	FDC3†

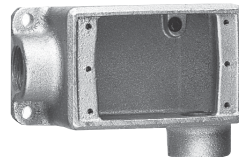

Size	Cat. #	Cat. #
1/2	FSL1	FDL1
3/4	FSL2	FDL2*†

*Available in sand cast copper-free aluminum – add suffix SCA to Cat. No.
†Available in sand cast copper-free aluminum – add suffix SA to Cat. No.

Die Cast Aluminum‡

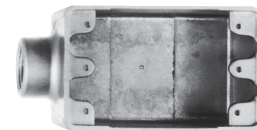

Size	Cat. #	Cat. #
1/2	FS1 SA	FSC1 SA
3/4	FS2 SA	FSC2 SA

‡Mounting lugs and ground screw are not offered with standard die cast aluminum box. For sand cast aluminum box with mounting lugs and ground screw, change "SA" in catalog number to "SCA" (Example: FS1 SCA).

Condulet® Single Gang Device Boxes - Cast Iron or Aluminum

Accessories
see pages 37-45

With and Without Mounting Lugs for
Threaded Rigid and IMC Conduit

2F

FS & FD

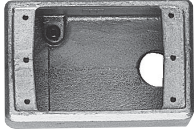

Size	Cat. #†	Cat. #†
1/2	FSA1	FDA1
3/4	FSA2	FDA2

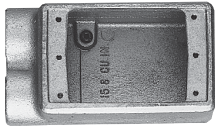

Size	Cat. #†	Cat. #†
1/2	FSS1*	FDD1
3/4	FSS2*	FDD2*
1	FSS3	FDD3

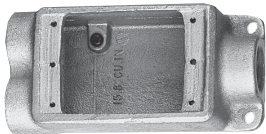

Size	Cat. #	Cat. #
1/2	FSCC1	FDCC1
3/4	FSCC2	FDCC2

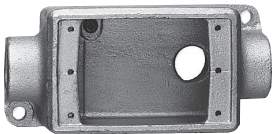

Size	Cat. #
1/2	FSCA1
3/4	FSCA2

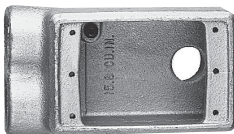

Size	Cat. #†
3/4	FSSA2

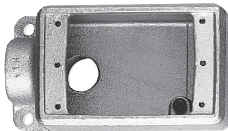

Size	Cat. #	Cat. #
1/2	FSLA1	FDLA1
3/4	FSLA2	FDLA2

*Available in copper-free aluminum; add suffix "SA".
†Mounting lugs not available.

Dimensions

In Inches:

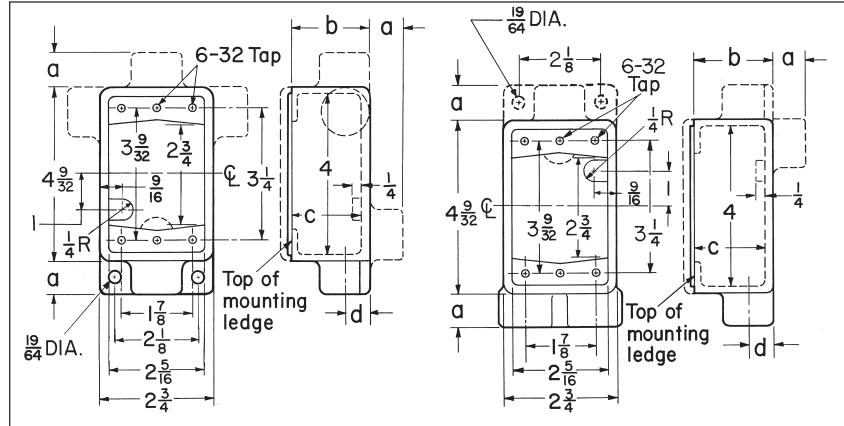

Series	Hub Size	a	b	c	d
FS	1/2	7/8	1 7/8	1 11/16	5/8
	3/4	7/8	1 7/8	1 11/16	3/4
	1	1	1 7/8	1 11/16	7/8
FD	1/2	7/8	2 11/16	2 1/2	5/8
	3/4	7/8	2 11/16	2 1/2	3/4
	1	1	2 11/16	2 1/2	7/8

Condulet® Single Gang Device Boxes - Cast Iron or Aluminum

Accessories
see pages 37-45

2F

With and Without Mounting Lugs for
Threaded Rigid and IMC Conduit

FS & FD

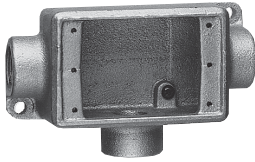

Size	Cat. #	Cat. #
1/2	FSCT1	FDCT1
3/4	FSCT2*	FDCT2*
1	FSCT3	FDCT3

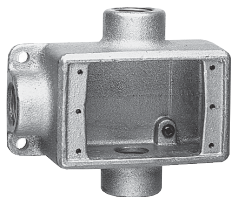

Size	Cat. #	Cat. #
1/2	FST1*	FDT1
3/4	FST2*	FDT2
1		FDT3

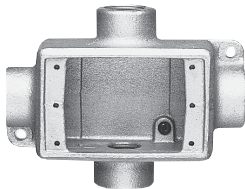

Size	Cat. #	Cat. #
1/2	FSX1	FDX1
3/4	FSX2	FDX2
1		FDX3

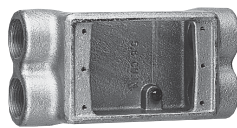

Size	Cat. #†
1/2	FSCD1
3/4	FSCD2

*Available in copper-free aluminum; add suffix "SA".
†6 Hubs - all 3/4" pipe tap.
‡ Not available with mounting lugs.

FSY



Description	Hub Size	Cat. # ‡
Single face	1	FSY311
Double face	1	FSY312

Dimensions

In Inches:

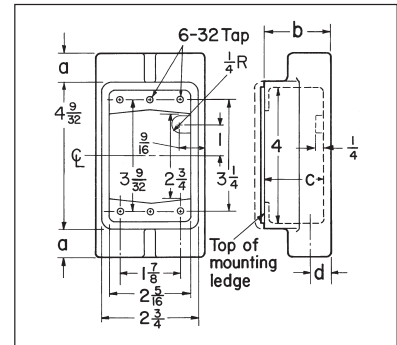
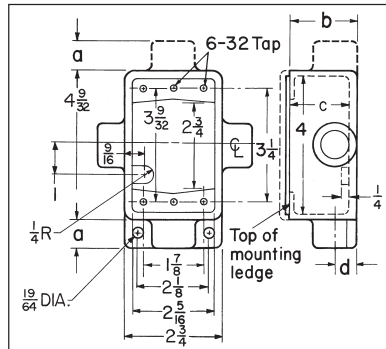

FSCT, FSX, FST, FSCD

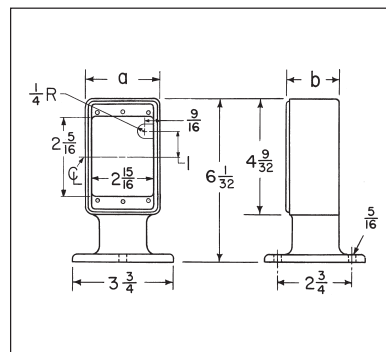

FSY

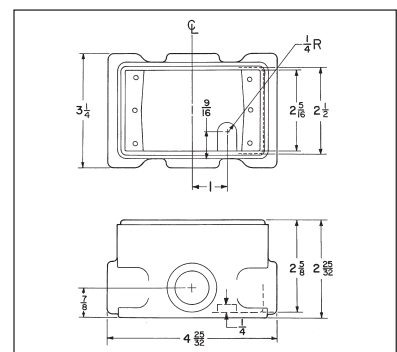

FDXC

FSCT, FSX, FST, FSCD

Series	Hub Size	a	b	c	d
FS	1/2	7/8	1 7/8	1 11/16	5/8
	3/4	7/8	1 7/8	1 11/16	3/4
	1	1	1 7/8	1 11/16	7/8

FSY

Description	Hub Size	a	b
Single gang, single face	1	2 3/4	1 15/16
Single gang, double face	1	2 3/4	3 3/8

2F Condulet® Single Gang Device Boxes - Cast Iron or Aluminum

Accessories
see pages 37-45

With and Without Mounting Lugs

2F

FS

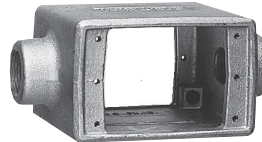

Double Face

Size	Cat. #†
1/2	FS152
3/4	FS252

Double Face

Size	Cat. #†
1/2	FSC152
3/4	FSC252

†Mounting lugs not available.

Dimensions

In Inches:

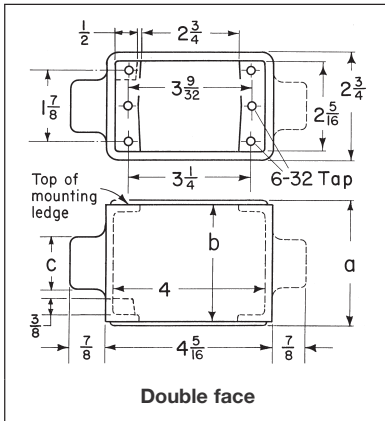

Series	Hub Size	a	b	c
FS	1/2	3 5/16	3 1/8	1 1/4
	3/4	3 11/16	3 1/2	1 1/2

Condulet® Multi-Gang Device Boxes - Cast Iron or Aluminum

Accessories
see pages 37-45

2F

With and Without Mounting Lugs for
Threaded Rigid and IMC Conduit

FS†

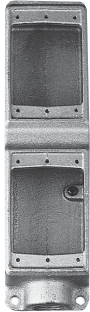

Two Gang Tandem

Size	Cat. #
1/2	FS17
3/4	FS27

FSC†



Two Gang Tandem

Size	Cat. #
1/2	FSC17
3/4	FSC27

FSE

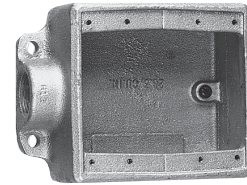

Two Gang

Size	Cat. #
3/4	FSE22

FS & FD

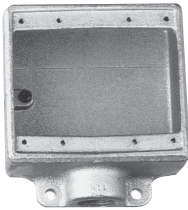

Two Gang

Size	Cat. #	Cat. #
1/2	FS12*	FD12
3/4	FS22*	FD22*
1	FS32	FD32

FSC & FDC

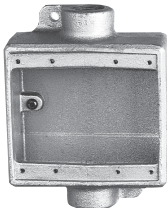

Two Gang

Size	Cat. #	Cat. #
1/2	FSC12	FDC12
3/4	FSC222	FDC222*
1	FSC32	FDC32

†Use single gang covers only.

*Available in copper-free aluminum;
add suffix "SA".

Dimensions

In Inches:

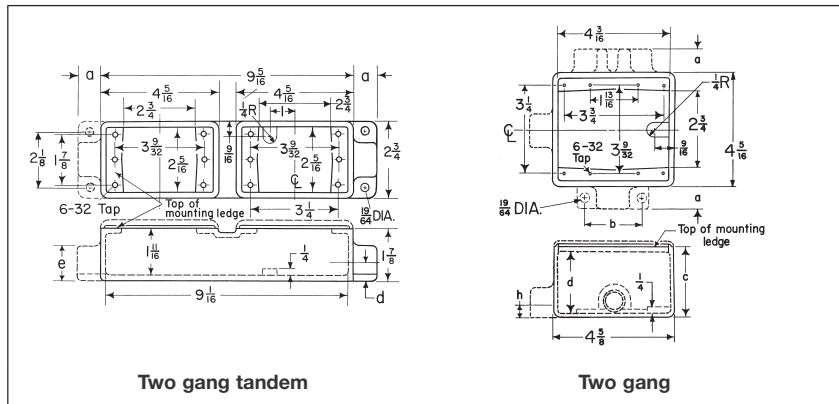

Two gang tandem

Series	Hub Size	a	b	e
FS	1/2	7/8	5/8	1 1/4
	3/4	7/8	3/4	1 1/2

Two gang

Series	Hub Size	a	b	c	d	h
FS	1/2	7/8	2 1/4	1 7/8	1 11/16	5/8
	3/4	7/8	2 1/4	1 7/8	1 11/16	3/4
	1	1	2 1/2	1 7/8	1 11/16	7/8
FD	1/2	7/8	2 1/4	2 11/16	2 1/2	5/8
	3/4	7/8	2 1/4	2 11/16	2 1/2	3/4
	1	1	2 1/2	2 11/16	2 1/2	7/8

2F Condulet® Multi-Gang Device Boxes - Cast Iron or Aluminum

Accessories
see pages 37-45

With and Without Mounting Lugs for
Threaded Rigid and IMC Conduit

2F

FSS & FDS



Two Gang

Size	Cat. #	Cat. #
3/4	FSS222	FDS222

FSD

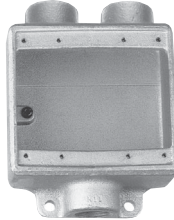

Two Gang

Size	Cat. #
3/4	FSD212*

*Hubs on 2 hub side are 1/2"

FS & FD

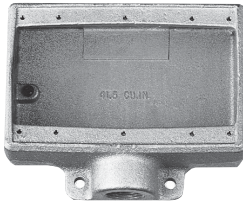

Three Gang

Size	Cat. #	Cat. #
3/4	FS23	FD23
1	FS33	

FSS

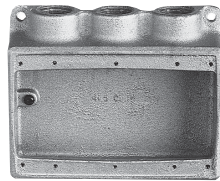

Three Gang

Size	Cat. #
3/4	FSS23

Dimensions

In Inches:

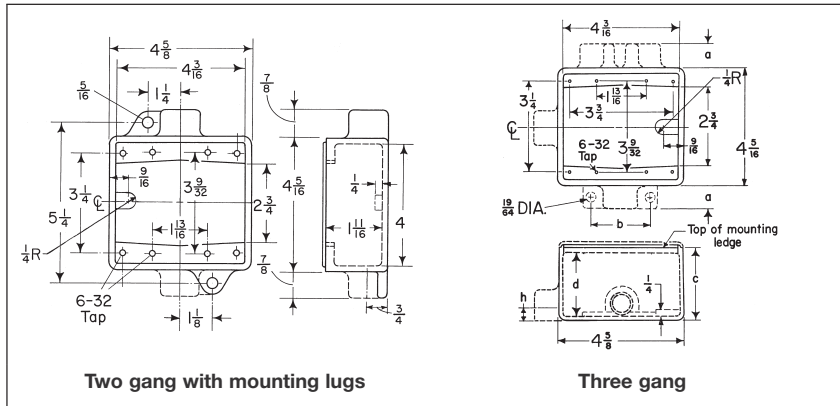

Three gang

Series	Hub Size	a	c	d
FS	3/4	7/8	1 7/8	1 11/16
	1	1	1 7/8	1 11/16
FD	3/4	7/8	2 11/16	2 1/2

Blank Bodies With Mounting Lugs for Drilling and Tapping Single Gang, Multi-Gang, Tandem

Applications:

Blank cast device boxes are used:

- Where several wiring devices are to be grouped together
- To assemble special combinations of wiring devices
- Where special arrangements of conduit hubs or entrances are required

Features:

- Available in shallow (FS) or deep (FD) configurations.
- FS/FD bodies have thick walls for drilling and tapping conduit entrances.
- Internal green ground screw standard on boxes.
- Available in single, two, three, four and five gang and two gang tandem bodies.
- Cast mounting lugs at diagonally opposite corners.
- For a wide selection of standard surface or flush covers see pages 37–45.

Certifications and Compliances:

- UL Standard: 514A
- CSA Standard: C22.2 No. 18

Standard Materials:

- *Feraloy* iron alloy

Standard Finishes:

- *Feraloy* – electrogalvanized and aluminum acrylic paint



FS019, FD019 single gang



FS062, FD062 two gang

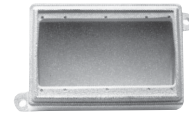

FS063, FD063 three gang

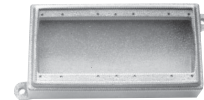

FS094, FD094 four gang

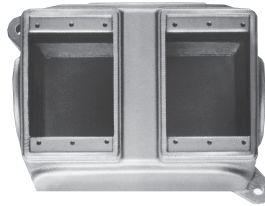

FS029, FD029 two gang

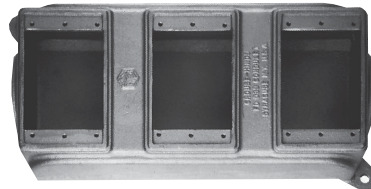

FS039, FD039 three gang



FS097, FD097 two gang tandem

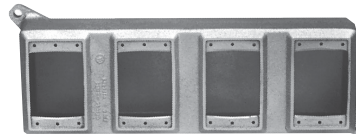

FD04 four gang



FD05 five gang

Ordering Information:

Description	Shallow Cat. #	Deep Cat. #
Single gang	FS019	FD019*
Two gang	FS029	FD029*
Three gang	FS039	FD039*
Four gang		FD04
Five gang		FD05
Two gang (takes one two gang cover)	FS062	FD062
Three gang (takes one three gang cover)	FS063	FD063
Four gang (takes one four gang cover)	FS094	FD094
Two gang tandem	FS097	FD097

*Available in copper-free aluminum. To order add suffix SA to Cat. No.

2F Condulet® Blank Device Boxes - Cast Iron

Blank Bodies for Drilling and Tapping Ordering Information

2F

Ordering Information:

To order one of the blank bodies with drilled and tapped holes listed on see pages 31-33, proceed as follows:

Step 1

Select the required box.

Step 2

Select the arrangement that meets the requirements from Table 1.

Step 3

Determine the maximum size and spacing of conduit openings from Table 2.

Step 4

Substitute the appropriate symbol from Table 4 for each conduit entrance, using "0" (zero) for those locations on arrangement where an entrance is not required.

Example:

Step 1 – box required FS062

Step 2 – arrangement 1

Step 3 – conduit entrances – 1/2" at "a", none at "b"; 1" at "c" and "d"; none at "e" and "f".

Step 4 – symbols are substituted and written in alphabetical order starting with location "a". For this example A0CC00.

Complete Cat. No. is made up of three parts:

Part 1 – box number;

Part 2 – arrangement number;

Part 3 – symbols for conduit entrances.

For this example:

FS062-1-A0CC00.

Table 1/Drilling and Tapping Arrangements*

Two, Three, Four and Five Gang

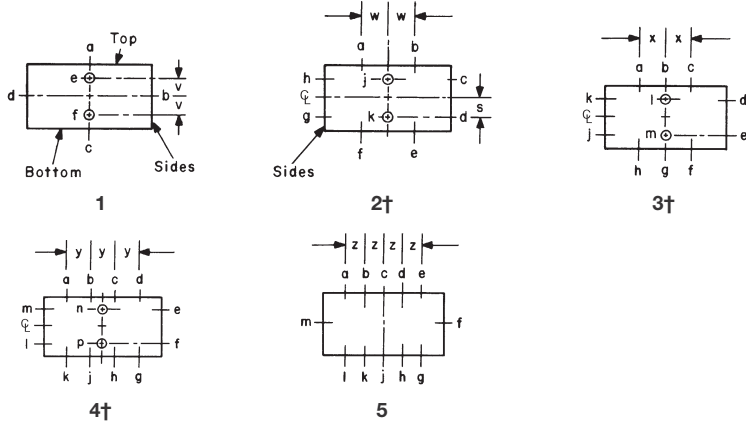

*Drilling and tapping arrangements other than those in Table 1 are available. Consult Eaton's Crouse-Hinds. †If only one conduit entry is specified or permitted (see Table 2) on a side wall that conduit entry will be centered on the wall.

Single Gang Only (FS or FD019)

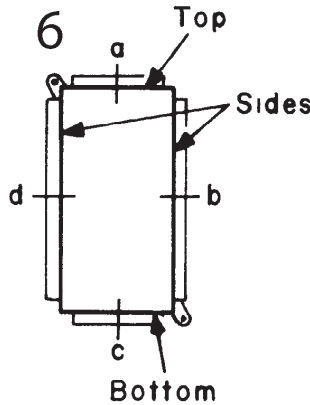

Two Gang Tandem (FS or FD097)

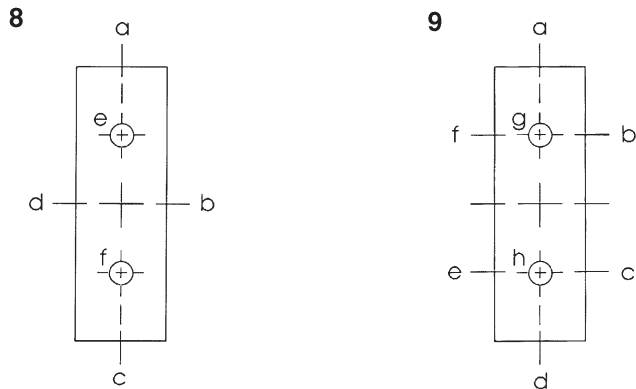

Blank Bodies for Drilling and Tapping Single-Gang, Multi-Gang, Tandem

2F

Table 2/Maximum Number, Size and Spacing of Conduit Openings

Cat. #	Maximum Conduit Opening Size														
	Top and Bottom					Sides		Back	Spacings						
	1	2	3	4	5	1	2	2	s	v	w	x	y	z	
FS019	1					1									
FD019*	1½					1½									
FS029	1	1	1	¾		1					1⅞	1⅞	1⅝ ₁₆		
FD029*	1½	1½	1	¾		1½					1⅞	1⅞	1⅝ ₁₆		
FS039	1	1	1	1	1	1					3¾	3¾	2½	1⅞	
FD039*	1½	1½	1½	1½	1	1½					3¾	3¾	2½	1⅞	
FD04	1½	1½	1½	1½		1½	1			1⅜ ₁₆	1⅞	3¾	3¾	3¾	
FD05	1½	1½	1½	1½	1½	1½	1	1		1⅜ ₁₆	3¾	3¾	3¾	3¾	3¾
FS062	1	1	¾			1	1	1		1¼	29/32	1⅝			
FD062	1½	1¼	¾			1½	1	1¼	1	1	1	1⅝			
FS063	1	1	1	¾		1	1	1		1¼	1⅜ ₁₆	1⅜ ₁₆	1⅝		
FD063	1½	1¼	1	¾		1½	1	1¼	1	1	1⅜ ₁₆	2	1⅞ ₁₆		
FS094	1	1	1	1	¾	1	1	1		1¼	1⅜ ₁₆	1⅜ ₁₆	1⅜ ₁₆	1⅝	
FD094	1½	1½	1½	1	¾	1½	1	1		1⅝	1½	2⅝	1⅜ ₁₆	1⅝	
FS097	1	1½				1	1	1½		1⅝ ₁₆	¾				
FD097	1½	1½				1½	1½	1½		1⅝ ₁₆	¾				

Table 3/Distance From Mounting Surface to Centerline of Conduit Opening ("u")

Cat. #	u
FS019	29/32
FD019*	1⅜
FS029	29/32
FD029*	1⅜
FS039	31/32
FD039*	1⅜
FD04	1⅜ ₁₆
FD05	1⅜ ₁₆
FS062	1⅜ ₃₂
FD062	1⅝
FS063	1⅜ ₃₂
FD063	1⅝
FS094	1⅜ ₃₂
FD094	1⅜ ₁₆
FS097	1⅜ ₃₂
FD097	1⅜ ₁₆

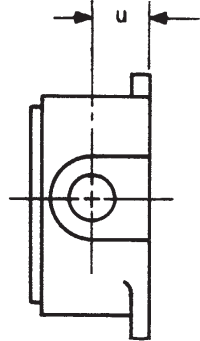

Table 4/Symbols for Openings

Conduit Size	Symbol
½	A
¾	B
1	C
1¼	E
1½	F
None	0

*Available in copper-free aluminum. To order add suffix SA to Cat. No.

2F Condulet® Cast Device Boxes

Blank Bodies for Drilling and Tapping
Single-Gang, Multi-Gang, Tandem
Dimensions (In Inches)

2F

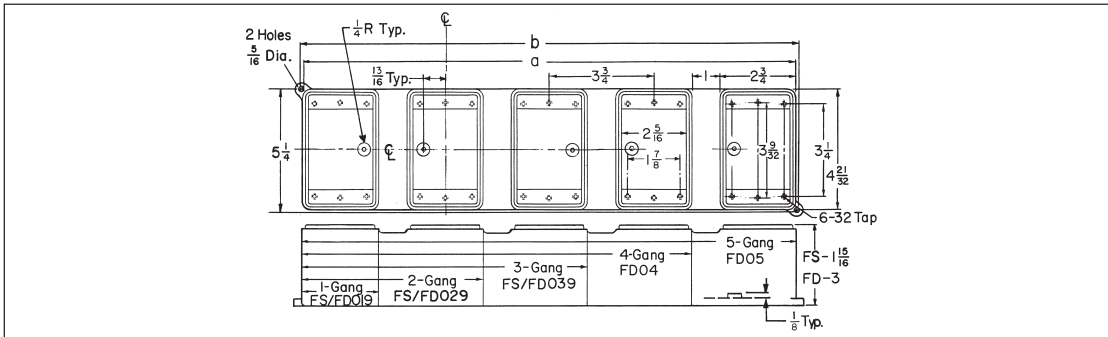

Cat. #	a	b
FS/FD019	3 1/4	3 1/4
FS/FD029	7	7
FS/FD039	10 3/4	10 1/4
FDO4	14 3/8	15
FDO5	18 1/8	18 1/4

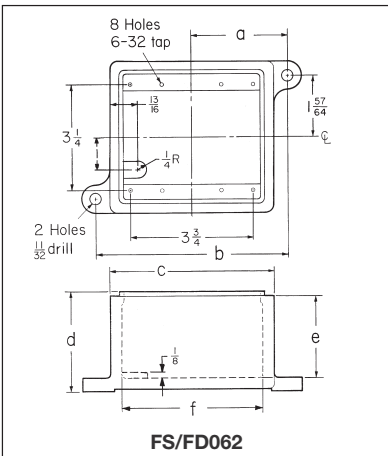

Cat. #	a	b	c	d	e	f
FS062	2 7/8	5 3/4	5	2 3/16	1 1/2	4 3/8
FD062	2 15/16	5 1/8	5 1/16	3 1/16	2 1/2	4 1/16

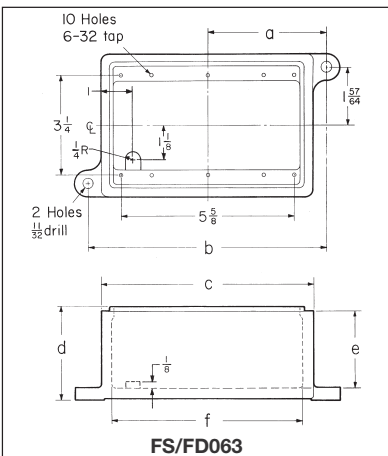

Cat. #	a	b	c	d	e	f
FS063	3 13/16	7 7/8	6 7/8	2 3/16	1 1/2	6 1/4
FD063	3 7/8	7 1/4	7 1/16	3 1/32	2 1/2	6 3/16

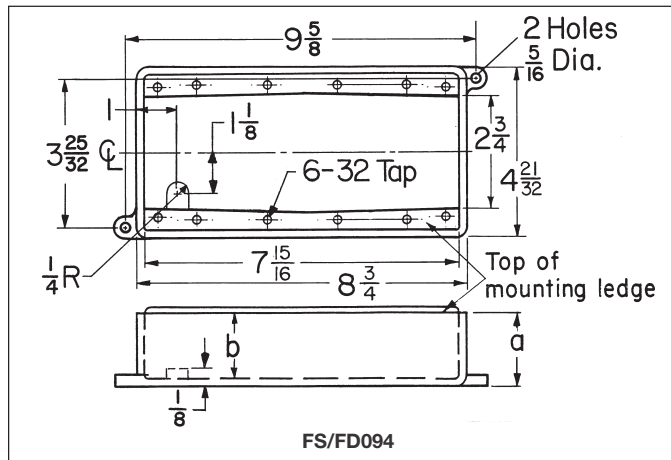

Cat. #	a	b
FS094	2 7/16	1 45/64
FD094	3	2 1/2

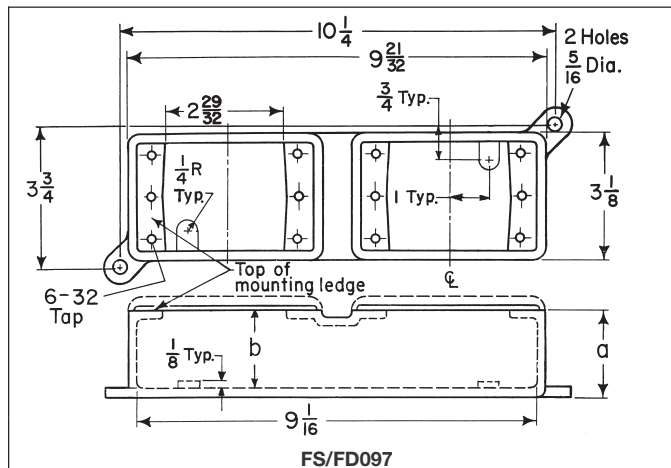

Cat. #	a	b
FS097	2 1/32	1 1/2
FD097	2 27/32	2 1/16

Condulet® Stainless Steel Conduit Device Boxes, Covers and Gaskets

2F

2F

Eaton's Crouse-Hinds Condulet® Stainless Steel Device Boxes deliver power where you need it, saving you time and money throughout the life of your facility.

Superior resistance to corrosion and heat, combined with unmatched strength, make stainless steel Condulet bodies and boxes a long-term solution for even the most extreme environments.

Applications:

Cast device boxes are installed in conduit systems to:

- Accommodate wiring devices
- Act as pull boxes for conductors in a conduit system
- Provide openings to make splices and taps in conductors
- Provide access to conductors for maintenance and future system changes
- Connect conduit systems

Features:

- Self-healing properties of stainless steel fittings help reduce the penetration of rust/corrosion and eliminate damage to the fitting
- Stainless steel fittings retain their strength in extreme heat and extreme cold conditions
- Fitting surface is easy to maintain and keep clean
- Easy cleaning capabilities make these fittings perfect for food processing and other hygienic areas where wash downs are common
- Superior strength and durability greatly reduce replacement of fittings - this will lower your total cost of ownership and increase your return on investment
- Stainless steel fittings do not require harsh environment-damaging cleaners to keep them looking like new
- Internal green grounding screw - standard
- Tapered threads for protection of wire insulation
- Wide selection of covers available
- Single or double conduit entry
- Ample wiring room provided for easy installations

Certifications and Compliances:

- UL Standard 514A
- CSA Standard C22.2 No. 18.1-04
- Raintight - when installed with cover and gasket

Standard Materials:

- Bodies - 316 stainless steel
- Covers - 316 stainless steel
- Cover Screws - 316 stainless steel
- Gasket - neoprene



Dimension

A	Length of box
B	Overall length (including hubs)
C	Width of box
D	Overall width (including hubs)
E	Height of box
F	Overall height (including hubs)

2F Condulet® Stainless Steel Conduit Device Boxes, Covers and Gaskets

The Ultimate in Corrosion Resistance and Durability

2F

Ordering Information

FD Device Body

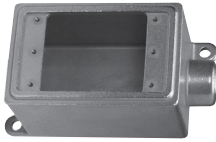

Catalog Number	Trade Size	A	B	C	D	E	F
FD2SS	3/4"	4.63	5.41	2.94	2.94	3.03	3.03

FDC Device Body



Catalog Number	Trade Size	A	B	C	D	E	F
FDC2SS	3/4"	4.63	6.19	2.94	2.94	3.03	3.03

FDS Device Body



Catalog Number	Trade Size	A	B	C	D	E	F
FDS2SS	3/4"	4.63	5.41	2.94	2.94	3.03	3.03

FDA Device Body



Catalog Number	Trade Size	A	B	C	D	E	F
FDA2SS	3/4"	4.63	4.63	2.94	2.94	3.03	3.80

FDX Device Body



Catalog Number	Trade Size	A	B	C	D	E	F
FDX2SS	3/4"	4.63	6.19	2.94	4.50	3.03	3.03

Ordering Information - Device Box Cover and Gasket

Blank Cover

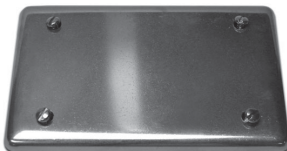

Catalog Number
DS7000BC

Blank Formed Cover



Catalog Number
DS7000BF

Switch Formed Cover



Catalog Number
DS7000SF

Receptacle Formed Cover



Catalog Number
DS7000RF

Covers for Cast Iron or Aluminum Device Boxes

WLRS and WLG Wet Location Covers

For NEMA Configuration Receptacle Interiors and GFCI Receptacles

Applications:

WLRS, WLRD and WLG series wiring device covers are designed to meet the total NEC Code requirements for wet locations. WLRS, WLRD and WLG series covers are suitable for use in wet and damp locations:

- Wherever portable equipment is required
- As general purpose utility receptacle covers
- For industrial, commercial or residential use
- In areas where electrical requirements do not exceed medium duty ratings
- To mount FS and FD single-gang or multi-gang boxes having individual cover openings (see Sect. 2F for listings)
- To mount on most flush device boxes (see Accessories)

Features:

WLRS, WLRD and WLG covers:

- Self-closing spring door assures protection of wiring device at all times, in wet and damp locations
- One piece EPDM gasket provides environmental protection of wiring device at all times
- EPDM gasketing material offers excellent resistance to ozone, weather and temperature extremes of -50°F to 260°F
- Die cast, copper-free aluminum construction with aluminum lacquer finish provides maximum corrosion resistance
- Positive ground path ensured for all exposed metal parts

NEMA configuration receptacle interiors:

- Comply with NEMA Standards WD-1 and WD-5
- Grounded through an extra contact in all types except 3-phase applications; self grounded in duplex variety
- Back and side wired
- Offered in single and duplex configurations for use with standard plugs
- Specification grade

Certifications and Compliances:

- ANSI/UL Standard 514A
- NEC Code 410-57
- OSHA Standards, Subpart "S"
- NEMA Standards WD-1, 1974 (Straight Blade) and WD-5, 1972 (Locking Type)

Standard Materials:

- WLRS, WLRD and WLG face plate and cover – die cast copper-free aluminum
- Cover hinge spring – stainless steel
- Cover screws – corrosion resistant metal
- Gasket – ethylene propylene rubber (EPDM)

Standard Finishes:

- Copper-free aluminum – aluminum lacquer

Electrical Rating Ranges:

- 15 amperes; 125, 250, or 277 volts
- 20 and 30 amperes; 125, 250, 277, 480, 600, 125 / 250, 208 / 120, 480 / 277 or 600 / 347 volts

Accessories:

- Flush mounting adapter – WLRA-1 required for mounting on device boxes. (Order separately)



Typical installation

Spring Door Covers – with Gasket*

For NEMA Configuration Round Receptacles

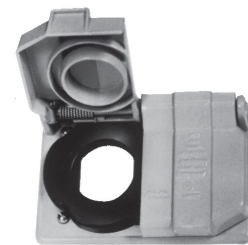

Single cover Cat. #	Diameter	Duplex cover Cat. #	Diameter
WLRS1	1 ³ / ₈ "	WLRD1	1 ³ / ₈ "
WLRS2	1 ¹ / ₂ "		

*Patent Number 4,058,358
†Horizontal mount only.

Spring Door Covers – with Gasket*

For GFCI Receptacles in Wet Locations



Horizontal Mount
for flush
device boxes
Cat. #

WLG F



Horizontal Mount
for FS and FD
device boxes
Cat. #

WLG F S



Vertical Mount
for FS and FD
device boxes
Cat. #

WLG F S V

Covers for Cast Iron or Aluminum Device Boxes WLRS and WLG Wet Location Covers

For NEMA Configuration Receptacle Interiors and GFCI Receptacles

2F

Ordering Information - Covers with and without NEMA Configuration Receptacles For Non-Locking Blade Plugs

Type	Volts	NEMA Configuration	Complete Cover with Receptacle Assy. Cat. #	Spring Door Cover & Gasket Only Cat. #*
Single Device				
2-Pole 3-Wire Grounding 15 Amp	125V	5-15R	WLRS 5 15	WLRS1
2-Pole 3-Wire Grounding 20 Amp	125V	5-20R	WLRS 5 20	WLRS1
2-Pole 3-Wire Grounding 15 Amp	250V	6-15R	WLRS 6 15	WLRS1
2-Pole 3-Wire Grounding 20 Amp	250V	6-20R	WLRS 6 20	WLRS1

Type	Volts	NEMA Configuration	Complete Cover with Receptacle Assy. Cat. #	Spring Door Cover & Gasket Only Cat. #*
Duplex Device				
2-Pole 3-Wire Grounding 15 Amp	125V	5-15R	WLRD 5 15	WLRD1
2-Pole 3-Wire Grounding 20 Amp	125V	5-20R	WLRD 5 20	WLRD1
2-Pole 3-Wire Grounding 15 Amp	250V	6-15R	WLRD 6 15	WLRD1
2-Pole 3-Wire Grounding 20 Amp	250V	6-20R	WLRD 6 20	WLRD1

Ordering Information - Covers with and without NEMA Configuration Receptacles For Locking Blade Plugs

Type	Volts	NEMA Configuration	Complete Cover with Receptacle Assy. Cat. #	Spring Door Cover & Gasket Only Cat. #*
Single Device				
2-Pole 3-Wire Grounding 15 Amp	125V	L5-15R	WLRS L5 15	WLRS1
2-Pole 3-Wire Grounding 20 Amp	125V	L5-20R	WLRS L5 20	WLRS2
2-Pole 3-Wire Grounding 15 Amp	250V	L6-15R	WLRS L6 15	WLRS1
2-Pole 3-Wire Grounding 20 Amp	250V	L6-20R	WLRS L6 20	WLRS2

Type	Volts	NEMA Configuration	Complete Cover with Receptacle Assy. Cat. #	Spring Door Cover & Gasket Only Cat. #*
Duplex Device				
2-Pole 3-Wire Grounding 15 Amp	125V	L5-15R	WLRD L5 15	WLRD1

*Must be used with a wet locations rated wiring device.

Dimensions In Inches:

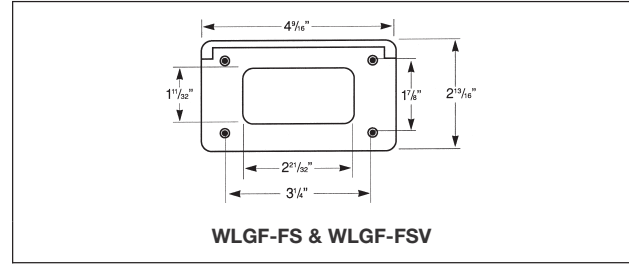
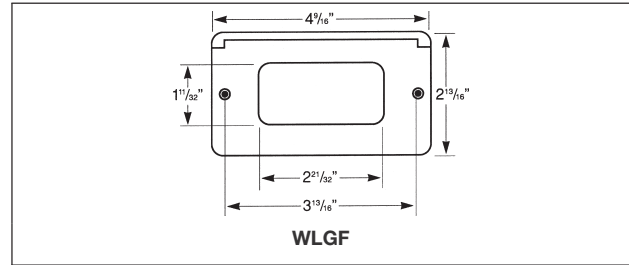
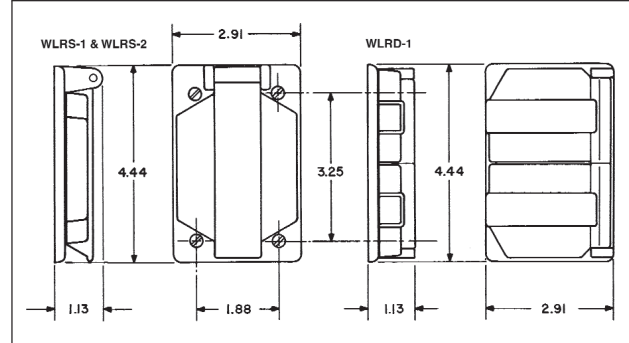

Single Gang

Ordering Information



Blank cover for enclosing splices and taps where device not used.

Description	Material	Cat. #
Surface	Sheet aluminum	DS100
Flush	Sheet steel	DSS100



Blank cover with gasket for enclosing splices and taps where device not used.

Description	Material	Cat. #
Surface or Flush	Cast aluminum	DS100G



DS21

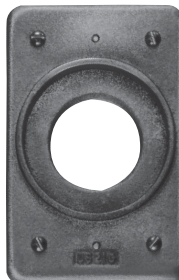

DS21G

For standard and 3-pole, 2-wire grounding type round flush receptacles. Opening diameter 1⁷/₁₆".

Description	Material	Cat. #
Surface	Sheet steel	DS21
Surface	Sheet aluminum	DS21 SA
Surface or flush	<i>Feraloy</i> [®] iron alloy with gasket	DS21G



For GFI receptacles.

Description	Material	Cat. #
Surface	Sheet steel	DS23 GFI



For flush plug receptacle requiring 1¹/₈" opening diameter.

Description	Material	Cat. #
Surface	Sheet steel	DS35

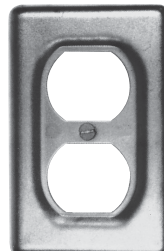

For duplex convenience receptacles.

Description	Material	Cat. #
Surface	Sheet steel	DS23
Surface	Sheet aluminum	DS23 SA
Flush	Sheet steel	DSS23



For standard and 3-pole, 2-wire grounding type duplex convenience receptacles. Gasket included.

Description	Material	Cat. #
Surface or flush	<i>Feraloy</i> [®] iron alloy	DS23G



For square handle general use snap or toggle switches - unguarded.

Description	Material	Cat. #
Surface	Sheet steel	DS32
Surface	Sheet aluminum	DS32 SA

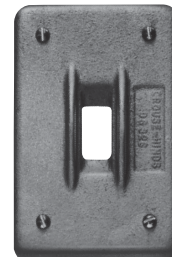

For square handle general use snap or toggle switches - guarded.

Description	Material	Cat. #
Surface or flush	<i>Feraloy</i> [®] iron alloy with gasket	DS32G
Surface	Sheet steel	DS52

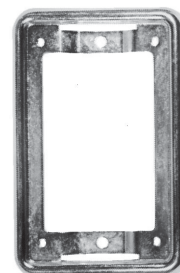

Adapter plate for mounting WLRS/WLRD covers to flush device boxes.

Description	Cat. #
Flush Device Adapter	WLRA1

Also can be used to mount all covers with four corner screws listed see pages 37, 39, 40, 41, 42 and 43 to flush device boxes.

See page 42 for receptacle specifications and listings of complete receptacle/cover combinations.
†Must be used with a wet locations rated wiring device.

2F Covers for Cast Iron or Aluminum Device Boxes

Single Gang - Raintight Covers (Gasket Included)

2F

Ordering Information

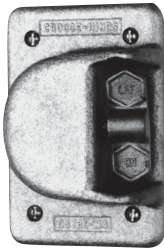

For general use snap switches.
Includes gasket.

Description	Material	Cat. #
For standard ON-OFF operation	Copper-free aluminum	DS181



For general use snap switches.
Includes gasket.

Description	Material	Cat. #
For standard ON-OFF operation. With hole for lock	Die cast aluminum	DS185



For general use snap switches.
Includes gasket.

Description	Material	Cat. #
For standard operation. Marked ON-OFF handle	Cast aluminum	DS128

Single Gang - Switches and Motor Control Push Button

Ordering Information

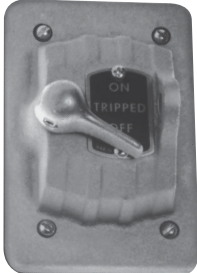

For manual motor starting switches. Fits FS and FD boxes. Takes Westinghouse switches MST01 (1-pole) and MST02 (2-pole). Includes gasket.

Description	Material	Cat. #
For standard ON-OFF operation	Feraloy iron alloy	DS199



Furnished with buttons for operating motor control push button switches. Includes gasket.

Description	Push Buttons		Material	Cat. #
	No.	Color		
Button (normally open) marked START	1	Green	Feraloy iron alloy	DS171F ①
Button (normally closed) marked STOP	1	Red	Feraloy iron alloy	DS171G ①
Button (normally open) marked START	1	Green	Feraloy iron alloy	DS171 ①
Button (normally closed) marked STOP	1	Red		

Description	No.	Color	Material	Cat. #
Two push button	2	Black	Feraloy iron alloy	DS171J ①

① If desired, markings on indicating plates may be added to catalog number. Select from the list of standard markings below:

HAND	CLOSE	OFF	AUTO.	UP	RUN
EMER.	DOWN	JOG	FORWARD	START	RESET
REVERSE	STOP	TRIP	OPEN	ON	TEST
LGT. ON					

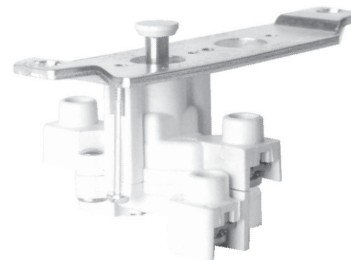

Heavy duty motor control push button switch

No. of Buttons	Normal Positions		Cat. #
1	1 circuit universal	•••	ED11
2	2 circuits universal	•••••	ED12†

†Two universal contact blocks, must be wired as two circuits, with one normally open and one normally closed.

DS Covers use the switches shown in the list below.

Cover	Takes Switch	Cover	Takes Switch
DS171	ED12	DS171F	ED11
DS171G	ED11	DS266	ED12
DS265	ED11		



Single Gang - DS Receptacles and WP Plugs

2F

Applications:

WP plugs and DS receptacles are used:

- Wherever dust, dirt, moisture and corrosion are a problem
- Outdoors or in locations where frequent washdowns occur, as in dairies and food processing plants

Features:

DS receptacle housings are used:

- With FS and FD cast device boxes, either surface mounted or installed flush in a wall
- With single gang, two gang tandem and multiple gang boxes having individual cover openings
- A threaded cap which effectively seals housing when not in use

WP plugs include:

- A molded Neoprene hood with integral sleeve to seal the cord entrance
- An aluminum ring which clamps the hood to receptacle housing face, to complete watertight seal when plug is in use

Certifications and

Compliances:

- UL Standards: 498; 514A
- NEMA/EEMAC: WD-1; WD-5
- CSA Standard: C22.2 No. 42*

*Compliance.

Standard Materials:

- Receptacle housings: body – *Feraloy*® iron alloy; cap – copper-free aluminum
- Plug exteriors: hood – Neoprene; fastening ring – copper-free aluminum

Standard Finishes:

- *Feraloy* iron alloy – electrogalvanized and aluminum acrylic paint
- Copper-free aluminum – natural
- Neoprene – natural (black or yellow)

Electrical Rating Ranges:

- 15 amperes, 125 volts
- 20 amperes, 125, 250 volts



DS Receptacle housings

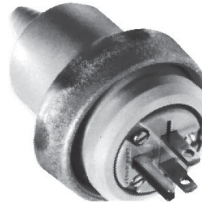

WP Plugs



CC Replacement receptacle

Grounding Type Receptacles

For Plugs with U shaped or Round Grounding Contacts

Rating	Cover With Recept. Cat. #	Diagram	Style	Plug Cat. #	Diagram	Cord Dia.	Repl. Recept. Cat. #
15 amps 125 volts	DS96*		2-wire, 3-pole†	WP820		.500 to .625	CC55
		NEMA: 5-15R			NEMA: 5-15P		
20 amps 125 volts	DS222		2-wire, 3-pole†	WP832		.500 to .625	CC71
		NEMA: 5-20R			NEMA: 5-20P		
20 amps 250 volts	DS290		2-wire, 3-pole†	WP930		.500 to .625	CC90
		NEMA: 6-20R			NEMA: 6-20P		

†Third pole grounded.
*Compliance

For listing of typical FS cast devices boxes, see pages 23 and 24.

Single Gang - Pilot Light Covers, Extensions and Adapters

Ordering Information



For pilot light units (furnished with jewels)

Description	Material	Jewel Color	Cat. #
Surface	Sheet steel	Red	DS24



Pilot light (with transformer)†, FD only

Circuit Voltage	Lamp Base	Watts	Cat. #
440	Candelabra	6	C333

†Transformer 50-60 cycle, 440 / 110 volts.

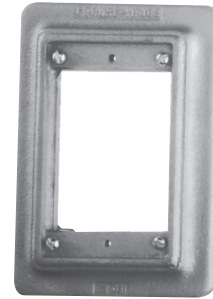

FS flush mounting adapter (can be used with multi-gang bodies having individual cover openings. Furnished with gasket and screws)

Mtg. Style	Cat. #
Wall	FS031



For pilot light units (furnished with jewel and gasket).

Description	Material	Jewel Color	Cat. #
Surface or flush	Feraloy iron alloy	Red	DS24G



EXF Extensions (takes covers and flush rectangular wiring devices, or plug receptacles with housings)

Ext. Depth	Cat. #
1"	EXF11
2½"	EXF21

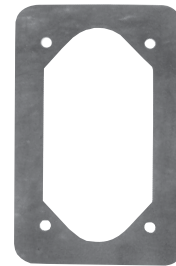

Gaskets for use between device boxes and covers.

Material	Cat. #
Neoprene	GASK91‡

‡Not recommended as watertight.

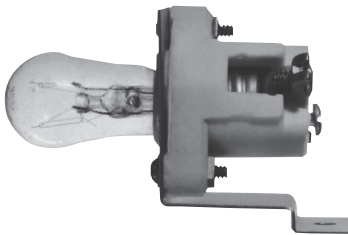

Pilot light unit (without transformer)

Circuit Voltage	Lamp Base	Watts	Cat. #
110	Candelabra	6	C3310

2F Covers for Cast Iron or Aluminum Device Boxes

Two Gang

2F

Ordering Information

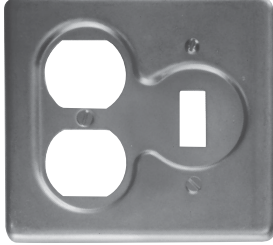

For flush general use snap switches with square handles

Material	Cat. #
Sheet steel	S32232

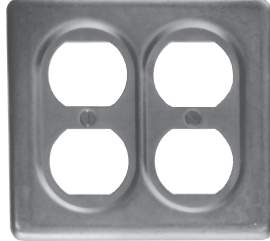

For duplex convenience receptacles, standard and 2-wire, 3-pole grounding

Description	Material	Cat. #
Surface	Sheet steel	S232

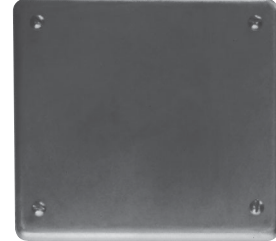

Blank. *Feraloy*® iron alloy with gasket

Description	Material	Cat. #
Surface	Sheet steel	S1002
Surface or flush	<i>Feraloy</i> iron alloy	S1002G
Surface or flush	Copper-free aluminum	S1002G SA

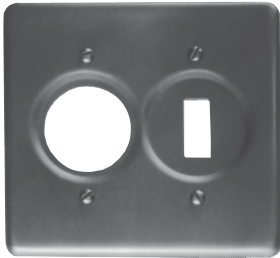

For flush general use snap switches with square handles

Description	Material	Cat. #
For round plug flush receptacles. Surface	Sheet steel	S32212



For GFI receptacles

Description	Material	Cat. #
Surface	Sheet steel	S232 GFI

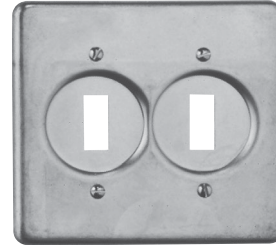

For flush general use snap switches with square handles

Description	Material	Cat. #
Surface	Sheet steel	S322

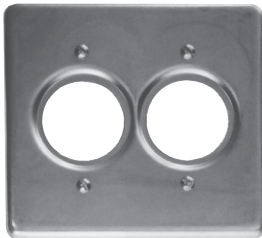

For standard and 2-wire, 3-pole grounding

Description	Material	Cat. #
For round plug flush receptacles. Surface	Sheet steel	S212



For round flush receptacles, duplex convenience receptacles, standard and 2-wire, 3-pole grounding

Description	Material	Cat. #
Surface	Sheet steel	S21232

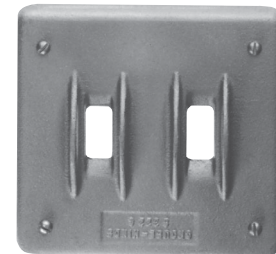

For flush general use snap switches with square handles

Description	Material	Cat. #
Surface or flush	<i>Feraloy</i> iron alloy	S322G

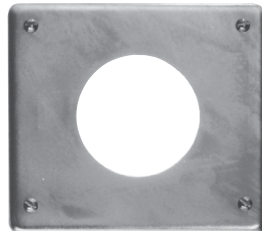

For 20 amp., 250 volt receptacles

Description	Material	Cat. #
2-pole, Surface	Sheet steel	S612

Two Gang

Ordering Information

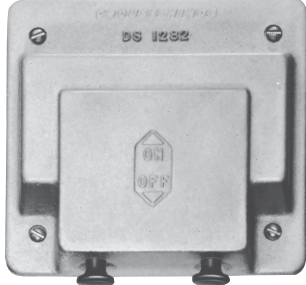

With operating mechanism and gasket

Description	Material	Cat. #
Two gang. For operation of general use snap switches. Surface or flush	Feraloy® iron alloy	DS1282

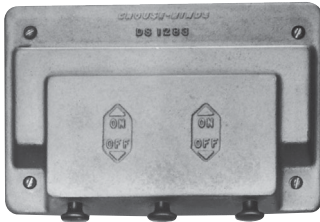

With operating mechanism and gasket

Description	Material	Cat. #
Three gang with gasket. For external operation of general use snap switches. Surface or flush.	Feraloy iron alloy	DS1283



Blank with gasket

Description	Material	Cat. #
Surface	Sheet steel	S1003
Surface or flush	Feraloy iron alloy	S1003G
Surface or flush	Copper-free aluminum	S1003G SA

*Includes gasket

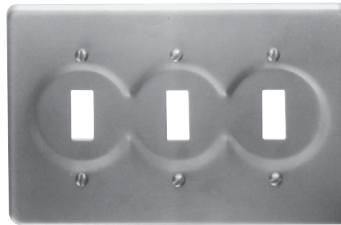

For flush general use snap switches with square handles

Description	Material	Cat. #
Surface, three gang	Sheet steel	S323

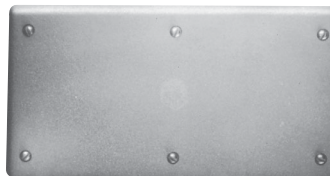

Blank with gasket

Description	Material	Cat. #
Surface or flush	Feraloy iron alloy	S1004G

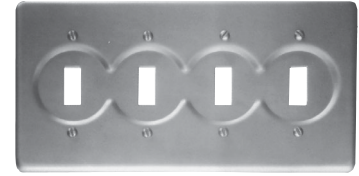

For flush general use snap switches with square handles

Description	Material	Cat. #
Surface, four gang†	Sheet steel	S324

†For FS094 and FD094 boxes.



Gasket for use between device box and cover

Description	Material	Cat. #
Two gang	Rubber	GASK434
Three gang	Rubber	GASK460
Four gang	Rubber	GASK461

2F FSE Receptacle and Breaker Assemblies

2F

Applications:

- FSE series assemblies are used in outdoor areas for supplying power in remote locations, particularly parking lots, automobile engine block heaters, marinas, drive-in theaters, trailer camps, etc.

Features:

- Compact design.
- Suitable for a variety of combinations.
- U ground duplex receptacle.
- Circuit breaker protection.
- Breakers cannot be manually tripped.

Certifications and Compliances:

- CSA Standard C22.2 No. 18

Standard Materials:

- Body and cover – copper-free aluminum

Standard Finishes:

- Copper-free aluminum – natural

Electrical Ratings:

- 15A 120V

Size:

- 2" integral hub for pole mounting.



FSE 6121



FSE 612

Ordering Information

Cat. #	Description
--------	-------------

FSE612	Double face receptacle body only
--------	----------------------------------

FSE6121	Fitting complete with 1-15 amp. duplex receptacle and blank cover.
---------	--

FSE6122	Fitting complete with 2-15 amp. duplex receptacles.
---------	---

FSE61212	Fitting complete with 1-15 amp. duplex receptacle and two 1- pole Minibreakers
----------	--

FSE61211	Fitting complete with 1-15 amp. duplex receptacle and one 1- pole Minibreaker.
----------	--

Other combinations available on request



Description	Page No.
Application/Selection	see page 48
Lubricants	
HTL	see page 63
STL	see page 63
Conduit Bodies & Outlet Boxes	
Cylindrical	
EKC	see page 60
90° Elbow	
FE	see page 62
LBH	see page 61
LBY	see page 61
Rectangular	
OE	see page 59
Round	
C30 and C31 for IEC Applications	see page 57
CPS	see page 58
GUA	see pages 50–51
EAB	see page 54
EAB ATEX	see page 55
EAJ	see page 56
GUR Universal	see page 53
Tees	
Short Radius	
ET	see page 61
FT	see page 62

Condulet® Conduit Bodies and Outlet Boxes

Application and Selection

Applications:

Hazardous area conduit bodies and outlet boxes are installed in rigid conduit systems in Class I and II hazardous locations to:

- Protect conductors
- Act as pull and splice boxes
- Connect lengths of conduit
- Change conduit direction
- Provide access to conductors for maintenance and future system changes
- Act as mounting outlets for fixtures (with appropriate covers)
- Act as sealing fittings (with appropriate covers)

Options and Accessories:

- Flat blank covers (surface and flanged flush), fixture support and sealing covers and extensions are available. See specific product listing for details.
- Lubricant (STL and HTL) are available to make joints raintight, provide for easy cover removal and to lubricate shafts over a wide temperature range.
- *Corro-free*™ epoxy powder coat – information available on request.

Considerations for Selection:

- Determine the area classification per National Electrical Code Hazardous Area Groups. Based on this classification, select the product families that are acceptable for use in the particular location.:
- Establish functional physical requirements these will help to determine box size, cover, shape and mounting for the particular installation.
- Each product family has features suitable for specific functions:
- i.e., boxes used as mountings for lighting fixtures are generally of a small size, and provided with mounting lugs when required to support lighting fixtures.
- Boxes used for wire pulling should generally be larger to provide room for easy pulling.
- Boxes used to splice and/or tap conductors should be large enough to permit ease of work and sufficient room for the required size and number of conductors.
- Hub size and configuration – dependent on the conduit system configuration and the conduit size used.
- Material and finish – determine from environmental conditions (corrosive fumes, weather, buried in concrete, etc.)



















Quick Selector Chart

Series	NEC Class I & II Groups	IEC Certifications	Normal Function	Cover Opening Diameter	Hub Size†	Cover Type
GUA	C, D E, F, G		Mtg. lgt. fixt., taps, pulling, splicing	2-5	1/2-2	Threaded
EAJ	A, B, C, D E, F, G		Pulling, splicing, taps	3 3/16 & 5	1/2-2	Threaded
C30 / C31		Ex II 2 G EEx d IIC T6 Ex II 2 D IP66 T 85°C	Pulling, splicing, taps	98mm (C30) 130mm (C31)	1/2-1	Threaded
EAB	A, B, C, D E, F, G		Pulling, splicing, taps	3	1/2-1	Threaded
EAB ATEX	A, B, C, D E, F, G	II 2 G EEx d IIC T5 PTB 05 ATEX 1052	Pulling, splicing, taps	3 3/4	1/2-1	Threaded
CPS	C, D E, F, G		Fixt. support, pulling, splicing	3 1/2	1/2 & 3/4	Ground joint
OE	C, D E, F, G		Pulling		1/2-1	Ground joint
ET	C, D E, F, G		Stub up		1/2-1	
FT		Flameproof, Exd, IIB, IP67, Zone 1 Combustible Dust Zone 21 & 22	Stub up		20mm - 25mm	Threaded
LBY	C, D E, F, G		Pulling		1/2 - 1 1/4	Threaded
LBH	B, C, D E, F, G		Pulling		1/2-4	Ground joint
FE		Flameproof, Exd, IIB, IP67, Zone 1 Combustible Dust Zone 21 & 22	Pulling		20mm - 25mm	Threaded
EKC	C, D E, F, G		Pulling		1/2-3	Ground joint
GUR	C, D E, F, G		Pulling, splicing		1/2-1	Threaded





†See following table for standard hub configuration.

Condulet® Conduit Bodies and Outlet Boxes

Standard Shape and Hub Selector

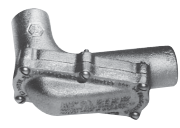
Shape Series	Page	Hub Style										
												
 GUA	see pages 50-52	GUA	GUAB	GUAC	GUAD	GUAL	GUAM	GUAN	GUAT	GUAW	GUAX	
 EAB	see page 54			EABC		EABL			EABT		EABX	EABY
 C30 / C31	see page 57								C30 / C31		C30 / C31	
 EAJ	see page 56		EAJB	EAJC	EAJD	EAJL			EAJT		EAJX	
 CPS	see page 58											CPS
 GUR	see page 53											GUR
 OE	see page 59		OELB	OEC		OELL		OELR	OET			

The fittings below are available only in the configurations shown.

					
LBH see page 61	LBY see page 61	FE see page 62	EKC see page 60	ET see page 61	FT see page 62



Condulet® Conduit Outlet Boxes With Covers

GUA Series

Cl. I, Div. 1 & 2, Groups C, D
 Cl. II, Div. 1, Groups E, F, G
 Cl. II, Div. 2, Groups F, G
 Cl. III
 NEMA 3, 4, 7CD, 9EFG

Explosionproof
 Dust-Ignitionproof
 Raintight
 Wet Locations

3F

Applications:

GUA series conduit outlet boxes are installed within hazardous area conduit systems to:

- Protect conductors in threaded rigid conduit
- Act as pull and splice boxes
- Connect lengths of conduit
- Change conduit direction
- Provide access to conductors for maintenance and future system changes
- Act as mounting outlets for fixtures (with appropriate covers)
- Act as sealing fittings (with appropriate covers)

Features:

GUA conduit boxes have:

- Neoprene "O" ring standard to meet NEMA 4 requirements
- Cast ears on cover to permit easy removal and tightening
- Four standard mounting pads except for boxes with bottom hubs
- Threaded cover openings
- Ten different hub arrangements
- Taper threaded hubs to provide grounding continuity
- Smooth integral hub bushing protects conductor insulation when pulling
- Surface covers furnished with boxes
- Sealing covers, dome covers, and fixture hanger covers are available
- Cover threads are 12 pitch

Certifications and Compliances:

- NEC/CEC:
 - Class I, Division 1 & 2, Groups C, D
 - Class II, Division 1, Groups E, F, G
 - Class II, Division 2, Groups F, G
 - Class III
- UL Standard: 1203
- ANSI Standard: C33.27
- CSA Standard: C22.2 No. 30
- NEMA/EEMAC 3, 4

Standard Materials:

- Bodies – *Feraloy* iron alloy
- Covers – Copper-free aluminum

Standard Finishes:

- *Feraloy* iron alloy – electrogalvanized and aluminum acrylic paint
- Aluminum – natural

Size Ranges:

- Hub – 1/2" to 2"
- Cover opening – 2" to 5" dia.

Options:

Description
 Bodies – copper-free aluminum
 Covers – *Feraloy* iron alloy – electrogalvanized and aluminum acrylic paint
 GUA Form 6 (with 3" cover opening) are available with optional cover with viewing window.
WOD
VW
S752
Suffix
SA†*

To order box less cover add "0" to end of catalog number ie.GUAT260.

When assembled with sealing type cover, GUA series outlet boxes provide adequate sealing for 40% fill in hazardous areas – Class I, Groups C, D; Class II, Groups E, F, G; and Class III. Seals can be made in either horizontal or vertical positions. Use *Chico*® "A" sealing compound or *Chico*® SpeedSeal only. Conductor splices or connections must not be made in enclosures where sealing compound is to be used per NEC.

GUA



Hub Size	Cover Opening Dia.	Cat. #
1/2	2	GUA14
3/4	2	GUA24
1/2	3	GUA16
3/4	3	GUA26*
1	3	GUA36
1 1/4	3 3/8	GUA47
1 1/2	5	GUA59

GUAC



Hub Size	Cover Opening Dia.	Cat. #
1/2	2	GUAC14†
3/4	2	GUAC24†
1/2	3	GUAC16*
3/4	3	GUAC26*
1	3	GUAC36*
1 1/4	3 3/8	GUAC47†
1 1/4	5	GUAC49
1 1/2	5	GUAC59†
2	5	GUAC69†

†Available in copper-free aluminum, add suffix -SA.
 *Available in copper-free aluminum, add suffix -SA. GUA outlet boxes marked with * when ordered with suffix -SA are listed for Class I, Division 1 & 2, Groups B, C and D, Class II, Division 1, Groups E, F, G and Class III. Covers have 16 pitch threads. Replacement cover is a GUA06-GB.

GUAB

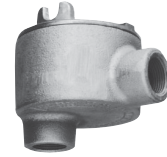

Hub Size	Cover Opening Dia.	Cat. #
1/2	2	GUAB14†
3/4	2	GUAB24
1/2	3	GUAB16*
3/4	3	GUAB26*
1	3	GUAB36*
1 1/4	3 3/8	GUAB47†
1 1/2	5	GUAB59†
2	5	GUAB69†

GUAD

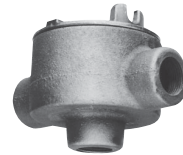

Hub Size	Cover Opening Dia.	Cat. #
1/2	2	GUAD14†
3/4	2	GUAD24
1/2	3	GUAD16
3/4	3	GUAD26†
1	3	GUAD36†
1 1/4	5	GUAD49

Dimensions In Inches:

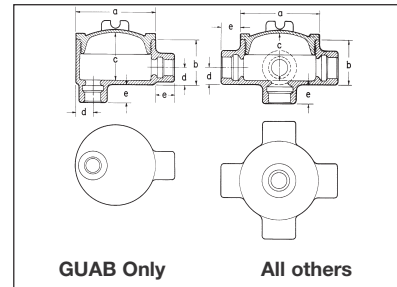

GUA, GUAD, GUAM, GUAW, GUAX

Cat. #	a	b	c	d
14	2 1/2	1 13/16	1 3/4	5/8
24	2 1/2	2	2	3/4
16	3 1/2	2	1 7/8	5/8
26	3 1/2	2	1 7/8	3/4
36	3 1/2	2 5/16	2 3/16	7/8
37	4 1/4	2 5/16	2 7/8	7/8
47	4 1/4	2 11/16	2 3/4	1 3/32
49	5 3/4	3 3/16	3 3/4	1 3/32
59	5 3/4	3 3/16	3 3/4	1 9/32
69	5 3/4	4 1/16	4	1 9/16

Length of Hub Hub Size	Dimension "e" Length
1/2 - 3/4	7/8
1 - 1 1/4	1
1 1/2 - 2	1 1/16

Crouse-Hinds
 by **E.T.N**

Condulet® Conduit Outlet Boxes With Covers

GUA Series

Cl. I, Div. 1 & 2, Groups C, D
 Cl. II, Div. 1, Groups E, F, G
 Cl. II, Div. 2, Groups F, G
 Cl. III
 NEMA 3, 4, 7CD, 9EFG

Explosionproof
 Dust-Ignitionproof
 Raintight
 Wet Locations

3F

3F

GUAL



Hub Size	Cover Opening Dia.	Cat. #
1/2	2	GUAL14†
3/4	2	GUAL24†
1/2	3	GUAL16*
3/4	3	GUAL26*†
1	3	GUAL36*
1 1/4	3 5/8	GUAL47†
1 1/4	5	GUAL49†
1 1/2	5	GUAL59†
2	5	GUAL69†

GUAN



Hub Size	Cover Opening Dia.	Cat. #
1/2	2	GUAN14
3/4	2	GUAN24
1/2	3	GUAN16
3/4	3	GUAN26
1	3	GUAN36†
1 1/4	3 5/8	GUAN47
1 1/2	5	GUAN59†
2	5	GUAN69

GUAT



Hub Size	Cover Opening Dia.	Cat. #
1/2	2	GUAT14†
3/4	2	GUAT24†
1/2	3	GUAT16*
3/4	3	GUAT26*
1	3	GUAT36*
1	3 5/8	GUAT37
1 1/4	3 5/8	GUAT47†
1 1/4	5	GUAT49†
1 1/2	5	GUAT59†
2	5	GUAT69†

GUAX



Hub Size	Cover Opening Dia.	Cat. #
1/2	2	GUAX14†
3/4	2	GUAX24†
1/2	3	GUAX16*
3/4	3	GUAX26*
1	3	GUAX36*
1	3 5/8	GUAX37†
1 1/4	3 5/8	GUAX47†
1 1/4	5	GUAX49
1 1/2	5	GUAX59†
2	5	GUAX69†

GUAM



Hub Size	Cover Opening Dia.	Cat. #
1/2	2	GUAM14†
3/4	2	GUAM24
1/2	3	GUAM16
3/4	3	GUAM26
1	3	GUAM36
1 1/4	3 5/8	GUAM47
2	5	GUAM69

GUAW

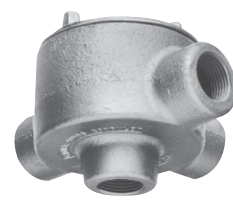

Hub Size	Cover Opening Dia.	Cat. #
1/2	2	GUAW14†
3/4	2	GUAW24†
1/2	3	GUAW16
3/4	3	GUAW26*†

Dimensions GUAC, GUAT

Cat. #	a	b	c	d
14	2 1/2	2 1/4	2 3/16	5/8
24	2 1/2	2	2	3/4
16	3 1/2	2	1 7/8	5/8
26	3 1/2	2	1 7/8	3/4
36	3 1/2	2 3/16	2 3/16	7/8
37	4 1/4	2 3/16	2 3/8	7/8
47	4 1/4	2 11/16	2 3/4	1 3/32
49	5 3/4	3 13/16	3 3/4	1 5/32
59	5 3/4	3 13/16	3 3/4	1 9/32
69	5 3/4	4 1/16	4	1 9/16

GUAN

Cat. #	a	b	c	d
14	2 1/2	2 1/8	2 1/16	5/8
24	2 1/2	2 3/16	2 1/4	3/4
16	3 1/2	2	1 7/8	3/4
26	3 1/2	2	1 7/8	3/4
36	3 1/2	2 3/16	2 3/8	7/8
47	4 1/4	2 11/16	2 3/4	1 3/32
59	5 3/4	4 1/16	4	1 9/32
69	5 3/4	4 1/16	4	1 9/16

GUAB, GUAL

Cat. #	a	b	c	d
14	2 1/2	2 1/4	2 3/16	5/8
24	2 1/2	2 1/2	2 7/16	3/4
16	3 1/2	2	1 7/8	5/8
26	3 1/2	2	1 7/8	3/4
36	3 1/2	2 3/16	2 3/16	7/8
47	4 1/4	2 11/16	2 3/4	1 3/32
49	5 3/4	3 13/16	3 3/4	1 5/32
59	5 3/4	3 13/16	3 3/4	1 9/32
69	5 3/4	4 1/16	4	1 9/16

†Available in copper-free aluminum, add suffix -SA.

*Available in copper-free aluminum, add suffix -SA. GUA outlet boxes marked with * when ordered with suffix -SA are listed for Class I, Division 1 & 2, Groups B, C and D, Class II, Division 1, Groups E, F, G and Class III. Covers have 16 pitch threads. Replacement cover is a GUA06-GB.

3F Covers and Accessories

For GUA Condulet® Conduit Outlet Boxes

3F

Applications:

Threaded covers, canopies and extensions are used:

- To provide a seal in hazardous areas (sealing cover). See note below.
- To mount pendant lighting fixtures such as EVA listed in lighting section (fixture canopy)
- To mount EVA pendant lighting fixtures on cover which is then screwed into outlet box without twisting conductors (union hub cover)
- To mount pendant lighting fixtures on cover which is then screwed into outlet box as above, for wiring after fixture stem is installed (nipple cover)
- To provide means of increasing outlet box depth (threaded extension)

Features:

- Surface covers are supplied with GUA boxes
- Sealing cover has removable plug for filling enclosure with sealing compound after installation. Sealing cover meets 40% fill requirement of the NEC®. See note below.
- Fixture canopy has a threaded cover in its side to provide access for making splices or taps. Fixture with its conduit stem and canopy can be assembled and wired before installation and conductors can be spliced in canopy after it has been screwed into the body
- Cover threads are 12 pitch.

Standard Materials:

- Surface and dome covers, union hub covers, nipple covers – copper-free aluminum
- Sealing covers, fixture canopies, threaded extensions – *Feraloy*® iron alloy

Standard Finishes:

- Aluminum – natural
- *Feraloy* iron alloy – electrogalvanized and aluminum acrylic paint

Options:

Description	Suffix
Corro-free™ epoxy powder coat	S752
To order an iron surface cover	WOD

Size Ranges:

- Fixture stems – 3/4"
- Body openings – 2" to 5"

Note: Depth of sealing compound in body must satisfy requirements of NEC section 501-5 (C-3). Splices and taps in sealing fittings are prohibited by NEC.

GUA Threaded Extension



Cover Opening Dia.	Ext. Depth	Cat. #
3	1 1/4	GUA0631

GUA Cover Opening	Replacement O-Ring Gasket Cat. #
2"	GASK1713
3"	GASK1151
3 5/8"	GASK1589
5"	GASK925

Surface Cover



Cover Opening Dia.	Thread Pitch	Cat. #
2	12	GUA04
3	12	GUA06
3	16	GUA06 GB*
3 5/8	12	GUA07
5	12	GUA09

Dome Cover



Cover Opening Dia.	Ext. Depth	Thread Pitch	Cat. #
2	2	12	GUA047
3	2	12	GUA067
3 5/8	2	12	GUA077
3 5/8	4	12	GUA0716
5	4	12	GUA514
5	10	12	GUA5110

Sealing Cover



Cover Opening Dia.	Thread Pitch	Cat. #
2	12	GUA041
3	12	GUA062
3	16	GUA062 GB*
3 5/8	12	GUA072†
5	12	GUA092

Nipple Cover



Cover Opening Dia.	Fixt. Stem Size	Thread Pitch	Cat. #
3	3/4	12	GUA0672

Fixture Cover Union Hub Type



Cover Opening Dia.	Fixt. Stem Size	Thread Pitch	Cat. #
3	3/4	12	GUA0687

Fixture Canopy



Cover Opening Dia.	Fixt. Stem Size	Thread Pitch	Cat. #
3	3/4	12	GUA068

†Also used with GUP bodies see page 753 or GU and GUE bodies see page 722.

*GUA covers with 16 pitch threads are used with GUA bodies ordered with -SA suffix identified with * symbol see pages 50-51.

Condulet® Conduit Outlet Boxes With Covers

GUR Series

Cl. I, Div. 1 & 2, Groups C, D
 Cl. II, Div. 1, Groups E, F, G
 Cl. II, Div. 2, Groups F, G
 Cl. III
 NEMA 4

Explosionproof
 Dust-Ignitionproof
 Raintight
 Wet Locations

3F

Applications:

GUR conduit outlet boxes are installed within hazardous areas:

- To protect conductors in threaded rigid conduit
- To act as pull and splice boxes
- To connect lengths of conduit
- To provide access to conductors for maintenance and future system changes
- To change conduit direction
- Where space is limited, such as underneath gasoline pumps

Features:

GUR outlet boxes feature:

- Neoprene O-ring standard in cover to meet NEMA 4/UL Type 4 requirements
- Internal green ground screw
- Five standard hubs with three pipe plugs included
- Threaded cover opening
- Recesses in cover to assist in cover tightening and removal
- Smooth, integral hub bushing to protect conductor insulation when pulling
- Compact design for confined spaces
- UL and cUL listing
- Optional all-aluminum construction

Certifications and Compliances:

- NEC/CEC
 - Class I, Division 1 and 2, Groups C and D
 - Class II, Division 1, Groups E, F and G
 - Class III
 - Zone 1 and 2
- UL Standard 1203
- cUL to CSA Standard C22.2 No. 30
- NEMA 4

Standard Materials:

- Bodies – *Feraloy*® iron alloy
- Covers – copper-free aluminum

Standard Finishes:

- *Feraloy* iron alloy – electrogalvanized with aluminum acrylic paint
- Aluminum – natural

Options:

Description

Bodies – copper-free aluminum

Suffix

SA



Ordering Information:

Hub Size	Cat. #
1/2"	GUR1
3/4"	GUR2
1"	GUR3

Dimensions

In Inches:

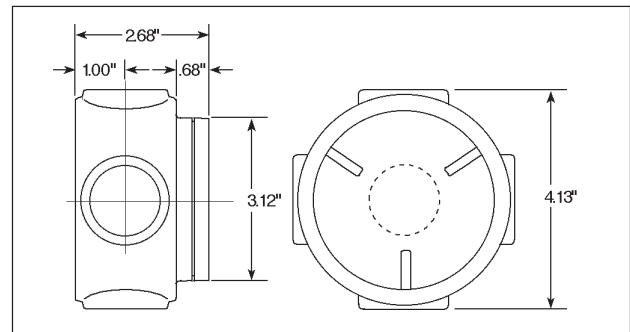

Condulet® Conduit Outlet Boxes With Covers

EAB Series

Cl. I, Div. 1 & 2, Groups A, B, C, D
 Cl. II, Div. 1, Groups E, F, G
 Cl. II, Div. 2, Groups F, G
 Cl. III
 NEMA 3,4,7ABCD,9EFG

Explosionproof
 Dust-Ignitionproof
 Raintight
 Wet Locations

3F

Applications:

EAB series conduit outlet boxes are installed in conduit systems within hazardous areas to:

- Provide protection against exterior explosion where acetylene, hydrogen and other hazardous gases are present
- Protect conductors in threaded rigid conduit
- Act as pull and splice boxes
- Interconnect lengths of conduit
- Change conduit direction
- Provide access to conductors for maintenance and future system changes

Features:

EAB series conduit outlet boxes have:

- Five different hub configurations
- Taper threaded hubs to provide ground continuity
- Smooth integral hub bushing to protect conductor insulation when pulling
- Threaded cover openings
- Surface covers furnished with boxes
- Neoprene "o"-ring gasket and green ground screw are both standard.
- Four standard mounting pads, except for EABY.
- Cover threads are 16 pitch.

Certifications and Compliances:

- NEC/CEC:
 - Class I, Division 1 & 2, Groups A, B, C, D
 - Class II, Division 1, Groups E, F, G
 - Class II, Division 2, Groups F, G
 - Class III
- UL Standard: 1203
- CSA Standard: C22.2 No. 20

Standard Finishes:

- *Feraloy* – electrogalvanized and aluminum acrylic paint
- Aluminum – natural

Standard Materials:

- Bodies – *Feraloy*® iron alloy
- Covers – Copper-free aluminum

Options:

Description

Bodies – copper-free aluminum
 Covers – *Feraloy* iron alloy – electrogalvanized and aluminum acrylic paint
 Corro-free epoxy powder coat

Suffix
SA†*

WOD
S752

Size Ranges:

- Hub – 1/2" to 1"
- Cover opening – 3" dia.

EABC

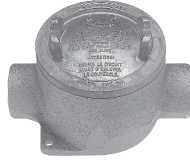

Hub Size	Cat. #
1/2	EABC16†
3/4	EABC26
1	EABC36†

EABT



Hub Size	Cat. #
1/2	EABT16†
3/4	EABT26†
1	EABT36†

EABL



Hub Size	Cat. #
1/2	EABL16†
3/4	EABL26†
1	EABL36†

Dimensions In Inches:

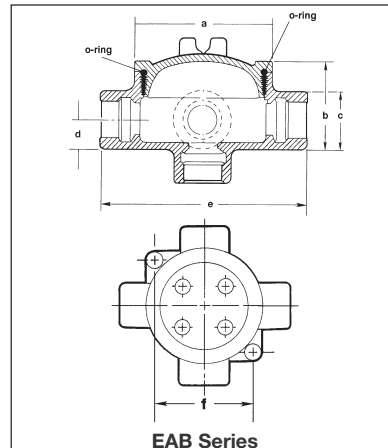

†Available in copper-free aluminum, add suffix -SA.
 *EAB0687 is listed for Group C & D only.

EABX

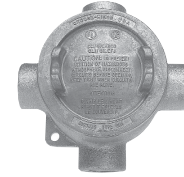

Hub Size	Cat. #
1/2	EABX16†
3/4	EABX26†
1	EABX36†

EABY



Hub Size	Cat. #
1/2	EABY16†
3/4	EABY26†

Replacement Cover:

Size	Cat. #
3"	EAB06

Replacement O-Ring:

Description	Cat. #
Replacement O-Ring	GASK1151

Fixture Cover Union Hub Type



Cover Opening Dia.	Fixt. Stem Size	Cat. #
3"	3/4	EAB0687*

EAB Series

Cat. #	a	b	c	d	e	f
16	3/4	2 ¹⁷ / ₃₂	1 1/2	3/4	5 ⁹ / ₁₆	3 ³ / ₃₂
26	3/4	2 ²⁹ / ₃₂	1 3/4	7/8	5 ⁹ / ₁₆	3 ³ / ₃₂
36	3/4	2 ²⁹ / ₃₂	1 3/4	7/8	5 ⁹ / ₁₆	3 ³ / ₃₂

Condulet® Conduit Outlet Boxes With Covers

EAB Series with UL, cUL and ATEX Certifications

Cl. I, Div. 1 & 2, Groups A, B, C, D
 Cl. II, Div. 1 & 2, Groups E, F, G
 II 2 G EEx d IIC T5
 PTB 05 ATEX 1052
 UL and cUL Listed

Explosionproof
 Dust-Ignitionproof
 Raintight
 Wet Locations
 Type 4 Enclosure / IP66

3F

Applications:

EAB ATEX series conduit outlet boxes are installed in conduit systems within hazardous areas to:

- Provide protection against exterior explosion where acetylene, hydrogen and other hazardous gases are present
- Protect conductors in threaded rigid conduit
- Act as pull and splice boxes
- Interconnect lengths of conduit
- Change conduit direction
- Provide access to conductors for maintenance and future system changes

Features:

EAB ATEX series conduit outlet boxes have:

- Two different hub configurations
- Taper threaded hubs to provide ground continuity
- Smooth integral hub bushing to protect conductor insulation when pulling
- Threaded cover openings
- Surface covers furnished with boxes
- Neoprene "o"-ring gasket and green ground screw are both standard.
- Cover threads are 16 pitch.

Certifications and Compliances:

- NEC/CEC:
 - Class I, Division 1 & 2, Groups A, B, C, D
 - Class II, Division 1 & 2, Groups E, F, G
 - Class III
 - II 2 G EEx d IIC T5
 - PTB 05 ATEX 1052
- UL Standard: 1203
- cUL Listed to CSA Standard: C22.2 No. 30
- Type 4 Enclosure
- IP66

Standard Materials:

- Bodies – *Feraloy*® iron alloy or copper-free aluminum
- Covers – Copper-free aluminum

Standard Finishes:

- *Feraloy* – electrogalvanized and aluminum acrylic paint
- Aluminum – natural

Options:

Description

Covers – *Feraloy* iron alloy – electrogalvanized and aluminum acrylic paint
Corro-free epoxy powder coat

Suffix to be added to Cat. #

WOD

S752

Size Ranges:

- Hub – 1/2" to 1"
- Cover opening – 3" dia.

EABX

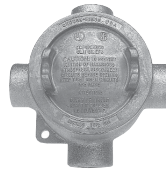

Hub Size	Body Material	Cat. # †
1/2	<i>Feraloy</i> ® Iron	EABX16 ATEX
1/2	Copper-free Aluminum	EABX16 SA ATEX
3/4	<i>Feraloy</i> ® Iron	EABX26 ATEX
3/4	Copper-free Aluminum	EABX26 SA ATEX
1	<i>Feraloy</i> ® Iron	EABX36 ATEX
1	Copper-free Aluminum	EABX36 SA ATEX

Dimensions In Inches:

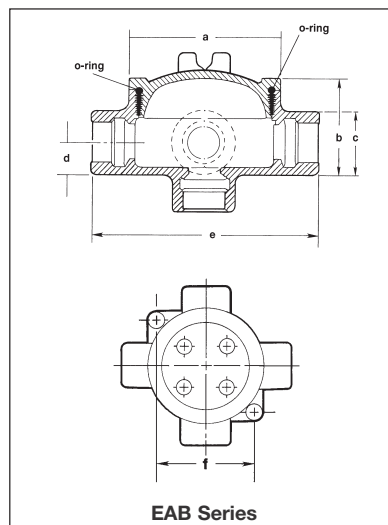

†Available with 6-point Phoenix MBK type terminal block mounted on DIN rail. Add suffix DIN16 before ATEX.
 Ordering example: EABX26 DIN16 ATEX
 *EAB0687 is listed for Group C & D only.

EABY



Hub Size	Body Material	Cat. # †
1/2	<i>Feraloy</i> ® Iron	EABY16 ATEX
1/2	Copper-free Aluminum	EABY16 SA ATEX
3/4	<i>Feraloy</i> ® Iron	EABY26 ATEX
3/4	Copper-free Aluminum	EABY26 SA ATEX

Replacement Cover:

Size	Cat. #
3"	EAB06

Replacement O-Ring:

Description	Cat. #
Replacement O-Ring	GASK1151

Fixture Cover Union Hub Type



Cover Opening Dia.	Fixt. Stem Size	Cat. #
3"	3/4"	EAB0687*

EAB Series

Cat. #	a	b	c	d	e	f
16	3/4	2 17/32	1 1/2	3/4	5 9/16	3 3/32
26	3/4	2 25/32	1 3/4	7/8	5 9/16	3 3/32
36	3/4	2 25/32	1 3/4	7/8	5 9/16	3 3/32

Condulet® Conduit Outlet Boxes With Covers

EAJ Series

Cl. I, Div. 1 & 2, Groups A†, B, C, D
 Cl. II, Div. 1, Groups E, F, G
 Cl. II, Div. 2, Groups F, G
 Cl. III
 NEMA 3, 4, 7ABCD, 9EFG

Explosionproof
 Dust-Ignitionproof
 Raintight
 Wet Locations

3F

Applications:

EAJ series conduit outlet boxes are installed in conduit systems within hazardous areas to:

- Protect conductors in threaded rigid conduit
- Act as pull and splice boxes
- Interconnect lengths of conduit
- Change conduit direction
- Provide access to conductors for maintenance and future system changes
- Act as mounting outlets for fixtures (with appropriate covers)
- Act as sealing fittings (with appropriate covers)

Features:

EAJ conduit outlet boxes have:

- Water shedding cover – suitable for wet locations when mounted in upright position
- External cover threads on body protecting conductors from damage during pulling
- No pinching of conductors during cover installation
- Six different hub arrangements
- Taper threaded hubs to provide ground continuity
- Smooth integral hub bushing to protect conductor insulation when pulling
- Internally threaded cover openings for additional wiring room
- Flat overlapping threaded covers furnished with boxes
- Weather-resistant finish
- Green ground screw standard in all boxes
- Four standard mounting pads, except for EAJB and EAJD

Certifications and Compliances:

- NEC/CEC:
 - Class I, Division 1 & 2, Groups A†,B,C,D
 - Class II, Division 1, Groups E,F,G
 - Class II, Division 2, Groups F,G
 - Class III
- UL Standard: 1203
- CSA Standard: C22.2 No. 30

Standard Materials:

- Body – *Feraloy*® iron alloy
- Cover – copper-free aluminum

Standard Finishes:

- *Feraloy* iron alloy – electrogalvanized and aluminum acrylic paint
- Aluminum – natural

Options:

Description	Suffix
Bodies – copper-free aluminum	SA†
Covers – <i>Feraloy</i> iron alloy – electrogalvanized and aluminum acrylic paint	WOD
Corro-free epoxy powder coat	S752

Size Ranges:

- Hub – 1/2" to 2"
- Cover opening – 3 3/16" to 5" dia.

EAJB

Cover Opening Dia.	Hub Size	Cat. #
3 3/16	1/2	EAJB16†
3 3/16	3/4	EAJB26†
3 3/16	1	EAJB36†

EAJC

Cover Opening Dia.	Hub Size	Cat. #
3 3/16	1/2	EAJC16†
3 3/16	3/4	EAJC26†
3 3/16	1	EAJC36†

EAJD

Cover Opening Dia.	Hub Size	Cat. #
3 3/16	1/2	EAJD16†
3 3/16	3/4	EAJD26†
3 3/16	1	EAJD36†

EAJL

Cover Opening Dia.	Hub Size	Cat. #
3 3/16	1/2	EAJL16†
3 3/16	3/4	EAJL26†
3 3/16	1	EAJL36†

EAJT

Cover Opening Dia.	Hub Size	Cat. #
3 3/16	1/2	EAJT16†
3 3/16	3/4	EAJT26†
3 3/16	1	EAJT36†
5	1 1/4	EAJT49††
5	1 1/2	EAJT59††
5	2	EAJT69††

EAJX

Cover Opening Dia.	Hub Size	Cat. #
3 3/16	1/2	EAJX16†
3 3/16	3/4	EAJX26†
3 3/16	1	EAJX36†

EAJ Threaded Covers



Flat Covers

Cover Opening Dia.	Cat. #
3 3/16	EAJ06
5	EAJ09

Dome Covers



Cover Opening Dia.	Depth	Cat. #
3 3/16	2	EAJ0612

Fixture Covers



Union Hub Type			
Cover Opening Dia.	Fixt. Stem Size	Cat. #	
3 3/16	3/4	EAJ0687*	

Dimensions In Inches:

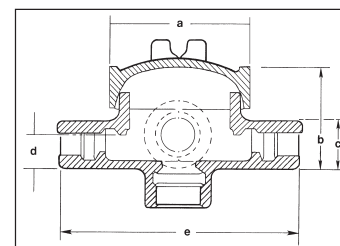

Cat. #	a	b	c	d	e	f
16	3 3/4	2 17/32	1 1/2	3/4	5 5/16	3 3/32
26	3 3/4	2 25/32	1 3/4	7/8	5 9/16	3 3/32
36	3 3/4	2 29/32	1 3/4	7/8	5 9/16	3 3/32
49	5 3/4	4 1/16	2 3/16	1 3/32	7 5/16	4 3/4
59	5 3/4	4 1/16	3	1 1/2	7 13/16	4 3/4
69	5 3/4	4 1/16	3	1 1/2	7 13/16	4 3/4

*EAJ0687 is listed for Group C & D only.
 †Available in copper-free aluminum, add suffix -SA.
 ‡Form 9 products with 5" cover opening are not suitable for Group A.

Condulet® Conduit Outlet Boxes With Covers

Ex II 2 G EEx d IIC T6
Ex II 2 D IP66 T 85°C

Zone 1, 2, 21 and 22

3F

for IEC Applications

Applications:

C30 and C31 series conduit outlet boxes are installed in electrical systems within hazardous areas to:

- Provide protection against exterior explosion where acetylene, hydrogen and other hazardous gases are present
- Protect conductors in threaded rigid conduit
- Act as pull and splice boxes
- Interconnect lengths of conduit
- Change conduit direction
- Provide access to conductors for maintenance and future system changes

Features:

C30 and C31 series conduit outlet boxes have:

- Taper threaded hubs to provide ground continuity
- Smooth integral hub bushing to protect conductor insulation when pulling
- Threaded cover openings
- Surface covers furnished with boxes
- Neoprene "o"-ring gasket and green ground screw are both standard
- Cover threads are 16 pitch

Certifications and Compliances:

- IEC:
 - Ex d IIC T6
 - Ex tD A21 IP67 T85°C
 - EC-Type examination certificate LOM 02 ATEX 2037 X
 - Compliant to EN60079-0
- IP67

Standard Materials:

- Bodies – Light alloy, natural finish
- Covers – Light alloy, natural finish

Technical Specifications

Operating temperature range	-50°C to +55°C
Degree of protection	IP67
Rated voltage	up to 690V
Rated current	Acc. terminals
Terminals	C30 Series: up to 6mm ² C31 Series: up to 10 mm ²

C30 Series



C31 Series

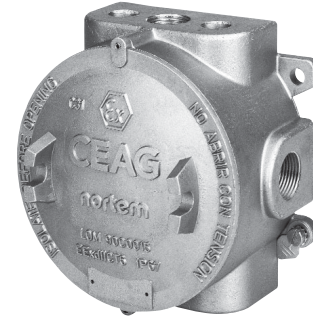

Ordering Information

Series	Shape	Hub Size	Cat. # †
C30	T	3 x 1/2"	NOR 000 001 151 181
C30	T	3 x 3/4"	NOR 000 001 151 199
C30	X	4 x 1/2"	NOR 000 001 151 206
C30	X	4 x 3/4"	NOR 000 001 151 214
C31	T	3 x 1/2"	NOR 000 111 150 001
C31	T	3 x 3/4"	NOR 000 111 150 002
C31	T	3 x 1"	NOR 000 111 150 003
C31	X	4 x 1/2"	NOR 000 111 150 004
C31	X	4 x 3/4"	NOR 000 111 150 005
C31	X	4 x 1"	NOR 000 111 150 006

Accessories

Description	Cat. #
C30 Mounting plate with pillar terminals 4 x 4mm ²	NOR 000 001 151 222
C30 support rail DIN 46877	NOR 000 000 115 314
C30 mounting plate without terminals	NOR 000 000 115 302
C30 pending support	NOR 000 000 115 311
C31 mounting plate with pillar terminals 4 x 4mm ²	NOR 000 111 150 009
C31 mounting plate without terminals	NOR 000 000 115 306
C31 support rail DIN 46877	NOR 000 000 115 315

Dimensions

In Inches:

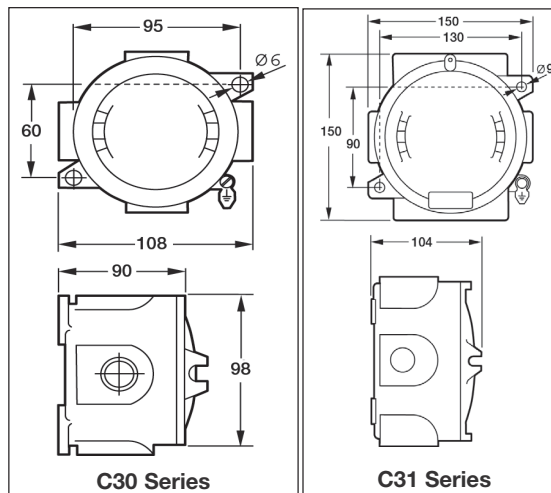

†Other entries available upon request.

Condulet® Conduit Outlet Boxes With Covers

CPS Series

Cl. I, Div. 1 & 2, Groups C, D
 Cl. II, Div. 1, Groups E, F, G
 Cl. II, Div. 2, Groups F, G
 Cl. III
 NEMA 7CD,9EFG

Explosionproof
 Dust-Ignitionproof

3F

Applications:

CPS series conduit outlet boxes are installed in conduit systems in hazardous areas to:

- Protect conductors in threaded rigid conduit
- Act as pull and splice boxes
- Change conduit direction
- Interconnect lengths of conduit
- Act as fixture hangers with hub covers
- Provide access to conductors for maintenance and future system changes

Features:

CPS conduit outlet boxes have:

- Two types of cover:
 - blank for splice or pull box use
 - threaded hub for mounting light fixtures
- Wide, accurately machined body and cover mating surfaces, to insure flamtight joint
- Blind tapped holes for cover screws to further insure flamtightness
- Removable mounting feet for flush or surface mounting to wall or ceiling

Certifications and Compliances:

- NEC/CEC
 - Class I, Division 1 & 2, Groups C, D
 - Class II, Division 1, Groups E, F, G
 - Class II, Division 2, Groups F, G
 - Class III
- UL Standard: 1203
- CSA Standard C22.2 No. 30

Standard Materials:

- Feraloy® iron alloy

Standard Finishes:

- Electrogalvanized and aluminum acrylic paint

Options:

Description	Suffix
Corro-free™ epoxy powder coat	S752

Box with Hub Cover

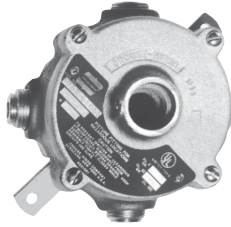

Hub Size	Cover	Cat. #
3/4	1/2	CPS12021
3/4	3/4	CPS12022

‡Furnished with four 3/8" standard taper tapped, integrally bushed hubs. Three hubs are plugged.

Box with Blank Cover

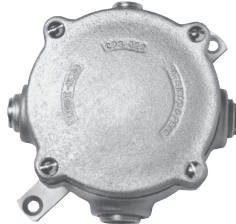

Hub Size	Cat. #
3/4	CPS12026

CPS Covers



Blank Covers

Description	Cat. #
Form 20	CPS026

Hub Covers*

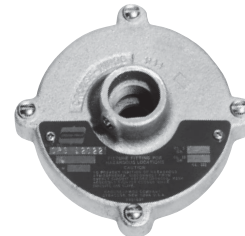

Description	Hub Size	Cat. #
Form 20	1/2	CPS021
Form 20	3/4	CPS022

*Fixture weight up to 125 lbs.

Dimensions

In Inches:

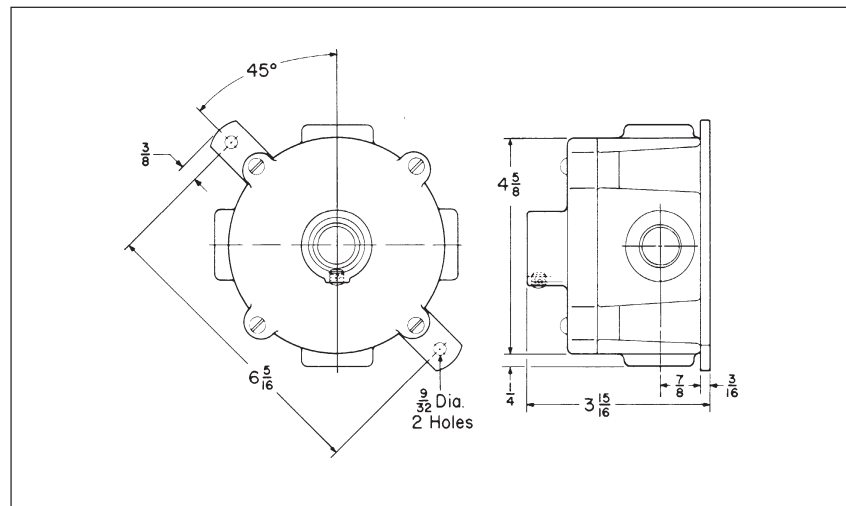

Complete line of fixture hangers are located in section 7L of this catalog.

Condulet® Conduit Bodies With Covers

OE Series

Cl. I, Div. 1 & 2, Groups C, D
 Cl. II, Div. 1, Groups E, F, G
 Cl. II, Div. 2, Groups F, G
 Cl. III
 NEMA 7CD, 9EFG

Explosionproof
 Dust-Ignitionproof

3F

3F

Applications:

OE series are installed in conduit systems within hazardous areas to:

- Protect conductors in threaded rigid conduit
- Act as pulling and splice fittings
- Interconnect lengths of conduit
- Change direction of conduit
- Provide access for maintenance and future system changes

Features:

OE conduit outlet bodies have:

- Taper threaded hubs for ground continuity
- Smooth integral hub bushings to protect conductor insulation when pulling
- Five different hub arrangements
- Accurately machined body with blind tapped screw holes
- Most compact design of all hazardous area outlet bodies

Certifications and Compliances:

- NEC/CEC:
 - Class I, Division 1 & 2, Groups C, D
 - Class II, Division 1, Groups E, F, G
 - Class II, Division 2, Groups F, G
 - Class III
- UL Standard: 1203
- CSA Standard: C22.2 No. 30

Standard Materials:

- Feraloy® iron alloy (1/2" and 3/4" fittings)
- Copper-free aluminum (1" fittings)

Standard Finishes:

- Electrogalvanized and aluminum acrylic paint

Options:

Description Corro-free™ epoxy powder coat
Suffix S752

Size Ranges:

- Hub - 1/2" to 1"

OEC



Hub Size	Cat. #
1/2	OEC1
3/4	OEC2
1	OEC3 SA

OET

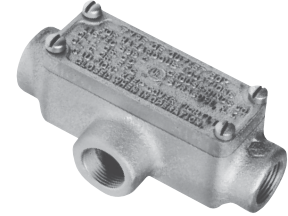

Hub Size	Cat. #
1/2	OET1
3/4	OET2
1	OET3 SA

OELL

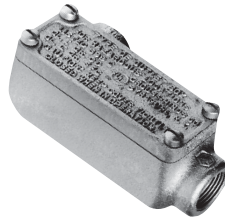

Hub Size	Cat. #
1/2	OELL1
3/4	OELL2
1	OELL3 SA

OELB

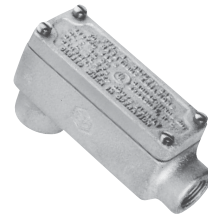

Hub Size	Cat. #
1/2	OELB1
3/4	OELB2
1	OELB3 SA

OELR

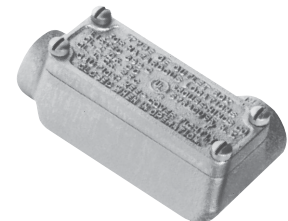

Hub Size	Cat. #
1/2	OELR1
3/4	OELR2
1	OELR3 SA

Dimensions In Inches:

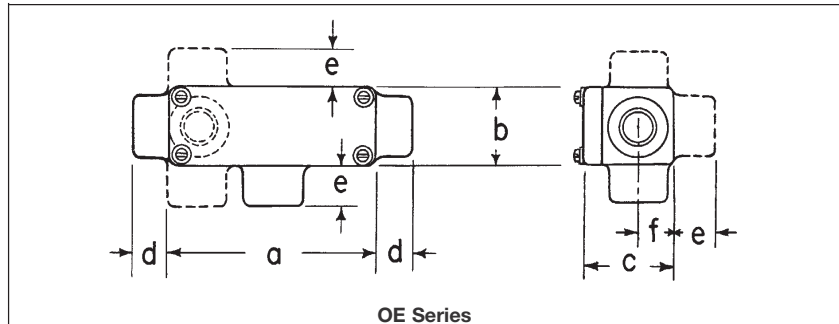

Hub Size in.	a	b	c	d	e	f
1/2	4 1/16	1 9/16	1 13/16	1 1/16	7/8	3/8
3/4	4 5/16	1 7/8	2 1/16	1 1/16	7/8	3/4

3F Condulet® Conduit Bodies With Covers

EKC Series

Cl. I, Div. 1 & 2, Groups C, D Explosionproof
 Cl. II, Div. 1, Groups E, F, G Dust-Ignitionproof
 Cl. II, Div. 2, Groups F, G
 Cl. III
 NEMA 7CD,9EFG

3F

Applications:

EKC series conduit outlet bodies are installed in conduit systems within hazardous areas to:

- Provide convenient opening in conduit system for pulling or splicing conductors

Features:

EKC bodies have:

- Accurately machined body and cover mating surfaces to ensure flamtight joint when properly assembled
- Extra long cover opening to facilitate pulling and splicing of conductors
- Taper threaded hubs and integral bushing for rigid threaded conduit

Certifications and Compliances:

- NEC:
 - EKC 30 – 60
 - Class I, Division 1 & 2, Groups C, D
 - Class II, Division 1, Groups E, F, G
 - Class II, Division 2, Groups F, G
 - Class III
- EKC 70, 80
- Class I, Division 1 & 2, Group D
- Class II, Division 1, Groups E, F, G
- Class II, Division 2, Groups F, G
- Class III
- UL Standard: 1203
- CSA Standard: C22.2 No. 30

Standard Materials:

- EKC bodies – *Feraloy* iron alloy

Standard Finishes:

- *Feraloy* – electrogalvanized and aluminum acrylic paint

Options:

Description	Suffix
EKC series:	
<i>Corro-free</i> ™ epoxy powder coat	S752

Size Ranges:

- EKC bodies – hub size – 1" to 3"

Ordering Information



EKC

Hub Size	Cat. #
1	EKC30
1¼	EKC40
1½	EKC50
2	EKC60
2½	EKC70
3	EKC80

Dimensions In Inches:

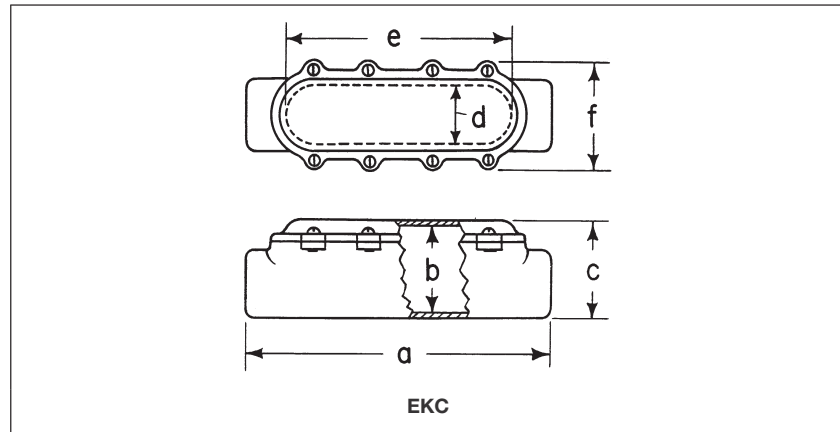

EKC

Size	a	b	c	d	e	f
1 – 1¼	12 ⁵ / ₁₆	3 ¹ / ₁₆	3 ⁷ / ₁₆	1 ³ / ₄	9	4
1½ – 2	15 ¹⁵ / ₁₆	3 ⁷ / ₈	4 ⁵ / ₁₆	2 ¹ / ₂	12	5
2½ – 3	21 ³ / ₄	5 ¹ / ₂	6	3 ³ / ₄	16	6 ⁵ / ₈

Condulet® Conduit Bodies With Covers; Elbows and Tees

LBH, LBY, ET Series

Cl. I, Div. 1 & 2, Groups A, B, C, D*
Cl. II, Div. 1, Groups E, F, G
Cl. II, Div. 2, Groups F, G
Cl. III
NEMA 7ABCD,9EFG

Explosionproof
Dust-Ignitionproof

3F

Applications:

LBH conduit outlet bodies are installed in hazardous areas to:

- Act as pull outlets especially for conductors that are stiff due to large size or type of insulation
- Make 90° bends in conduit system, allowing straight pull in either direction
- Provide for conduit service entrance to buildings
- Provide for conductor entrance to motors
- Provide access to wiring for maintenance and future system changes

LBY elbows are installed in conduit systems within hazardous areas to:

- Make 90° bends in conduit systems where space is limited
- Act as pull outlets
- Provide access to conductors for maintenance and future system changes

ET series short radius tees are installed in conduit systems within hazardous areas to:

- Allow single conduit stub up to outlet and device boxes located above or below main conduit runs. Eliminates separate feed and return conduits

Features:

LBH bodies have:

- Cover openings on an angle, permitting conductors to be pulled straight through hubs from either direction
- Domed covers to permit easy conductor bends (relieves strain on insulation)
- Taper threaded hubs with integral bushings

LBY elbows have:

- Maximum volume for bends within a compact overall size
- Screw on cover for ease of installation and removal
- Over opening on an angle, permitting conductors to be pulled straight through either hub
- Taper threaded hubs and integral bushing for rigid threaded conduit

ET short radius tees have:

- Compact size and small radius of bend for use in concealed, or open conduit systems.
- Particularly suited for use in shallow floors or partitions
- Taper threaded hubs and integral bushing for rigid threaded conduit

Certifications and Complies:

- NEC:
 - LBH 10-20 –
 - Class I, Division 1 & 2, Groups B, C, D
 - Class II, Division 1, Groups E, F, G
 - Class II, Division 2, Groups F, G
 - Class III
 - LBH 30-100
 - Class I, Division 1 & 2, Group D
 - Class II, Division 1, Groups E, F, G
 - Class II, Division 2, Groups F, G
 - Class III
 - LBY –
 - Class I, Division 1 & 2, Groups C, D
 - Class II, Division 1, Groups E, F, G
 - Class II, Division 2, Groups F, G
 - Class III
 - ET –
 - Class I, Division 1 & 2, Groups A, B, C, D
 - Class II, Division 1, Groups E, F, G
 - Class II, Division 2, Groups F, G
 - UL Standard: 1203
 - CSA Standard: C22.2 No. 30

Standard Materials:

- LBH, LBY and ET – *Feraloy*® iron alloy

Standard Finishes:

- LBH, LBY and ET – electrogalvanized and aluminum acrylic paint

Dimensions In Inches:

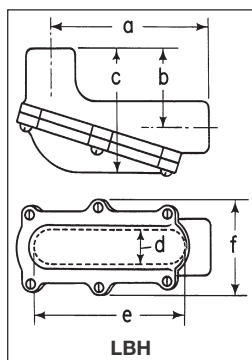

LBH

Size	a	b	c	d	e	f
1/2-3/4	5 1/16	2 19/32	4	1 9/16	4	2 3/4
1-1/4	7 7/8	3 13/32	5 1/4	1 3/4	7	4
1 1/2	10 15/16	4 1/2	7 3/32	2 1/2	10	5
2	10 21/32	4 25/32	7 3/32	2 1/2	10	5
2-1/2-3	15 5/8	5 1/2	9 1/2	3	15 3/4	5 5/8
3-1/2-4	23 3/16	6 11/16	11 3/4	4	24	7 1/8

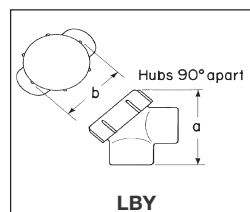

LBY

Size	a	b
1/2	2 9/16	2
3/4	2 13/16	2 1/4
1	3 3/32	2 1/2
1 1/4	3 3/4	2 15/16
1 1/2	4 1/4	3 3/8

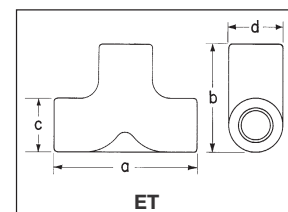

ET

Size	a	b	c	d
3/4-1/2-1/2	4	2 5/8	1 1/4	1 1/2
3/4-3/4-3/4	4	3	1 1/2	1 1/2
1-3/4-3/4	4	3	1 1/2	1 3/4

Options:

Description	Suffix
LBH and LBY series – copper-free aluminum	SA
LBH and LBY series – <i>Corro-free</i> ™ epoxy powder coat	S752

Size Ranges:

- LBH bodies – hub size 1/2" to 4"
- LBY elbows – hub size 1/2" to 1 1/2"

Ordering Information

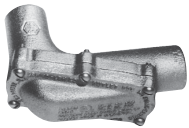
LBH	Hub Size	Cat. #
	1/2	LBH10
	3/4	LBH20
	1	LBH30
	1 1/4	LBH40
	1 1/2	LBH50
	2	LBH60
	2 1/2	LBH70
	3	LBH80
	3 1/2	LBH90
	4	LBH100

LBY	Hub Size	Cat. #
	1/2	LBY15
	3/4	LBY25
	1	LBY35
	1 1/4	LBY45
	1 1/2	LBY55

ET	Hub Size	Cat. #
	3/4-1/2-1/2 ‡	ET218
	3/4-3/4-3/4 ‡	ET228
	1-3/4-3/4 ‡	ET328

‡Largest hub is shown at top of photo.

FE and FT Series

3F

Applications:

FE and FT conduit fittings are installed in hazardous areas to:

- Act as draw-in outlets especially for cables that are stiff due to large size or type of insulation
- Make 90° bends in conduit systems, allowing for a straight pull in either direction
- Provide access to wiring for maintenance and future system changes

Features:

- Maximum volume for bends within a compact overall size
- Large openings to facilitate cable pulling

Certifications and Compliances:

Type of Protection

- Ex d, DIP A21, IP67

Degree of Protection

- IP67

Gas Group

- IIB

Approvals

- Ex1108U

Standard Materials:

- Body – Copper-free aluminum
- Cover – Brass

Standard Finishes:

- Natural

Options:

Description **Suffix**
NPT & BSP thread sizes **Consult Factory**

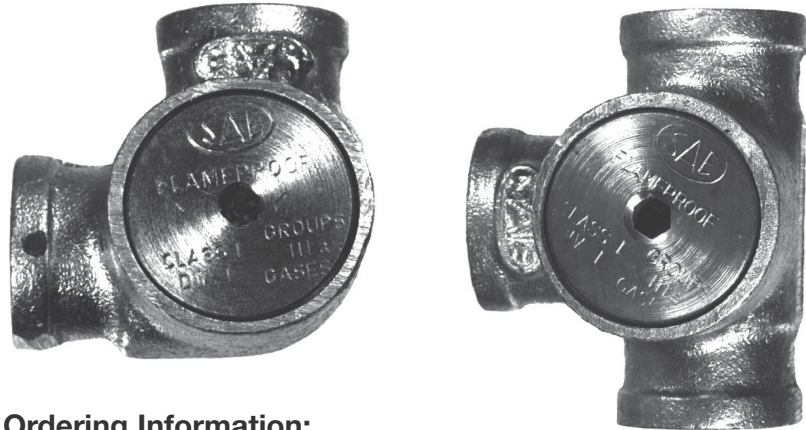

Ordering Information:
Inspection Elbows and Tees Selection

Cat. #	Type	Entry Size (metric)
FE1	Elbow	M20 (F)-M20 (F)
FE2	Elbow	M25 (F)-M25 (F)
FT1	Tee	M20 (F)-M20 (F)
FT2	Tee	M25 (F)-M25 (F)

Dimensions (mm)

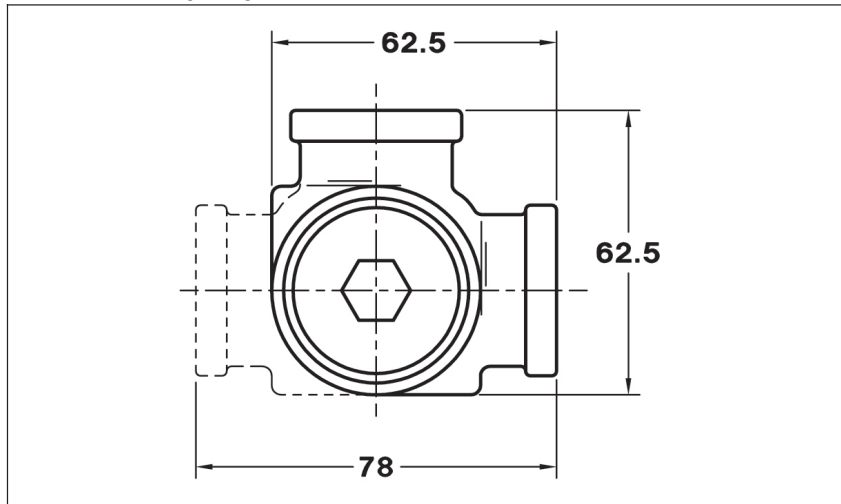

Applications:

- STL thread lubricant is used between any screw thread and its tapped opening, on any rotating shaft – threaded or plain, and to inhibit corrosion on any metal-to-metal joint of apparatus and control enclosures.
- HTL high temperature lubricant is used on lighting fixture threaded joints and on threaded joints of the enclosures of any heat-producing apparatus or control.

Certifications and Compliances:

- Complies with NEC 2008, Article 300.6

Features:

STL thread lubricant is lithium based, antigalling and:

- Is especially effective between parts made of dissimilar metals
- Is effective and stable from -20°F to +300°F
- Maintains grounding continuity; should not be used on exposed current-carrying parts
- Has excellent adhesion qualities; a liberal application on threaded joints maintains raintightness and inhibits corrosion

HTL is a high temperature, anti-seize, conductive thread lubricant:

- Effective and stable from -70°F to +1800°F
- Prevents seizure, galling, rust, galvanic action
- Maintains grounding continuity; should not be used on exposed current-carrying parts
- Effective between parts made of dissimilar metals

STL Thread Lubricant



Net Wt.	Cat. #
1 3/4 oz. (tube)	STL2
8 oz. (can)	STL8

HTL High Temperature Thread Lubricant



Net Wt.	Cat. #
4 oz. (tube)	HTL4

MSDS Sheets are available at www.crouse-hinds.com

3F

3F



Description	Page No.	Description	Page No.
Application	see page 66	Cable Glands - Accessories	
Cable Glands - International Standards		A Series	see page 96
Quick Selection Guide	see pages 67–70	B Series	see page 100
Flameproof and Increased Safety		D Series	see page 101
ADE 1F	see page 71	E Series	see page 102
ADE 4F	see page 72	Breathers and Drains	see page 103
ADE 6F	see page 73	Cable Tray Clamps	
ADE 6FC	see page 74	Conduit	
ADE 1FC	see page 75	LCC, LCCF Series	see page 104
Ex - e	see page 76	Grounding Conductor	
Ex - i	see page 77	TGC Series	see page 105
Trumpet	see page 78	Cable/Conduit Sealing Devices	
Enlargement and Multiple	see page 79	Thru-Wall Barrier®	
Industrial		TW Series	see pages 106–107
ADE 4I	see page 80	Link Seal – For Conduit	
Cable Glands - North American Standards		Environmental Seal	see pages 112–113
Quick Selection Guide	see pages 67–70	Fire Seal	see pages 114–115
Explosionproof			
Terminator™ II TMCX	see pages 81–82		
TMCX	see page 83		
ADE 6FC	see page 84		
ADE 1FC	see page 85		
CGBS	see page 86		
EBY	see page 86		
General Purpose			
TMC	see page 87		
TECK	see page 88		
CGB	see pages 89–90		
CGD	see page 91		
CGE	see page 92		
CGB1013	see page 93		
CGFP	see page 94		
NCG	see page 95		
NCGB	see page 95		



Application and Selection

Applications:

Cable glands and cord fittings:

- Provide means for passing a cord, cable (armored or unarmored) or flexible conduit into an enclosure, through a bulkhead or into a rigid conduit
- Form a mechanical grip and water and/or oil-resistant seal for cord and unarmored or jacketed armored, round cables
- Form a non-slip connection or termination for flexible cord, cable (armored or unarmored), or flexible conduit
- Provide grounding continuity for cable armor and flexible conduit

Cable glands with sealing fitting or epoxy are installed to:

- Provide means for passing armored, metal clad, jacketed or unjacketed and unarmored cables through a bulkhead or enclosure in hazardous areas. These fittings are suitable for use in Class I, Groups C, D locations only when Chico® A sealing compound or TSC epoxy (TMCX) is used to make the seal in the fitting*
- Form a mechanical grip and water and/or oil-resistant termination
- Provide ground continuity of cable armor and flexible conduit

TMC (non-hazardous) and TMCX (hazardous) fittings are designed for use with Type MC jacketed steel or aluminum metal clad cables with interlocked or corrugated armor and Type TC tray cable (TMCX).

LCC cable tray conduit clamps are used for installation on cable tray side rails with inside flanges (requiring inside tray mounting) and outside flanges; LCCF clamps are for use exclusively on inside flanges. LCC/LCCF series cable tray conduit clamps are installed to:

- Provide a means of clamping metal conduit (rigid steel or aluminum, IMC and EMT) to cable tray for the exit of power and/or control cables from tray
- Provide a means to firmly bond exiting conduit to cable tray for best grounding continuity

TW Series THRU-WALL BARRIER® cable/conduit sealing devices are installed to:

- Seal cables or conduits penetrating fire rated walls, ceilings, or floors
- Restrict entrance of water and dust and contain treated air
- Provide a seal for cable/conduit penetrations through steel, masonry or concrete; to restrict the entrance of contaminants through cable/conduit penetrations into clean areas









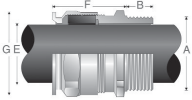

TGC cable tray grounding conductor clamp provides a means for securely attaching a grounding conductor to cable tray to provide grounding continuity for the entire tray system. TGC cable tray grounding conductor clamps provide a reliable method for carrying ground fault current for equipment protection. TGC clamp may be installed on most types of cable trays – with inside or outside flanges.

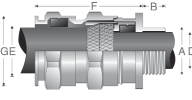
Considerations for Selection:

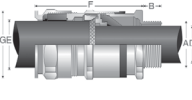
- Selection of the proper cable gland involves consideration of the type of cable to be installed and the environment that will surround the cable after installation.
- A proper matching of the cable and its gland is necessary to prevent physical damage to the cable when installed. Some types of cable glands depend on gripping methods (set screws, etc.) which may lead to damage of the cable outer covering. Eaton's Crouse-Hinds cable glands and cord fittings utilize compression of split lead or tapered neoprene bushings to provide high gripping strength for adequate cable support and strain relief without damage to the cable sheath.
- Compression of bushing provides a strong electrical bond that assures grounding continuity.
- Compression of a tapered neoprene bushing assures the watertight integrity of Eaton's Crouse-Hinds cable glands. Additional watertightness, to prevent water seepage into the fitting body, can be obtained by use of a potting head filled with a hot pouring compound.
- To meet National Electrical Code requirements for electrical installations in hazardous atmospheres, a sealing fitting may be required in conjunction with the cable or cord fitting.

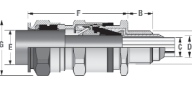
*With specific cords and cables when installed in accordance with NEC/CEC requirements.

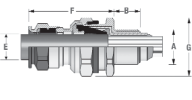
Quick Selection Guide - International Standards









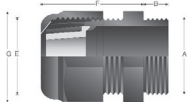

CABLE GLAND	ILLUSTRATION	CABLE TYPE	GLAND TYPE	STANDARD MATERIAL	CERTIFICATION	PROTECTION TYPE
ADE 1F (see page 71)		Non-armoured, armoured and tray cable (does not terminate the armour)	Non-armoured	Nickel-plated brass		Flameproof & Increased Safety
ADE 4F (see page 72)		SWA, SWB, STA, braided marine shipboard and lead sheathed (with addition of earthing washer)	Armoured	Nickel-plated brass		Flameproof & Increased Safety
ADE 6F (see page 73)		SWA, SWB, STA and braided marine shipboard	Armoured	Nickel-plated brass		Flameproof & Increased Safety
ADE 6FC (see page 74)		SWA, SWB, STA, braided marine shipboard and lead sheathed (with addition of earthing washer)	Armoured barrier	Nickel-plated brass		Flameproof & Increased Safety
ADE 1FC (see page 75)		Non-armoured, armoured and tray cable (does not terminate the armour)	Non-armoured barrier	Nickel-plated brass		Flameproof & Increased Safety

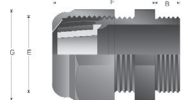
4F

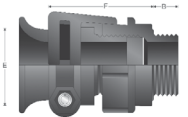
4F Global Cable Glands

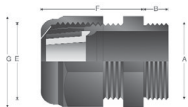
Quick Selection Guide - International Standards

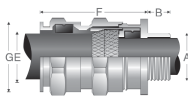
4F

CABLE GLAND	ILLUSTRATION	CABLE TYPE	GLAND TYPE	STANDARD MATERIAL	CERTIFICATION	PROTECTION TYPE
Ex - e (see page 76)		Non-armoured	Non-armoured	Polyamide		Increased Safety
Ex - i (see page 77)		Non-armoured	Non-armoured	Polyamide		Increased Safety
Trumpet (see page 78)		Non-armoured	Non-armoured	Polyamide		Increased Safety
Enlargement and Multiple (see page 79)		Non-armoured	Non-armoured	Polyamide		Increased Safety
ADE 4I (see page 80)		SWA, SWB, STA, braided marine shipboard and lead sheathed (with addition of earthing washer)	Armoured	Nickel-plated brass		Industrial

Quick Selection Guide - North American Standards











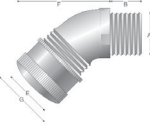

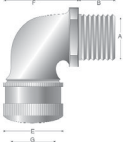
CABLE GLAND	ILLUSTRATION	CABLE TYPE	GLAND TYPE	STANDARD MATERIAL	CERTIFICATION	PROTECTION TYPE
Terminator™ II TMCX X (see pages 81–82)		Metal-clad, TECK (interlocked and continuously welded corrugated armoured), unarmoured, and tray cable	Armoured barrier, non-armoured barrier, and TECK armoured	Aluminum	UL UL US LISTED	Explosionproof
TMCX (see page 83)		Metal-clad with interlocked or continuously welded corrugated, TECK armoured, non-armoured and tray cable	Armoured barrier and non-armoured barrier	Aluminum	UL SP	Explosionproof
ADE 1FC (see page 85)		Non-armoured, armoured and tray cable (does not terminate the armour)	Non-armoured barrier	Nickel-plated brass	IECEX CE C/CEPEL UL US LISTED	Flameproof & Increased Safety
ADE 6FC (see page 84)		SWA, SWB, STA, braided marine shipboard and lead sheathed (with addition of earthing washer)	Armoured barrier	Nickel-plated brass	IECEX CE C/CEPEL UL US LISTED	Flameproof & Increased Safety
CGBS (see page 86)		Non-armoured and tray cable	Portable cord connector	Body: steel Gland nut: aluminum	SP	Explosionproof
EBY (see page 86)		Non-armoured	Portable cord connector	Aluminum	UL US LISTED	Explosionproof
TMC (see page 87)		Metal-clad with interlocked or continuously welded corrugated, TECK armoured, non-armoured and tray cable	Armoured or non-armoured	Aluminum	UL US LISTED	General Purpose
TECK (see page 88)		TECK armoured	Armoured	Aluminum	SP	General Purpose
CGB (see pages 89–90)		Non-armoured and tray cable	Non-armoured	Body steel Form A-D steel Form E-F iron	UL US LISTED	General Purpose

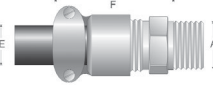
4F

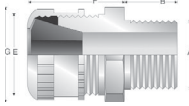
4F Global Cable Glands

Quick Selection Guide - North American Standards

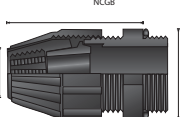
4F

CABLE GLAND	ILLUSTRATION	CABLE TYPE	GLAND TYPE	STANDARD MATERIAL	CERTIFICATION	PROTECTION TYPE
CGD (see page 91)		Non-armoured and tray cable	Non-armoured	Body: iron Gland nut: steel		General Purpose
CGE (see page 92)		Non-armoured and tray cable	Non-armoured	Body: iron Gland nut: steel		General Purpose
CGB1013 (see page 93)		Non-armoured and tray cable	Portable cord connector	Body: steel Gland nut: aluminum		General Purpose
CGFP (see page 94)		Non-armoured and tray cable	Non-armoured	Form B-C: steel Form D-G: iron		General Purpose
NCG (see page 95)		Non-armoured and tray cable	Non-armoured	Polyamide		General Purpose
NCGB (see page 95)		Non-armoured and tray cable	Non-armoured	Thermoplastic polyester		General Purpose

ADE 1F

International Standards - Flameproof and Increased Safety

ATEX
IECEX
cULus Listed for Class I, Zone 2
cULus Marine Listed for Class I, Zone 2

CEPEL
GOST-R
NEPSI
NEMA 4X and IP68

4F

Gland Type:

Non-armoured

Cable Type:

Non-armoured, armoured and tray cable (does not terminate the armour)

Certifications and Compliances:

- ATEX LCIE 97 ATEX 6008X – Exd IIC/Exe II/Ex tD /Ex II 2 GD
- IECEX LCI 05.0004X
- cULus Listed for Class I Zone 2 AEx e II/Ex e II E310130
- cULus Marine Listed for Class I Zone 2 AEx e II/Ex e II E314047
- NEMA 4X and IP68
- CEPEL cepel-EX-558/05X
- GOST-R POCC FR.B02011
- NEPSI N° GYJ071336U & GYJ071337U

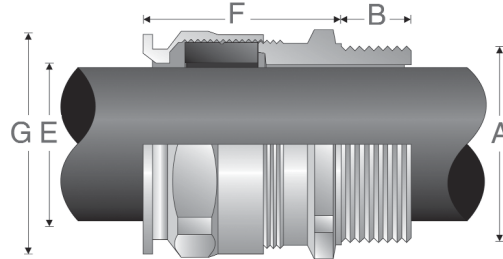

Features:

- Standard material is nickel-plated brass for superior corrosion resistance
- Provides a flameproof and weatherproof seal on the outer sheath of the cable
- Standard neoprene seal suitable for use in operating temperatures ATEX (-60°C to 100°C), IECEX and cULus (-40°C to 100°C)
- Available with optional silicone seal for extreme temperatures
- Available with metric or NPT threads
- See pages 96–103 for related accessories

ORDERING EXAMPLE:	OPTIONS (replace last digit with option number):
<div style="border: 1px solid black; padding: 5px; display: inline-block;"> CAP81640 4 KX </div>	9 Stainless steel (316L) 8 Bronze 7 Aluminum 5 Silicone sealing ring with temperature range of -70°C to 220°C K1 Includes locknut and fiber washer K2 Includes locknut, fiber washer, earth tag, and shroud
Gland Type	Options

SELECTION TABLE

Gland Size	Entry Thread Size 'A'				Thread Length 'B' Metric (NPT)	Cable Acceptance Outer Sheath 'E'		Gland Length 'F' (less entry)	Hexagon Dimensions	
	Metric Size	Metric Catalog #	NPT Size	NPT Catalog #		Min	Max		Across Flats	Across Corners 'G'
4	M12	CAP816404	1/4"	CAP818404	15 (12.0)	4.0	8.0	20	-	16.5
4	M16	CAP816594	3/8"	CAP818594	15 (12.0)	4.0	8.5	20	-	20.9
5	M16	CAP816504	1/2"	CAP818694	15 (12.0)	6.0	12.0	22	-	20.9
4	M20	CAP816674	1/2"	CAP818674	15 (20.2)	4.0	8.5	20	-	26.4
5	M20	CAP816694	1/2"	CAP818694	15 (20.2)	6.0	12.0	22	-	26.4
6	M20	CAP816604	1/2"	CAP818604	15 (20.2)	8.5	16.0	25	-	26.4
5	M25	CAP816774	3/4"	CAP818774	15 (20.2)	6.0	12.0	22	-	33
6	M25	CAP816794	3/4"	CAP818794	15 (20.2)	8.5	16.0	25	-	33
7	M25	CAP816704	3/4"	CAP818704	15 (20.2)	12.0	21.0	27	-	33
7	M32	CAP816894	1"	CAP818894	15 (25.3)	12.0	21.0	27	-	39.6
8	M32	CAP816804	1"	CAP818804	15 (25.3)	16.0	27.5	34	-	45.1
8	M40	CAP816994	1 1/4"	CAP818994	15 (26.0)	16.0	27.5	34	-	48.4
9	M40	CAP816904	1 1/4"	CAP818904	15 (26.0)	21.0	34.0	36	-	52.8
9	M50	CAP817094	1 1/2"	CAP819094	15 (26.5)	21.0	34.0	36	-	60.5
10	M50	CAP817004	1 1/2"	CAP819004	15 (26.5)	27.0	41.0	39	-	60.5
11	M63	CAP817294	2"	CAP819294	17 (27.2)	33.0	48.0	41	-	73.7
12	M63	CAP817204	2"	CAP819204	17 (27.2)	40.0	56.0	43	-	79.2
12	M75	CAP817394	2 1/2"	CAP819494	18 (40.5)	40.0	56.0	43	-	88
13	M75	CAP817304	2 1/2"	CAP819404	18 (40.5)	47.0	65.0	49	-	93.5
14	M90	CAP817594	3"	CAP819594	22 (42.0)	54.0	74.0	56	-	104.5
15	M90	CAP817504	3"	CAP819504	22 (42.0)	63.0	78.0	61	-	121
16	M110	CAP817794	3 1/2"	CAP819604	22 (43.2)	72.0	92.0	62	-	132

4F

ADE 4F

**International Standards -
Flameproof and Increased Safety**

ATEX
IECEX
cULus Listed for Class I, Zone 2
cULus Marine Listed for Class I,
Zone 1

CEPEL
GOST-R
NEPSI
NEMA 4X and IP68

4F

Gland Type:

Armoured

Cable Type:

Steel wire armoured, steel wire braided, steel tape armoured, braided marine shipboard and lead sheathed (with addition of earthing washer)

Certifications and Compliances:

- ATEX LCIE 97 ATEX 6008X – Exd IIC/Exe II/Ex td/Ex II 2 GD
- IECEX LCI 05.0004X
- cULus listed for Class I, Zone 2 AEx e II/Ex e II E310130
- cULus Marine listed for Class I, Zone 1 AEx e II/Ex e II E314047
- NEMA 4X and IP68
- CEPEL cepel-EX-559/05X
- GOST-R POCC FR.B02011
- NEPSI N° GYJ071336U & GYJ071337U

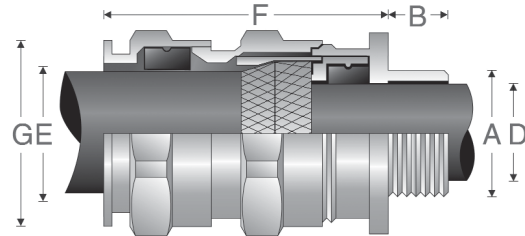

Features:

- Standard material is nickel-plated brass for superior corrosion resistance
- Armour clamping and bonding with no reversible components for easy installation, minimizing error
- Provides flameproof seal on inner jacket and weatherproof seal on outer sheath of cable
- Optional earthing washer for use with lead sheathed cable (see page 97)
- Standard neoprene seal suitable for use in operating temperatures ATEX (-60°C to 100°C), IECEX and cULus (-40°C to 100°C)
- Available with optional silicone seal for extreme temperatures
- Available with metric or NPT threads
- See pages 96–103 for related accessories

ORDERING EXAMPLE:	OPTIONS (replace last digit with option number):
CAP84640 4 KX	9 Stainless steel (316L) 8 Bronze 7 Aluminum 5 Silicone sealing ring with temperature range of -70°C to 220°C K1 Includes locknut and fiber washer K2 Includes locknut, fiber washer, earth tag, and shroud
Gland Type	Options

SELECTION TABLE

Gland Size	Entry Thread Size 'A'				Thread Length 'B' Metric (NPT)	Cable Acceptance				Armour (max)	Gland Length 'F' (less entry)	Hexagon Dimensions	
	Metric Size	Metric Catalog #	NPT Size	NPT Catalog #		Inner Sheath 'D'		Outer Sheath 'E'				Across Flats	Across Corners 'G'
						Min	Max	Min	Max				
5	M12	CAP846404	1/4"	CAP848404	15 (12.0)	4.0	8.0	6.0	12.0	0.9	36	-	20.9
5	M16	CAP846594	3/8"	CAP848594	15 (12.0)	4.0	8.5	6.0	12.0	0.9	36	-	20.9
6	M16	CAP846504	3/8"	CAP848504	15 (12.0)	6.0	12.0	8.5	16.0	1.25	42	-	26.4
5	M20	CAP846674	1/2"	CAP848674	15 (20.2)	4.0	8.5	6.0	12.0	0.9	36	-	26.4
6	M20	CAP846694	1/2"	CAP848694	15 (20.2)	6.0	12.0	8.5	16.0	1.25	42	-	26.4
7	M20	CAP846604	1/2"	CAP848604	15 (20.2)	8.5	16.0	12.0	21.0	1.25	46	-	33.0
6	M25	CAP846774	3/4"	CAP848774	15 (20.2)	6.0	12.0	8.5	16.0	1.25	42	-	33.0
7	M25	CAP846794	3/4"	CAP848794	15 (20.2)	8.5	16.0	12.0	21.0	1.25	46	-	33.0
8	M25	CAP846704	3/4"	CAP848704	15 (20.2)	12.0	20.5	16.0	27.5	1.6	56	-	45.1
8	M32	CAP846894	1"	CAP848894	15 (25.3)	12.0	21.0	16.0	27.5	1.6	56	-	45.1
9	M32	CAP846804	1"	CAP848804	15 (25.3)	16.0	27.5	21.0	34.0	1.6	63	-	52.8
9	M40	CAP846994	1 1/4"	CAP848994	15 (26.0)	16.0	27.5	21.0	34.0	1.6	63	-	52.8
10	M40	CAP846904	1 1/4"	CAP848904	15 (26.0)	21.0	34.0	27.0	41.0	2.0	68	-	60.5
10	M50	CAP847094	1 1/2"	CAP849094	15 (26.5)	21.0	34.0	27.0	41.0	2.0	68	-	60.5
11	M50	CAP847004	1 1/2"	CAP849004	15 (26.5)	27.0	41.0	33.0	48.0	2.5	74	-	70.4
12	M63	CAP847294	2"	CAP849294	17 (27.2)	27.0	41.0	33.0	48.0	2.5	77	-	79.2
13	M63	CAP847204	2"	CAP849204	17 (27.2)	33.0	48.0	47.0	56.0	2.5	85	-	93.5
13	M75	CAP847394	2 1/2"	CAP849494	18 (40.5)	40.0	56.0	47.0	65.0	2.5	85	-	93.5
14	M75	CAP847304	2 1/2"	CAP849404	18 (40.5)	47.0	65.0	54.0	74.0	2.5	92	-	104.5
15	M90	CAP847794	3"	CAP849594	22 (42.0)	54.0	74.0	63.0	83.0	3.15	104	-	121.0
16	M90	CAP847504	3"	CAP849504	22 (42.0)	63.0	82.0	72.0	93.0	3.15	108	-	132.0
16	M90	CAP847574	3 1/2"	CAP849604	N/A (43.2)	63.0	82.0	72.0*	93.0*	3.15	108	-	132.0
17	M110	CAP847794	4"	CAP849704	22 (44.5)	72.0	92.0	85.0	107.0	3.15	115	-	148.5

All dimensions in millimeters unless otherwise noted * CAP849604 "outer sheath" min: 85 max: 107.

ADE 6F

International Standards - Flameproof and Increased Safety

ATEX
IECEX
cULus Listed for Class I, Zone 2
cULus Marine Listed for Class I,
Zone 2

CEPEL
GOST-R
NEPSI
NEMA 4X and IP68

4F

Gland Type:

Armoured

Cable Type:

Steel wire armoured, steel wire braided, steel tape armoured and braided marine shipboard

Certifications and Compliances:

- ATEX LCIE 97 6008X - Exd IIC / Exe II / Ex tD / Ex II 2GD
- IECEX LCI 05.0004X
- cULus Listed for Class I, Zone 2 AEx e II / Ex e II E310130
- cULus Marine Listed for Class I, Zone 2 AEx e II / Ex e II E314047
- NEMA 4X and IP68
- CEPEL
- GOST-R
- NEPSI

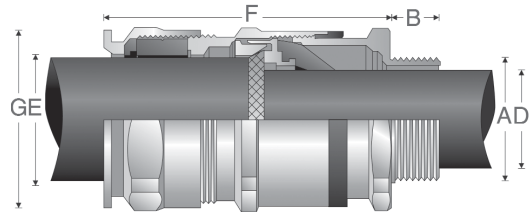

Features:

- Standard material is nickel-plated brass for superior corrosion resistance
- Armour clamping and bonding with no reversible components for easy installation, minimizing error
- Provides fully inspectable inner seal after installation
- Flameproof diaphragm seal on inner jacket does not damage cables exhibiting "cold-flow"; weatherproof seal on outer sheath of cable
- Deluge boot provides enhanced protection from water ingress
- Standard neoprene seal suitable for use in operating temperatures ATEX (-60°C to 100°C), IECEX and cULus (-40°C to 100°C)
- Available with metric or NPT threads
- See pages 96-103 for related accessories

ORDERING EXAMPLE:	OPTIONS (replace last digit with option number):
CAP96559 4	9 Stainless steel (316L) 8 Bronze
Gland Type	Options

SELECTION TABLE

Gland Size	Entry Thread Size 'A'				Thread Length 'B' Metric (NPT)	Cable Acceptance				Armour (max)	Gland Length 'F' (less entry)	Hexagon Dimensions	
	Metric Size	Metric Catalog #	NPT Size	NPT Catalog #		Inner Sheath 'D'		Outer Sheath 'E'				Across Flats	Across Corners 'G'
						Min	Max	Min	Max				
5	M16	CAP965594	3/8"	CAP967594	15 (12.0)	3.0	7.5	6.0	12.0	0.9	46.0	-	20.9
5	M20	CAP965674	1/2"	CAP967674	15 (20.2)	3.0	7.5	6.0	12.0	0.9	46.0	-	26.4
6	M20	CAP965694	1/2"	CAP967694	15 (20.2)	6.5	11.0	8.5	16.0	1.25	53.0	-	26.4
7	M20	CAP965604	1/2"	CAP967604	15 (20.2)	9.0	14.5	12.0	21.0	1.25	59.0	-	33.0
7	M25	CAP965794	3/4"	CAP967794	15 (20.2)	9.0	14.5	12.0	21.0	1.25	59.0	-	33.0
8	M25	CAP965704	3/4"	CAP967704	15 (20.2)	12.0	19.5	16.0	27.5	1.6	74.5	-	45.1
8	M32	CAP965894	1"	CAP967894	15 (25.3)	12.0	19.5	16.0	27.5	1.6	74.5	-	45.1
9	M32	CAP965804	1"	CAP967804	15 (25.3)	17.5	26.0	21.0	34.0	1.6	83.5	-	52.8
9	M40	CAP965994	1 1/4"	CAP967994	15 (26.0)	17.5	26.0	21.0	34.0	1.6	83.5	-	52.8
10	M40	CAP965904	1 1/4"	CAP967904	15 (26.0)	23.0	33.0	27.0	41.0	2.0	92.0	-	60.5
10	M50	CAP966094	1 1/2"	CAP968094	16 (26.5)	23.0	33.0	27.0	41.0	2.0	92.0	-	60.5
11	M50	CAP966004	2"	CAP968294	16 (27.2)	28.5	41.0	33.0	48.0	2.5	104.0	-	70.4

Larger sizes available in ADE 4F design, see page 72.
All dimensions in millimeters unless otherwise noted.

4F ADE 6FC

International Standards - Flameproof and Increased Safety

ATEX
IECEX
cULus Listed for Class I, Zone 2
cULus Marine Listed for Class I, Div. 1

CEPEL
GOST-R
NEMA 4X and IP68

4F

Gland Type:

Armoured barrier

Cable Type:

Steel wire armoured, steel wire braided, steel tape armoured, braided marine shipboard and lead sheathed (with addition of earthing washer)

Certifications and Compliances:

- ATEX LCIE 97 ATEX 6008X - Exd IIC/Exe II/Ex tD/Ex II 2 GD
- IECEX LCI 05.0004X
- cULus Listed for Class I, Zone 2 AEx de II/Ex de II
- cULus Marine Listed for Class I, Division 1, Groups A, B, C, D
- NEMA 4X and IP68
- CEPEL-EX-558/05X
- GOST-R POCC FR Bo2011
- NEPSI N° GYJ071336U & GYJ071337U
- ABS approbation:
n° 10-HS 577243-PDA / P1836754-X
- DNV N° E-10892
- Lloyds

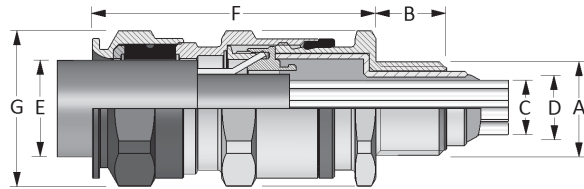

Features

- Standard material is nickel-plated brass for superior corrosion resistance
- Armour clamping with no reversible components for easy installation, minimizing error
- Provides explosionproof compound seal (denoted by red back nut) on conductors and weatherproof seal on outer sheath of cable
- Deluge boot provides enhanced protection from water ingress
- Standard neoprene seal suitable for use in operating temperatures -60°C (-25°C UL) to 80°C
- Available with metric or NPT threads
- See pages 96–103 for related accessories

ORDERING EXAMPLE:	OPTIONS (replace last digit with option number):
CAP96959 4 KX	9 Stainless steel (316L) 8 Bronze 7 Aluminum K1 Includes locknut and fiber washer K2 Includes locknut, fiber washer, earth tag, and shroud
Gland Type	Options

SELECTION TABLE

Gland Size	Entry Thread Size 'A'				Thread Length 'B' Metric (NPT)	Cable Acceptance						Armour (max)	Gland Length 'F' (less entry)	Hexagon Dimensions	
	Metric Size	Metric Catalog #	NPT Size	NPT Catalog #		Inner Sheath and Cores			Outer Sheath 'E'		Across Flats			Across Corners 'G'	
						Max Over Cores 'C'	Max Inner Sheath 'D'	Max No. of Cores	Min	Max					
5	M16	CAP969594	3/8"	CAP974594	15 (12.0)	6.5	7.5	6.0	6.0	12.0	0.9	46.0	-	20.9	
5	M20	CAP969674	1/2"	CAP971674	15 (20.2)	6.5	7.5	6.0	6.0	12.0	0.9	46.0	-	26.4	
6	M20	CAP969694	1/2"	CAP971694	15 (20.2)	9.5	11.0	6.0	8.5	16.0	1.25	53.0	-	26.4	
7	M20	CAP969604	1/2"	CAP971604	15 (20.2)	12.0	14.5	10.0	12.0	21.0	1.25	59.0	-	33.0	
7	M25	CAP969794	3/4"	CAP971794	15 (20.5)	12.0	14.5	10.0	12.0	21.0	1.25	59.0	-	33.0	
8	M25	CAP969704	3/4"	CAP971704	15 (20.5)	17.0	19.5	21.0	16.0	27.5	1.6	74.5	-	45.1	
8	M32	CAP969894	1"	CAP971894	15 (25.3)	17.0	19.5	21.0	16.0	27.5	1.6	74.5	-	45.1	
9	M32	CAP969804	1"	CAP971804	15 (25.3)	23.0	28.0	42.0	21.0	34.0	1.6	83.5	-	52.8	
9	M40	CAP969994	1 1/4"	CAP971994	15 (26.0)	23.0	28.0	42.0	21.0	34.0	1.6	83.5	-	52.8	
10	M40	CAP969904	1 1/4"	CAP971904	15 (26.0)	29.0	33.0	60.0	27.0	41.0	2.0	92.0	-	60.5	
10	M50	CAP970094	1 1/2"	CAP972094	16 (26.5)	29.0	33.0	60.0	27.0	41.0	2.0	92.0	-	60.5	
11	M50	CAP970004	1 1/2"	CAP972004	16 (27.2)	36.5	41.0	80.0	33.0	48.0	2.5	104.0	-	70.4	
12	M63	CAP970294	2"	CAP972274	17 (29.2)	43.0	48.0	100.0	40.0	56.0	2.5	108.0	-	79.2	
13	M63	CAP970204	2"	CAP972204	17 (29.2)	50.0	56.0	100.0	46.0	65.0	2.5	118.0	-	93.5	
13	M75	CAP970394	2 1/2"	CAP972494	18 (42.5)	50.0	56.0	100.0	46.0	65.0	2.5	118.0	-	93.5	
14	M75	CAP970304	2 1/2"	CAP972404	18 (42.5)	59.0	65.0	120.0	54.0	74.0	2.5	124.0	-	104.5	
14	-	-	3"	CAP972574	(44)	59.0	65.0	120.0	54.0	74.0	2.5	124.0	-	104.5	
15	M90	CAP970594	3"	CAP972594	22 (44.0)	66.0	73.0	140.0	63.0	83.0	3.15	133.0	-	121.0	
15	-	-	3 1/2"	CAP972694	(45.2)	66.0	73.0	140.0	63.0	83.0	3.15	133.0	-	121.0	
16	M90	CAP970504	3"	CAP972504	22 (44.0)	75.0	82.0	140.0	72.0	93.0	3.15	137.0	-	132.0	
16	-	-	3 1/2"	CAP972604	(45.2)	75.0	82.0**	140.0	72.0	93.0	3.15	137.0	-	132.0	
17	M110	CAP970794	4"	CAP972704	22 (46.5)	85.0	92.0**	200.0	85.0	107.0	3.15	142.0	-	148.5	

All dimensions in millimeters unless otherwise noted.

*Aluminum not currently available with UL marine certification.

**Contact Customer Service or your field sales representative for amended UL marine range.

**International Standards -
Flameproof and Increased Safety**

Gland Type:

Non-armoured barrier

Cable Type:

Non-armoured, armoured and tray cable (does not terminate the armour)

Certifications and Compliances:

- LCIE 97 ATEX 6008X II GD - Exd IIC/Exe II/Ex tD
- IECEX LCI 05.0004X Ex c e IIC/Ex c e II/Ex tD
- cULus Listed for Class I, Zone 2 AEx de II/Ex de II
- UL Marine Listed for Class I, Division 2, Groups A, B, C, D
- NEMA 4X and IP68
- CEPEL EX-558/05X
- GOST-R POCC FR.B03126
- NEPSI N° GYJ071336U & GYJ071337U
- DNV N° E-10892
- ABS approbation:
n° 10-HS 577243-PDA / P1836754-X
- Lloyds

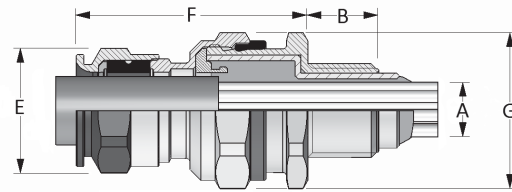

Features:

- Standard material is nickel-plated brass for superior corrosion resistance
- Provides a flameproof and weatherproof seal on outer sheath of cable
- Provides explosionproof compound seal (denoted by red back nut) on conductors
- Deluge boot provides enhanced protection from water ingress
- Standard neoprene seal suitable for use in operating temperatures -60°C (-25°C UL) to 80°C
- Available with metric or NPT threads
- See pages 96–103 for related accessories

ORDERING EXAMPLE:	OPTIONS (replace last digit with option number):				
<table border="1" style="margin: auto;"> <tr> <td style="padding: 5px;">CAP01959</td> <td style="padding: 5px;">4 KX</td> </tr> <tr> <td style="font-size: 8px;">Gland Type</td> <td style="font-size: 8px;">Options</td> </tr> </table>	CAP01959	4 KX	Gland Type	Options	9 Stainless steel (316L) 8 Bronze 7 Aluminum K1 Includes locknut and fiber washer K2 Includes locknut, fiber washer, earth tag, and shroud
CAP01959	4 KX				
Gland Type	Options				

SELECTION TABLE

Gland Size	Entry Thread Size 'A'				Thread Length 'B' Metric (NPT)	Cable Acceptance Outer Sheath 'E'		Max No. Cores	Gland Length 'F' (less entry)	Hexagon Dimensions	
	Metric Size	Metric Catalog #	NPT Size	NPT Catalog #		Min	Max			Across Flats	Across Corners 'G'
4	M16	CAP019594	3/8"	CAP011594	15 (12.0)	4.0	7.5	6.0	46.0	-	20.9
4	M20	CAP019674	1/2"	CAP011674	15 (22.2)	4.0	7.5	6.0	46.0	-	26.4
5	M20	CAP019694	1/2"	CAP011694	15 (22.2)	6.5	11.0	6.0	53.0	-	26.4
6	M20	CAP019604	1/2"	CAP011604	15 (22.2)	9.0	14.5	10.0	59.0	-	33.0
6	M25	CAP019794	3/4"	CAP011794	15 (22.5)	9.0	14.5	10.0	59.0	-	33.0
7	M25	CAP019704	3/4"	CAP011704	15 (22.5)	12.0	19.5	21.0	74.5	-	45.1
7	M32	CAP019894	1"	CAP011894	15 (27.3)	12.0	19.5	21.0	74.5	-	45.1
8	M32	CAP019804	1"	CAP011804	15 (27.3)	17.5	26.0	42.0	83.5	-	52.8
8	M40	CAP019994	1 1/4"	CAP011994	15 (28.0)	17.5	26.0	42.0	83.5	-	52.8
9	M40	CAP019904	1 1/4"	CAP011904	15 (28.0)	23.0	33.0	60.0	92.0	-	60.5
9	M50	CAP019094	1 1/2"	CAP011094	16 (28.5)	23.0	33.0	60.0	92.0	-	60.5
10	M50	CAP019004	2"	CAP011004	16 (29.2)	28.5	41.0	80.0	104.0	-	70.4
10	M63	CAP019204	-	-	16	28.5	41.0	80.0	-	-	73.7
11	M63	CAP019294	2"	CAP011294	17 (29.2)	43.0	48.0	100.0	98.0	-	70.4
12	M63	CAP019274	2"	CAP011204	17 (29.2)	50.0	56.0	100.0	103.0	-	79.2
12	-	-	2 1/2"	CAP011494	42.5	50.0	56.0	100.0	103.0	-	79.2
13	M75	CAP019304	2 1/2"	CAP011404	18 (42.5)	59.0	65.0	120.0	111.0	-	93.5
13	-	-	3"	CAP012504	44	59.0	65.0	120.0	111.0	-	93.5
14	M90	CAP010594	3"	CAP012574	22 (44.0)	66.0	73.0	140.0	120.0	-	104.5
14	-	-	3 1/2"	CAP012604	45.2	66.0	73.0	140.0	120.0	-	104.5
15	M90	CAP010504	3"	CAP012594	22 (44.0)	75.0	82.0	140.0	125.0	-	121.0
15	-	-	3 1/2"	CAP012694	45.2	75.0	82.0**	140.0	125.0	-	121.0
16	M110	CAP010794	4"	CAP012704	22 (46.5)	85.0	92.0**	200.0	128.0	-	132.0

All dimensions in millimeters unless otherwise noted.
 *Aluminum not currently available with UL marine certification.
 **Contact Customer Service or your field sales representative for amended UL marine range.



4F

Ex-e

**International Standards -
Flameproof and Increased Safety**

Sizes M12-M16: PTB 99 ATEX IP66
3101 X
Sizes M20-M63: PTB 99 ATEX
3128 X
IECEX

4F

Gland Type:

Non-armoured

Cable Type:

Non-armoured

Certifications and Compliances:

- Sizes M12-M16: PTB 99 ATEX 3101 X
Sizes M20-M63: PTB 99 ATEX 3128 X
Ex II 2 G Ex e II/Ex II 2 D Ex tD A21
- IECEX PTB 05.0004X
- IP66

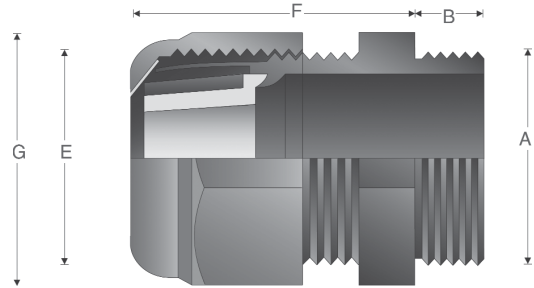

Features:

- Standard material is high-impact resistant polyamide
- Forms weatherproof seal on outer sheath of cable
- Standard silicone seal suitable for use in operating temperatures -55° to 70°C (M12 and M16 for use in operating temperatures -20° to 70°C)
- Available with optional silicone seal for extreme temperatures
- Available with metric threads
- See page 101 for related accessories

SELECTION TABLE - SHORT THREAD

Gland Size	Entry Thread Size 'A'		Thread Length 'B' Metric	Cable Acceptance Outer Sheath 'E'		Gland Length 'F' (less entry)	Hexagon Dimensions	
	Metric Size	Metric Catalog #		Min	Max		Across Flats	Across Corners 'G'
16	M16	GHG 960 1955 R 0002	8.0	5.5	10.0	23.0	20.0	22.0
20	M20	GHG 960 1955 R 0003	8.0	5.5	13.0	25.0	24.0	26.4
25	M25	GHG 960 1955 R 0004	8.0	8.0	17.0	29.5	29.0	31.9
32	M32	GHG 960 1955 R 0005	10.0	12.0	21.0	35.5	36.0	39.6

SELECTION TABLE - LONG THREAD

Gland Size	Entry Thread Size 'A'		Thread Length 'B' Metric	Cable Acceptance Outer Sheath 'E'		Gland Length 'F' (less entry)	Hexagon Dimensions	
	Metric Size	Metric Catalog #		Min	Max		Across Flats	Across Corners 'G'
16	M16	GHG 960 1955 R 0022	8.0	5.5	10.0	23.0	20.0	22.0
20	M20	GHG 960 1955 R 0023	8.0	5.5	13.0	25.0	24.0	26.4
25	M25	GHG 960 1955 R 0024	8.0	8.0	27.0	29.5	29.0	31.9
32	M32	GHG 960 1955 R 0025	10.0	12.0	21.0	35.5	36.0	39.6
40	M40	GHG 960 1955 R 0026	15.0	17.0	28.0	39.5	46.0	50.6
50	M50	GHG 960 1955 R 0027	16.0	22.0	35.0	44.0	55.0	60.5
63	M63	GHG 960 1955 R 0028	16.0	27.0	48.0	47.0	68.0	74.8

All dimensions in millimeters unless otherwise noted.

Ex-i

International Standards - Flameproof and Increased Safety

Sizes M12-M16: PTB 99 ATEX IP66
3101 X
Sizes M20-M63: PTB 99 ATEX
3128 X
IECEX

4F

Gland Type:

Non-armoured

Cable Type:

Non-armoured

Certifications and Compliances:

- Sizes M12-M16: PTB 99 ATEX 3101 X
Sizes M20-M63: PTB 99 ATEX 3128 X
Ex II 2 G Ex e II/Ex II 2 D Ex tD A21
- IECEX PTB 05.0004X
- IP66

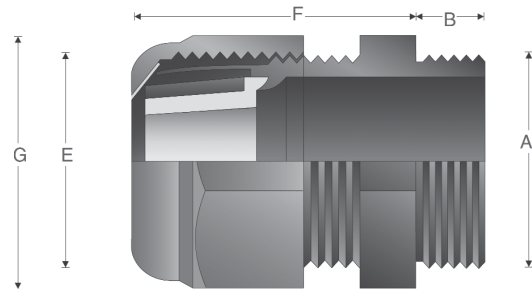

Features:

- Standard material is high-impact resistant polyamide (gland nut is blue for intrinsically safe circuits)
- Forms weatherproof seal on outer sheath of cable
- Standard silicone seal suitable for use in operating temperatures -55° to 70°C (M12 and M16 for use in operating temperatures -20° to 70°C)
- Available with metric threads
- See page 101 for related accessories

SELECTION TABLE – SHORT THREAD

Gland Size	Entry Thread Size 'A'		Thread Length 'B' Metric	Cable Acceptance		Gland Length 'F' (less entry)	Hexagon Dimensions	
	Metric Size	Metric Catalog #		Outer Sheath 'E'			Across Flats	Across Corners 'G'
				Min	Max			
12	M12	GHG 960 1955 R 0101	8.0	4.0	7.0	19.3	15.0	16.5
16	M16	GHG 960 1955 R 0102	8.0	5.5	10.0	23.0	20.0	22.0
20	M20	GHG 960 1955 R 0103	8.0	5.5	13.0	25.0	24.0	26.4
25	M25	GHG 960 1955 R 0104	8.0	8.0	17.0	29.5	29.0	31.9
32	M32	GHG 960 1955 R 0105	10.0	12.0	21.0	35.5	36.0	39.6

SELECTION TABLE – LONG THREAD

Gland Size	Entry Thread Size 'A'		Thread Length 'B' Metric	Cable Acceptance		Gland Length 'F' (less entry)	Hexagon Dimensions	
	Metric Size	Metric Catalog #		Outer Sheath 'E'			Across Flats	Across Corners 'G'
				Min	Max			
12	M12	GHG 960 1955 R 0121	12.0	4.0	7.0	19.3	15.0	16.5
16	M16	GHG 960 1955 R 0122	12.0	5.5	10.0	23.0	20.0	22.0
20	M20	GHG 960 1955 R 0123	13.0	5.5	13.0	25.0	24.0	26.4
25	M25	GHG 960 1955 R 0124	13.0	8.0	17.0	29.5	29.0	31.9
32	M32	GHG 960 1955 R 0125	15.0	12.0	21.0	35.5	36.0	39.6
40	M40	GHG 960 1955 R 0126	15.0	17.0	28.0	39.5	46.0	50.6
50	M50	GHG 960 1955 R 0127	16.0	22.0	35.0	44.0	55.0	60.5
63	M63	GHG 960 1955 R 0128	16.0	27.0	48.0	47.0	68.0	74.8

All dimensions in millimeters unless otherwise noted.

**International Standards -
Flameproof and Increased Safety**

4F

Gland Type:

Non-armoured

Cable Type:

Non-armoured

Certifications and Compliances:

- ATEX PTB 00ATEX3121X Ex II 2 G Ex e II/Ex II 2 D Ex tD A21
- IP66

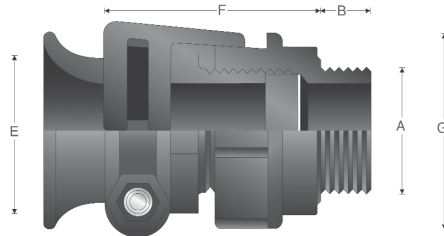

Features:

- Standard material is high-impact resistant polyamide
- Forms weatherproof seal on outer sheath of cable
- Flared rear seal provides protection for cable
- Standard neoprene seal suitable for use in operating temperatures -40° to 85°C
- Available with metric threads
- See page 101 for related accessories

SELECTION TABLE

Gland Size	Entry Thread Size 'A'		Thread Length 'B' Metric	Cable Acceptance		Gland Length 'F' (less entry)	Hexagon Dimensions	
	Metric Size	Metric Catalog #		Outer Sheath 'E'			Across Flats	Across Corners 'G'
				Min	Max			
20	M20	GHG 960 1949 R0111	15.0	8.0	13.0	49.0	26.0	28.6
25	M25	GHG 960 1949 R0112	15.0	11.0	16.0	50.0	32.0	35.2
32	M32	GHG 960 1949 R0113	15.0	15.0	20.0	65.0	41.0	45.1
40	M40	GHG 960 1949 R0114	15.0	19.0	27.0	71.0	50.0	55.0
50	M50	GHG 960 1949 R0115	16.0	26.0	34.0	79.0	60.0	66.0
60	M60	GHG 960 1949 R0116	16.0	35.0	46.0	89.0	75.0	82.5

All dimensions in millimeters unless otherwise noted.

Enlargement and Multiple

International Standards - Flameproof and Increased Safety

Sizes M16: PTB 99 ATEX 3101 X
 Sizes M20-M63: PTB 99 ATEX
 3128 X
 IECEx

IP66

4F

4F

Gland Type:

Non-armoured

Cable Type:

Non-armoured

Certifications and Compliances:

- Sizes M16: PTB 99 ATEX 3101 X
 Sizes M20-M63: PTB 99 ATEX 3128 X
 Ex II 2 G Ex e II/Ex II 2 D Ex tD A21
- IECEx PTB 05.0004X
- IP66

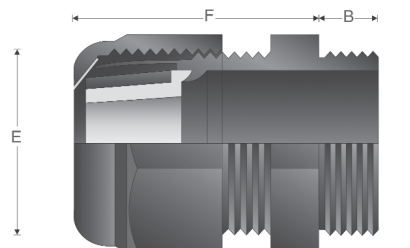

Features:

- Standard material is high-impact resistant polyamide
- Forms weatherproof seal on outer sheath of cable
- Provides reduced entry threads for larger gland size
- Standard silicone seal suitable for use in operating temperatures -55° to 70°C (M16 for use in operating temperatures -20° to 70°C)
- Available with metric threads
- See page 101 for related accessories

SELECTION TABLE – ENLARGEMENT

Gland Size	Entry Thread Size 'A'		Thread Length 'B' Metric	Cable Acceptance Outer Sheath 'E'		Gland Length 'F' (less entry)	Hexagon Dimensions	
	Metric Size	Metric Catalog #		Min	Max		Across Flats	Across Corners 'G'
20/25	M20	GHG 960 1956 R0003	13.0	8.0	17.0	29.5	29.0	31.9
25/32	M25	GHG 960 1956 R0004	13.0	12.0	21.0	35.5	36.0	39.6
32/40	M32	GHG 960 1956 R0005	15.0	16.0	28.0	39.5	46.0	50.6
40/50	M40	GHG 960 1956 R0006	15.0	21.0	35.0	44.0	55.0	60.5
50/63	M50	GHG 960 1956 R0007	16.0	27.0	48.0	47.0	68.0	74.8

SELECTION TABLE – MULTIPLE

Gland Size	Entry Thread Size 'A'		Thread Length 'B' Metric	Cable Acceptance Outer Sheath 'E'		Maximum Number of Conductors	Gland Length 'F' (less entry)	Hexagon Dimensions	
	Metric Size	Metric Catalog #		Min	Max			Across Flats	Across Corners 'G'
32	M32	GHG 960 1955 R0055	10.0	4.5	7.0	4	39.5	46.0	50.6

All dimensions in millimeters unless otherwise noted.

International Standards - Industrial

4F

Gland Type:

Armoured

Cable Type:

Steel wire armoured, steel wire braided, steel tape armoured, braided marine shipboard lead sheathed (with addition of earthing washer) and tray cable

Certifications and Compliances:

- NEMA 4X and IP68

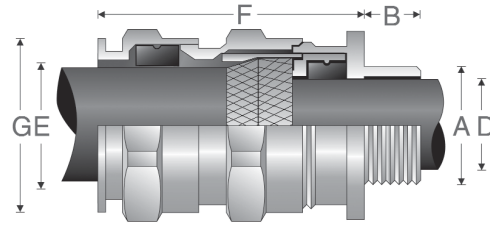

Features:

- Standard material is nickel-plated brass for superior corrosion resistance
- Armour clamping and bonding with no reversible components for easy installation, minimizing error
- Provides seal on inner jacket and weatherproof seal on outer sheath of the cable
- An optional earthing washer for use with lead sheathed cable (see page 97)
- Standard neoprene seal suitable for use in operating temperatures of -60°C to 100°C
- Available with optional silicone seal for extreme temperatures
- Available with metric or NPT threads
- See pages 96–103 for related accessories

ORDERING EXAMPLE:	OPTIONS (replace last digit with option number):
CAP94640 4	9 Stainless steel (316L)
	8 Bronze
	7 Aluminum
	5 Silicone sealing ring with temperature range of -70° C to 220° C
Gland Type	Options
Available in stainless steel – contact customer service	

SELECTION TABLE

Gland Size	Entry Thread Size 'A'				Thread Length 'B' Metric (NPT)	Cable Acceptance				Armour (max)	Gland Length 'F' (less entry)	Hexagon Dimensions	
	Metric Size	Metric Catalog #	NPT Size	NPT Catalog #		Inner Sheath 'D'		Outer Sheath 'E'				Across Flats	Across Corners 'G'
						Min	Max	Min	Max				
5	M12	CAP946404	1/4"	CAP948404	15 (12.0)	4.0	8.0	6.0	12.0	0.9	36.0	–	20.9
5	M16	CAP946594	3/8"	CAP948594	15 (12.0)	4.0	8.5	6.0	12.0	0.9	36.0	–	20.9
6	M16	CAP946504	3/8"	CAP948504	15 (12.0)	6.0	12.0	8.5	16.0	1.25	42.0	–	26.4
5	M20	CAP946674	1/2"	CAP948674	15 (20.2)	4.0	8.5	6.0	12.0	0.9	36.0	–	26.4
6	M20	CAP946694	1/2"	CAP948694	15 (20.2)	6.0	12.0	8.5	16.0	1.25	42.0	–	26.4
7	M20	CAP946604	1/2"	CAP948604	15 (20.2)	8.5	16.0	12.0	21.0	1.25	46.0	–	33.0
6	M25	CAP946774	3/4"	CAP948774	15 (20.2)	6.0	12.0	8.5	16.0	1.25	42.0	–	33.0
7	M25	CAP946794	3/4"	CAP948795	15 (20.2)	8.5	16.0	12.0	21.0	1.25	46.0	–	33.0
8	M25	CAP946704	3/4"	CAP948704	15 (20.2)	12.0	20.5	16.0	27.5	1.6	56.0	–	45.1
8	M32	CAP946894	1"	CAP948894	15 (25.3)	12.0	21.0	16.0	27.5	1.6	56.0	–	45.1
9	M32	CAP946804	1"	CAP948804	15 (25.3)	16.0	27.5	21.0	34.0	1.6	63.0	–	52.8
9	M40	CAP946994	1 1/4"	CAP948994	15 (26.0)	16.0	27.5	21.0	34.0	1.6	63.0	–	52.8
10	M40	CAP946904	1 1/4"	CAP948904	15 (26.0)	21.0	34.0	27.0	41.0	2.0	68.0	–	60.5
10	M50	CAP947094	1 1/2"	CAP949904	16 (26.5)	21.0	34.0	27.0	41.0	2.0	68.0	–	60.5
11	M50	CAP947004	1 1/2"	CAP949004	16 (26.5)	27.0	41.0	33.0	48.0	2.5	74.0	–	70.4
12	M63	CAP947294	2"	CAP949294	17 (27.2)	27.0	41.0	33.0	48.0	2.5	77.0	–	79.2
13	M63	CAP947204	2"	CAP949204	17 (27.2)	33.0	48.0	40.0	56.0	2.5	85.0	–	93.5
13	M75	CAP947394	2 1/2"	CAP949949	18 (40.5)	40.0	56.0	47.0	65.0	2.5	85.0	–	93.5
14	M75	CAP947304	2 1/2"	CAP949404	18 (40.5)	47.0	65.0	54.0	74.0	2.5	92.0	–	104.5
15	M90	CAP947594	3"	CAP949564	22 (42.0)	54.0	74.0	63.0	83.0	3.15	104.0	–	121.0
16	M90	CAP947504	3"	CAP949504	22 (42.0)	63.0	82.0	72.0	93.0	3.15	108.0	–	132.0
16	–	–	3 1/2"	CAP949604	– (43.2)	63.0	82.0	72.0	93.0	3.15	108.0	–	132.0
17	M110	CAP947794	4"	CAP949704	22 (44.5)	72.0	92.0	85.0	107.0	3.15	115.0	–	148.5

All dimensions in millimeters unless otherwise noted.

Terminator™ II TMCX

North American Standards -
Explosionproof

UL/cULus Listed
Cl. I, Div. 1, Groups A, B, C, D
Cl. II, Groups E, F, G
Cl. III

NEMA 6P
IECEX/ATEX (Pending)

4F

Gland Type:

Armoured barrier, TECK armoured, and non-armoured barrier

Cable Type:

Metal-clad and TECK (interlocked and continuously welded corrugated armoured), unarmoured, and tray cable

Certifications and Comiances:

- Class I, Division 1, Groups A, B, C, D
- Class II, Groups E, F, G
- Class III
- NEMA 6P
- UL/cULus Listed - File No. E122485
- IECEX/ATEX (Pending)

Features:

- Designed to minimize the opportunity for incorrect assembly
- Simple selection process and field preparation aids to ensure the right gland is selected every time
- Full coverage of all popular cables and hub sizes, ensuring a perfect seal in all instances
- Use of nickel-plated brass and stainless steel to increase corrosion resistance and maintain integrity in the harshest environments
- Chico® LiquidSeal, an innovative liquid compound with fast gel and cure times, reduces waiting times
- Complete with integral dam to facilitate liquid pour
- Integral union design reduces the number of times the gland has to be assembled and disassembled during installation

- Mating components have generous lead-ins to ensure that assembly is as trouble-free as possible, even with the heaviest cables
- Use of neoprene seal allows use in temperatures from -40°C to +60°C; for specific temperature information, please contact your local sales representative
- Metric size threads allow interfacing to European machinery
- Wide range of global certifications and approvals
- See page 102 for related accessories



SELECTION TABLE

Entry Thread 'C'	NPT Catalog #	Entry Thread 'C' (Metric Option)	Metric Catalog #	Over Conductors O.D. Max. Inches 'G'	'A' Armour O.D.		'B' Cable O.D.†		Across Corners 'D'	Thread Length NPT 'E' (Metric mm.)	Length 'F'
					Min.	Max.	Min.	Max.			
1/2"	TMCX050 1	M20	TMCXM20 1	0.480	0.40 (10.16)	0.86 (21.84)	0.49 (12.45)	0.90 (22.86)	1.75 (44.45)	1.00 (25.40)	3.05 (77.47)
1/2"	TMCX050 2	M20	TMCXM20 2	0.480	0.56 (14.22)	1.14 (28.96)	0.65 (16.51)	1.18 (29.97)	2.25 (57.15)	1.00 (25.40)	3.18 (80.77)
3/4"	TMCX075 1	M25	TMCXM25 1	0.713	0.40 (10.16)	0.86 (21.84)	0.49 (12.45)	0.90 (22.86)	1.75 (44.45)	1.00 (25.40)	3.05 (77.47)
3/4"	TMCX075 2	M25	TMCXM25 2	0.713	0.56 (14.22)	1.14 (28.96)	0.65 (16.51)	1.18 (29.97)	2.25 (57.15)	1.00 (25.40)	3.18 (80.77)
1"	TMCX100 1	M32	TMCXM32 1	0.939	0.56 (14.22)	1.14 (28.96)	0.65 (16.51)	1.18 (29.97)	2.25 (57.15)	1.08 (27.40)	3.18 (80.77)
1"	TMCX100 2	M32	TMCXM32 2	0.939	0.78 (19.81)	1.35 (34.29)	0.87 (22.10)	1.39 (35.31)	2.56 (65.02)	1.08 (27.40)	3.30 (83.82)
1 1/4"	TMCX125 1	M40	TMCXM40 1	1.172	0.78 (19.81)	1.35 (34.29)	0.87 (22.10)	1.39 (35.31)	2.56 (65.02)	1.08 (27.40)	3.30 (83.82)

All dimensions in inches; metric millimeters shown in parenthesis. Sizes 1 1/2" and above will be available soon.

†When making your cable gland selection based on Cable O.D., be sure to also observe the Over Conductors O.D. dimension.

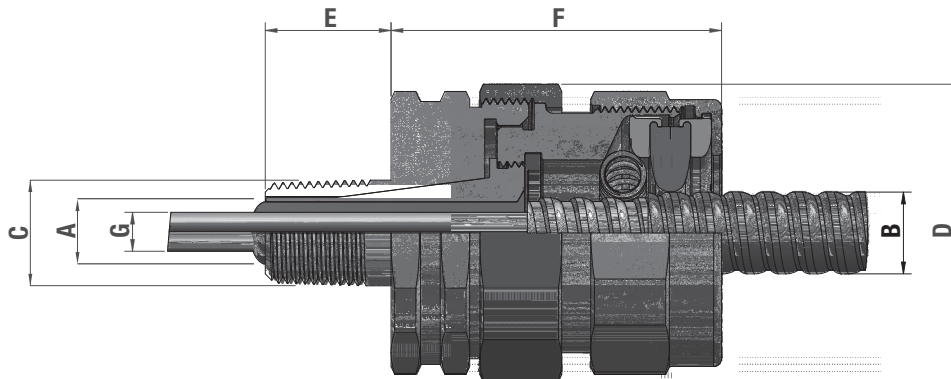

4F Terminator™ II TMCX

North American Standards -
Explosionproof

UL/cULus Listed
Cl. I, Div. 1, Groups A, B, C, D
Cl. II, Groups E, F, G
Cl. III

NEMA 6P
IECEX/ATEX (Pending)

4F

Catalog Numbering System:

TMCX

050

1

NP

L

Hub Size

NPT	Hub (in.)	Metric	Hub (mm.)
050	½"	M20	20
075	¾"	M25	25
100	1"	M32	32
125	1-¼"	M40	40

Cable Sealing Range

Hub Size Code	Thread		Sealing Range Code	Standard Cable Sealing Range
050	½"	NPT	1	0.49" - 0.90"
			2	0.65" - 1.18"
075	¾"	NPT	1	0.49" - 0.90"
			2	0.65" - 1.18"
100	1"	NPT	1	0.65" - 1.18"
			2	0.87" - 1.39"
125	1-¼"	NPT	1	0.87" - 1.39"
M20	M20	ISO	1	12.4 mm - 22.8 mm
			2	16.5 mm - 29.9 mm
M25	M25	ISO	1	12.4 mm - 22.8 mm
			2	16.5 mm - 29.9 mm
M32	M32	ISO	1	16.5 mm - 29.9 mm
			2	22.0 mm - 35.3 mm
M40	M40	ISO	1	22.0 mm - 35.3 mm

Material

BLANK	Aluminum
SS	316 Stainless Steel
NP	Nickel-plated Brass

Compound Type

BLANK	TSC
L	Liquid

**North American Standards -
 Explosionproof**

Gland Type:

Armoured barrier, TECK armoured and non-armoured barrier

Cable Type:

Metal-clad (interlocked or continuously welded corrugated armoured), non-armoured and tray cable

Certifications and Compliances:

- UL Listed, CSA Certified Class I, Div. 1, Groups, A, B, C, D; Class II; Class III – UL File E122485, CSA File LR13046
- NEMA 4 and IP56 rated
- Wet locations

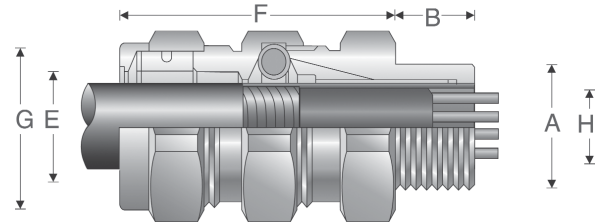

Features:

- Standard material is aluminum
- Stainless steel copper-plated spring provides grounding continuity of cable armour (MC cable only)
- Provides explosionproof compound seal on conductors and watertight seal on outer sheath of cable
- Standard neoprene seal suitable for use in operating temperatures -25° to 60°C
- Cold Shrink™ Kit is available for extra protection in aggressive environments (see page 102)
- Available with NPT threads
- See page 102 for related accessories

ORDERING EXAMPLE:		OPTIONS (add after gland type):	
TMCX165 -BR		-BR Brass construction (i.e.,TMCX285-BR)	
		-NP Nickel-plate finish (i.e.,TMCX285-BR-NP)	
Gland Type	Options		

SELECTION TABLE

Entry Thread Size 'A'		Thread Length 'B' NPT	Cable Acceptance				Gland Length 'F' (less entry)	Hexagon Dimensions	
NPT Size	NPT Catalog #		Armour Range 'H'		Outer Sheath 'E'			Across Flats	Across Corners 'G'
			Min	Max	Min	Max			
1/2"	TMCX165	0.750	0.440	0.650	0.490	0.781	2.625	1.250	1.375
3/4"	TMCX285	0.781	0.600	0.850	0.650	1.000	2.875	1.500	1.625
1"	TMCX3112	0.938	0.800	1.120	0.850	1.313	3.125	1.875	2.000
1 1/4"	TMCX4140	0.969	1.100	1.400	1.150	1.625	3.125	2.250	2.438
1 1/2"	TMCX5161	0.969	1.330	1.610	1.380	1.781	3.375	2.500	2.750
2"	TMCX6206	1.000	1.570	2.060	1.630	2.313	5.313	3.250	3.500
2 1/2"	TMCX7247	1.438	1.930	2.470	1.990	2.719	6.063	3.750	4.000
3"	TMCX8302	1.438	2.450	3.020	2.525	3.281	6.063	4.500	4.875
3 1/2"	TMCX9352	1.625	2.950	3.520	3.025	3.781	7.750	5.000	5.375
4"	TMCX10402	1.625	3.500	4.020	3.585	4.281	8.313	5.500	5.875

All dimensions in inches unless otherwise noted.

4F ADE 6FC

North American Standards - Explosionproof

ATEX
IECEX
cULus Listed for Class I, Zone 2
cULus Marine Listed for Class I, Div. 1

CEPEL
GOST-R
NEMA 4X and IP68

4F

Gland Type:

Armoured barrier

Cable Type:

Steel wire armoured, steel wire braided, steel tape armoured, braided marine shipboard and lead sheathed (with addition of earthing washer)

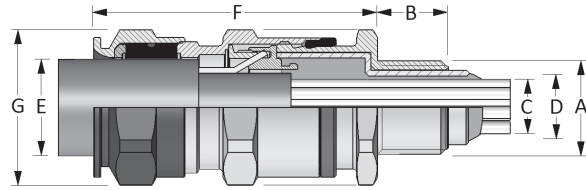

Certifications and Compliances:

- ATEX LCIE 97 ATEX 6008X - Exd IIC/Exe II/Ex tD/Ex II 2 GD
- IECEX LCI 05.0004X
- cULus Listed for Class I, Zone 2 AEx de II/Ex de II
- cULus Marine Listed for Class I, Division 1, Groups A, B, C, D
- NEMA 4X and IP68
- CEPEL-EX-558/05X
- GOST-R POCC FR Bo2011
- NEPSI N° GYJ071336U & GYJ071337U
- ABS approbation:
n° 10-HS 577243-PDA / P1836754-X
- DNV N° E-10892
- Lloyds

Features:

- Standard material is nickel-plated brass for superior corrosion resistance
- Armour clamping with no reversible components for easy installation, minimizing error
- Provides explosionproof compound seal (denoted by red back nut) on conductors and weatherproof seal on outer sheath of cable
- Deluge boot provides enhanced protection from water ingress
- Standard neoprene seal suitable for use in operating temperatures -60°C (-25°C UL) to 80°C
- Available with metric or NPT threads
- See pages 96-99 for related accessories

ORDERING EXAMPLE:

CAP96959 4 KX

Gland Type Options

OPTIONS (replace last digit with option number):

- 9 Stainless steel (316L)
- 8 Bronze
- 7 Aluminum
- K1 Includes locknut and fiber washer
- K2 Includes locknut, fiber washer, earth tag, and shroud

SELECTION TABLE

Gland Size	Entry Thread Size 'A'				Thread Length 'B' Metric (NPT)	Cable Acceptance					Armour (max)	Gland Length 'F' (less entry)	Hexagon Dimensions	
	Metric Size	Metric Catalog #	NPT Size	NPT Catalog #		Inner Sheath and Cores			Outer Sheath 'E'				Across Flats	Across Corners 'G'
						Max Over Cores 'C'	Max Inner Sheath 'D'	Max No. of Cores	Min	Max				
5	M16	CAP969594	3/8"	CAP974594	15 (12.0)	6.5	7.5	6.0	6.0	12.0	0.9	46.0	-	20.9
5	M20	CAP969674	1/2"	CAP971674	15 (20.2)	6.5	7.5	6.0	6.0	12.0	0.9	46.0	-	26.4
6	M20	CAP969694	1/2"	CAP971674	15 (20.2)	9.5	11.0	6.0	8.5	16.0	1.25	53.0	-	26.4
7	M20	CAP969604	1/2"	CAP971604	15 (20.2)	12.0	14.5	10.0	12.0	21.0	1.25	59.0	-	33.0
7	M25	CAP969794	3/4"	CAP971794	15 (20.5)	12.0	14.5	10.0	12.0	21.0	1.25	59.0	-	33.0
8	M25	CAP969704	3/4"	CAP971704	15 (20.5)	17.0	19.5	21.0	16.0	27.5	1.6	74.5	-	45.1
8	M32	CAP969894	1"	CAP971894	15 (25.3)	17.0	19.5	21.0	16.0	27.5	1.6	74.5	-	45.1
9	M32	CAP969804	1"	CAP971804	15 (25.3)	23.0	28.0	42.0	21.0	34.0	1.6	83.5	-	52.8
9	M40	CAP969994	1 1/4"	CAP971994	15 (26.0)	23.0	28.0	42.0	21.0	34.0	1.6	83.5	-	52.8
10	M40	CAP969904	1 1/4"	CAP971904	15 (26.0)	29.0	33.0	60.0	27.0	41.0	2.0	92.0	-	60.5
10	M50	CAP970094	1 1/2"	CAP972094	16 (26.5)	29.0	33.0	60.0	27.0	41.0	2.0	92.0	-	60.5
11	M50	CAP970004	1 1/2"	CAP972004	16 (27.2)	36.5	41.0	80.0	33.0	48.0	2.5	104.0	-	70.4
12	M63	CAP970294	2"	CAP972274	17 (29.2)	43.0	48.0	100.0	40.0	56.0	2.5	108.0	-	79.2
13	M63	CAP970204	2"	CAP972204	17 (29.2)	50.0	56.0	100.0	46.0	65.0	2.5	118.0	-	93.5
13	M75	CAP970394	2 1/2"	CAP972494	18 (42.5)	50.0	56.0	100.0	46.0	65.0	2.5	118.0	-	93.5
14	M75	CAP970304	2 1/2"	CAP972404	18 (42.5)	59.0	65.0	120.0	54.0	74.0	2.5	124.0	-	104.5
14	-	-	3"	CAP972574	(44)	59.0	65.0	120.0	54.0	74.0	2.5	124.0	-	104.5
15	M90	CAP970594	3"	CAP972594	22 (44.0)	66.0	73.0	140.0	63.0	83.0	3.15	133.0	-	121.0
15	-	-	3 1/2"	CAP972694	(45.2)	66.0	73.0	140.0	63.0	83.0	3.15	133.0	-	121.0
16	M90	CAP970504	3"	CAP972504	22 (44.0)	75.0	82.0	140.0	72.0	93.0	3.15	137.0	-	132.0
16	-	-	3 1/2"	CAP972604	(45.2)	75.0	82.0**	140.0	72.0	93.0	3.15	137.0	-	132.0
17	M110	CAP970794	4"	CAP972704	22 (46.5)	85.0	92.0**	200.0	85.0	107.0	3.15	142.0	-	148.5

All dimensions in millimeters unless otherwise noted.

*Aluminum not currently available with UL marine certification.

**Contact Customer Service or your field sales representative for amended UL marine range.

**North American Standards -
Explosionproof**

Gland Type:

Non-armoured barrier

Cable Type:

Non-armoured, armoured and tray cable (does not terminate the armour)

Certifications and Compliances:

- LCIE 97 ATEX 6008X II GD - Exd IIC/Exe II/Ex tD
- IECEX LCI 05.0004X Ex c e IIC/Ex c e II/Ex tD
- cULus Listed for Class I, Zone 2 AEx de II/Ex de II
- UL Marine Listed for Class I, Division 2, Groups A, B, C, D
- NEMA 4X and IP68
- CEPEL EX-558/05X
- GOST-R POCC FR.B03126
- NEPSI N° GYJ071336U & GYJ071337U
- DNV N° E-10892
- ABS approbation:
n° 10-HS 577243-PDA / P1836754-X
- Lloyds

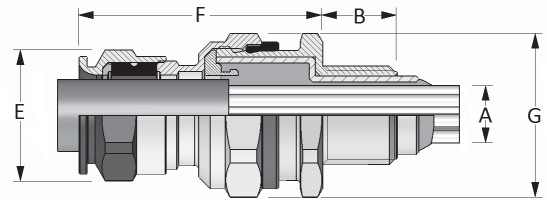

Features:

- Standard material is nickel-plated brass for superior corrosion resistance
- Provides a flameproof and weatherproof seal on outer sheath of cable
- Provides explosionproof compound seal (denoted by red back nut) on conductors
- Deluge boot provides enhanced protection from water ingress
- Standard neoprene seal suitable for use in operating temperatures -60°C (-25°C UL) to 80°C
- Available with metric or NPT threads
- See pages 96–99 for related accessories

ORDERING EXAMPLE:	OPTIONS (replace last digit with option number):
<div style="border: 1px solid black; padding: 5px; display: inline-block;"> CAP01959 4 KX </div>	<ul style="list-style-type: none"> 9 Stainless steel (316L) 8 Bronze 7 Aluminum K1 Includes locknut and fiber washer K2 Includes locknut, fiber washer, earth tag, and shroud
Gland Type	Options

SELECTION TABLE

Gland Size	Entry Thread Size 'A'				Thread Length 'B' Metric (NPT)	Cable Acceptance			Gland Length 'F' (less entry)	Hexagon Dimensions	
	Metric Size	Metric Catalog #	NPT Size	NPT Catalog #		Outer Sheath 'E'		Max No. Cores		Across Flats	Across Corners 'G'
						Min	Max				
4	M16	CAP019594	3/8"	CAP011594	15 (12.0)	4.0	7.5	6.0	46.0	–	20.9
4	M20	CAP019674	1/2"	CAP011674	15 (22.2)	4.0	7.5	6.0	46.0	–	26.4
5	M20	CAP019694	1/2"	CAP011694	15 (22.2)	6.5	11.0	6.0	53.0	–	26.4
6	M20	CAP019604	1/2"	CAP011604	15 (22.2)	9.0	14.5	10.0	59.0	–	33.0
6	M25	CAP019794	3/4"	CAP011794	15 (22.5)	9.0	14.5	10.0	59.0	–	33.0
7	M25	CAP019704	3/4"	CAP011704	15 (22.5)	12.0	19.5	21.0	74.5	–	45.1
7	M32	CAP019894	1"	CAP011894	15 (27.3)	12.0	19.5	21.0	74.5	–	45.1
8	M32	CAP019804	1"	CAP011804	15 (27.3)	17.5	26.0	42.0	83.5	–	52.8
8	M40	CAP019994	1 1/4"	CAP011994	15 (28.0)	17.5	26.0	42.0	83.5	–	52.8
9	M40	CAP019904	1 1/4"	CAP011904	15 (28.0)	23.0	33.0	60.0	92.0	–	60.5
9	M50	CAP019094	1 1/2"	CAP011094	16 (28.5)	23.0	33.0	60.0	92.0	–	60.5
10	M50	CAP019004	2"	CAP011004	16 (29.2)	28.5	41.0	80.0	104.0	–	70.4
10	M63	CAP019204	–	–	16	28.5	41.0	80.0	–	–	73.7
11	M63	CAP019294	2"	CAP011294	17 (29.2)	43.0	48.0	100.0	98.0	–	70.4
12	M63	CAP019274	2"	CAP011204	17 (29.2)	50.0	56.0	100.0	103.0	–	79.2
12	–	–	2 1/2"	CAP011494	42.5	50.0	56.0	100.0	103.0	–	79.2
13	M75	CAP019304	2 1/2"	CAP011404	18 (42.5)	59.0	65.0	120.0	111.0	–	93.5
13	–	–	3"	CAP012504	44	59.0	65.0	120.0	111.0	–	93.5
14	M90	CAP010594	3"	CAP012574	22 (44.0)	66.0	73.0	140.0	120.0	–	104.5
14	–	–	3 1/2"	CAP012604	45.2	66.0	73.0	140.0	120.0	–	104.5
15	M90	CAP010504	3"	CAP012594	22 (44.0)	75.0	82.0	140.0	125.0	–	121.0
15	–	–	3 1/2"	CAP012694	45.2	75.0	82.0**	140.0	125.0	–	121.0
16	M110	CAP010794	4"	CAP012704	22 (46.5)	85.0	92.0**	200.0	128.0	–	132.0

All dimensions in millimeters unless otherwise noted.
*Aluminum not currently available with UL marine certification.
**Contact Customer Service or your field sales representative for amended UL marine range.

4F**CGBS and EBY****North American Standards -
Explosionproof**

CGBS:
 CSA Certified Class I,
 Div. 1, Groups C, D
 Class II, Div. 1 & 2, Groups E, F, G
 Class III

EBY:
 UL, cUL Listed Class I,
 Div. 1, Groups B, C, D
 Class II, Div. 1, Groups F, G

4F

Gland Type:

Portable cord connector

Cable Type:

Non-armoured and tray cable

Certifications and Compliances:

- CSA Certified Class I, Div. 1, Groups C, D
- Class II, Div. 1 & 2, Groups E, F, G
- Class III – CSA File LR13046

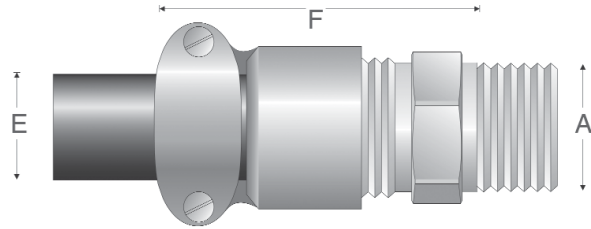
**CGBS Features:**

- Body – steel with zinc electroplate and chromate finish coat
- Gland nut – aluminum
- Body well for Chico A sealing compound (for ordering information please contact customer service)
- Standard neoprene seal suitable for use in operating temperatures -25° to 40°C
- Available with NPT threads

SELECTION TABLE

Entry Thread Size 'A'		Form	Outer Sheath 'E'		Gland Length 'F' (less entry)
NPT Size	NPT Catalog #		Min	Max	
1/2"	CGBS1013	A	0.312	0.437	5/4"
3/4"	CGBS2013	A	0.312	0.437	5/4"
3/4"	CGBS2014	A	0.375	0.500	5/4"
1"	CGBS3015	B	0.500	0.625	2 7/8"
1"	CGBS3016	B	0.625	0.750	2 15/16"
1 1/4"	CGBS4017	B	0.750	0.875	2 13/16"
1 1/4"	CGBS4018	B	0.875	1.000	3 1/2"
1 1/2"	CGBS4019	B	1.000	1.188	3 7/8"

All dimensions in inches unless otherwise noted.

Gland Type:

Portable cord connector

Cable Type:

Non-armoured

Certifications and Compliances:

- UL, cUL Listed Class I, Div. 1, Groups B, C, D
- Class II, Div. 1, Groups F, G – UL File E10279

SELECTION TABLE

Entry Thread Size 'A'		Outer Sheath 'E'	
NPT Size	NPT Catalog #	Min	Max
3/4"	EBY2672	0.250	0.437
3/4"	EBY2682	0.375	0.500
3/4"	EBY26102	0.500	0.625

All dimensions in inches unless otherwise noted.

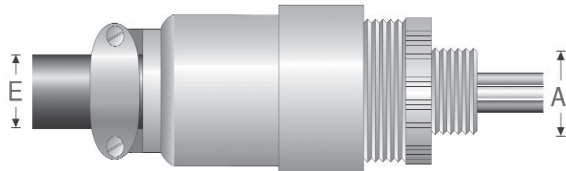
**EBY Features:**

- Standard material is aluminum
- Factory sealed conductors and seal on outer sheath of cable
- Three, 12-inch long, #12 type SF-2 (150°C rating) stranded pigtailed; two circuit wires and one identified grounding wire
- Three pressure connectors for 3-conductor cord, range #18 to #12 AWG
- Standard neoprene seal suitable for use in operating temperatures -25° to 40°C
- Available with NPT threads

**North American Standards -
General Purpose**

Gland Type:

Armoured and TECK armoured

Cable Type:

Metal-clad (interlocked or continuously welded corrugated armoured) and TECK

Certifications and Compliances:

- UL Listed – UL File E36379
- CSA Listed – CSA File LR291
- NEMA 4 and IP56
- Wet locations

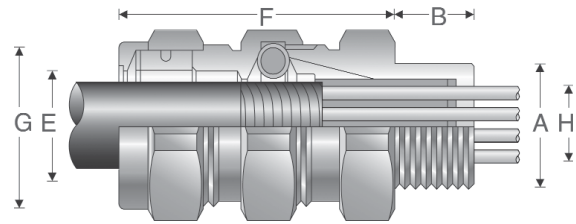

Features:

- Standard material is aluminum
- Stainless steel copper-plated spring provides grounding continuity of cable armour
- Watertight seal on outer sheath of cable
- Standard neoprene seal suitable for use in operating temperatures -25° to 60°C
- Cold Shrink™ Kit is available for extra protection in aggressive environments (see page 102)
- Available with NPT threads
- See page 102 for related accessories

ORDERING EXAMPLE:

TMC165	-BR
Gland Type	Options

OPTIONS (add after gland type):

- BR Brass construction (i.e., TMC285-BR)
- NP Nickel-plate finish (i.e., TMC285-BR-NP)

SELECTION TABLE

Entry Thread Size 'A'		Thread Length 'B' NPT	Cable Acceptance				Gland Length 'F' (less entry)	Hexagon Dimensions	
NPT Size	NPT Catalog #		Armour Range 'H'		Outer Sheath 'E'			Across Flats	Across Corners 'G'
			Min	Max	Min	Max			
1/2"	TMC165	0.750	0.440	0.650	0.490	0.781	2.375	1.250	1.375
3/4"	TMC285	0.781	0.600	0.850	0.650	1.000	2.625	1.500	1.625
1"	TMC3112	0.938	0.800	1.120	0.850	1.313	2.625	1.875	2.000
1 1/4"	TMC4140	0.969	1.100	1.400	1.150	1.625	2.750	2.250	2.438
1 1/2"	TMC5161	0.969	1.330	1.610	1.380	1.781	2.750	2.500	2.75
2"	TMC6206	1.000	1.570	2.060	1.630	2.313	4.500	3.250	3.500
2 1/2"	TMC7247	1.438	1.930	2.470	1.990	2.719	4.750	3.750	4.000
3"	TMC8302	1.438	2.450	3.020	2.525	3.281	4.875	4.500	4.875
3 1/2"	TMC9352	1.625	2.950	3.520	3.025	3.781	5.375	5.000	5.375
4"	TMC10402	1.625	3.500	4.020	3.585	4.281	5.500	5.500	5.875

All dimensions in inches unless otherwise noted.

**North American Standards -
General Purpose**

4F

Gland Type:

Armoured

Cable Type:

TECK armoured

Certifications and Compliances:

- CSA Certified Class II, Div. 1 & 2, Groups E, F, G; Class III - CSA File LR13046
- Type 4 and IP56
- Wet locations

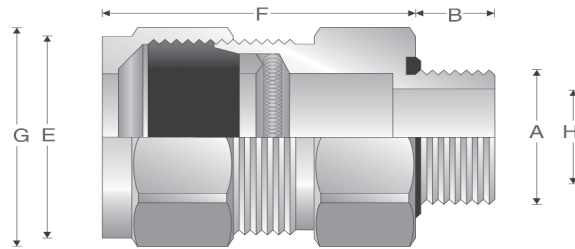

Features:

- Standard material is aluminum
- Stainless steel copper-plated spring provides grounding continuity of cable armour (TECK cable only)
- Watertight seal on outer sheath of cable
- Standard neoprene seal suitable for use in operating temperatures -25° to 60°C
- Cold Shrink™ Kit is available for extra protection in aggressive environments (see page 102)
- An integral o-ring seal on entry threads
- Available with NPT threads
- See page 102 for related accessories

SELECTION TABLE

Aluminum Catalog #	Steel Catalog #	Stainless Steel Catalog #	PVC Catalog #	Entry Thread Size 'A' NPT Size	Thread Length 'B' NPT	Cable Acceptance				Gland Length 'F' (less entry)	Hexagon Dimensions	
						Armour Range 'H'		Outer Sheath 'E'			Across Flats	Across Corners 'G'
						Min	Max	Min	Max			
TECK050 1	TECK050 1S	TECK050 1SS	TECK050 1PVC	1/2"	0.630	0.415	0.570	0.525	0.650	2.300	1.250	1.350
TECK050 2	TECK050 2S	TECK050 2SS	TECK050 2 PVC	1/2"	0.630	0.490	0.680	0.600	0.760	2.300	1.375	1.500
TECK050 3	TECK050 3S	TECK050 3SS	TECK0503PVC	1/2"	0.630	0.615	0.805	0.725	0.885	2.300	1.500	1.600
TECK050 4	TECK050 4S	TECK050 4SS	TECK050 4PVC	1/2"	0.630	0.715	0.905	0.825	0.985	2.300	1.500	1.600
TECK075 5	TECK075 5S	TECK075 5SS	TECK075 5PVC	3/4"	0.630	0.770	0.985	0.880	1.065	2.500	2.000	2.125
TECK075 6	TECK075 6S	TECK075 6SS	TECK075 6PVC	3/4"	0.630	0.915	1.125	1.025	1.205	2.500	2.000	2.125
TECK100 7	TECK100 7S	TECK100 7SS	TECK1007PVC	1"	0.750	1.077	1.295	1.187	1.375	2.625	2.250	2.400
TECK125 8	TECK125 8S	-	TECK125 8PVC	1 1/4"	0.800	1.240	1.545	1.350	1.625	3.500	3.000	3.125
TECK125 9	TECK125 9S	-	TECK125 9PVC	1 1/4"	0.800	1.390	1.545	1.500	1.625	3.400	3.000	3.125
TECK125 10	TECK125 10S	-	TECK125 10PVC	1 1/4"	0.800	1.490	1.795	1.600	1.875	3.500	3.000	3.125
TECK150 11	TECK150 11S	-	TECK150 11PVC	1 1/2"	0.800	1.590	1.885	1.700	1.965	3.800	3.750	3.600
TECK150 12	TECK150 12S	-	TECK150 12PVC	1 1/2"	0.800	1.790	2.107	1.900	2.187	3.900	3.500	3.750
TECK200 13	TECK200 13S	-	TECK200 13PVC	2"	0.825	1.790	2.107	1.900	2.187	4.000	3.750	4.000
TECK200 14	TECK200 14S	-	TECK200 14PVC	2"	0.825	1.990	2.280	2.100	2.375	4.000	3.750	4.000
TECK200 15	TECK200 15S	-	TECK200 15PVC	2"	0.875	2.190	2.485	2.300	2.565	4.000	4.125	4.400
TECK200 16	TECK200 16S	-	TECK200 16PVC	2"	0.875	2.390	2.656	2.500	2.750	4.000	4.125	4.400
TECK250 17	TECK250 17S	-	TECK250 17PVC	2 1/2"	1.300	2.240	2.560	2.380	2.640	5.000	4.500	4.750
TECK250 18	TECK250 18S	-	TECK250 18PVC	2 1/2"	1.300	2.440	2.750	2.580	2.840	5.000	4.500	4.750
TECK300 19	TECK300 19S	-	TECK300 19PVC	3"	1.400	2.640	2.970	2.790	3.060	5.000	4.600	4.900
TECK300 20	TECK300 20S	-	TECK300 20PVC	3"	1.400	2.870	3.190	3.000	3.270	5.000	4.900	5.250
TECK300 21	TECK300 21S	-	TECK300 21PVC	3"	1.400	3.042	3.390	3.210	3.480	5.000	5.000	5.250
TECK350 22	TECK350 22S	-	TECK350 22PVC	3 1/2"	1.400	3.270	3.590	3.420	3.690	5.000	5.600	5.900
TECK350 23	TECK350 23S	-	TECK350 23PVC	3 1/2"	1.400	3.440	3.770	3.610	3.870	5.000	5.500	5.900
TECK400 24	TECK400 24S	-	-	4"	1.400	3.600	3.930	3.810	4.030	5.000	6.125	6.500
TECK400 25	TECK400 25S	-	-	4"	1.400	3.755	4.065	3.965	4.185	5.000	6.125	6.500
TECK400 26	TECK400 26S	-	-	4"	1.400	3.910	4.220	4.120	4.340	5.000	6.125	6.500

All dimensions in inches unless otherwise noted.

North American Standards - General Purpose

Gland Type:

Non-armoured

Cable Type:

Non-armoured and tray cable

Certifications and Compliances:

- cULus Listed - UL File E23223
- Suitable for use in Class I, Div. 2 hazardous locations when installed in accordance with NEC501.10(B)(2)

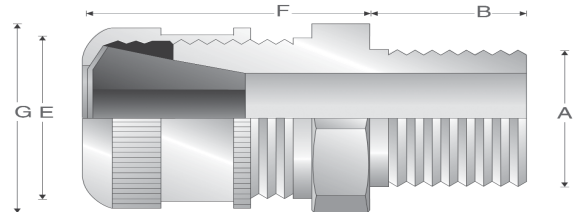

Features:

- Form A - D bodies and gland nuts – steel with zinc electroplate and chromate finish coat
- Form E - F bodies and gland nuts – Feraloy® iron alloy with electrogalvanized and aluminum acrylic paint
- Weatherproof seal on outer sheath of cable
- Standard neoprene seal suitable for use in operating temperatures -25° to 40°C
- Available with NPT threads
- Available in all aluminum construction
- See page 102 for related accessories

ORDERING EXAMPLE:

CGB192	-SG
Gland Type	Options

OPTIONS (add after gland type):

- SG Sealing Gasket* – only applies to certain sizes (e.g., CGB192-SG)
- SA Aluminum Construction† – only applies to certain sizes (e.g., CGB114-SA)

SELECTION TABLE

Entry Thread Size 'A'		Form	Thread Length 'B' NPT	Cable Acceptance		Gland Length 'F' (less entry)	External Diameter 'G'	Hexagon Dimensions	
NPT Size	NPT Catalog #			Outer Sheath 'E'				Across Flats	Across Corners 'G'
				Min	Max				
3/8"	CGB3814	A	0.438	0.125	0.250	1.063	–	0.750	0.875
3/8"	CGB3816	A	0.438	0.250	0.375	1.063	–	0.750	0.875
3/8"	CGB3817	A	0.438	0.375	0.437	1.063	–	0.750	0.875
3/8"	CGB3892	B	0.438	0.125	0.250	1.313	–	1.000	1.188
3/8"	CGB3893	B	0.438	0.250	0.375	1.313	–	1.000	1.188
3/8"	CGB3894	B	0.438	0.375	0.500	1.313	–	1.000	1.188
1/2"	CGB114†	A	0.625†	0.125	0.250	1.000	–	0.875	1.188
1/2"	CGB116†	A	0.625†	0.250	0.375	1.000	–	0.875	1.188
1/2"	CGB117†	A	0.625†	0.375	0.437	1.000	–	0.875	1.188
1/2"	CGB192*†	B	0.750*†	0.125	0.250	1.313	–	1.000	1.188
1/2"	CGB193*†	B	0.750*†	0.250	0.375	1.313	–	1.000	1.188
1/2"	CGB194*†	B	0.750*†	0.375	0.500	1.313	–	1.000	1.188
1/2"	CGB195*†	B	0.750*†	0.500	0.625	1.313	–	1.000	1.188
1/2"	CGB196*	C	0.625*	0.625	0.750	1.750	–	1.500	1.656
1/2"	CGB197*†	C	0.625*†	0.750	0.875	1.750	–	1.500	1.656
3/4"	CGB292†	B	0.625†	0.125	0.250	1.375	–	1.060	1.250
3/4"	CGB293†	B	0.625†	0.250	0.375	1.375	–	1.060	1.250
3/4"	CGB294†	B	0.625†	0.375	0.500	1.375	–	1.060	1.250
3/4"	CGB295†	B	0.625†	0.500	0.625	1.375	–	1.060	1.250
3/4"	CGB296*†	C	0.625*†	0.625	0.750	1.750	–	1.630	1.656
3/4"	CGB297*†	C	0.625*†	0.750	0.875	1.750	–	1.630	1.656
3/4"	CGB298*†	D	0.625*†	0.875	1.000	2.500	2.250	–	–
1"	CGB393†	B	0.688†	0.250	0.375	1.375	–	1.375	1.625
1"	CGB394†	B	0.688†	0.375	0.500	1.375	–	1.375	1.625
1"	CGB395*†	C	0.688*†	0.500	0.625	1.688	–	1.500	1.875
1"	CGB396*†	C	0.688*†	0.625	0.750	1.688	–	1.500	1.875
1"	CGB397*†	C	0.688*†	0.750	0.875	1.688	–	1.500	1.875
1"	CGB3239†	C	0.688†	0.875	1.000	1.688	–	–	1.875
1"	CGB398*†	D	0.625*†	0.875	1.000	2.375	2.375	–	–
1"	CGB399*†	D	0.625*†	1.000	1.188	2.375	2.375	–	–
1"	CGB3911*†	D	0.625*†	1.188	1.375	2.375	2.375	–	–

All dimensions in inches unless otherwise noted.

*With optional Sealing Gasket.

†With optional Aluminum Construction.

North American Standards - General Purpose

4F

Entry Thread Size 'A'		Form	Thread Length 'B' NPT	Cable Acceptance		Gland Length 'F' (less entry)	External Diameter 'G'	Hexagon Dimensions	
NPT Size	NPT Catalog #			Outer Sheath 'E'				Across Flats	Across Corners 'G'
				Min	Max				
1/4"	CGB498	D	0.688	0.875	1.000	2.313	2.250	-	-
1/4"	CGB499	D	0.688	1.000	1.188	2.313	2.250	-	-
1/4"	CGB4911	D	0.688	1.188	1.375	2.313	2.250	-	-
1/4"	CGB4913	E	0.688	1.375	1.625	2.625	3.000	-	-
1/4"	CGB4915	E	0.688	1.625	1.875	2.625	3.000	-	-
1/2"	CGB598	D	0.813	0.875	1.000	2.313	2.250	-	-
1/2"	CGB599	D	0.813	1.000	1.188	2.313	2.250	-	-
1/2"	CGB5911	D	0.813	1.188	1.375	2.313	2.250	-	-
1/2"	CGB5913	E	0.813	1.375	1.625	2.625	3.000	-	-
1/2"	CGB5915	E	0.813	1.625	1.875	2.625	3.000	-	-
2"	CGB6913	E	0.813	1.375	1.625	2.625	3.000	-	-
2"	CGB6915	E	0.813	1.625	1.875	2.625	3.000	-	-
2"	CGB6917	F	0.813	1.875	2.188	2.563	3.750	-	-
2"	CGB6920	F	0.813	2.188	2.500	2.563	3.750	-	-
2 1/2"	CGB7913	E	1.000	1.375	1.625	2.625	3.125	-	-
2 1/2"	CGB7915	E	1.000	1.625	1.875	2.625	3.125	-	-
2 1/2"	CGB7917	F	1.000	1.875	2.188	2.625	3.750	-	-
2 1/2"	CGB7920	F	1.000	2.188	2.500	2.625	3.750	-	-
3"	CGB8917	F	1.000	1.875	2.188	2.625	3.750	-	-
3"	CGB8920	F	1.000	2.188	2.500	2.625	3.750	-	-

**North American Standards -
General Purpose**

Gland Type:

Non-armoured

Cable Type:

Non-armoured and tray cable

Certifications and Compliances:

- cULus Listed - UL File E23223
- Suitable for use in Class I, Div. 2 hazardous locations when installed in accordance with NEC501.10(B)(2)

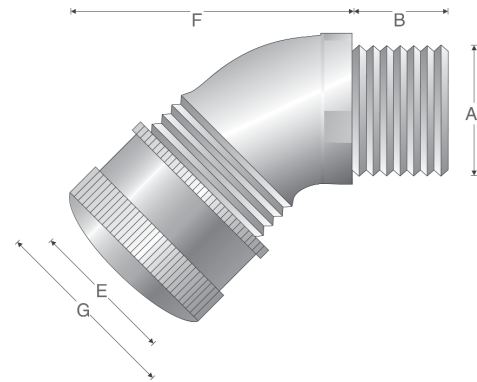

Features:

- 45° angle with male thread
- Standard body material is Feraloy® iron alloy
- Standard gland nut material is steel
- Weatherproof seal on outer sheath of cable
- Standard neoprene seal suitable for use in operating temperatures -25° to 40°C
- Available with NPT threads
- See page 102 for related accessories

SELECTION TABLE

Entry Thread Size 'A'		Thread Length 'B' NPT	Cable Acceptance Outer Sheath 'E'		Gland Length 'F' (less entry)	External Diameter 'G'
NPT Size	NPT Catalog #		Min	Max		
1/2"	CGD192	0.630	0.125	0.250	1.688	1.188
1/2"	CGD193	0.630	0.250	0.375	1.688	1.188
1/2"	CGD194	0.630	0.375	0.500	1.688	1.188
1/2"	CGD195	0.630	0.500	0.625	1.688	1.188
1/2"	CGD196	0.630	0.625	0.750	2.063	1.625
1/2"	CGD197	0.630	0.750	0.875	2.063	1.625
3/4"	CGD292	0.630	0.125	0.250	1.938	1.141
3/4"	CGD293	0.630	0.250	0.375	1.938	1.141
3/4"	CGD294	0.630	0.375	0.500	1.938	1.125
3/4"	CGD295	0.630	0.500	0.625	1.938	1.125
3/4"	CGD296	0.630	0.625	0.750	2.000	1.625
3/4"	CGD297	0.630	0.750	0.875	2.000	1.625

All dimensions in inches unless otherwise noted.

**North American Standards -
General Purpose**

4F

Gland Type:

Non-armoured

Cable Type:

Non-armoured and tray cable

Certifications and Compliances:

- cULus Listed - UL File E23223
- Suitable for use in Class I, Div. 2 hazardous locations when installed in accordance with NEC501.10(B)(2)

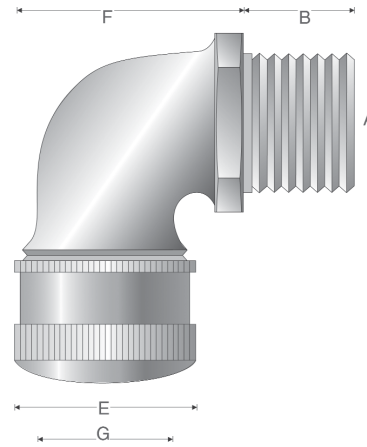

Features:

- 90° angle with male thread
- Standard body material is Feraloy® iron alloy
- Standard gland nut material is steel
- Weatherproof seal on outer sheath of cable
- Standard neoprene seal suitable for use in operating temperatures -25° to 40°C
- Available with NPT threads
- See page 102 for related accessories

SELECTION TABLE

Entry Thread Size 'A'		Thread Length 'B' NPT	Cable Acceptance		Gland Length 'F' (less entry)	External Diameter 'G'
NPT Size	NPT Catalog #		Outer Sheath 'E'			
			Min	Max		
1/2"	CGE192	0.710	0.1250	0.2500	1.438	1.188
1/2"	CGE193	0.710	0.2500	0.3750	1.438	1.188
1/2"	CGE194	0.710	0.3750	0.5000	1.438	1.188
1/2"	CGE195	0.710	0.5000	0.6250	1.438	1.188
1/2"	CGE196	0.710	0.6250	0.7500	2.000	1.625
1/2"	CGE197	0.710	0.7500	0.8750	2.000	1.625
3/4"	CGE292	0.710	0.1250	0.2500	1.406	1.188
3/4"	CGE293	0.710	0.2500	0.3750	1.406	1.188
3/4"	CGE294	0.710	0.3750	0.5000	1.406	1.188
3/4"	CGE295	0.710	0.5000	0.6250	1.406	1.188
3/4"	CGE296	0.710	0.6250	0.7500	1.875	1.625
3/4"	CGE297	0.710	0.7500	0.8750	1.875	1.625
1"	CGE395	0.710	0.5000	0.6250	2.063	1.625
1"	CGE396	0.710	0.6250	0.7500	2.094	1.625
1"	CGE397	0.710	0.7500	0.8750	2.094	1.625
1"	CGE3239	0.710	0.8750	1.0000	2.094	2.250
1"	CGE398	0.710	0.8750	1.0000	2.656	2.250
1"	CGE399	0.710	1.0000	1.1880	2.656	1.625
1"	CGE3911	0.710	1.1880	1.3750	2.656	2.250

All dimensions in inches unless otherwise noted.

**North American Standards -
General Purpose**

Gland Type:

Portable cord connector

Cable Type:

Non-armoured and tray cable

Certifications and Compliances:

- cULus Listed - UL File E23223
- Suitable for use in Class I, Div. 2 hazardous locations when installed in accordance with NEC501.10(B)(2)

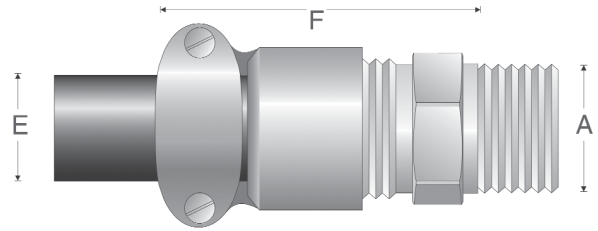

Features:

- Body – steel with zinc electroplate and chromate finish coat
- Gland nut – material is aluminum
- Standard neoprene seal suitable for use in operating temperatures -25° to 40°C
- Available with NPT threads
- See page 102 for related accessories

SELECTION TABLE

Entry Thread Size 'A'		Outer Sheath 'E'		
NPT Size	NPT Catalog #	Min		Max
1/2"	CGB1013	0.312		0.437
1/2"	CGB1014	0.375		0.500
1/2"	CGB1015	0.500		0.625
3/4"	CGB2013	0.312		0.437
3/4"	CGB2014	0.375		0.500
3/4"	CGB2015	0.500		0.625

All dimensions in inches unless otherwise noted.

4F

CGFP

North American Standards - General Purpose

4F

Gland Type:

Non-armoured

Cable Type:

Non-armoured and tray cable

Certifications and Compliances:

- Suitable for use in Class I, Div. 2 hazardous locations when installed in accordance with NEC501.10(B)(2)

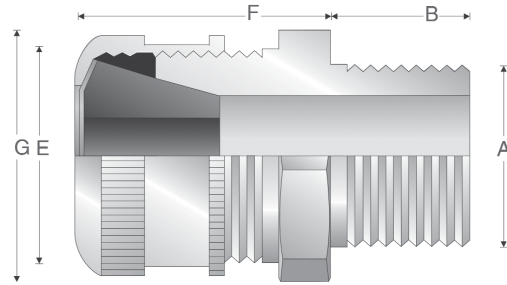

Features:

- Form B - C standard body and gland nut are turned steel
- Form D - G standard body and gland nut are Feraloy® iron alloy
- Weatherproof seal on outer sheath of cable
- Standard neoprene seal suitable for use in operating temperatures -25° to 40°C
- Available with NPT threads
- See page 102 for related accessories

SELECTION TABLE

Entry Thread Size 'A'		Form	Thread Length 'B' NPT	Cable Acceptance Outer Sheath 'E'		Gland Length 'F' (less entry)	External Diameter 'G'
NPT Size	NPT Catalog #			Min	Max		
1/2"	CGFP192	B	0.750	0.1250	0.2500	1.375	1.281
1/2"	CGFP193	B	0.750	0.2500	0.3750	1.375	1.281
1/2"	CGFP194	B	0.750	0.3750	0.5000	1.375	1.281
1/2"	CGFP195	B	0.750	0.5000	0.6250	1.375	1.281
3/4"	CGFP296	C	0.750	0.6250	0.7500	1.750	1.781
3/4"	CGFP297	C	0.750	0.7500	0.8750	1.750	1.781
3/4"	CGFP2239	C	0.750	0.8750	1.0000	1.750	1.781
1"	CGFP396	C	0.938	0.6250	0.7500	1.750	1.781
1"	CGFP397	C	0.938	0.7500	0.8750	1.750	1.781
1"	CGFP3239	C	0.938	0.8750	1.0000	1.750	1.781
1 1/4"	CGFP499	D	0.938	1.0000	1.1880	2.375	2.250
1 1/4"	CGFP4911	D	0.938	1.1880	1.3750	2.375	2.250
1 1/2"	CGFP599	D	0.938	1.0000	1.1880	2.375	2.250
1 1/2"	CGFP5911	D	0.938	1.1880	1.3750	2.375	2.250
2"	CGFP6913	E	1.000	1.3750	1.6250	3.250	3.250
2"	CGFP6915	E	1.000	1.6250	1.8750	3.250	3.250
2 1/2"	CGFP7917	F	1.438	1.8750	2.1880	3.250	3.875
2 1/2"	CGFP7920	F	1.438	2.1880	2.5000	3.250	3.875
3"	CGFP8917	F	1.500	1.8750	2.1880	3.250	3.875
3"	CGFP8920	F	1.500	2.1880	2.5000	3.250	3.875
3 1/2"	CGFP923	G	1.563	2.5000	3.0000	4.250	5.500
3 1/2"	CGFP927	G	1.563	3.0000	3.5000	4.250	5.500
4"	CGFP1023	G	1.625	2.5000	3.0000	4.250	5.500
4"	CGFP1027	G	1.625	3.0000	3.5000	4.250	5.500

All dimensions in inches unless otherwise noted.

**North American Standards -
General Purpose**

Gland Type:

Non-armoured

Cable Type:

Non-armoured and tray cable

Certifications and Compliances:

- cULus Listed - UL File E23223

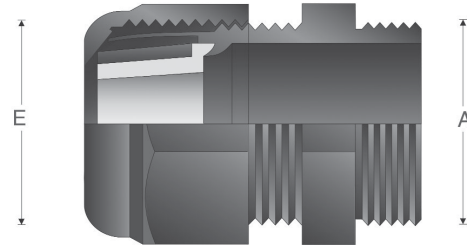

SELECTION TABLE

Entry Thread Size 'A'		Outer Sheath 'E'	
NPT Size	NPT Catalog #	Min	Max
3/8"	NCG38 35	0.10	0.35
1/2"	NCG50 50	0.20	0.50
3/4"	NCG75 75	0.35	0.75
1"	NCG100 100	0.55	1.00

All dimensions in inches unless otherwise noted.



NCG Features:

- Standard material is polyamide 6
- Weatherproof seal on outer sheath of cable
- Standard neoprene seal suitable for use in operating temperatures -25° to 40°C
- Available with NPT threads

**POLYAMIDE LOCK NUT
SELECTION TABLE**

Size	Catalog #
3/8"	10N
1/2"	11N
3/4"	12N
1"	13N

Gland Type:

Non-armoured

Cable Type:

Non-armoured and tray cable

Certifications and Compliances:

- cULus Listed - UL File E23223
- NEMA 3, 4X

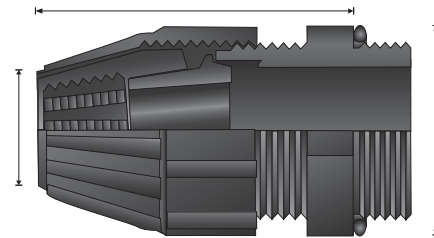

SELECTION TABLE

NPT Size	NPT Catalog #	Cable Acceptance Range 'E'		Gland Length (Less Entry) 'F'	External Diameter 'G'
		Min	Max		
1/2"	NCGB1231	0.25	0.42	2.25	1.33
1/2"	NCGB1232	0.40	0.57	2.25	1.33
3/4"	NCGB2233	0.54	0.68	2.52	1.58
3/4"	NCGB2234	0.64	0.78	2.52	1.58
1"	NCGB3235	0.76	0.91	3.19	2.02
1"	NCGB3236	0.89	1.03	3.19	2.02

All dimensions in inches unless otherwise noted.

NCGB Features:

- Standard material is thermoplastic polyester
- Tightens by hand to create a watertight seal
- Gasket on entry threads included
- Compact design allows close grouping of connectors
- Available with NPT threads

4F Accessories – A Series

4F

A Series – Lock Nut – Standard material is nickel-plated brass

METRIC SELECTION TABLE

Entry Thread	A	B	Catalog #
M16	3	19	CAP221694
M20	4	24	CAP222094
M25	4	30	CAP222594
M32	4.5	36	CAP223294
M40	4.5	46	CAP224094
M50	4.7	65	CAP225094
M63	6.4	80	CAP226394
M75	6.4	95	CAP227594
M90	8	110	CAP229094
M110	12	130	CAP221104

NPT SELECTION TABLE

Entry Thread	A	B	Catalog #
1/2"	3.75	25.4	CAP280124
3/4"	4	33	CAP280134
1"	4.75	40	CAP280144
1 1/4"	5.25	50	CAP280154
1 1/2"	5.75	55.9	CAP280164
2"	6.25	70	CAP280174
2 1/2"	9	90	CAP280184
3"	10	105	CAP280194

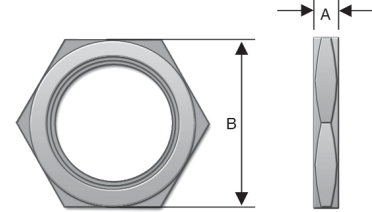

* For stainless steel replace last digit with "9".

A Series – Sealing Washer – Standard material is neoprene

METRIC SELECTION TABLE

Metric Size	Metric Catalog #	Metric Diam. 'D'	Metric Thickness 'E'
10	CAP221049	15.0	1.2
12	CAP221249	18.0	1.2
16	CAP221649	22.0	1.2
20	CAP222049	24.0	1.2
25	CAP222549	30.0	1.5
32	CAP223249	42.0	1.5
40	CAP224049	52.0	1.5
50	CAP225049	63.0	1.5
63	CAP226349	77.0	2.0
-	-	-	-
-	-	-	-

NPT SELECTION TABLE

NPT Size	NPT Catalog #	NPT Diam. 'D'	NPT Thickness 'E'
1/4"	CAP229014	20.0	1.5
3/8"	CAP229038	22.0	1.5
1/2"	CAP229012	27.0	1.5
3/4"	CAP229034	33.0	1.5
1"	CAP229010	41.0	1.5
1 1/4"	CAP229114	52.0	1.5
1 1/2"	CAP229112	57.0	1.5
2"	CAP229020	71.0	2.0
2 1/2"	CAP229212	85.0	2.0
3"	CAP229300	104.0	2.0
3 1/2"	CAP229312	120.0	2.0

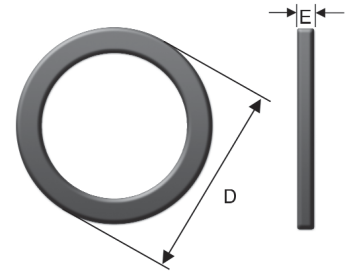

A Series – Earth Tag – Standard material is nickel-plated brass

METRIC SELECTION TABLE

Entry Thread	A	B	C	D	Catalog #
M16	48.75	30	6.75	24.5	CAP567034
M20	53.8	33	7	28.6	CAP567054
M25	61.5	36	10.5	34	CAP567074
M32	73	41	12.2	42	CAP567094
M40	86.5	44.5	13.5	54	CAP567124
M50	111.5	58	13.5	67	CAP567154
M63	125.5	67	13.5	77	CAP567184
M75	137.5	73	13.5	89	CAP567194

NPT SELECTION TABLE

Entry Thread	A	B	C	D	Catalog #
1/2"	61.5	36	10.5	34	CAP567064
3/4"	73	41	12.2	42	CAP567084
1"	73	41	12.2	42	CAP567104
1 1/4"	86.5	44.5	13.5	54	CAP567134
1 1/2"	111.5	58	13.5	67	CAP567154
2"	125.5	67	13.5	77	CAP567174
2 1/2"	137.5	73	13.5	89	CAP567194

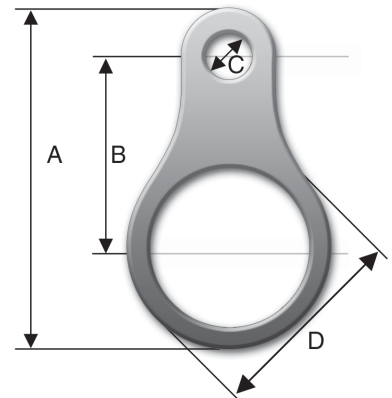

All dimensions in millimeters unless otherwise noted.

A Series – Serrated Lock Washer

– Standard material is stainless steel

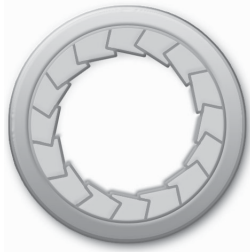

SELECTION TABLE

Metric Size	External Diameter	Catalog #
16	25.5	CAP280069
20	32.5	CAP280029
25	39.5	CAP280259
32	49.5	CAP280329
40	64.5	CAP280409
50	80.5	CAP280509
63	100	CAP280639
75	112	CAP280759
90	123	CAP280099

A-Series – Shroud

– Standard material is PVC



SELECTION TABLE

Gland Size	Catalog #
4	CAP506040
5	CAP506050
6	CAP506060
7	CAP506070
8	CAP506080
9	CAP506090
10	CAP506100
11	CAP506110
12	CAP506120
13	CAP506130
14	CAP506140
15	CAP506150
16	CAP506160

A Series – Clamping Module

– Standard materials are nickel-plated brass body with stainless steel screws and washers

SELECTION TABLE

Cable Range	Gland Size	Across Flats	Width	Thickness	Catalog #
4-8.5	4	15	18	5	CAP810434
6-11	5	19	22	5	CAP810534
8.5-16	6	24	27.5	6	CAP810634
12-21	7	30	33.5	8	CAP810734
16-27.5	8	41	45	8	CAP810834
21-34	9	48	52	9.5	CAP810934
27-41	10	55	59	9.5	CAP811034
33-48	11	64	69	12	CAP811134
40-56	12	72	78	12	CAP811234
47-65	13	85	92	16	CAP811334
54-74	14	95	103	16	CAP811434
63-83	15	110	118	18	CAP811534
72-93	16	120	128	18	CAP811634

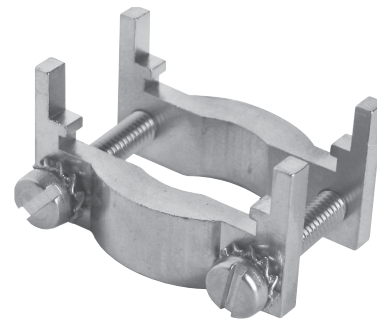

A Series – Earthing Washer – Standard material is brass

METRIC SELECTION TABLE

Gland Size	Lead Sheath Sealing Range		Cable Diameter	Catalog #
	Min	Max		
5	4	7.5	10	CAP560530
6	6	11	13.9	CAP560630
7	9	15	18.3	CAP560730
8	12	20	23.8	CAP560830
9	16	26.5	31	CAP560930
10	21	32.5	38.3	CAP561030
11	28	39.5	45.3	CAP561130
12	33	46.5	52.8	CAP561230
13	40	54.5	60.8	CAP561330
14	46.5	61	71	CAP561430
15	54	72.5	80.5	CAP561530
16	63	81.5	89.5	CAP561630

All dimensions in millimeters unless otherwise noted.



4F Accessories – A Series

4F

A Series – Adaptors and Reducers – Standard material is nickel-plated brass
ATEX Exe Exd with LCIE 98 ATEX 00010

ORDERING EXAMPLE: CAP745334

METRIC x METRIC SELECTION TABLE

Female →

Male	M12	M16	M20	M25	M32	M40	M50	M63	M75	M80	M90	M110
M12		745334										
M16	745834		740274									
M20	745844	740024		740544								
M25		740034	740294		740814							
M32			740304	740564		741084						
M40				740574	740834		741354					
M50					740844	741104		741624				
M63						741114	741374		741894			
M75							741384	741644		745394		
M90									745864			
M110												

METRIC x NPT SELECTION TABLE

Female →

Male	1/4"	3/8"	1/2"	3/4"	1"	1 1/4"	1 1/2"	2"	2 1/2"	3"	3 1/2"
M12	744104										
M16		744194	744694								
M20	744204	744214	744704	744964							
M25			744714	744974	745234						
M32			744724	744984	745244	745504					
M40				744994	745254	745514	745774				
M50					745264	745524	745784	746044			
M63							745794	746054	746314		
M75								746064	746324	746584	
M90										744304	
M110											

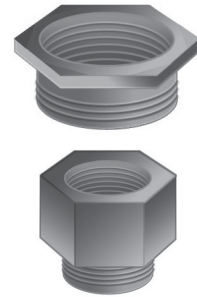

■ Size available – no part number
□ Size not available

NPT x METRIC SELECTION TABLE

Female →

Male	M12	M16	M20	M25	M32	M40	M50	M63	M75	M90	M100	M110
1/4"	740614	740624										
3/8"	740884	740894	740904									
1/2"	740914	740194	740454	740714								
3/4"		740204	740464	740724	740984							
1"			740474	740734	740994	741264	741524					
1 1/4"				740744	741004	741274	741534	741794				
1 1/2"					741104	741284	741544	741804	742064			
2"							741554	741814				
2 1/2"								741824				
3"												
3 1/2"												
4"												

NPT x NPT SELECTION TABLE

Female →

Male	1/4"	3/8"	1/2"	3/4"	1"	1 1/4"	1 1/2"	2"	2 1/2"	3"	3 1/2"	4"
1/4"												
3/8"	745574		744624									
1/2"		745594		745134								
3/4"			744884		745404							
1"			744894	745154		745674						
1 1/4"				745164	745424		745944					
1 1/2"					745434	745694		746214				
2"						745704	745964		746484			
2 1/2"								746234		746504		
3"								746244				
3 1/2"												
4"												

* For stainless steel replace last digit with "9".

A Series – Stopping Plug – Standard material is nickel-plated brass;
ATEX Exe Exd with LCIE 98 ATEX 00010

METRIC SELECTION TABLE

Metric Size	Metric Catalog #*	Across Flats 'A'	Hex Thickness 'B'	Thread Length 'E'
12	CAP190124	14	2.8	15
16	CAP190164	18	3.0	15
20	CAP190204	23	3.0	15
25	CAP190254	28	3.5	15
32	CAP190324	36	4.0	15
40	CAP190404	44	4.0	15
50	CAP190504	54	5.0	16
63	CAP190634	67	5.5	17
75	CAP190754	80	6.0	18
80	CAP190804	85	7.0	20
90	CAP199904	95	8.0	22
100	CAP191004	110	10.0	22

* For stainless steel replace last digit with "9".

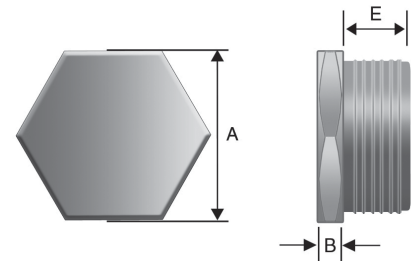

NPT SELECTION TABLE

NPT Size	NPT Catalog #*	Across Flats 'A'	Hex Thickness 'B'	Thread Length 'E'
1/4"	CAP190194	14	2.8	12
3/8"	CAP109294	18	2.8	12
1/2"	CAP190394	22	3.0	16
3/4"	CAP190494	28	3.0	16
1"	CAP190594	36	3.5	20
1 1/4"	CAP190694	44	4.0	20
1 1/2"	CAP190794	50	5.0	20
2"	CAP190894	64	5.5	20
2 1/2"	CAP190994	75	6.0	28
3"	CAP191094	90	6.0	30
3 1/2"	CAP191194	110	10.0	32

All dimensions in millimeters unless otherwise noted.

*For stainless steel replace last digit with "9".

A Series – Nonmetallic Stopping Plug – Standard material is polyamide 6; ATEX certified Ex e II with LCIE 97ATEX6007X

Washer and locknut are required for non-threaded holes (not included) see page 96

POLYAMIDE SELECTION TABLE

Metric Size	Metric Catalog #*	Across Flats 'A'	Hex Thickness 'B'	Thread Length 'E'
12	CAP191127	15	4	15
16	CAP191167	19	4	15
20	CAP191207	23	4	15
25	CAP191257	28	5	15
32	CAP191327	36	5.5	15
40	CAP191407	44	5.5	15
50	CAP191507	54	6	16
63	CAP191637	67	6.5	17

*For stainless steel replace last digit with "9".

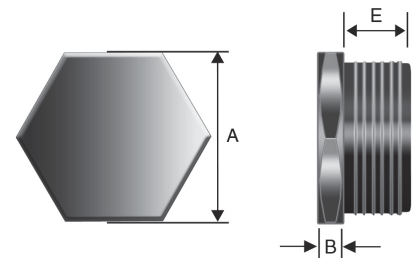

4F Accessories – B Series

4F

B Series – Lock Nut – Standard material is brass

METRIC SELECTION TABLE

Metric Entry Thread	Catalog #
M16	BLN/M16
M20	BLN/M20
M25	BLN/M25
M32	BLN/M32
M40	BLN/M40
M50	BLN/M50
M63	BLN/M63
M75	BLN/M75
M80	BLN/M80
M85	BLN/M85
M90	BLN/M90
M100	BLN/M100

NPT SELECTION TABLE

NPT Entry Thread	Catalog #
1/2"	BLN/050NPT
3/4"	BLN/075NPT
1"	BLN/100NPT
1 1/4"	BLN/125NPT
1 1/2"	BLN/150NPT
2"	BLN/200NPT
2 1/2"	BLN/250NPT
3"	BLN/300NPT
3 1/2"	BLN/350NPT
4"	BLN/400NPT



B Series – Sealing Washer – Standard material is nylon

METRIC SELECTION TABLE

Metric Entry Thread	Catalog #
M16	RNSW/M16
M20	RNSW/M20
M25	RNSW/M25
M32	RNSW/M32
M40	RNSW/M40
M50	RNSW/M50
M63	RNSW/M63
M75	RNSW/M75
M80	RNSW/M80
M85	RNSW/M85
M90	RNSW/M90
M100	RNSW/M100

NPT SELECTION TABLE

NPT Entry Thread	Catalog #
1/2"	RNSW/050NPT
3/4"	RNSW/075NPT
1"	RNSW/100NPT
1 1/4"	RNSW/125NPT
1 1/2"	RNSW/150NPT
2"	RNSW/200NPT
2 1/2"	RNSW/250NPT
3"	RNSW/300NPT
3 1/2"	RNSW/350NPT
4"	RNSW/400NPT



B Series – Earth Tag – Standard material is brass

METRIC SELECTION TABLE

Metric Entry Thread	Catalog #
M16	BET/M16
M20	BET/M20
M25	BET/M25
M32	BET/M32
M40	BET/M40
M50	BET/M50
M63	BET/M63
M75	BET/M75
M80	BET/M80
M85	BET/M85
M90	BET/M90
M100	BET/M100

NPT SELECTION TABLE

NPT Entry Thread	Catalog #
1/2"	BET/050NPT
3/4"	BET/075NPT
1"	BET/100NPT
1 1/4"	BET/125NPT
1 1/2"	BET/150NPT
2"	BET/200NPT
2 1/2"	BET/250NPT
3"	BET/300NPT
3 1/2"	BET/350NPT
4"	BET/400NPT



B Series – Shroud

PVC SELECTION TABLE

Size (Gland Size)	Catalog #
L24 (16, 20s)	PVC-L24
L30 (20)	PVC-L30
L38 (25)	PVC-L38
L46 (32)	PVC-L46
L55 (40)	PVC-L55
L65 (50, 50s)	PVC-L65
L80 (63, 63s)	PVC-L80
L90 (75, 75s)	PVC-L90
L104 (80,85)	PVC-L104
L114 (90, 100)	PVC-L114

PCP SELECTION TABLE

Size	Catalog #
L24 (16, 20s)	PCP-L24
L30 (20)	PCP-L30
L38 (25)	PCP-L38
L46 (32)	PCP-L46
L55 (40)	PCP-L55
L65 (50, 50s)	PCP-L65
L80 (63, 63s)	PCP-L80
L90 (75, 75s)	PCP-L90
L104 (80, 85)	PCP-L104



All dimensions in millimeters unless otherwise noted.

D Series – Lock Nut – Standard material is polyamide

SELECTION TABLE

Metric Entry Diameter	Width	Thickness	Catalog #
M12 x 1.5	17.00	5.00	GHG 960 1941 R0031
M16 x 1.5	22.00	5.00	GHG 960 1941 R0032
M20 x 1.5	26.00	6.00	GHG 960 1941 R0033
M25 x 1.5	32.00	6.00	GHG 960 1941 R0034
M32 x 1.5	41.00	7.00	GHG 960 1941 R0035
M40 x 1.5	50.00	7.00	GHG 960 1941 R0036
M50 x 1.5	60.00	8.00	GHG 960 1941 R0037
M63 x 1.5	75.00	8.00	GHG 960 1941 R0038



D Series – Reducing Ring – Standard material is polyamide

SELECTION TABLE

Thread 1	Thread 2	Length 1	Length 2	Length 3	Across Flats	Catalog #
20 x 1.5	M16 x 1.5	12.00	8.00	8.00	24.00	GHG 960 1946 R0071
25 x 1.5	M20 x 1.5	14.00	8.00	8.00	29.00	GHG 960 1946 R0072
32 x 1.5	M20 x 1.5	16.00	10.00	6.00	36.00	GHG 960 1946 R0056
32 x 1.5	M25 x 1.5	16.00	10.00	10.00	36.00	GHG 960 1946 R0074
40 x 1.5	M25 x 1.5	16.00	10.00	8.00	46.00	GHG 960 1946 R0059
40 x 1.5	M32 x 1.5	16.00	10.00	10.00	46.00	GHG 960 1946 R0077
50 x 1.5	M32 x 1.5	18.00	12.00	10.00	55.00	GHG 960 1946 R0062
50 x 1.5	M40 x 1.5	18.00	12.00	10.00	68.00	GHG 960 1946 R0080
63 x 1.5	M40 x 1.5	18.00	12.00	10.00	68.00	GHG 960 1946 R0065
63 x 1.5	M50 x 1.5	18.00	12.00	12.00	68.00	GHG 960 1946 R0083

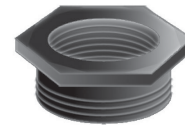

D Series – Screw Plug – Standard material is polyamide

SELECTION TABLE

Thread 1	Diameter	Length 1	Length 2	Catalog #
16 x 1.5	21.50	4.00	12.00	GHG 960 1952 R0111
20 x 1.5	25.50	4.00	13.00	GHG 960 1952 R0112
25 x 1.5	30.50	4.00	13.00	GHG 960 1952 R0113
32 x 1.5	37.50	5.50	15.00	GHG 960 1952 R0114
40 x 1.5	45.50	5.50	15.00	GHG 960 1952 R0115
50 x 1.5	55.50	5.50	16.00	GHG 960 1952 R0116
63 x 1.5	85.00	6.50	16.00	GHG 960 1952 R0117

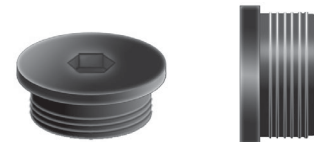

D Series – Blanking Plug – For sealing unused cable glands;
Standard material is polyamide

SELECTION TABLE

Thread 1	Diameter	Length 1	Catalog #
12	6.00	30.30	GHG 960 1944 R0101
16	7.00	33.00	GHG 960 1944 R0102
20	8.50	34.50	GHG 960 1944 R0103
25	11.00	36.00	GHG 960 1944 R0104
32	14.00	39.50	GHG 960 1944 R0105
40	20.00	42.00	GHG 960 1944 R0106
50	26.00	44.00	GHG 960 1944 R0107
63	34.00	45.00	GHG 960 1944 R0108



All dimensions in millimeters unless otherwise noted.

4F Accessories – E Series

4F

E Series – Chico® LiquidSeal

SELECTION TABLE

Std. Carton Qty.	Size (ml.)	Catalog #
10	10 ml.	LSC 10
10	20 ml.	LSC 20
5	50 ml.	LSC 50



E Series – TSC Epoxy Sealing Compound

SELECTION TABLE

Std. Carton Qty.	Tube Size	Catalog #
10	0.5 oz.	TSC05
10	1.0 oz.	TSC1
5	4.0 oz.	TSC4



E Series – Wire Mesh Grip

SELECTION TABLE

Cord Range Diameter	Gland Nut	Wire Mesh Grip Catalog #
.375 to .500	NUT94	RPE417-115
.500 to .625	NUT94	RPE417-116
.500 to .625	NUT95	RPE417-129
.625 to .750	NUT95	RPE417-117
.750 to .875	NUT95	RPE421-119
.875 to 1.000	NUT98	16676N
.875 to 1.000	NUT98	16676N
.875 to 1.000	NUT95	RPE421-120
.875 to 1.000	NUT98	16676N
1.000 to 1.188	NUT98	RPE421-121
1.188 to 1.375	NUT98	RPE433-122
1.375 to 1.625	NUT913	RPE433-123
1.625 to 1.875	NUT913	17317N



E Series – Cold Shrink™ Kit

SELECTION TABLE

Entry Thread	Catalog #
1/2"	TMC-K1
3/4"	TMC-K2
1"	TMC-K3
1 1/4"	TMC-K4
1 1/2"	TMC-K5
2"	TMC-K6
2 1/2"	TMC-K7
3"	TMC-K8
3 1/2"	TMC-K9
4"	TMC-K10

All dimensions in inches unless otherwise noted.

Cold Shrink™ Corrosion Protection Kits are specially designed for Eaton's Crouse-Hinds TMC, TMCX, and TECK fittings to provide protection against corrosive elements like salt spray and moisture. The TMC-K kit is made of a Cold Shrink material that is quick and easy to install on the gland. The Cold Shrink material is made of EPDM rubber that contains no chlorides or sulfurs. The protection kit installs easily over the gland without the use of a heat source to shrink the material tightly over the seal. The Cold Shrink material can be removed easily from the gland by simply cutting it off. See ordering information for complete offering of TMC-K Cold Shrink kits for corrosion protection. Cold Shrink is a registered trademark of the 3M Company.



Breather Drain – SIRA 99 ATEX 3050 U
 I M2 II, 2GD, EExe I & II (Stainless steel & brass only)
 II 2GD, EExe II (Nylon only)
 Enclosure type 4X IP66

SELECTION TABLE

Entry Thread	Material	Catalog #
M20	Brass	DPE1004S3
M20	Stainless Steel	DPE3004S3
M20	Nylon	DPE4004S3
M25	Brass	DPE1005S3
M25	Stainless Steel	DPE3005S3
M25	Nylon	DPE4005S3
1/2"	Brass	DPE1029S3
1/2"	Stainless Steel	DPE3029S3
3/4"	Brass	DPE1030S3
3/4"	Stainless Steel	DPE3030S3

Drainage Plug – Standard material is polyamide; PTB01 ATEX 1128X Ex 1126 Exe II

SELECTION TABLE

Thread 1	Diameter	Length 1	Length 2	Catalog #
M25 x 1.5	30.00	19.00	4.50	GHG 960 1927 R0105

Breathing and Drainage Plug – Standard material is glass-filled polyamide;
 SIRA 99 ATEX 3050 U Ex 1126 Exe II

SELECTION TABLE

Thread 1	Catalog #
M25 x 1.5	GHG 960 1954 R0002

All dimensions in millimeters unless otherwise noted.

Please refer to section 6F for additional breather and drain options.

4F LCC Series Cable Tray Conduit Clamps

4F

Applications:

LCC cable tray conduit clamps are used for installation on cable tray side rails with inside flanges (requiring inside tray mounting) and outside flanges; LCCF clamps are for use exclusively on inside flanges.

LCC/LCCF cable tray conduit clamps:

- Provide a means of clamping metal conduit (rigid steel or aluminum, IMC and EMT) to cable tray to provide for the exit of power and/or control cables from tray
- Provide a means to firmly bond exit conduit to cable tray for best grounding continuity
- Provide strong mechanical support for exit conduits and cables
- Can be used indoors or outdoors, wherever cable tray systems are installed
- Facilitate the safe exit of cables from tray – insure protection of cables from damage

Features:

- Quick and easy installation – low installed cost. Merely tighten clamp nut and/or set screw(s)
- Swivel hook clears conduit. No disassembly required for installation
- No drilling or welding necessary for installation
- Provides superior ground continuity between conduit and cable tray
- Clamps conduit at any angle with relation to tray – facilitates wire pulling, minimizes conduit bending
- Malleable iron body provides great strength
- Knurled body has no-slip surface for conduit and tray – positive grip assured
- Compact design has low profile – minimum tray space required for assembly
- Design accommodates all popular types of cable tray
- Accommodates wide range of conduit sizes – 1/2" through 4"

LCCF features:

- Outside mounting facilitates inside rail installation
- Adjustable hook assures positive grip on inside rail
- Accommodates 3/4" through 1 3/4" wide flange

Certifications and Compliances:

- UL Standard: 467 (Grounding and Bonding Equipment)

Standard Materials:

- Body – cast iron
- Hook – steel
- Set screws and clamping nut – steel
- Hook cap – vinyl

Standard Finishes:

- Cast iron – electrogalvanized and aluminum acrylic paint
- Steel – zinc electroplate
- Vinyl – natural

Conduit Size Ranges:

- 1/2" to 4"

LCC

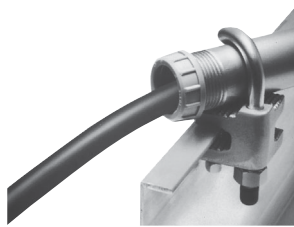

For use with outside rail tray

LCCF

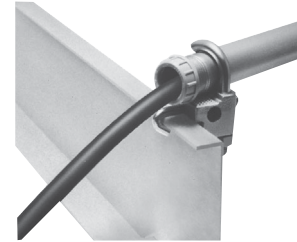

For use with inside rail tray

Ordering Information

Conduit Size	Cat. #	Cat. #
1/2	LCC1	LCCF1
3/4	LCC2	LCCF2
1	LCC3	LCCF3
1 1/4	LCC4	LCCF4
1 1/2	LCC5	LCCF5
2	LCC6	LCCF6
2 1/2	LCC7	LCCF7
3	LCC8	LCCF8
3 1/2	LCC9	LCCF9
4	LCC010	LCCF010

Dimensions In Inches:

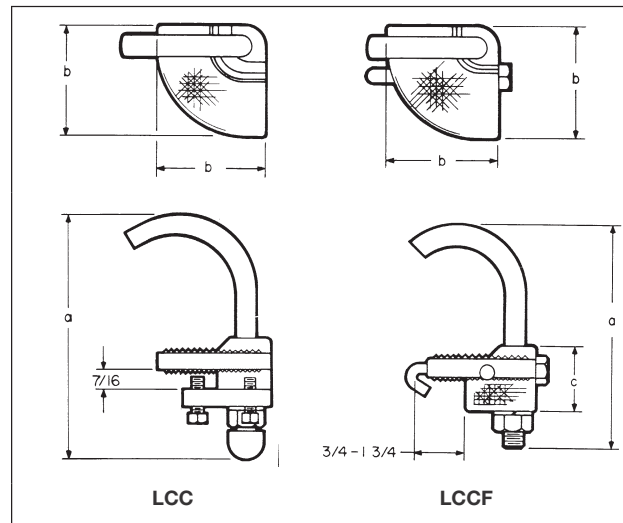

Conduit Size	LCC		LCCF		
	a	b	a	b	c
1/2	3 3/16	1 11/16	3 1/8	1 5/8	1 11/32
3/4	3 7/16	1 11/16	3 11/32	1 5/8	1 11/32
1	3 9/16	1 11/16	3 19/32	1 5/8	1 11/32
1 1/4	4	1 11/16	3 15/16	1 5/8	1 11/32
1 1/2	4 13/16	2 11/16	4 3/4	2 3/4	1 11/16
2	5 5/16	2 11/16	5 1/4	2 3/4	1 11/16
2 1/2	5 13/16	2 11/16	5 3/4	2 3/4	1 11/16
3	6 13/16	3 3/4	6 3/4	3 11/16	2 3/16
3 1/2	7 5/16	3 3/4	7 1/4	3 11/16	2 3/16
4	7 13/16	3 3/4	7 3/4	3 11/16	2 3/16

Applications:

Cable tray grounding conductor clamps are designed for use in heavy industrial applications:

- To provide a means for securely attaching a grounding conductor to cable tray to maintain grounding continuity for the entire cable tray system
- To provide protection of equipment through a reliable method for carrying ground fault currents
- To meet UL and NEC Code requirements
- For installation indoors or outdoors, with most types of cable trays with inside or outside flanges

Ordering Information

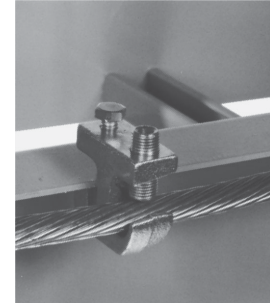
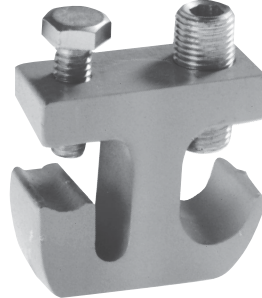

TGC Clamp installs on cable trays with inside or outside flanges

Ground Wire Size	Cat. #
#6 to 3/0	TGC40

Features:

- Meets requirements of NEC Code Article 318-7 for grounding and bonding
- Quick and easy installation – low installed cost. No drilling or special tools required.
- Accommodates solid (where suitable) or stranded aluminum or copper grounding conductors in sizes from #6 to 3/0
- Set screw bonds the clamp to the tray and another set screw securely attaches the grounding conductor to the clamp – outstanding pull-out and vibration resistance
- Design accommodates most popular types of cable tray
- Mechanical device – can be easily inspected
- Malleable iron body provides high strength

Dimensions In Inches:

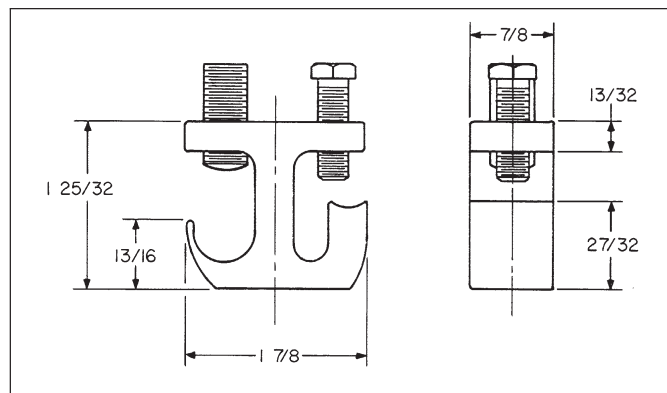

Certifications and Compliances:

- UL Standard: 467 (Grounding and Bonding Equipment)

Standard Materials:

- Body – malleable iron
- Set screws – steel

Standard Finishes:

- Malleable iron and steel – electrogalvanized

4F TW Series THRU-WALL BARRIER® Cable/Conduit Sealing Device

4F

Applications:

THRU-WALL BARRIER cable/conduit sealing device is used wherever there is a need to seal cables or conduits penetrating fire- or non-fire-rated walls, ceilings, floors, bulkheads or decks. For non-fire-rated walls, ceilings, floors, bulkheads or decks, THRU-WALL BARRIER also restricts water and dust and will help contain treated air. THRU-WALL BARRIER is designed:

- To provide a seal for cable/conduit penetrations through masonry, concrete or steel; to restrict the entrance of contaminants through cable/conduit penetrations into clean areas
- For use with most types of power, instrument and control cables as well as conduits
- To be used indoors or outdoors, in new construction or existing structures

Features:

System

- Few parts required to seal a wide range of diameters of cables or conduits
- Easy and fast installation, using factory assembled components
- High degree of flexibility with interchangeable sealing block assemblies and a selection of different sizes of frames

Mounting frame

- One-piece cast malleable iron or steel mounting frame can be cast into concrete during wall construction, grouted in masonry surfaces or welded into steel bulkheads at any time
- Retrofit frame allows for easy installation of frame where cables/conduit are already installed
- Available in sizes to accommodate a wide range of cable tray sizes and loadings, including single and multiple layers of cables for power or instrument applications
- Cast keyways in mounting frame align and position sealing block assemblies
- Frames can be installed in wall such that sealing block assemblies can be inserted in either horizontal or vertical position

Sealing block assembly

- Specially formulated elastomeric material between cast malleable iron pressure plates protects cable from mechanical damage; provides high pull-out resistance and positive cable separation; expands during fire to seal any voids left by burned cable insulation
- Interchangeable sealing block assemblies fit all THRU-WALL BARRIER mounting frames
- Cast stops on front pressure plate prevent sealing block assembly from slipping through mounting frame during installation
- Assemblies are offered for all cable/conduit outside diameters from .250" to 4.500" (6.4 mm to 114.3 mm); cables with diameters less than .250" can be accommodated – consult Eaton's Crouse-Hinds
- Sealing block openings will accommodate undersize and out-of-round cable
- Each sealing block assembly seals multiple cables/conduits; compact design permits close nesting of cables, saving space
- Reducers permit sealing block assemblies to accept cables with smaller O.D. than the specified range
- Plugs are used to fill unused openings in sealing block assemblies; blank sealing block assemblies fill unused spaces in mounting frames, providing for future expansion



Certifications and Compliances:

- ASTM Standard E-119
- NFPA 251
- UL Classification per UL Standard 1479
- USCG Acceptance – consult Eaton's Crouse-Hinds
- NAVSEA Approval – Electric Plant Installation Standard Methods No. S9300- AW-EDG-010/EPISM – TWFS/TWBS assemblies

Standard Materials:

- Mounting frame:
 - TWF, TWFR – cast malleable iron
 - TWFS – cast carbon steel, ASTM A27 Grade 60-30
- Pressure plate – cast malleable iron
- Sealing material – special elastomeric material
- Clamping hardware – steel

Standard Finishes:

- Malleable iron and hardware – electrogalvanized
- Steel – aluminized weldable paint
- Special elastomeric material – natural

Easy three step installation



1. Cast, grout or weld the one-piece mounting frame into masonry or steel surface.

2. Feed cables/conduit through the frame.

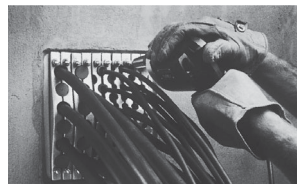

3. Position cables/conduit, insert factory assembled sealing blocks into keyways in mounting frame, and tighten nuts on clamping hardware to effect the seal.

TW Series THRU-WALL BARRIER® Cable/Conduit Sealing Device

4F

Sealing Block Assemblies & Mounting Frames Ordering Information

TWB Sealing Block Assemblies

TWB sealing block assemblies are offered for cable/conduit outside diameters (O.D.) from .250" to 4.500" (6.4 mm to 114.3 mm). Cables with diameters less than .250" can be accommodated – consult Eaton's Crouse-Hinds. Each assembly opening will accommodate a .250" (6.4 mm) O.D. range. When clamping hardware is tightened, the elastomeric material is uniformly compressed around all cable/conduits for a completely tight fit.

Sealing block assemblies are offered for use in marine applications. Each assembly has the required lubrication and sealing gaskets to meet U.S. Navy Hydrostatic Pressure Test Requirements. Assemblies for marine applications are available for cable/conduit outside diameters (O.D.) from .250" (6.4 mm) through 3.500" (88.9 mm). To order, add suffix S to TWB sealing block assembly Cat. No. Example: TWBS4036.



TWB2063

Depending on opening size range, a standard sealing block assembly will seal from one to eleven cables

Opening Size Range	In. mm	.250-.500 6.4-12.7	.500-.750 12.7-19.1	.750-1.000 19.1-25.4	1.000-1.250 25.4-31.8	1.250-1.500 31.8-38.1	1.500-1.750 38.1-44.5	1.750-2.000 44.5-50.8	2.000-2.250 50.8-57.2	2.250-2.500 57.2-63.5
No. Openings In Block		11 11 Added*	6 11 Added*	6	5	4	3	3	3	2
Sealing Block Assembly Cat. #		TWB2111 TWB1111	TWB2062 TWB2112	TWB2063	TWB3054	TWB3045	TWB30355	TWB4036	TWB40366	TWB5027
Frame Spaces Required		2 1	2 2	2	3	3	3	4	4	5
Plug Cat. #		TWP1		TWP3		TWP5		TWP6		TWP7
Reducer Cat. # §		—	TWR2	TWR3	TWR4	TWR5	TWR55	TWR6	TWR66	TWR7

TWF Mounting Frames

TWF(S) mounting frames may be installed either horizontally or vertically. TWFR retrofit frames are used wherever cables/conduits are already installed through a fire- or non-fire-rated wall, floor or ceiling. They are designed with a removable section to permit installation around cables/conduits. TWFR retrofit frames can be grouted into walls, floors, or ceilings, or welded into steel bulkheads or decks. TWFR retrofit frames will perform in the same manner as the one-piece TWF(S) frames.

TWFS steel mounting frames are welded directly into steel bulkheads, decks and prepared sleeves. For marine applications, keeper bars are provided to securely hold TWBS sealing block assemblies in position when installed.

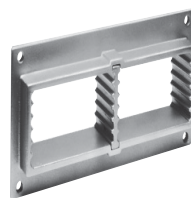

TWF12



TWF6

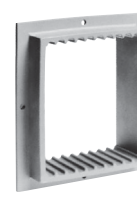

TWF10

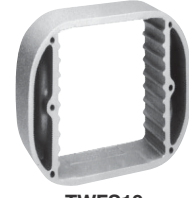

TWFS10

No. of Spaces Available	Frame Cat. #	Retrofit Frame Cat. #	Cast Steel Frame Cat. #
6	TWF6	TWFR6	
10	TWF10	TWFR10	TWFS10
12	TWF12†	TWFR12†	
20	TWF20	TWFR20	TWFS20
24	TWF24	TWFR24	
30	TWF30	TWFR30	TWFS30

†Includes removable partition.

†For 3.5" - 4" cable/conduit – use TWB7011010 assembly and reduce down using TWR reducers.

*Catalog # TWB1111 and TWB2112 are used between TWB2111 and TWB2062 in cases where the number of cables to be sealed in .250-.750 range exceeds the number of openings in standard assemblies. Use as many of these higher density assemblies as needed, sandwiched between halves of a standard assembly.

§TWR reducers match TWB sealing block assemblies shown in column above Cat. No. and reduce openings to accept cable size ranges shown in adjacent column to the left (in direction of arrow).

Crouse-Hinds

by **E•T•N**

4F

TW Series THRU-WALL BARRIER® Cable/Conduit Sealing Device

Plugs, Reducers, Closure Cover Kits, Anchors & Lubricant Ordering Information

4F

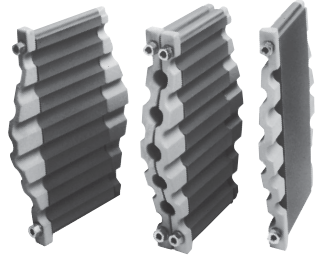

TWB2112 TWB2062

TWP Plugs



TWP plugs will close any unused openings in sealing block assemblies. See table for plug catalog numbers which match specific sealing block assemblies.

TWR Reducers



TWR reducers will reduce openings by .250" (6.4 mm) in sealing block assemblies. See table for reducer catalog numbers which match specific sealing block assemblies. More than one reducer can be used in a single opening.

It is possible to increase cable fill density with double-sided sealing block assemblies (TWB1111 and TWB2112) sandwiched between halves of a standard assembly.

2.500–2.750 63.5–69.9	2.750–3.000 69.9–76.2	3.000–3.250 76.2–82.6	3.250–3.500 82.6–88.9	3.500–4.250† 101.6–108.0	4.250–4.500 108.0–114.3	Blank – No Openings	
2	2	2	2	1	1	None	None
TWB50277	TWB5028	TWB60288	TWB6029	TWB7011010	TWB70111	TWB1	TWB3
5	5	6	6	7	7	1	3
TWP7	TWP8		TWP9	TWP10	TWP11	—	
TWR77	TWR8	TWR88	TWR9 TWR99	TWR1010 TWR10	TWR11	—	

TWB Closure Cover Kits

TWB closure cover kits offer an optional method to close TWF frames installed for future expansion or those that are abandoned. Closure cover kits include two covers clamped to opposite sides of the frame with hardware provided. The insulating material provided is sandwiched between the two covers to maintain the fire rating of the assembly. See table below for closure kit catalog numbers.

No. of Spaces Available	Closure Cover Kit Cat. #*
6	TWB600‡
10	TWB1000
12	TWB600‡
20	TWB2000
24	TWB2400
30	TWB3000

*TWB closure cover kits are not designed to provide a watertight seal in marine/shipboard applications or washdown areas. One kit seals one unused frame opening of same size. Example: use one TWB2000 kit to seal one TWF20, or TWFR20 frame.

‡Use two TWB600 kits to seal one TWF12 or TWFR12 frame opening.

TWK Anchors

TWK anchor assemblies are used to attach mounting frames to wall, ceiling or floor when grouting in frames.

Mounting Type	Cat. #
Flush	TWK1
Recessed	TWK2

TW Series THRU-WALL BARRIER® Cable/Conduit Sealing Device

Ordering Example A

Product Information

Selecting and specifying THRU-WALL BARRIER components is a simple procedure. Primary components for the THRU-WALL BARRIER consist of TWF mounting frames in various sizes and TWB sealing block assemblies for cable/conduit outside diameters (O.D.) in 1/4-inch increments from .250" to 4.500" (6.4 mm to 114.3 mm). Cables with diameters less than .250" can be accommodated – consult Eaton's Crouse-Hinds.

Cable/conduit sizes can be mixed within a sealing block assembly by inserting TWR reducers to accommodate smaller diameters. The use of reducers can decrease the number of sealing block assemblies required. More than one reducer can be used in a single opening.

Another way to increase density is to use TWB1111 and TWB2112 sealing block assemblies wherever there is a large number of cables/conduits in sizes ranging from .250" to .750".

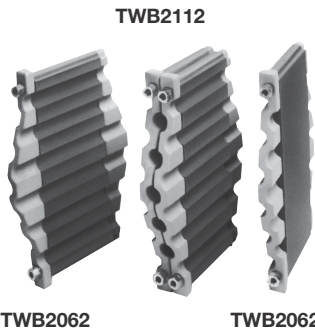

Shown here is a double-sided sealing block assembly (TWB2112) sandwiched between halves of a standard sealing block assembly (TWB2062). Additional double-sided sealing block assemblies may be used to accommodate larger quantities of cables or conduits.

Unused sealing block openings must be closed with TWP plugs. Blank sealing block assemblies TWB1 and TWB3 are used to fill each unused space in the mounting frame and permit future expansion of the system. Typical practice is to include space allowance of 20 to 50% for future expansion. TWB closure kits are used to seal entire frames and permit future system expansion.

Specifying & Ordering

The selection of components is based on the quantity and sizes of cables or conduits going through the penetrations. Once these are known, the sealing block assemblies and frames can be selected.

Step 1. Group cables/conduits by outside diameter (O.D.) and rank from the largest to the smallest.

Step 2. Keeping in mind that sealing block assemblies are available in one-quarter inch increments, group cables/conduits that fall within the same sealing block assembly O.D. size range.

Step 3. Starting with the largest cable/conduit O.D., select the sealing block assemblies required. All openings in each sealing block assembly must be filled.

Specify TWR reducers to accommodate smaller diameter cables where possible and TWP plugs to fill openings not used.

Step 4. Total the frame spaces required for the specified sealing block assemblies and select an appropriate mounting frame(s). Frames are available in 6-, 10-, 12-, 20-, 24- and 30-space sizes. Keep future expansion requirements in mind when specifying frame. Specify blank sealing block assemblies to fill unused mounting frame space and TWB closure cover kits to fill unused frames.

Step 5. Check specification/order to be sure it includes 1) frames, 2) sealing block assemblies, 3) plugs and 4) reducers.

Ordering Example A:

Cable tray size: 24"

Cables specified: 5 power cables – sizes ranging from 1.960" to 2.200" O.D.

Spare capacity required: 50%

Step 1. Group cables by O.D. and rank from largest to smallest.

	Cable Qty.	Cable O.D.
	4	2.200
	1	1.960
Total	5	

Step 2. Group cables that fall within the same sealing block assembly size.

	Cable Qty.	Sealing Block O.D. Range
	4	2.000–2.250
	1	1.750–2.000
Total	5	

Step 3. Starting with the largest cable O.D., select the quantity of sealing block assemblies required. Specify TWR reducers to accommodate smaller

diameter cables where possible and TWP plugs to fill openings not used. (See Example A diagram.)

Note: In the example, one TWR66 reducer is required to accommodate the cable with 1.960 O.D. and one TWP6 plug is required for the unused opening.

Step 4. Total the frame spaces required for sealing block assemblies and select appropriate size mounting frame. Factor in spare capacity required for future expansion.

Total frame spaces required	8
Specification requires 50% spare capacity	4
Total spaces	12

Selection: One TWF12 mounting frame with capacity of 12 spaces. Four TWB1 blank sealing block assemblies to fill unused frame space. (Choice of frame could vary based on future expansion needs and/or specific cable arrangement.)

Sealing Block Assy Cat. #	O.D. Range	Number of Openings	Cables to be Sealed	Number of Openings	Cables to be Sealed
TWB40366	2.000–2.250	3	3	—	4
TWB40366	2.000–2.250	3	2	1	4
Totals		66	5	1	8

Step 5. Bill of materials for specification/order should read:

- (1) TWF12
- (2) TWB40366
- (4) TWB1
- (1) TWR66
- (1) TWP6

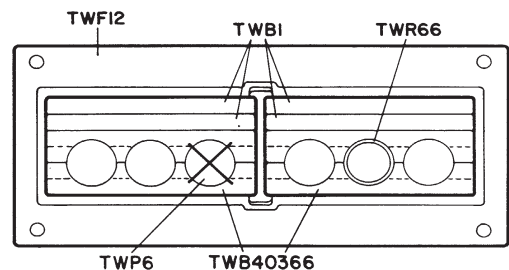

Example A diagram

4F TW Series THRU-WALL BARRIER® Cable/Conduit Sealing Device

Ordering Example B Dimensions

4F

Ordering Example B:

Cable tray size: 24"

Cables specified: 6 power cables – sizes ranging from 2.140" to 2.180" O.D. 31 control cables – sizes ranging from .550" to .945" O.D.

Spare capacity required: 25%

Step 1. Group cables by O.D. and rank from largest to smallest.

Cable Qty.	Cable O.D.
4	2.180
2	2.140
1	.945
4	.890
7	.700
9	.637
10	.550
Total	37

Step 2. Group cables that fall within the same sealing block assembly size.

Cable Qty.	Sealing Block O.D. Range
6	2.000–2.250
5	.750–1.000
26	.500–.750
Total	37

Step 3. Starting with the largest cable O.D., select the quantity of sealing block assemblies required. Specify TWR reducers to accommodate smaller diameter cables where possible and TWP plugs to fill openings not used. (See Example B diagram.)

Sealing Block Assy Cat. #	O.D. Range	Number of Openings	Cables to be Sealed	Openings Not Used	Frame Spaces Required
TWB40366	2.000–2.250	3	3	—	4
TWB40366	2.000–2.250	3	3	—	4
TWB2063	.750–1.000	6	5	1	2
TWB2062	.500–.750	6	6	—	2
TWB2112	.500–.750	11	11	—	2
TWB2112	.500–.750	11	9	2	2
Totals		40	37	3	16

Note: In this example, two TWB2112 sealing block assemblies are sandwiched between two halves of a TWB2062. This dramatically increases cable density in minimum frame space. One TWP3 plug is required for unused opening in TWB2063 and two TWP1 plugs are required for unused openings in the TWB2112.

Step 4. Total the frame spaces required for sealing block assemblies and select appropriate size mounting frame(s). Factor in spare capacity required for future expansion.

Total frame spaces required	16
Specification requires 25% spare capacity	4
Total	20

Selection: Two TWF10 (or one TWF20) mounting frames with total capacity of 20 spaces. One TWB3 and one TWB1 blank sealing block assembly to fill unused frame space. (Choice of frame could vary based on future expansion needs and/or specific cable/conduit arrangement.)

Step 5. Bill of materials for specification/order should read:

- (2) TWF10 or (1) TWF20
- (2) TWB40366
- (1) TWB2063
- (1) TWB2062
- (2) TWB2112
- (1) TWP3
- (2) TWP1
- (1) TWB3
- (1) TWB1

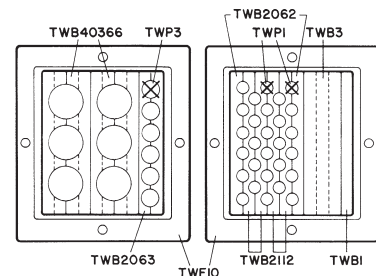

Example B diagram

*For TWFS mounting frame hole dimensions, contact Eaton's Crouse-Hinds ECM field representative or headquarters.

Dimensions In Inches:

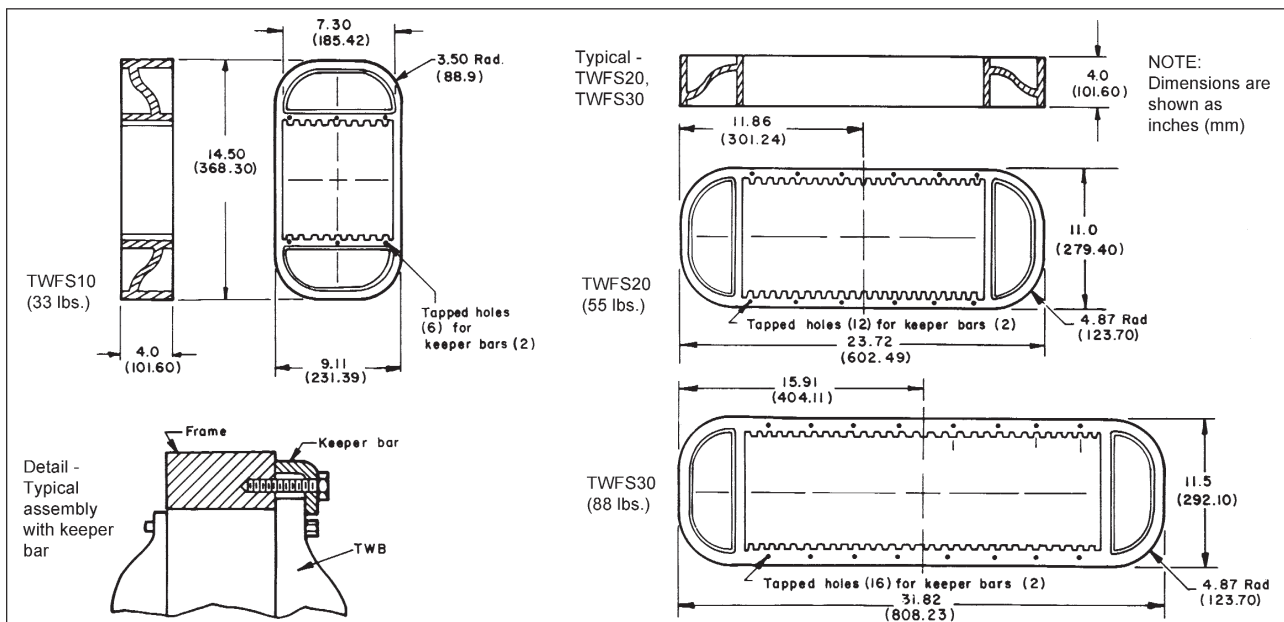

TW Series THRU-WALL BARRIER® Cable/Conduit Sealing Device

4F

Dimensions*

Dimensions In Inches:

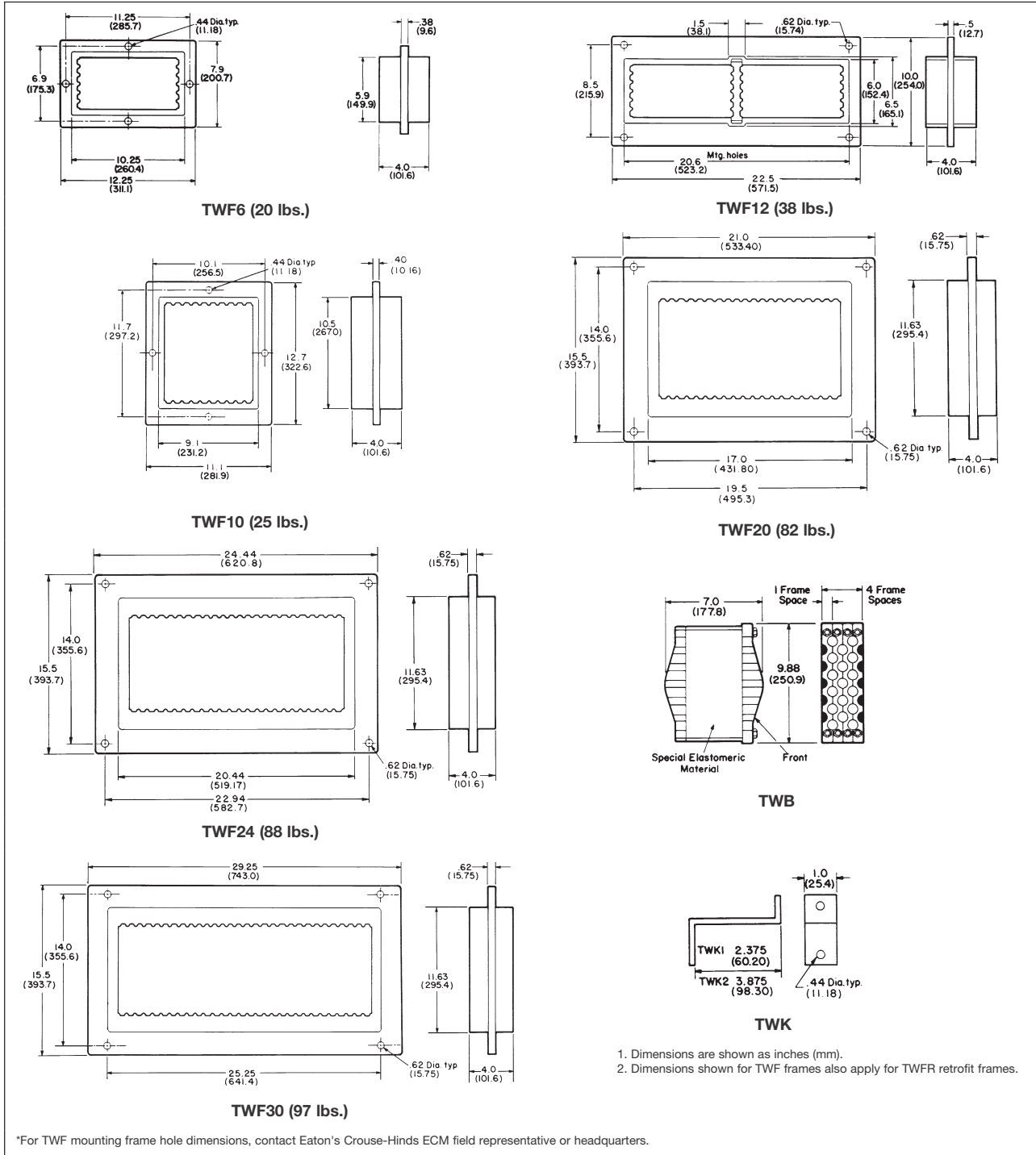

Environmental Seal for Conduit Passing Through Concrete Walls, Floors, or Ceilings

Link-Seal Devices

Applications:

- Eaton's Crouse-Hinds Link-Seal® is the quick, economical way to seal around conduit in concrete walls, floors and casings. Link-Seal is a modular mechanical seal used for any type of penetration.

Features and Benefits:

- Saves time and money – Link-Seal installs in up to 75% less time than competition products
- Positive Hydrostatic Sealing – properly installed, Link-Seal is rated at 20 psig (40 feet of head), which exceeds the performance requirements of most applications
- Environment Seals – Link-Seal environmental seal is designed for long life and use as a permanent seal. Seal elements are specially compounded to resist aging, ozone, sunlight, water and a wide range of chemicals
- Fire Seals – for fire protection in floor and wall penetrations Link-Seal is Factory Mutual approved
- Resistance to high and low temperatures – Link-Seal environmental seal is manufactured from special compounds that resist temperatures from -40°F to +250°F. Link-Seal Fire Seal is manufactured from a silicone material that resists temperatures from -67°F to +400°F
- Corrosion protection – where installation against galvanic corrosion (or electrolysis) is required, Link-Seal provides complete separation pipe and casing. Metal-to-metal contact is eliminated
- Compensates for misalignment – Link-Seal allows for some angular and off-center conduit conditions and still seals effectively
- Absorbs shock, sound and vibration – this inherent benefit of Link-Seal helps reduce conduit failure due to fatigue and threaded connections

Standard Materials:

- Rubber Seal Elements:
EPDM (Black) – Environmental Seals
Silicone (Grey) – Fire Seals
- Pressure Plates:
Glass Reinforced Nylon – Environmental Seals
Steel w/Zinc Dichromate Plate – Fire Seals
- Fasteners:
Carbon Steel, Zinc Dichromate Plate – Environmental Seals
316 Stainless Steel – Environmental with Option S316
Carbon Steel w/Zinc Dichromate – Fire Seals

Environmental Conduit Seal

Ordering Information:

It's easy. Locate the conduit size and type you are installing in the columns on the left. Then locate the seal and sleeve part numbers under the installation method you've selected. No sleeve is needed for cored or cast hole installation.

Cored or Cast Hole Method:

Note the appropriate hole diameter and select the seal part number. Example: For 3/4" EMT conduit through a cored hole – Core a 2" diameter hole and install the conduit using Link-Seal part number LSA200-C-04.

Sleeve Methods:

Select either the plastic or metal sleeve. Both types of sleeves are designed to be cast into concrete walls or floors. Sleeves are ordered separately. Remember to add the wall or floor thickness to the steel sleeve part number to insure the sleeve is provided in the proper length. Plastic sleeves are a standard 16 long and can be modified in the field.

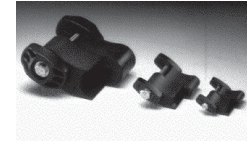
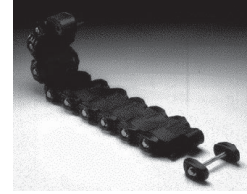

Materials:

The standard product for environmental conduit seals is made from EPDM supplied with steel bolts and nuts with a zinc dichromate finish. These seals are suitable for use in water, direct ground burial and atmospheric conditions. They provide electrical insulation where cathodic protection is required. EPDM rubber is resistant to most inorganic acids and alkalis, and some organic chemicals (acetone, alcohol, ketones).

Options:

To order the standard product with 316 stainless steel bolts and nuts, for corrosive environments, replace the "C" in the seal catalog number with "S316". For example, a 1/2" seal for rigid steel conduit for a cored hole is an LSA200-C-04; ordered with stainless steel bolts and nuts the catalog number becomes LSA200-S316-04.

Environmental Seal for Conduit passing through Concrete Walls, Floors or Ceilings

Ordering Information - Environmental Conduit Seal

Conduit Nominal Size	Conduit Type*	Conduit Actual O.D. (inches)	Cast/Cored Hole Dia. (inches)	Seal for Cast/Cored Hole Cat. #	Plastic Sleeve Cat. #	Seal for Plastic Sleeve Cat. #	Steel Sleeve Cat. #	Seal for Steel Sleeve Cat. #
1/2"	EMT	.706	2.000	LSA275 C 04	LS CS 2 16	LSA200 C 04	WS2 15 ①	LSA275 C 04
1/2"	IMC	.815	2.000	LSA200 C 04	LS CS 2 16	LSA200 C 04	WS2 21 ①	LSA200 C 04
1/2"	RSC	.840	2.000	LSA200 C 04	LS CS 2 16	LSA200 C 04	WS2 21 ①	LSA200 C 04
3/4"	EMT	.922	2.000	LSA200 C 04	LS CS 3 16	LSA315 C 04	WS2 15 ①	LSA200 C 04
3/4"	IMC	1.029	2.500	LSA275 C 06	LS CS 3 16	LSA315 C 04	WS2 15 ①	LSA200 C 04
3/4"	RSC	1.050	2.500	LSA275 C 06	LS CS 3 16	LSA315 C 04	WS2.5 20 ①	LSA275 C 06
1"	EMT	1.163	2.500	LSA315 C 04	LS CS 3 16	LSA300 C 04	WS2.5 20 ①	LSA275 C 06
1"	IMC	1.290	3.000	LSA300 C 04	LS CS 3 16	LSA300 C 04	WS2.5 10 ①	LSA275 C 06
1"	RSC	1.315	3.000	LSA300 C 04	LS CS 3 16	LSA300 C 04	WS2.5 20 ①	LSA200 C 05
1 1/4"	EMT	1.510	3.000	LSA300 C 04	LS CS 3.5 16	LSA315 C 05	WS3.5 22 ①	LSA315 C 05
1 1/4"	IMC	1.638	3.000	LSA275 C 07	LS CS 3.5 16	LSA300 C 05	WS3.5 22 ①	LSA315 C 05
1 1/4"	RSC	1.660	3.000	LSA275 C 07	LS CS 3 16	LSA200 C 06	WS3.5 22 ①	LSA315 C 05
1 1/2"	EMT	1.740	3.500	LSA315 C 05	LS CS 3.5 16	LSA300 C 05	WS3.5 32 ①	LSA315 C 05
1 1/2"	IMC	1.883	3.500	LSA300 C 05	LS CS 3.5 16	LSA275 C 08	WS3.5 22 ①	LSA300 C 05
1 1/2"	RSC	1.900	3.500	LSA300 C 05	LS CS 3.5 16	LSA275 C 08	WS3.5 22 ①	LSA300 C 05
2"	EMT	2.197	4.000	LSA315 C 06	LS CS 4 16	LSA315 C 06	WS4 23 ①	LSA315 C 06
2"	IMC	2.360	4.000	LSA300 C 06	LS CS 4 16	LSA300 C 06	WS4 23 ①	LSA300 C 06
2"	RSC	2.375	4.000	LSA300 C 06	LS CS 4 16	LSA300 C 06	WS4 23 ①	LSA300 C 06
2 1/2"	EMT/RSC	2.875	4.000	LSA200 C 09	LS CS 4 16	LSA200 C 09	WS4 23 ①	LSA200 C 09
2 1/2"	IMC	2.857	4.000	LSA200 C 09	LS CS 4 16	LSA200 C 09	WS4 23 ①	LSA200 C 09
3"	EMT/RSC	3.500	5.000	LSA300 C 08	LS CS 5 16	LSA300 C 08	WS5 25 ①	LSA300 C 08
3"	IMC	3.476	5.000	LSA300 C 08	LS CS 5 16	LSA300 C 08	WS5 25 ①	LSA300 C 08
3 1/2"	EMT/RSC	4.000	6.000	LSA325 C 05	LS CS 6 16	LSA325 C 05	WS6 28 ①	LSA325 C 05
3 1/2"	IMC	3.971	6.000	LSA325 C 05	LS CS 6 16	LSA325 C 05	WS6 28 ①	LSA325 C 05
4"	EMT/RSC	4.500	6.000	LSA300 C 10	LS CS 6 16	LSA300 C 10	WS6 28 ①	LSA300 C 10
4"	IMC	4.466	6.000	LSA300 C 10	LS CS 6 16	LSA300 C 10	WS6 28 ①	LSA300 C 10
5"	RSC	5.563	8.000	LSA425 C 06	LS CS 8 16	LSA425 C 06	WS8 32 ①	LSA425 C 06
6"	RSC	6.625	10.000	LSA475 C 10	LS CS 10 16	LSA475 C 10	WS8 18 ①	LSA300 C 15

*EMT – Electrical Metallic Tubing; IMC – Intermediate Metal Conduit; RSC – Rigid Steel Conduit

①Specify length of steel sleeve in inches. Example: S6-28-08 is 8" long. All plastic sleeves come in standard 16" lengths and can be field cut to desired length.

The last two digits of the seal part number indicate the number of links (and the number of bolts) per seal.

**Fire Seal for
Conduit passing through
Concrete Walls, Floors or Ceilings**

4F

**Fire Conduit Seal
Ordering Information:**

Locate the conduit size and type you are installing in the columns on the left. Then locate the seal and sleeve part number under the installation method you've selected. No sleeve is needed for cored or cast hole installation.

**Cored or Cast Hole
Method:**

Note the appropriate hole diameter and select the seal part number. Example: For 3/4" EMT conduit through a cored hole –Core a 2" diameter hole and install the conduit using Link-Seal Part number LSA200-T-04.

Sleeve Methods:

Select the appropriate metal sleeve for the size and type of conduit being installed. The sleeve should be ordered separately. Remember to add the wall or floor thickness to the steel sleeve part number to insure the sleeve is provided in the proper length.

Materials:

The standard product for fire conduit seals is made from grey silicone supplied with steel bolts and nuts with a zinc dichromate finish. These seals are Factory Mutual approved for use as a 1-hour fire stop and can handle temperature extremes of -67°F to +400°F.

Options:

To order the fire seal for a 3-hour rating, replace the "T" in the seal catalog number with a "FS". For example, a 1/2" seal for rigid steel conduit for a cored hole is an LSA200-T-04; ordered with option FS the catalog number becomes LSA200-FS-04. A 3-hour fire seal can also be made by using two Model T's back-to-back. The Model FS is basically two Model T's back-to-back. In Model FS, a tie rod tightens both seals simultaneously – for use when only one side of an opening is accessible.

Fire Conduit Seal - Ordering Information

Conduit Nominal Size	Conduit Type*	Conduit Actual O.D. (inches)	Cast/Cored Hole Dia. (inches)	Seal for Cast/Cored Hole Cat. #	Steel Sleeve Cat. #	Seal for Steel Sleeve Cat. #
1/2"	EMT	0.706	2.000	LSA275 T 04	WS2 15 ①	LSA275 T 04
1/2"	IMC	0.815	2.000	LSA200 T 04	WS2 21 ①	LSA200 T 04
1/2"	RSC	0.840	2.000	LSA200 T 04	WS2 21 ①	LSA200 T 04
3/4"	EMT	0.922	2.000	LSA200 T 04	WS2 15 ①	LSA200 T 04
3/4"	IMC	1.029	2.500	LSA275 T 06	WS2 15 ①	LSA200 T 04
3/4"	RSC	1.050	2.500	LSA275 T 06	WS2.5 20 ①	LSA275 T 06
1"	EMT	1.163	3.000	LSA315 T 04	WS2.5 20 ①	LSA275 T 06
1"	IMC	1.290	3.000	LSA300 T 04	WS2.5 10 ①	LSA275 T 06
1"	RSC	1.315	3.000	LSA300 T 04	WS2.5 20 ①	LSA200 T 05
1 1/4"	EMT	1.510	3.000	LSA300 T 04	WS3.5 22 ①	LSA315 T 05
1 1/4"	IMC	1.638	3.000	LSA275 T 07	WS3.5 22 ①	LSA315 T 05
1 1/4"	RSC	1.660	3.000	LSA275 T 07	WS3.5 22 ①	LSA300 T 05
1 1/2"	EMT	1.740	3.500	LSA315 T 05	WS3.5 32 ①	LSA300 T 05
1 1/2"	IMC	1.883	3.500	LSA300 T 05	WS3.5 22 ①	LSA300 T 05
1 1/2"	RSC	1.900	3.500	LSA300 T 05	WS3.5 22 ①	LSA275 T 08
2"	EMT	2.197	4.000	LSA315 T 06	WS4 23 ①	LSA315 T 06
2"	IMC	2.360	4.000	LSA300 T 06	WS4 23 ①	LSA300 T 06
2"	RSC	2.375	4.000	LSA300 T 06	WS4 23 ①	LSA300 T 06
2 1/2"	EMT/RSC	2.875	4.000	LSA200 T 09	WS4 23 ①	LSA200 T 09
2 1/2"	IMC	2.857	4.000	LSA200 T 09	WS4 23 ①	LSA200 T 09
3"	EMT/RSC	3.500	5.000	LSA300 T 08	WS5 25 ①	LSA300 T 08
3"	IMC	3.476	5.000	LSA300 T 08	WS5 25 ①	LSA300 T 08
3 1/2"	EMT/RSC	4.000	6.000	LSA325 T 05	WS6 28 ①	LSA325 T 05
3 1/2"	IMC	3.971	6.000	LSA325 T 05	WS6 28 ①	LSA325 T 05
4"	EMT/RSC	4.500	6.000	LSA300 T 10	WS6 28 ①	LSA300 T 10
4"	IMC	4.466	6.000	LSA300 T 10	WS6 28 ①	LSA300 T 10
5"	RSC	5.563	8.000	LSA425 T 06	WS8 32 ①	LSA425 T 06
6"	RSC	6.625	10.000	LSA475 T 10	WS8 18 ①	LSA300 T 15

①Specify length of steel sleeve in inches. Example: WS6-28-08 is 8" long.
*EMT – Electrical Metallic Tubing; IMC – Intermediate Metal Conduit; RSC – Rigid Steel Conduit
The last two digits of the seal part number indicate the number of links (and the number of bolts) per seal.

Dimensions

In Inches:

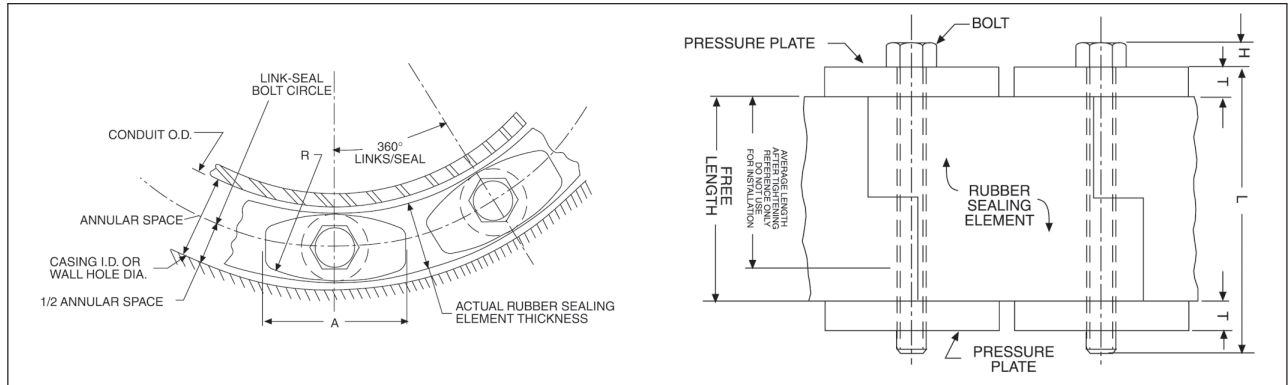

Technical Information

Link-Seal Cat. #	Rubber Sealing Element			Pressure Plate			Bolt			
	Actual Thickness (inches)	Free Length (inches)	Avg. Length After Tightening (inches)	A (inches)	R (inches)	T (inches)	Hex Across Flats	H (inches)	Thread Size (inches)	L
LSA200 C	.478	1¾	1⅝	1⅙	2¼	⅝	M5 slotted hex	.180	M5	2½
LSA275 C	.607	1¾	1⅝	7⁄8	1⅞	5⁄16	M5 slotted hex	.180	M5	2½
LSA300 C	.687	2½	2	1½	2½	7⁄16	½	7⁄32	5⁄16-5⁄18	3½
LSA315 C	.807	2½	2	1⅞	2½	7⁄16	½	7⁄32	5⁄16-5⁄18	3½
LSA325 C	.875	3	2⅞	3⅞	2	½	½	7⁄32	5⁄16-5⁄18	4
LSA425 C	1.062	3½	2¾	3½	3	¾	9⁄16	¼	3⁄8-3⁄16	5
LSA475 C	1.562	3½	2¾	3½	3½	½	9⁄16	¼	3⁄8-3⁄16	4½

4F

4F



Elbows, Couplings, Hubs, Grounding Devices, Plugs, Reducers, Service Entrance and Unions Hazardous and Non-hazardous

5F



Description	Page No.
Application/Selection	see page 118
Elbows	
EL Series	see page 121
FE / FT Series	see page 122
Flexible & Expansion Joint Couplings	
EC Series	see pages 127-128
XD Series	see page 129
XJG Series	see page 130
XJG-EMT Series	see page 131
XJGD Series	see page 132
Grounding Devices, Straps, Clamps	
GC Series	see page 134
Hubs	
HUB Series	see page 133
Pipe Plugs	
PLG Series	see page 124
NOR Series	see page 126
Reducers and Adapters	
AMN / ANM Series	see page 125
RE Series	see page 124
REA Series	see page 124
REC Series	see page 124
NOR Series	see page 126

Description	Page No.
Service Entrance Fittings	
Heads	
F Series	see page 135
Unions	
Non-Expansion	
UNA Series	see page 121
UNF Series	see page 120
UNL Series	see page 120
UNY Series	see page 120
Expansion	
UNF Series	see page 123
UNY Series	see page 123
UNFL Series	see page 123
UNYL Series	see page 123
Nipples	
NOR Series	see page 126
Conduit Liners	
LNR Series	see page 136

5F Elbows, Couplings, Hubs, Grounding Devices, Plugs, Reducers, Service Entrance and Unions

Application and Selection

5F

Applications:

Service entrance heads, elbows, unions, couplings, grounding receptacle and stud and grounding straps with clamps are the miscellaneous fittings needed to complete an electrical conduit system from the overhead service entrance to machinery, lighting fixtures and/or final electrical outlets. These fittings are installed in conduit systems within non-hazardous areas to:

- Plug
- Connect
- Reduce
- Terminate
- Change direction
- Ground

Use in Hazardous Areas:

- Most of the items shown above are also suitable for hazardous areas (see specific listings for compliance information).

Considerations for Selection:

Service Heads:

- Size required – determine from size and number of conductors in service and conduit or mast size.
- Type required – (threaded, slip fit, clamp) – determine from conduit used with service head.

Elbows, Unions, Reducers, Couplings and Grounding Receptacles/Connectors:

- Size required – determine from conduit size.
- Type required – determine from intended function in system (i.e. male and female thread for connecting conduit to outlet box etc.)
- Material and finish required – determine from environmental conditions (corrosive fumes, buried in concrete, etc.)

Options:

Description

Corro-free™ epoxy powder coat

Suffix

S752

Series	Page	Series	Page	Series	Page
--------	------	--------	------	--------	------

F	see page 135	UNL	see page 120	XD	see page 129
---	--------------	-----	--------------	----	--------------

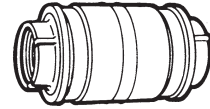
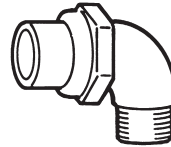
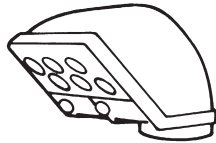

GCT	see page 134	UNF	see page 120	XJG	see page 130
-----	--------------	-----	--------------	-----	--------------

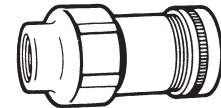
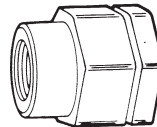
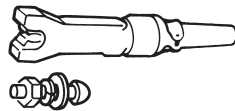

GC	see page 134	EL / FE	see pages 121-122	RE	see page 124
----	--------------	---------	-------------------	----	--------------

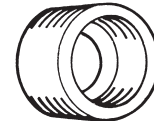
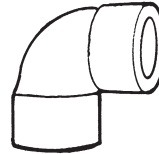

GCR	see page 134	LNR	see page 136	REA / AMN	see page 124
-----	--------------	-----	--------------	-----------	--------------

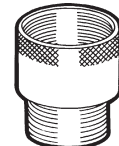
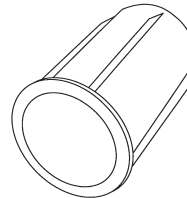
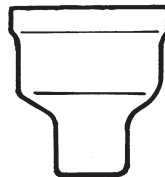

UNYL	see page 123	PLG	see page 124	REC	see page 124
------	--------------	-----	--------------	-----	--------------

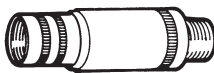

EC	see pages 127-128				
----	-------------------	--	--	--	--

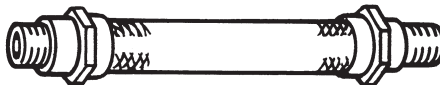

HUB	see page 133				
-----	--------------	--	--	--	--



XJGD	see page 132				
------	--------------	--	--	--	--



XJG-EMT	see page 131				
---------	--------------	--	--	--	--



Elbows, Couplings, Hubs, Grounding Devices, Plugs, Reducers, Service Entrance and Unions

5F

5F

Quick Selector Chart

Series	Description	Size Range	Conduit Type	Standard Materials
XD	Expansion/deflection coupling	1" to 6"	Threaded rigid	<i>Feraloy</i> ® iron alloy hubs, neoprene outer jacket, tinned copper grounding strap
F	Threaded service entrance head	½" to 4" conduit	Threaded rigid	Copper-free aluminum
F	Clamp type service entrance head	¾" to 2" conduit	Threadless rigid or EMT	Copper-free aluminum
GCT	Ground connector and stud	.312" to .406"	Used to provide "quick connect" static electricity grounding connections with portable cable	Bronze connector body; aluminum cable clamp; brass stud
GC100	Grounding strap	50' coil	Used for bonding and grounding	Flexible copper, tinned
GCR	Grounding receptacle	¾" threaded grounding rod	Used to provide static electricity grounding connection	Bronze body, cap and chain; brass grounding stud
GC102	Grounding clamp	Adjustable	Used as clamp for GC100	Brass
HUB	Conduit hub	½" to 4"	Threaded rigid	Steel or <i>Feraloy</i> iron alloy
UNL	Union, 90° angle; for connecting conduit to cast boxes	½" - ½" to ¾" - ¾"	Threaded rigid	<i>Feraloy</i> iron alloy
UNY	Union, male; for connecting conduit to cast boxes	½" to 6" / 20mm to 50mm	Threaded rigid	Steel or <i>Feraloy</i> iron alloy
UNF	Union, female; for connecting conduit to conduit	½" to 6" / 20mm to 50mm	Threaded rigid	Steel or <i>Feraloy</i> iron alloy
UNA Male	Union, 90° to 180° adjustable; for connecting conduit to boxes for conduit support	½" to 1"	Threaded rigid	<i>Feraloy</i> iron alloy
EL-45°	45° elbow, female	12" to 4"	Threaded rigid	<i>Feraloy</i> iron alloy
EL-90°	90° elbow, male; 90° elbow, female; 90° elbow, male and female	½" to 1¼" male; ½" to 2½" female; ½" to 1¼" male and female	Threaded rigid	<i>Feraloy</i> iron alloy
FE	90° elbow, metric	20mm to 25mm	Threaded rigid	Copper-free aluminium
RE	Reducer, threaded	½" - ⅝" to 6" - 5" / 20mm to 50mm	Threaded rigid	Steel or <i>Feraloy</i> iron alloy
REA / AMN	Adapter fitting	½" male to ¾" female; ¾" male to 1" female; 1" male to 1¼" female; 16mm to 63mm	Threaded rigid	Steel or Brass
REC	Reducer coupling	¾" - ½" to 5" - 4"	Threaded rigid	<i>Feraloy</i> iron alloy
PLG	Pipe plug, recessed head or square head	½" to 4" / 20mm to 63mm	Threaded rigid	Steel or <i>Feraloy</i> iron alloy or Brass
EC	Flexible coupling	½" to 4"	See catalog page 7F for details	
LNR	Conduit liner	½" to 4"	Threaded rigid & IMC	Polypropylene
XJG	Expansion fitting	½" to 6"	Threaded rigid or IMC	<i>Feraloy</i> iron alloy
XJG-EMT	Expansion fitting	½" to 4"	EMT	<i>Feraloy</i> iron alloy
XJGD	Expansion-deflection	1" to 4"	Threaded rigid	<i>Feraloy</i> iron alloy

5F Unions and Elbows

Cl. I, Div. 1 & 2, Groups A, B, C, D†
 Cl. II, Div. 1, Groups E, F, G
 Cl. II, Div. 2, Groups F, G
 Cl. III
 Explosionproof
 Dust-Ignitionproof

5F

Applications:

UNY and UNF unions are installed in threaded thickwall conduit systems:

- UNY – to connect conduit to a conduit fitting, junction box or device enclosure
- UNF – to connect conduit to conduit, or to provide a means for future modification of the conduit system

UNA unions are used in conduit and fitting installations when entrance angle is between 90° and 180°.

EL elbows are installed in conduit run or in box or fitting hub:

- To change direction in threaded rigid conduit run by 90°, or when terminating at a box or fitting

Features:

UNY, UNF and UNL unions have:

- Compact design which permits assembly with a minimum of clearance to other adjacent conduit and/or equipment
- Strong and durable construction

UNA unions:

- Have a single clamping nut on angle, making it both a union and a connector
- Permit conduit joints at angles between 90° and 180°

EL elbows have a smooth interior and are both strong and compact.

Certifications and Complies:

<ul style="list-style-type: none"> • NEC/CEC: <p>Class I, Division 1 & 2, Groups A, B, C, D Class II, Division 1, Groups E, F, G Class II, Division 2, Groups F, G Class III EL ½", ¾", 1" UNF/UNY 105, -215, -205, -305 UNL 105, -125, -215, -205</p>
<p>Class I, Division 1 & 2, Groups B, C, D Class II, Division 1, Groups E, F, G Class II, Division 2, Groups F, G Class III UNF/UNY406, -506, -606, -706, -806, -905, -1005</p>
<p>Class I, Division 1 & 2, Groups C, D Class II, Division 1, Groups E, F, G Class II, Division 2, Groups F, G Class III EL, UNF, UNL, UNY - all sizes</p>
<p>Class I, Division 1 & 2, Group D Class II, Division 1, Groups E, F, G Class II, Division 2, Groups F, G Class III UNA</p>

- UL Standard: 1203
- CSA Standard: C22.2 No. 30

†See compliances for classification of each product.

Standard Materials:

- UNY, UNF unions – ½" to 1" – steel
- UNY, UNF unions – 1¼" to 6" – *Feraloy*® iron alloy
- UNL, UNA unions – *Feraloy* iron alloy
- EL elbows – *Feraloy* iron alloy or ductile iron

Standard Finishes:

- Steel – electrogalvanized with chromate treatment
- *Feraloy* iron alloy, malleable iron – electrogalvanized and aluminum acrylic paint

Options:

Description
 Copper-free aluminum
 Not available on UNA or 5" and 6" UNY/UNF

Suffix SA

UNY

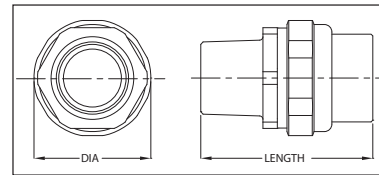

UNL



90° Angle

Size	Cat. #
½ to ½	UNL105
¾ female to ½ male	UNL125
½ female to ¾ male	UNL215
¾ to ¾	UNL205

Dimensions In Inches:

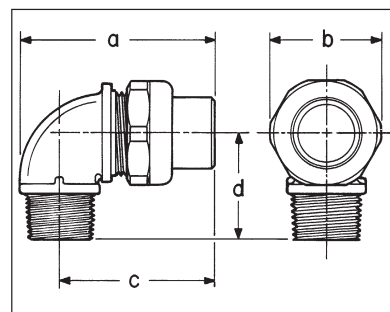

Size	Cat. #	Size	Cat. #
½	UNY105	½	UNF105
½ female to ¾ male	UNY215	¾ to ½	UNF215
¾	UNY205	¾	UNF205
1	UNY305	1	UNF305
1¼	UNY405	1¼	UNF405
1¼	UNY406	1¼	UNF406
1½	UNY505	1½	UNF505
1½	UNY506	1½	UNF506
2	UNY605	2	UNF605
2	UNY606	2	UNF606
2½	UNY705	2½	UNF705
2½	UNY706	2½	UNF706
3	UNY805	3	UNF805
3	UNY806	3	UNF806
3½	UNY905	3½	UNF905
4	UNY1005	4	UNF1005
5	UNY012	5	UNF012
6	UNY014	6	UNF014

UNY			UNF	
Size	Length	Max. Dia.	Length	Max. Dia.
½	2 ⁵ / ₁₆	1½	1 ¹³ / ₁₆	1½
¾ - ½	2 ¹¹ / ₁₆	1 ¹³ / ₁₆	1¾	1 ¹³ / ₁₆
¾	2 ¹¹ / ₁₆	1 ¹³ / ₁₆	1¾	1 ¹³ / ₁₆
1	3	1 ⁷ / ₈	2	1 ⁷ / ₈
1¼	3 ¹ / ₁₆	2¾	2¼	2¾
1½	4¼	3 ¹ / ₁₆	2 ⁵ / ₈	3 ¹ / ₁₆
2	4¼	3 ¹³ / ₁₆	2 ⁹ / ₁₆	3 ¹³ / ₁₆
2½	5 ⁷ / ₁₆	4 ⁵ / ₁₆	3 ³ / ₁₆	4 ⁵ / ₁₆
3	5¾	5 ¹ / ₁₆	3 ⁷ / ₁₆	5 ¹ / ₁₆
3½	6½	5 ¹¹ / ₁₆	4 ⁷ / ₈	5 ¹ / ₁₆
4	6 ⁵ / ₈	6 ³ / ₁₆	4 ⁷ / ₈	6 ¹ / ₁₆
5	6 ¹ / ₈	8 ³ / ₁₆	3 ¹³ / ₁₆	8 ³ / ₁₆
6	6 ¹ / ₈	9 ⁵ / ₁₆	3 ¹³ / ₁₆	9 ⁵ / ₁₆

UNL				
Dim.	105	125	215	205
a	2 ¹¹ / ₁₆	2 ¹¹ / ₁₆	2 ⁷ / ₈	2 ⁷ / ₈
b	1 ¹⁷ / ₃₂	1 ¹³ / ₁₆	1 ¹³ / ₁₆	1 ¹³ / ₁₆
c	2 ¹ / ₁₆	2 ¹ / ₁₆	2 ¹ / ₄	2 ¹ / ₄
d	1 ⁷ / ₁₆	1 ⁷ / ₁₆	1 ⁵ / ₈	1 ⁵ / ₈

Unions and Elbows

Cl. I, Div. 1 & 2, Groups C, D†
 Cl. II, Div. 1, Groups E, F, G
 Cl. II, Div. 2, Groups F, G
 Cl. III

Explosionproof
 Dust-Ignitionproof

5F

UNA

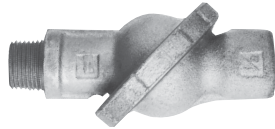

Male (with removable nipple)

Male
 Size

Cat. #

1/2	UNA16
3/4	UNA26
1	UNA36

EL

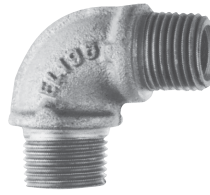

90° Male



45° Female

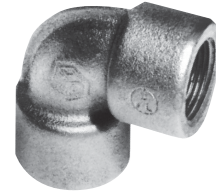

90° Female



90° Male and female

90° Male

Size	Cat. #
1/2	EL195
3/4	EL295
1	EL395

45° Female

Size	Cat. #
1/2	EL1
3/4	EL2
1	EL3
1 1/4	EL4
1 1/2	EL5
2	EL6
2 1/2	EL7
3	EL8
3 1/2	EL9
4	EL10

90° Female

Size	Cat. #
1/2	EL19*
3/4	EL29*
1	EL39*
1 1/4	EL49*
1 1/2	EL59*
2	EL69*
2 1/2	EL79

90° Male and Female

Size	Cat. #
1/2	EL196*
3/4	EL296*
1	EL396*
1 1/4	EL496

*Available in copper free aluminum – add suffix SA to catalog number.

Dimensions In Inches:

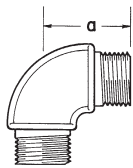

90° Male

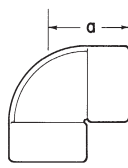

90° Female

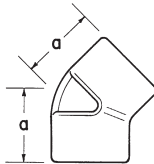

45° Female

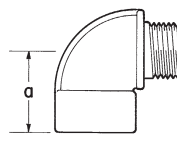

90° Male and female

EL

UNA

Male

Size	Length	Width
1/2	4 ⁵ / ₁₆	2 ⁵ / ₈
3/4	4 ¹³ / ₁₆	2 ⁷ / ₈
1	5 ¹ / ₁₆	3 ¹ / ₂

EL

Size	45° Female	90° Male	90° Female	90° Male & Female
	a	a	a	a
1/2	1 ³ / ₁₆	1 ⁷ / ₁₆	1 ¹⁷ / ₃₂	1 ¹⁷ / ₃₂
3/4	1 ³ / ₈	1 ⁵ / ₈	1 ³ / ₄	1 ⁵ / ₈
1	1 ²¹ / ₃₂	1 ⁷ / ₈	2	1 ⁷ / ₈
1 1/4	1 ³ / ₄		2 ¹ / ₄	2 ¹ / ₈
1 1/2	1 ¹⁵ / ₁₆		4	
2	2 ¹ / ₄		5	
2 1/2	2 ³ / ₄		6 ⁷ / ₁₆	
3	3 ¹ / ₈			
3 1/2	3 ⁷ / ₁₆			
4	3 ⁵ / ₈			

†See compliances for classification of each product.

FE and FT Series

5F

Applications:

FE and FT conduit fittings are installed in hazardous areas to:

- Act as draw-in outlets especially for cables that are stiff due to large size or type of insulation
- Make 90° bends in conduit systems, allowing for a straight pull in either direction
- Provide access to wiring for maintenance and future system changes

Features:

- Maximum volume for bends within a compact overall size
- Large openings to facilitate cable pulling

Certifications and Complies:

Type of Protection

- Ex d, DIP A21, IP67

Degree of Protection

- IP67

Gas Group

- IIB

Approvals

- Ex1108U

Standard Materials:

- Body – Copper-free aluminum
- Cover – Brass

Standard Finishes:

- Natural

Options:

Description

NPT & BSP thread sizes

Suffix

Consult Factory



Ordering Information:

Inspection Elbows and Tees Selection

Cat. #	Type	Entry Size (metric)
FE1	Elbow	M20 (F)-M20 (F)
FE2	Elbow	M25 (F)-M25 (F)
FT1	Tee	M20 (F)-M20 (F)
FT2	Tee	M25 (F)-M25 (F)

Dimensions (mm)

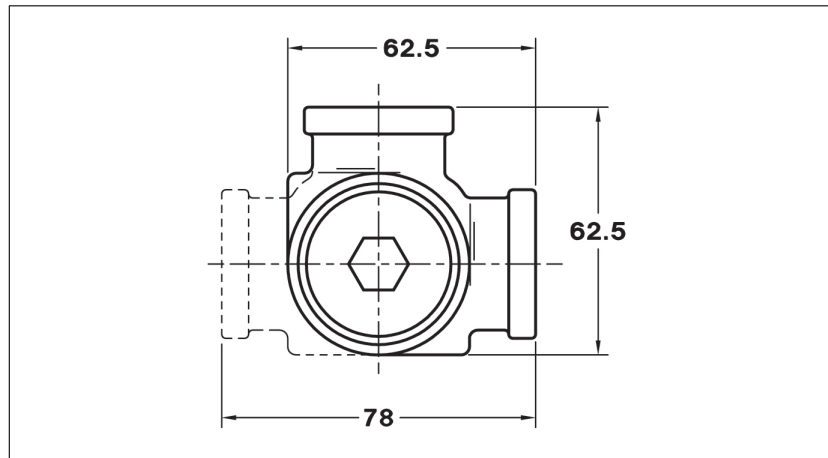

UNF/UNY Expansion Unions

Cl. I, Div. 1 & 2, Groups C, D
 Cl. II, Div. 1, Groups E, F, G
 Cl. II, Div. 2, Groups F, G
 Cl. III

Explosionproof
 Dust-Ignitionproof

5F

Applications:

UNF/UNY expansion unions are designed to be used in all threaded rigid metal† conduit systems indoors and outdoors, in hazardous locations to:

- Connect conduit to conduit
- Connect conduit to a junction box or device enclosure
- Compensate for conduit cut too short
- Allow for expansion and contraction of conduit
- Connect stub-ups to threaded conduit
- Replace sections of conduit runs

Features:

- Compact design
- Internal beryllium copper grounding spring to insure positive grounding continuity.
- Knurled surface on body and sleeve allows secure gripping with wrench.
- Steel construction for maximum strength.
- Available in two styles – short length where space is limited, long length when extra expansion is required.

Certifications and Compliances:

- NEC/CEC:
 - Class I, Division 1 & 2, Groups C, D
 - Class II, Division 1, Groups E, F, G
 - Class II, Division 2, Groups F, G
 - Class III
- UL Standard: 1203
- CSA Standard: C22.2 No. 30

Standard Materials:

- Body and sleeve – steel
- Grounding spring – beryllium copper

Standard Finishes:

- Steel – electrogalvanized with chromate finish
- Beryllium copper – natural

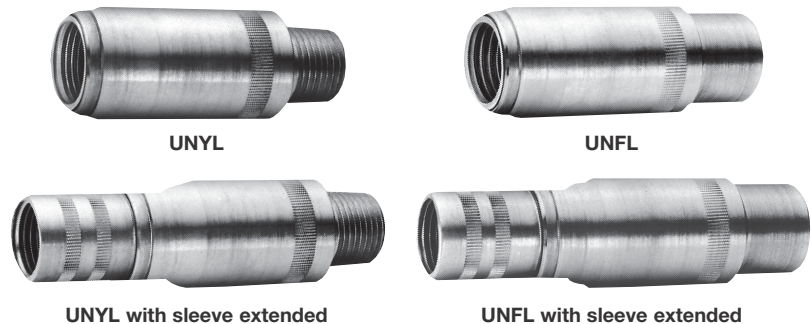

UNY

Male – Short

Conduit Size	Cat. #
1/2	UNY17
3/4	UNY27
1	UNY37

UNYL

Male – Long

Conduit Size	Cat. #
1/2	UNYL17
3/4	UNYL27
1	UNYL37

UNF

Female – Short

Conduit Size	Cat. #
1/2	UNF17
3/4	UNF27
1	UNF37

UNFL

Female – Long

Conduit Size	Cat. #
1/2	UNFL17
3/4	UNFL27
1	UNFL37

Dimensions In Inches:

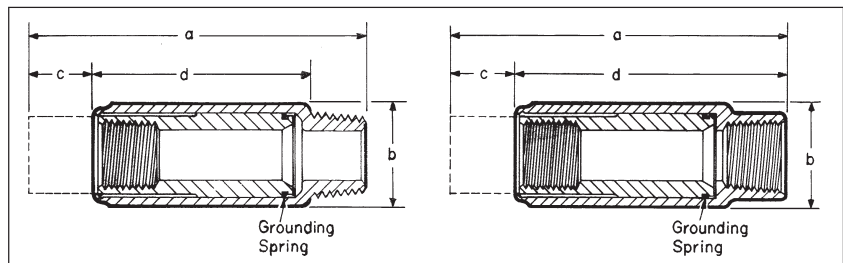

Size	Dimension a*	b	c‡	d
UNY				
1/2	3 ⁵ / ₁₆	1 ³ / ₁₆	1/2	2 ¹ / ₁₆
3/4	3 ⁷ / ₁₆	1 ⁷ / ₁₆	1/2	2 ¹ / ₈
1	3 ¹³ / ₁₆	1 ¹¹ / ₁₆	5/8	2 ¹ / ₄
UNYL				
1/2	4 ⁵ / ₁₆	1 ³ / ₁₆	1	2 ⁹ / ₁₆
3/4	4 ¹ / ₂	1 ⁷ / ₁₆	1 ¹ / ₁₆	2 ¹¹ / ₁₆
1	5 ³ / ₁₆	1 ¹¹ / ₁₆	1 ⁵ / ₁₆	2 ¹⁵ / ₁₆
UNF				
1/2	3 ⁷ / ₁₆	1 ³ / ₁₆	1/2	2 ⁷ / ₁₆
3/4	3 ⁷ / ₁₆	1 ⁷ / ₁₆	1/2	2 ¹⁵ / ₁₆
1	3 ¹³ / ₁₆	1 ¹¹ / ₁₆	5/8	3 ³ / ₁₆
UNFL				
1/2	4 ⁷ / ₁₆	1 ³ / ₁₆	1	3 ³ / ₁₆
3/4	4 ⁹ / ₁₆	1 ⁷ / ₁₆	1 ¹ / ₁₆	3 ¹ / ₂
1	5 ¹ / ₁₆	1 ¹¹ / ₁₆	1 ⁵ / ₁₆	3 ¹³ / ₁₆

*Overall length at maximum expansion

‡Maximum expansion

†Suitable with intermediate Metal Conduit in non-hazardous locations

Crouse-Hinds

by **E.T.N**

5F Reducers, Couplings and Plugs

Cl. I, Div. 1 & 2, Groups A†, B, C, D
 Cl. II, Div. 1, Groups E, F, G
 Cl. II, Div. 2, Groups F, G
 Cl. III

Explosionproof
 Dust-Ignitionproof

5F

Applications:

- RE and REC reducers are used in threaded heavy wall conduit systems.
- RE reduces conduit hubs to a smaller size.
- REA adapters enlarge drilled and tapped openings by 1 NPT size.
- REC connects two different sizes of conduit together or is used to replace a coupling and reducer in an installation.
- PLG plugs are used for closing threaded conduit hubs.

Features:

RE reducers have:

- Integral bushing which prevents damage to wires

- Full, clean cut tapered threads

REC reducers have:

- Integral bushings in both ends which prevents damage to wires
- Funnel shaped interior to guide the wires from large to small conduit, making it easy to pull wire

REA adapters have:

- Smooth integral bushing to protect wire insulation

- Knurled body for easy wrenching

PLG plugs:

- Have clean tapered threads
- Are available in two styles, flush (recessed), or square head type

Certifications and Compliances:

- NEC/CEC:
 - Class I, Division 1 & 2, Groups A, B, C, D
 - Class II, Division 1, Groups E, F, G
 - Class II, Division 2, Groups F, G
 - Class III

(see listings for specific Cat. Nos. suitable for Groups A or B)

- UL Standard: 1203
- CSA Standard: C22.2 No. 30

Standard Materials:

- RE reducers – RE1108 through RE54 in steel; all others in *Feraloy*® iron alloy
- REA adapters – steel
- REC reducers – REC21 and REC32 in steel; all others in *Feraloy* iron alloy
- PLG plugs – Recessed: PLG28-PLG3: steel, PLG4-PLG10: grey iron alloy; Square Head: PLG15-PLG55: steel, PLG65-PLG105: grey iron alloy

Standard Finishes:

- *Feraloy* iron alloy – electrogalvanized and aluminum acrylic paint
- Steel – electrogalvanized with chromate treatment

Options:

Description	Suffix
Copper-free aluminum	SA

RE



Size	Cat. #
1/2 - 1/8	RE1108*
1/2 - 1/4	RE1208*
1/2 - 3/8	RE1308
3/4 - 1/2	RE21†
1 - 1/2	RE31†
1 - 3/4	RE32†
1 1/4 - 1/2	RE41†
1 1/4 - 3/4	RE42†
1 1/4 - 1	RE43†
1 1/2 - 1/2	RE51†
1 1/2 - 3/4	RE52†
1 1/2 - 1	RE53†
1 1/2 - 1 1/4	RE54†
2 - 1/2	RE61†
2 - 3/4	RE62†
2 - 1	RE63†
2 - 1 1/4	RE64†
2 - 1 1/2	RE65†
2 1/2 - 1	RE73†
2 1/2 - 1 1/4	RE74†
2 1/2 - 1 1/2	RE75†
2 1/2 - 2	RE76†
3 - 1	RE83†
3 - 1 1/4	RE84†
3 - 1 1/2	RE85†
3 - 2	RE86†
3 - 2 1/2	RE87†
3 1/2 - 2	RE96†
3 1/2 - 2 1/2	RE97†
3 1/2 - 3	RE98†
4 - 2	RE106†
4 - 2 1/2	RE107†
4 - 3	RE108†
4 - 3 1/2	RE109†
5 - 4	RE01210
6 - 5	RE01412

REC



Large Hub Size	Small Hub Size	Cat. #
3/4	1/2	REC21†
1	1/2	REC31†
1	3/4	REC32
1 1/4	3/4	REC42
1 1/4	1	REC43
1 1/2	3/4	REC52
1 1/2	1	REC53
1 1/2	1 1/4	REC54
2	3/4	REC602
2	1	REC603
2	1 1/4	REC604
2	1 1/2	REC605
2 1/2	1 1/2	REC75
3	2	REC86
3 1/2	2 1/2	REC97*
4	3	REC108*
5	4	REC01210*

REA



Male Hub Size	Female Hub Size	Cat. #
1/2	3/4	REA12†
3/4	1	REA23†
1	1 1/4	REA34†

PLG



Recessed



Square Head

Recessed

Size	Cat. #
1/4	PLG28†
1/2	PLG1†
3/4	PLG2†
1	PLG3†
1 1/4	PLG4
1 1/2	PLG5
2	PLG6
2 1/2	PLG7
3	PLG8
3 1/2	PLG9
4	PLG10

Square Head

Size	Cat. #
1/2	PLG15†
3/4	PLG25†
1	PLG35†
1 1/4	PLG45
1 1/2	PLG55
2	PLG65
2 1/2	PLG75
3	PLG85
3 1/2	PLG95
4	PLG105

*Not available in aluminum.
 †Suitable for use in Class I, Groups A and B areas.

AMN / ANM Adapters For IEC Applications

Zone 1
Zone 2

Zone 21
Zone 22

5F

5F

Application:

Adapters are used to change the thread form and/or size in a wide range of BSP, NPT, and metric cable and conduit entries.

Certifications and Compliances:

- Type of Protection
- Ex d, DIP A21, IP67
- Degree of Protection
- IP66/67
- Gas Group
- IIC
- Approvals
- Ex1108U

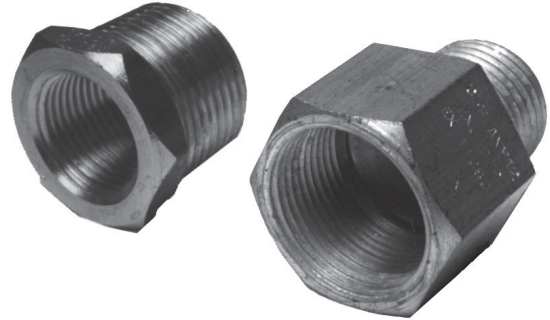

Standard Materials:

- Brass, nickel plated

Standard Finish:

- Natural

Options:

Stainless Steel - Replace NP with SS

Size Ranges:

- Standard sizes listed in table below; other sizes may be available; please consult factory

Notes:

1. Adapters have different size thread at each end
2. Adapters may step up the same type of thread
3. Downwards adapters are Type A; upward or same size adapters are Type B
4. For downward adapters of same thread type, see Reducers Catalog Page
5. For same size and type of thread, see Unions Catalog Page

Ordering Information:

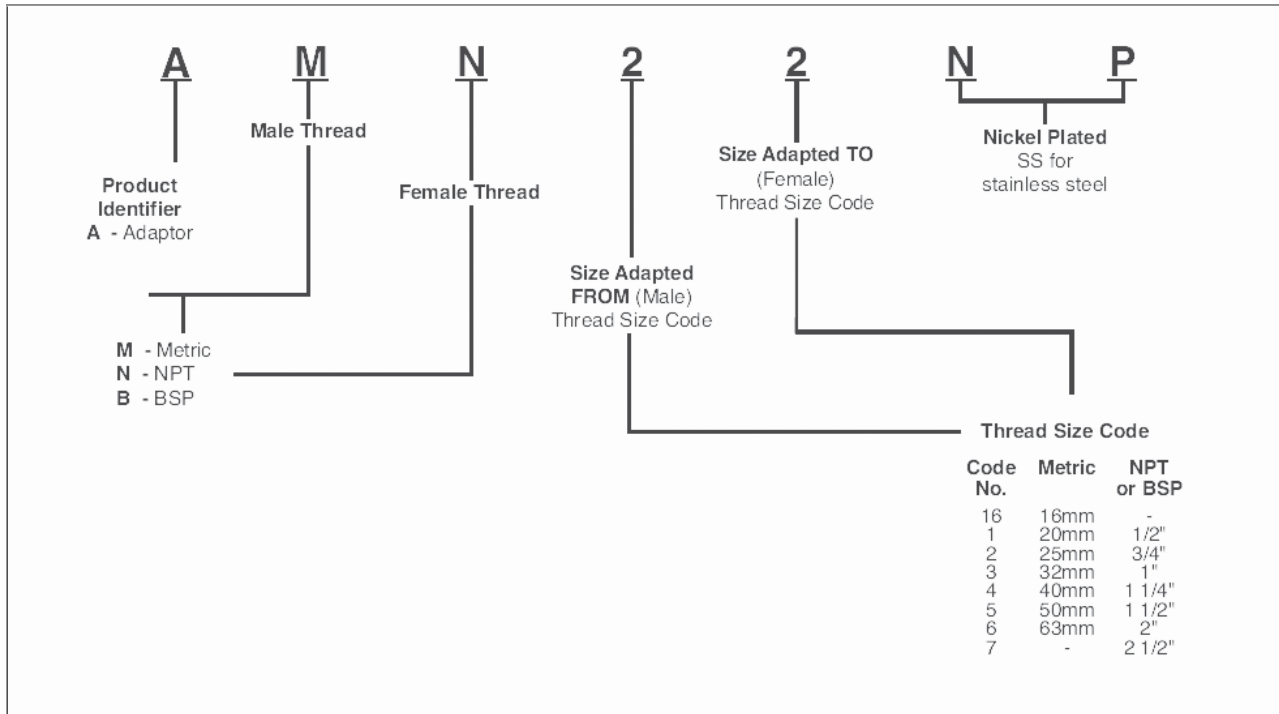

5F

Applications:

- Reducers are used in threaded heavy wall conduit systems to reduce conduit hubs to a smaller size or to connect two different sizes of conduit together
- Adapters enlarge drilled and tapped openings by 1 NPT size
- Plugs are used for closing unused threaded conduit hubs

Features:

Reducers:

- Integral bushing which prevents damage to wires
- Full, clean cut tapered threads
- Funnel shaped interior to guide the wires from large to small conduit, making it easy to pull wire

Adapters:

- Smooth integral bushing to protect wire insulation
- Knurled body for easy wrenching

Plugs:

- Full, clean cut tapered threads

Certifications and Compliances:

- Plugs:
 - Ex II 2 G EEx e II
 - Ex II 2 G EEx d IIC
 - EC-Type examination certificate LOM 02 ATEX 3035U
 - IP67
- Reducers and Adapters:
 - Ex II 2 G EEx e II
 - Ex II 2 G EEx d IIC
 - Ex II 2 D
 - EC-Type examination certificate LOM 03 ATEX 3019U
 - IP67
- Nipples:
 - Ex II 2 G EEx d IIC
 - EC-Type examination certificate LOM 03 ATEX 3019U
 - IP67

Standard Materials:

- Reducers, Adapters, Plugs and Nipples - Zinc Plated Steel



Ordering Information - Reducers

Male Thread	Female Thread	Cat. #
3/4" ISO 7/8	1/2" ISO 7/8	NOR 000 002 190 112
1" ISO 7/8	3/4" ISO 7/8	NOR 000 002 190 188
1/2" ISO 7/8	3/4" ISO 7/8	NOR 000 002 190 675
3/4" ISO 7/8	1" ISO 7/8	NOR 000 002 190 740

Ordering Information - Adapters

Male Thread	Female Thread	Cat. #
M20 x 1.5	1/2" ISO 7/8	NOR 000 112 190 010
PG13	1/2" ISO 7/8	NOR 000 112 190 015
PG16	1/2" ISO 7/8	NOR 000 112 190 014
M20 x 1.5	3/4" ISO 7/8	NOR 000 112 190 009
M25 x 1.5	3/4" ISO 7/8	NOR 000 112 190 008
PG13	3/4" ISO 7/8	NOR 000 112 190 013
PG16	3/4" ISO 7/8	NOR 000 112 190 012
PG21	3/4" ISO 7/8	NOR 000 112 190 011
1/2" ISO 7/8	M20 x 1.5	NOR 000 112 190 002
3/4" ISO 7/8	M20 x 1.5	NOR 000 112 190 001
PG13	M20 x 1.5	NOR 000 112 190 017
PG16	M20 x 1.5A	NOR 000 112 190 016
3/4" ISO 7/8	M25 x 1.5	NOR 000 112 190 000
PG16	M25 x 1.5	NOR 000 112 190 020
1/2" ISO 7/8	PG13	NOR 000 112 190 007
3/4" ISO 7/8	PG13	NOR 000 112 190 005
1/2" ISO 7/8	PG16	NOR 000 112 190 006
3/4" ISO 7/8	PG16	NOR 000 112 190 004
M20 x 1.5	PG16	NOR 000 112 190 018
M25 x 1.5	PG16	NOR 000 112 190 019
3/4" ISO 7/8	PG21	NOR 000 112 190 003



Ordering Information - Plugs

Thread Size	Cat. #
1/2" ISO 7/8	NOR 000 002 140 117
3/4" ISO 7/8	NOR 000 002 140 125
1" ISO 7/8	NOR 000 002 140 133
1" NPT	NOR 000 002 140 365
M20 x 1.5	NOR 000 002 140 655
M25 x 1.5	NOR 000 002 140 656
M32 x 1.5	NOR 000 002 140 657
M50 x 1.5	NOR 000 002 140 658
M60 x 1.5	NOR 000 002 140 659

Type PLG

Ordering Information - Nipples

Thread Size	Type	Cat. #
1/2" ISO 7/8	EMM 1	NOR 000 002 130 118
3/4" ISO 7/8	EMM 2	NOR 000 002 130 126
1" ISO 7/8	EMM 3	NOR 000 002 130 134
1/2" ISO 7/8	EMF 1	NOR 000 002 130 217
3/4" ISO 7/8	EMF 2	NOR 000 002 130 225
1" ISO 7/8	EMF 3	NOR 000 002 130 233

Couplings

Cl. I, Groups A, B, C, D
Cl. II, Groups E, F, G
Cl. III

Explosionproof
Dust-Ignitionproof
Wet Locations

5F

1/2"-2" Brass Construction
2-1/2"-4" Stainless Steel construction only

Applications:

EC couplings are used:

- In hazardous areas where a flexible member is required in a conduit system to accomplish difficult bends, or to allow for movement or vibration of connected equipment or units

Features:

- Rugged design to withstand explosive pressure (Class I)
- Mechanical abuse
- Liquid-tight for wet locations
- For use where lack of space makes use of rigid conduit difficult
- Wire duct liner in sizes 1/2" to 2" insulates against grounds and burn-through from short circuit
- No bonding jumpers required, metallic braid provides continuous electrical path
- ECGJH combination has two threaded male end fittings
- ECLK combination has one female union and one male threaded end fitting

Certifications and Compliances:

- NEC:
 - 1/2" and 3/4" (Brass and S516) – Class I, Division 1, Groups A, B, C, D
 - 1" to 2" (Brass and S516) – Class I, Division 1, Groups C, D
- All sizes also for use in Class II, Division 1, Groups E, F, G and Class III
- UL Standard: 1203
- ATEX and IECEx - **ECGJH S516 Only**:
 - 1/2" and 3/4" (4" to 36" flexible length only) – Ex d IIC, IP66
 - 1", 1 1/4", 1 1/2", 2" (4" to 36" flexible length only) – Ex d IIB, IP66

Standard Materials and Finishes:

- End fittings:
 - 1/2" to 2" – forged brass; natural
 - 2 1/2" to 4" – stainless steel; natural
- Female unions:
 - 1/2" to 1" – steel; electrogalvanized with chromate treatment
 - 1 1/4" to 4" – *Feraloy*® iron alloy; electrogalvanized with aluminum acrylic paint
- 1/2" to 2" have bronze braid covering and flexible brass inner core; packing is woven cotton braid impregnated with asphalt
- 2 1/2" to 4" have a Type 304 stainless steel braid

Options:

Description

All stainless steel (available for ECGJH only)

For severely corrosive locations, a flexible PVC protective coating will be supplied

Special coupling lengths available up to 144 inches. To order, change last two digits in any standard catalog number to the two or three digit length desired in whole inches i.e. To order a 3/4" trade size 110 inches long, use catalog number ECGJH2110.



ECGJH (Male connections both ends)

Flexible Length (In.)	Size	Cat. #	Flexible Length (In.)	Size	Cat. #	Flexible Length (In.)	Size	Cat. #
4	1/2	ECGJH14	18	1	ECGJH318	27	2 1/2	ECGJH727
4	3/4	ECGJH24	18	1 1/4	ECGJH418	27	3	ECGJH827
6	1/2	ECGJH16	18	1 1/2	ECGJH518	27	4	ECGJH1027
6	3/4	ECGJH26	18	2	ECGJH618	30	1/2	ECGJH130
6	1	ECGJH36	18	2 1/2	ECGJH718	30	3/4	ECGJH230
8	1/2	ECGJH18	18	3	ECGJH818	30	1	ECGJH330
8	3/4	ECGJH28	18	4	ECGJH1018	30	1 1/4	ECGJH430
8	1	ECGJH38	21	1/2	ECGJH121	30	1 1/2	ECGJH530
10	1/2	ECGJH110	21	3/4	ECGJH221	30	2	ECGJH630
10	3/4	ECGJH210	21	1	ECGJH321	30	2 1/2	ECGJH730
10	1	ECGJH310	21	1 1/4	ECGJH421	30	3	ECGJH830
12	1/2	ECGJH112	21	1 1/2	ECGJH521	30	4	ECGJH1030
12	3/4	ECGJH212	21	2	ECGJH621	33	1/2	ECGJH133
12	1	ECGJH312	21	2 1/2	ECGJH721	33	3/4	ECGJH233
12	1 1/4	ECGJH412	21	3	ECGJH821	33	1	ECGJH333
12	1 1/2	ECGJH512	21	4	ECGJH1021	33	1 1/4	ECGJH433
12	2	ECGJH612	24	1/2	ECGJH124	33	1 1/2	ECGJH533
12	2 1/2	ECGJH712	24	3/4	ECGJH224	33	2	ECGJH633
12	3	ECGJH812	24	1	ECGJH324	33	2 1/2	ECGJH733
12	4	ECGJH1012	24	1 1/4	ECGJH424	33	3	ECGJH833
15	1/2	ECGJH115	24	1 1/2	ECGJH524	33	4	ECGJH1033
15	3/4	ECGJH215	24	2	ECGJH624	36	1/2	ECGJH136
15	1	ECGJH315	24	2 1/2	ECGJH724	36	3/4	ECGJH236
15	1 1/4	ECGJH415	24	3	ECGJH824	36	1	ECGJH336
15	1 1/2	ECGJH515	24	4	ECGJH1024	36	1 1/4	ECGJH436
15	2	ECGJH615	27	1/2	ECGJH127	36	1 1/2	ECGJH536
15	2 1/2	ECGJH715	27	3/4	ECGJH227	36	2	ECGJH636
15	3	ECGJH815	27	1	ECGJH327	36	2 1/2	ECGJH736
15	4	ECGJH1015	27	1 1/4	ECGJH427	36	3	ECGJH836
18	1/2	ECGJH118	27	1 1/2	ECGJH527	36	4	ECGJH1036
18	3/4	ECGJH218	27	2	ECGJH627			

Dimensions In Inches:

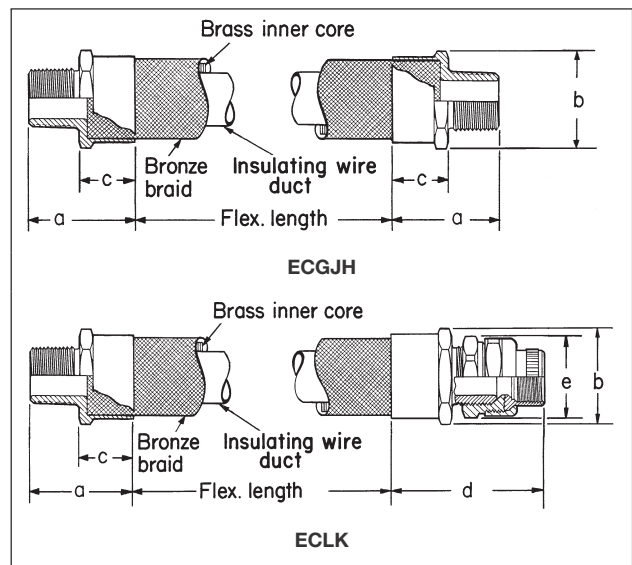

Crouse-Hinds

by **E.T.N**

5F

5F

Couplings

Cl. I, Groups A, B, C, D
Cl. II, Groups E, F, G
Cl. III

Explosionproof
Dust-Ignitionproof
Wet Locations

1/2"-2" Brass Construction
2-1/2-4" Stainless Steel construction only

5F



ECLK (ECGJH provide with UNF Female union – male connection 1 end, female connection 1 end)

Flexible Length (In.)	Size	Cat. #	Flexible Length (In.)	Size	Cat. #	Flexible Length (In.)	Size	Cat. #
4	1/2	ECLK14	18	1	ECLK318	27	2 1/2	ECLK727
4	3/4	ECLK24	18	1 1/4	ECLK418	27	3	ECLK827
6	1/2	ECLK16	18	1 1/2	ECLK518	27	4	ECLK1027
6	3/4	ECLK26	18	2	ECLK618	30	1/2	ECLK130
6	1	ECLK36	18	2 1/2	ECLK718	30	3/4	ECLK230
8	1/2	ECLK18	18	3	ECLK818	30	1	ECLK330
8	3/4	ECLK28	18	4	ECLK1018	30	1 1/4	ECLK430
8	1	ECLK38	21	1/2	ECLK121	30	1 1/2	ECLK530
10	1/2	ECLK110	21	3/4	ECLK221	30	2	ECLK630
10	3/4	ECLK210	21	1	ECLK321	30	2 1/2	ECLK730
10	1	ECLK310	21	1 1/4	ECLK421	30	3	ECLK830
12	1/2	ECLK112	21	1 1/2	ECLK521	30	4	ECLK1030
12	3/4	ECLK212	21	2	ECLK621	33	1/2	ECLK133
12	1	ECLK312	21	2 1/2	ECLK721	33	3/4	ECLK233
12	1 1/4	ECLK412	21	3	ECLK821	33	1	ECLK333
12	1 1/2	ECLK512	21	4	ECLK1021	33	1 1/4	ECLK433
12	2	ECLK612	24	1/2	ECLK124	33	1 1/2	ECLK533
12	2 1/2	ECLK712	24	3/4	ECLK224	33	2	ECLK633
12	3	ECLK812	24	1	ECLK324	33	2 1/2	ECLK733
12	4	ECLK1012	24	1 1/4	ECLK424	33	3	ECLK833
15	1/2	ECLK115	24	1 1/2	ECLK524	33	4	ECLK1033
15	3/4	ECLK215	24	2	ECLK624	36	1/2	ECLK136
15	1	ECLK315	24	2 1/2	ECLK724	36	3/4	ECLK236
15	1 1/4	ECLK415	24	3	ECLK824	36	1	ECLK336
15	1 1/2	ECLK515	24	4	ECLK1024	36	1 1/4	ECLK436
15	2	ECLK615	27	1/2	ECLK127	36	1 1/2	ECLK536
15	2 1/2	ECLK715	27	3/4	ECLK227	36	2	ECLK636
15	3	ECLK815	27	1	ECLK327	36	2 1/2	ECLK736
15	4	ECLK1015	27	1 1/4	ECLK427	36	3	ECLK836
18	1/2	ECLK118	27	1 1/2	ECLK527	36	4	ECLK1036
18	3/4	ECLK218	27	2	ECLK627			

ECGJH and ECLK

Size	a	b	c	d	e
1/2	1 1/8	1 1/2	1 1/8	3	1 9/16
3/4	2 1/16	1 7/8	1 3/16	3 1/4	1 13/16
1	2 1/2	2 1/8	1 1/2	3 3/8	1 7/8
1 1/4	2 7/8	2 15/16	1 7/8	4 3/16	2 3/4
1 1/2	3 5/16	3 1/2	1 7/8	5 1/16	3 1/16
2	3 3/4	4 1/4	2	5 1/16	3 13/16
2 1/2	3	4 7/16	1 3/8	5 1/16	4 5/16
3	3 3/8	4 9/16	1 3/4	5 3/8	5 1/16
4	4 3/8	4 15/16	3 1/4	7 1/2	6 3/16

Minimum Recommended Radius of Bend

Size	Radius	Size	Radius
1/2	10	2	16
3/4	12	2 1/2	16
1	14	3	18
1 1/4	14	4	30
1 1/2	16		

Applications:

XD couplings can be installed indoors, outdoors, buried underground, or embedded in concrete in non-hazardous areas. XD's are used with standard rigid conduit or PVC rigid conduit. (PVC requires rigid metal conduit nipples and rigid metal-to-PVC conduit adapters.) XD's provide a flexible and watertight connection for protection of conduit wiring systems from damage due to movement.

Typical applications include:

- Underground conduit feeder runs
- Runs between sections of concrete subject to relative movement
- Runs between fixed structures
- Conduit entrances in high-rise buildings
- Bridges
- Marinas, docks, piers

Features:

- XD couplings accommodate the following movements without collapsing or fracturing the conduit, and damaging the wires it contains:
 1. Axial expansion or contraction up to 3/4"
 2. Angular misalignment of the axes of the coupled conduit runs in any direction to 30°
 3. Parallel misalignment of the axes of coupled conduit runs in any direction to 3/4"
- Inner sleeve maintains constant I.D. in any position and provides a smooth insulated wireway for protection of wire insulation
- Watertight flexible neoprene outer jacket is corrosion resistant and protects the grounding strap and the attachment points of the hubs
- Tinned copper flexible braid grounding straps assure grounding continuity
- Stainless steel jacket clamps for strength and corrosion resistance
- Standard tapered electrical threads fit standard rigid conduit
- Integral hub bushing protects insulation of conductors

Certifications and Compliances:

- UL Standard: 514B

Standard Materials:

- Hubs – *Feraloy*® iron alloy
- Outer jacket – molded neoprene
- Jacket clamps – stainless steel
- Inner sleeve – molded plastic
- Grounding straps – tinned copper flexible braid

Standard Finishes:

- *Feraloy* – electrogalvanized
- Neoprene – natural (black)
- Molded plastic – natural (brown)

Options:

Description	Suffix
Hot dipped galvanized	HDG

Size Ranges:

- 1" to 6" (Smaller sizes can be obtained by using reducing bushings)

Crouse-Hinds

by **E•T•N**

XD

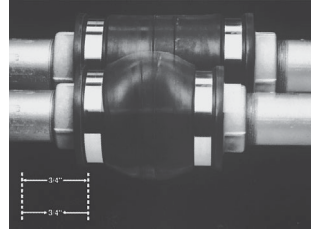

1. Axial expansion/contraction.

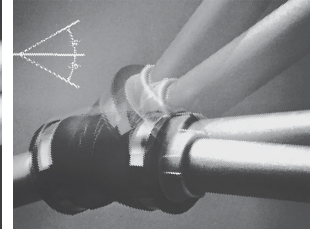

2. Angular misalignment.

Ordering Information

Hub Size	Cat. #	Hub Size	Cat. #
1	XD3	3	XD8
1 1/4	XD4	3 1/2	XD9
1 1/2	XD5	4	XD010
2	XD6	5	XD012
2 1/2	XD7	6	XD014

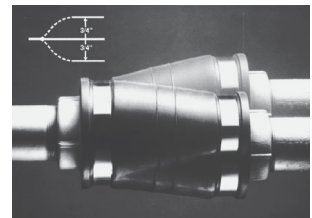

3. Parallel misalignment.

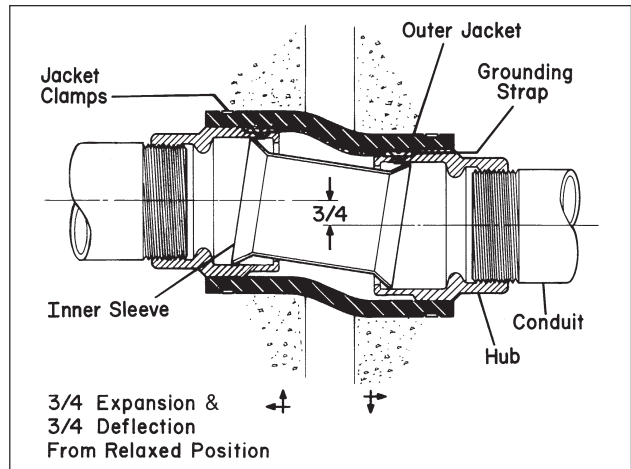

Dimensions In Inches:

Hub Size	a	b
1	7	3 15/16
1 - 1/4	7 3/8	4 1/4
1 1/2	7 1/4	4 1/2
2	7 1/4	4 15/16
2 1/2	7 1/2	5 5/16
3	7 5/8	5 15/16
3 1/2	7 3/4	6 1/2
4	7 7/8	6 15/16
5	7 3/4	8
6	8 3/8	9

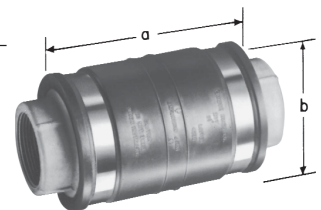

5F XJG Conduit Expansion Joints With Internal Grounding For Rigid Metal Conduit and IMC

Wet Locations

5F

Applications:

XJG expansion couplings are used with rigid metal conduit and IMC:

- Without the need for an external bonding jumper and clamps (up to 4")
- To couple together two (2) sections of conduit subject to longitudinal movement
- In long conduit runs to permit linear movement caused by thermal expansion and contraction
- On long conduit runs to prevent conduit from buckling and ensuing circuit failures
- Indoors or outdoors where conduit expansion occurs and there are wide temperature ranges
- In conduit runs that cross structural joints
- In conduit runs to prevent damage to conduit supports such as in a building or on a bridge
- With optional redundant visible grounding strap

Certifications and Compliances:

- UL Standard: 514B
- CSA Standard: C22.2 No. 18
- NEC Articles 250-77 and 300-7 (b)
- NEMA FB1
- Wet Locations

Standard Materials and Finishes:

Body

- Steel - electrogalvanized
- Copper-free aluminum - natural
- *Feraloy*[®] iron alloy - electrogalvanized (5" + 6" only)

Reducer

- 1/2" through 1" - Steel - electrogalvanized
- 1 1/4" through 6" - *Feraloy*[®] iron alloy - electrogalvanized and aluminum paint
- Copper-free aluminum - natural

Gland Nut

- 1/2" through 1" - Steel - electrogalvanized
- 1 1/4" through 6" - *Feraloy*[®] iron alloy - electrogalvanized and aluminum paint
- Copper-free aluminum - natural

Packing

- Teflon[®] (trademark of E.I. DuPont Co.)

Washer

- Steel - electrogalvanized
- Copper-free aluminum - natural

Gasket

- Vellum

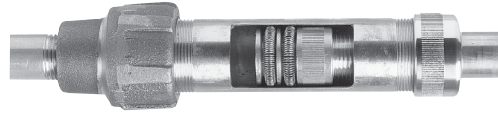

Patented Design

Ordering Information

Conduit Size	Maximum Conduit Movement	Cat. #	Optional Bonding Jumper†	A Diameter	B Length	Bonding Jumper Length
1/2	4	XJG14	BJ14	1.75	6.75	20"
	8	XJG18	BJ18	1.75	10.75	30"
3/4	4	XJG24	BJ24	2.12	6.75	20"
	8	XJG28	BJ28	2.12	10.75	30"
1	4	XJG34	BJ34	2.43	7.25	20"
	8	XJG38	BJ38	2.43	11.25	30"
1 1/4	4	XJG44	BJ44	3.19	7.56	24"
	8	XJG48	BJ48	3.19	11.56	30"
1 1/2	4	XJG54	BJ54	3.68	7.87	24"
	8	XJG58	BJ58	3.68	11.87	30"
2	4	XJG64	BJ64	4.75	8.25	24"
	8	XJG68	BJ68	4.75	12.25	30"
2 1/2	4	XJG74	BJ74	4.87	9.31	24"
	8	XJG78	BJ78	4.87	13.31	36"
3	4	XJG84	BJ84	5.37	10.00	30"
	8	XJG88	BJ88	5.37	14.00	36"
3 1/2	4	XJG94	BJ94	6.62	9.81	30"
	8	XJG98	BJ98	6.62	13.81	36"
4	4	XJG104	BJ104	6.62	9.81	30"
	8	XJG108	BJ108	6.62	13.81	36"
5	8	XJ128‡	—	7.64	15.50	—
6	8	XJ148‡	—	9.56	16.00	—

†XJG expansion couplings use a metallic bushing and ground springs to create a high integrity internal ground connection. External ground straps offer a redundant ground path and easy visible indication of ground.

‡XJ128 and XJ148 are not internally grounded. A pair of 36" bonding jumpers are provided with fitting.

Bushing

- 1/2" through 1" - Steel - electrogalvanized
- 1 1/4" through 6" - *Feraloy*[®] iron alloy - electrogalvanized and aluminum paint
- Copper-free aluminum - natural

Ground Springs

- Phosphor bronze - electrogalvanized

Ground Strap

- Braided tinned copper

U-Bolts

- Malleable iron - electrogalvanized

Options:

Description

Available in copper-free aluminum
Not available on 5" and 6" sizes

Hot dipped galvanized

Available with redundant† ground strap for visible indication of grounding – order separately (BJ Series)

Size Ranges:

- 1/2" through 6" conduit size
- 4" and 8" maximum conduit movement

Dimensions In Inches:

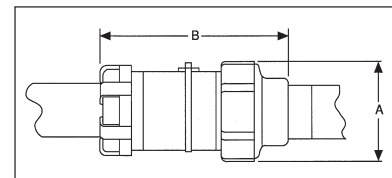

XJG shown with optional bonding jumper

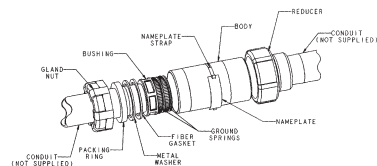

Crouse-Hinds
by **E.T.N**

XJG-EMT Conduit Expansion Joints With Internal Grounding For EMT Conduit



Applications:

- XJG expansion couplings are used with EMT Conduit:
- Without the need for an external bonding jumper and clamps
 - To couple together two (2) sections of conduit subject to longitudinal movement
 - In long conduit runs to permit linear movement caused by thermal expansion and contraction
 - On long conduit runs to prevent conduit from buckling and ensuing circuit failures
 - Indoors or outdoors where conduit expansion occurs and there are wide temperature ranges
 - In conduit runs that cross structural joints
 - In conduit runs to prevent damage to conduit supports such as in a building or on a bridge
 - With optional redundant visible grounding strap

Certifications and Compliances:

- UL Standard: 514B
- CSA Standard: C22.2 No. 18
- NEC Articles 250-77 and 300-7 (b)
- NEMA FB1

Standard Materials and Finishes:

Body

- Steel - electrogalvanized
- Copper-free aluminum - natural

Reducer

- 1/2" through 1" - Steel - electrogalvanized
- 1 1/4" through 4" - *Feraloy*® iron alloy - electrogalvanized and aluminum paint

Gland Nut

- 1/2" through 1" - Steel - electrogalvanized
- 1 1/4" through 4" - *Feraloy*® iron alloy - electrogalvanized and aluminum paint

Packing

- Teflon® (trademark of E.I. DuPont Co.)

Washer

- Steel - electrogalvanized

Gasket

- Vellum

Bushing

- 1/2" through 1" - Steel - electrogalvanized
- 1 1/4" through 4" - *Feraloy*® iron alloy - electrogalvanized and aluminum paint

Ground Springs

- Phosphor bronze - electrogalvanized

Ground Strap

- Braided tinned copper

U-Bolts

- Malleable iron – electrogalvanized

Crouse-Hinds

by **E.T.N**

Options:

Available with redundant† ground strap for visible indication of grounding – order separately (BJ Series)

Size Ranges:

- 1/2" through 4" conduit size
- 4" maximum conduit movement

Ordering Information

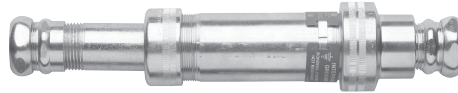

Conduit Size	Maximum Conduit Movement	Cat. #	Optional Bonding Jumper	A Diameter	B Length
1/2"	4"	XJG14 EMT	BJ14	1 3/4"	10 3/4"
3/4"	4"	XJG24 EMT	BJ24	2 1/8"	11"
1"	4"	XJG34 EMT	BJ34	2 7/16"	11 1/2"
1 1/4"	4"	XJG44 EMT	BJ44	3 3/8"	15 1/4"
1 1/2"	4"	XJG54 EMT	BJ54	3 5/8"	15 1/2"
2"	4"	XJG64 EMT	BJ64	4 3/4"	15 1/2"
2 1/2"	4"	XJG74 EMT	BJ74	4 7/8"	18 3/4"
3"	4"	XJG84 EMT	BJ84	5 3/8"	19 7/8"
3 1/2"	4"	XJG94 EMT	BJ94	6 3/8"	21 1/4"
4"	4"	XJG104 EMT	BJ104	6 5/8"	21 1/4"



XJG shown with optional bonding jumper

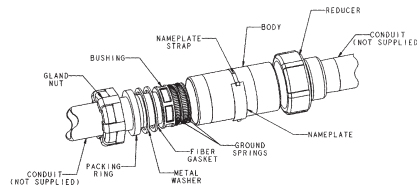

†XJG expansion couplings use a metallic bushing and ground springs to create a high integrity internal ground connection. External ground straps offer a redundant ground path and easy visible indication of ground.

XJGD Combination Expansion/Deflection Coupling and Expansion Joint Internally Grounded

Applications:

XJGD combination fittings are used with rigid metal conduit and IMC:

- To accommodate axial expansion, angular misalignment and parallel misalignment
- To couple together two (2) sections of conduit subject to longitudinal movement
- To maintain a ground connection without the need for an external bonding jumper and clamps
- In long conduit runs to prevent conduit from buckling and causing circuit failures
- Indoors or outdoors where conduit expansion occurs and there are wide temperature swings
- In conduit runs that cross structural joints
- In conduit runs to prevent damage to conduit supports such as in a building or on a bridge

Certifications and Compliances:

- UL Standard: 514B

Standard Materials:

- Body, Hubs, Gland Nut, Washer, Bushing – *Feraloy*[®]
- Packing – Teflon[®]
- Gasket – vellum
- Ground Spring – phosphor bronze
- Outer Jacket – molded neoprene
- Jacket Clamps – stainless steel
- Inner Sleeve – molded plastic
- Ground Straps – tinned copper braid

Standard Finishes:

- *Feraloy*[®] – electrogalvanized

Ordering Information



Hub Size	Maximum Conduit Movement	Cat. #	A Diameter	B Length
1"	4"	XJGD34	3 ¹⁵ / ₁₆ "	17 ³ / ₄ "
1 ¹ / ₄ "	4"	XJGD44	4 ¹ / ₄ "	18 ¹ / ₈ "
1 ¹ / ₂ "	4"	XJGD54	4 ¹ / ₂ "	18 ⁵ / ₈ "
2"	4"	XJGD64	4 ¹⁵ / ₁₆ "	19 ¹ / ₄ "
2 ¹ / ₂ "	4"	XJGD74	5 ³ / ₁₆ "	20 ³ / ₄ "
3"	4"	XJGD84	5 ¹⁵ / ₁₆ "	21 ⁵ / ₈ "
3 ¹ / ₂ "	4"	XJGD94	6 ¹ / ₂ "	21 ¹ / ₈ "
4"	4"	XJGD104	8"	27 ³ / ₄ "

(Also see Myers Hubs see page 211)

Applications:

HUB Conduit Hubs:

- Provide a convenient means for installing a threaded conduit hub on a junction box or device enclosure
- Are used to connect conduit to a sheet metal or cast enclosure
- Are used with threaded rigid conduit or IMC, steel or aluminum; indoors or outdoors

Features:

- Smooth insulated throat provides easier wire pulling and protection for conductors during installation.
- Neoprene sealing gasket provides a watertight seal.
- Compact design permits close spacing of conduit.
- Wide range of sizes from 1/2" to 4".

Certifications and Compliances:

- UL Standard: 514B
- CSA Standard: C22.2 No. 18
- NEC/CEC:
 - Class I, Division 2, Groups A, B, C, D
 - Per NEC 501-4(b), 502-4(a) and 503-3(a)

Standard Materials:

- 1/2" to 4" malleable iron

Standard Finishes:

- *Feraloy* iron alloy – electrogalvanized and aluminum acrylic paint

Size Ranges:

- 1/2" to 4"

Ordering Information

Conduit Size	Cat. #
1/2	HUB1
3/4	HUB2
1	HUB3
1 1/4	HUB4
1 1/2	HUB5
2	HUB6
2 1/2	HUB7
3	HUB8
3 1/2	HUB9
4	HUB10

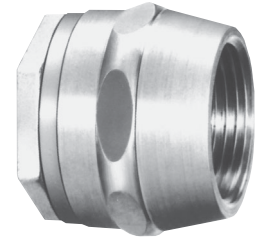

Dimensions In Inches:

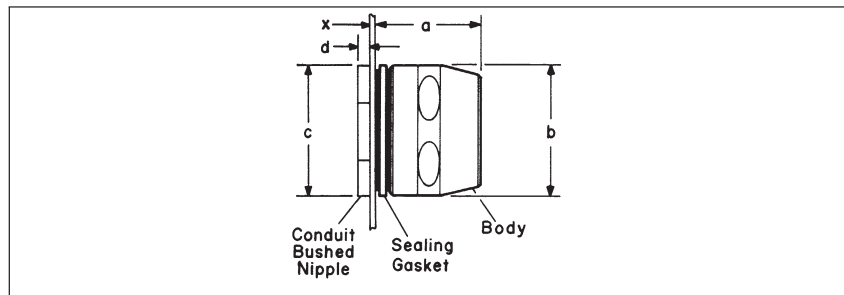

Cat. #	Conduit Size	a	b	c	d	x
HUB1	1/2	1	1 1/4	1	1/8	9/64
HUB2	3/4	1 1/8	1 9/16	1 3/8	5/32	1/4
HUB3	1	1 3/8	1 7/8	1 5/8	3/16	9/32
HUB4	1 1/4	1 1/2	2 5/16	2	1/4	7/16
HUB5	1 1/2	1 5/8	2 1/2	2 3/8	1/4	7/16
HUB6	2	1 11/16	3	2 13/16	1/4	7/16
HUB7	2 1/2	2 3/16	3 5/8	3 7/16	1/4	7/16
HUB8	3	2 7/16	4 1/4	4 1/16	1/4	7/16
HUB9	3 1/2	2 7/16	4 3/4	4 11/16	5/16	3/4
HUB10	4	2 9/16	5 1/4	5 1/16	5/16	1 1/8

Dimension "x" is maximum wall thickness of box that will meet the requirement for three full threads engagement of nipple and fitting body when liquidtight box connector or rigid conduit hub is installed in a knockout or slip hole.

5F Grounding Devices Straps and Clamps

5F

Applications:

- GCR grounding receptacles are used to provide static electricity grounding connections; particularly suited for, but not limited to, use in aircraft hangar floors and airport aprons.
- GCT ground connector and studs are used to provide "quick-connect" static electricity grounding connections with portable cable.
- GC grounding strap and clamp are suitable for bonding and grounding equipment in wiring systems, such as meter circuits, service entrance equipment, and appliances per NEC requirements.

Features:

GCR grounding receptacles have:

- Grounding stud integral with housing
- Grounding stud designed to accept standard battery clip
- Thread at bottom for attaching to 3/4" threaded grounding rod
- Cover attached to receptacle by chain to prevent loss of cover
- Corrosion resistant material

GCT grounding connector and studs have:

- Substantial clip tension for grounding
- Integral cable clamp to prevent cable from breaking free of connector or fraying at connector
- Lock washer on stud to maintain good electrical contact

GC strap:

- Is pliable, strong and corrosion resistant
- Assures a lasting bond. Prongs on strap clamp engage strap perforations, preventing slippage.

Certifications and Compliances:

- UL Standard: GC strap and clamps – 467
- CSA Standard: C22.2 No. 41

Standard Materials:

- GCR – Bronze body, cap and chain; brass grounding stud
- GCT – Bronze connector body; aluminum cable clamp; brass stud
- Strap – flexible copper
- Clamp – brass

Standard Finishes:

- Bronze, brass, aluminum parts – natural
- Flexible copper strap – tinned

GCT Grounding Connector



Cable Dia.	Cat. #
.312" to .406"	GCT8

GCT Stud*

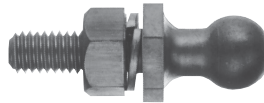

Description	Thread Size	Cat. #
Brass	3/8 - 16	GCT2

*Not a replacement for grounding stud in GCR receptacle.

GC Grounding Strap

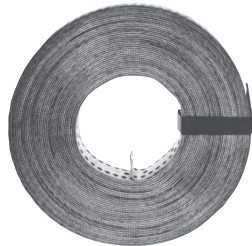

Used with GC102 Strap Clamp

Description	Cat. #
50' coil, 1" wide	GC100

GCR Receptacles For Static Electricity Grounding



Description	Thread Size	Cat. #
With cap and chain	5/16 - 18	GCR210

Strap Clamp

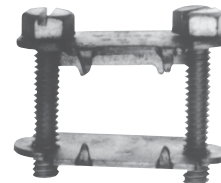

Description	Cat. #
Brass	GC102

Dimensions In Inches:

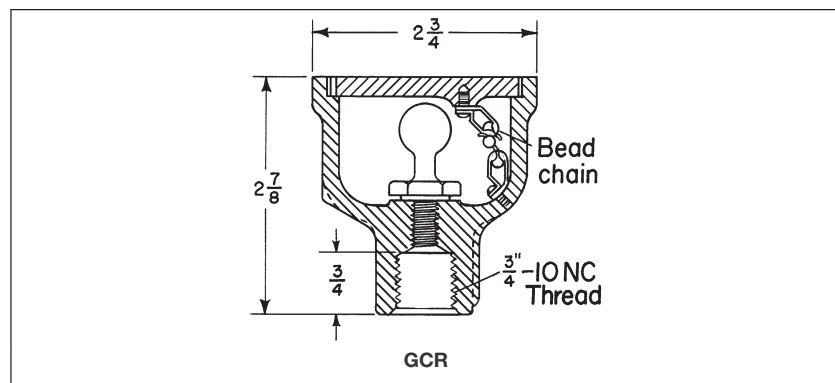

Service Entrance Heads and Replacement Covers

5F

5F

Applications:

- F type service entrance heads are used:
- For overhead service entrance to buildings
 - With threaded rigid, threadless rigid or threadless thinwall (EMT) conduit and rigid conduit masts

Features:

- Two types available:
- Threaded rigid – threads to conduit.
 - Threadless rigid or EMT – clamps to conduit.
 - Available knockouts in covers allow use with variety of sizes and numbers of wires.
 - Simple construction and easy assembly.
 - Consists of only two pieces plus the insulating knockout cover.
 - Easy to install.

Certifications and Compliances:

- UL Standard: 514B
- CSA Standard: C22.2 No. 18

Standard Materials:

- Copper-free aluminum

Standard Finishes:

- Natural

F Service Heads Threaded Rigid



1/2" size



3/4" - 2" size



1/2" size

Conduit Size	Number and Dia. of Cover Knockouts	Cat. #	Replacement Cover Cat. #
1/2	6 - 9/32	F186	CF690
3/4	2 - 3/8 and 3 - 13/32	F285	5 H
1	2 - 7/16 and 3 - 1/2	F385	5 NS
1 1/4	2 - 27/64 and 3 - 5/8	F485	5 NL
1 1/2	2 - 27/64 and 3 - 5/8	F585	5 NL
2	2 - 7/8, 1 - 13/16, 1 - 11/16, 1 - 9/16 and 1 - 21/32	F686	CF60
2 1/2	2 - 17/16, 1 - 17/32, 1 - 1 1/64, 1 - 61/64 and 1 - 55/64	F766	CF707
3	2 - 1 1/16, 1 - 1 1/32, 1 - 1 1/64, 1 - 61/64 and 1 - 55/64	F866	CF707
3 1/2	3 - 1 3/4, 1 - 1 7/16, 1 - 1 5/16 and 1 - 1 3/16	F966	CF708
4	3 - 1 3/4, 1 - 1 7/16, 1 - 1 5/16 and 1 - 1 3/16	F1066	CF708

Overall Dimensions of Replacement Covers for F Series Service Heads

Cat. #	Dim.
CF690	1 1/2 dia.
5 H	1 31/32 dia.
5 NS	2 15/64 dia.
5 NL	2 19/32 dia.
CF60	3 3/16 dia.
CF707	7 13/16 x 3 11/16
CF708	10 1/4 x 4 3/4

Clamp Type Threadless Rigid or EMT



Conduit Size	Number and Dia. of Cover Knockouts	Cat. #	Replacement Cover Cat. #
3/4	2 - 3/8 and 3 - 13/32	F235	5 H
1	2 - 7/16 and 3 - 1/2	F335	5 NS
1 1/4	2 - 27/64 and 3 - 5/8	F435	5 NL
1 1/2	2 - 27/64 and 3 - 5/8	F535	5 NL
2	2 - 7/8, 1 - 13/16, 1 - 11/16, 1 - 9/16 and 1 - 21/32	F636	CF60

5F LNR Conduit Liner

5F

Applications:

- LNR conduit liners are installed in rigid metal conduit or IMC:
- To provide a smooth wire entry from conduit into enclosures to protect wires from abrasion as they are pulled.
 - With thin wall or thick wall enclosures.
 - Entering drilled and tapped openings or slip holes.
 - Entering an enclosure vertically or horizontally.
 - Regardless of where the conduit ends in relation to the enclosure wall.

Features:

- UL listed and CSA certified.
- No need for threaded bushings, reducers, or special machining.
- Corrosion and heat resistant polypropylene material.
- Smooth flange providing easy wire pulling and protects conductors being installed.
- Space saving.
- Molded ribs ensure a tight fit, preventing the liner from sliding out while conductors are being pulled.
- Quick and easy to install.

Certifications and Compliances:

- NEC Article 346-8
- UL Standard 514B
- CSA Standard C22.2 No. 18
- U.S. Patent No. 5,383,688

Standard Materials:

- Polypropylene

Standard Finishes:

- Natural (clear)

Sizes:

- 1/2" through 4"

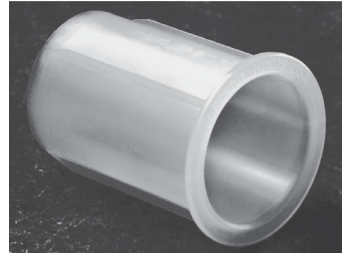

Ordering Information

Cat. #	Size	A	B	C	D
LNR1	1/2"	1 3/16"	7/8"	5/8"	9/16"
LNR2	3/4"	1 9/16"	1 1/8"	13/16"	3/4"
LNR3	1"	2 1/16"	1 3/8"	1 1/16"	7/8"
LNR4	1 1/4"	2 7/16"	1 3/4"	1 3/8"	1 1/4"
LNR5	1 1/2"	2 9/16"	2"	1 5/8"	1 7/16"
LNR6	2"	2 9/16"	2 7/16"	2 1/16"	1 7/8"
LNR7	2 1/2"	2 7/8"	2 7/16"	2 1/4"	
LNR8	3"	2 7/8"	3 9/16"	3 1/16"	2 7/8"
LNR9	3 1/2"	3 1/16"	4 1/16"	3 9/16"	3 3/8"
LNR10	4"	3 1/16"	4 9/16"	4"	3 7/8"

Dimensions In Inches:

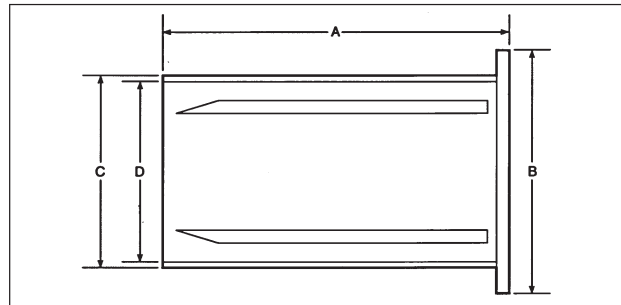



Description	Page No.
Application/Selection	see page 138
Breathers & Drains	
Standard	
ECD Series	see page 158
CD Series (Non-hazardous)	see page 159
Universal	
ECD Series	see page 158
Sealing Compound	
Chico® A	see pages 155–156
Chico® SpeedSeal™	see pages 155–156
Sealing Fiber	
Chico® X	see pages 155–156
Sealing Fittings Tool Kit	
EYS Tool Kit	see page 157
Seals	
Drains	
EYD Series	see page 144
EZD Series	see page 145
EYDX Series	see page 147
Elbows	
EYS	see page 140
Horizontal/Vertical	
ES Series	see page 149
EYS Series	see page 140
EYS Series with ATEX	see page 142
EYSA Series	see page 143
EYSX Series	see page 146
Inspection	
EZD Series	see page 145
Retrofit	
EYSR Series	see page 148
Universal	
EZS Series	see page 141
EZS Series with ATEX	see page 142
Secondary Process Seals	
Ultra High Pressure Seal	see page 150
Secondary Process Seal Assembly with Rupture Sensor	see pages 151–154

6F Conduit Seals, Breathers and Drains

Application and Selection

6F

Applications:

Seals:

- Seals are installed in conduit runs to prevent the passage of gases, vapors or flames from one portion of the electrical installation to another through the conduit, limiting any explosion to the enclosure and preventing precompression or "pressure piling."
- While not a National Electrical Code requirement, many engineers consider it good practice to sectionalize long conduit runs by inserting seals not more than 50' to 100' apart, depending on the conduit size, to minimize the effects of "pressure piling."

Breathers:

- Breathers (vents), are installed in the top of enclosures to provide ventilation to minimize condensation in enclosures.

Drains:

- Drains are used in humid atmospheres or in wet locations where it is likely that water can gain entrance to the interiors of enclosures or raceways. The raceways should be inclined so that water will not collect in enclosures or on seals, but will be led to low points where it may pass out through ECD drains.
- Frequently the arrangement of raceway runs makes this method impractical if not impossible. In such instances, EZD or EYD drain seal fittings should be used. These fittings prevent harmful accumulations of water above the seal.

Considerations for Selection:

Seals:

- Select the proper sealing fitting for the hazardous vapor involved; i.e., Class I, Division 1 & 2, Groups A, B, C or D.
- Select the appropriate seal for new or retrofit installations.
- Select a sealing fitting for the proper use in respect to mounting position. This is particularly critical when the conduit runs between hazardous and non-hazardous areas. Improper positioning of a seal may permit hazardous gases or vapors to enter the system beyond the seal and permit them to escape into another portion of the hazardous area or to enter a non-hazardous area. Some seals are designed to be mounted in any position; others are restricted to vertical mounting.

The amount of *Chico*® fiber and compound required for any seal is determined by volume, hub size and mounting position of the seal.

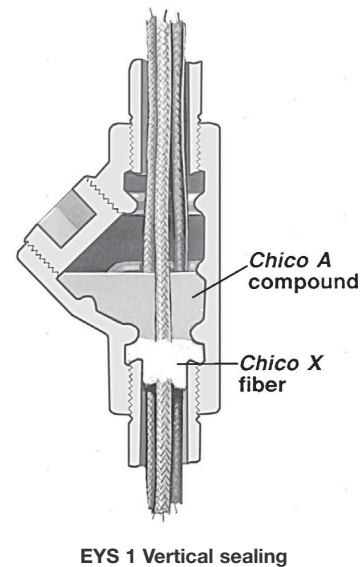
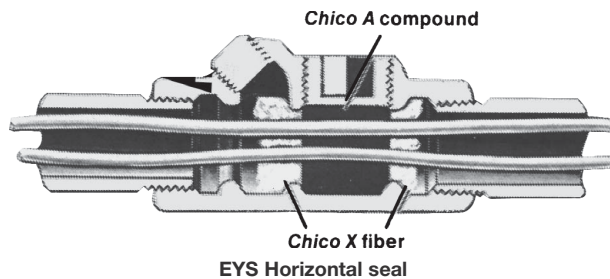
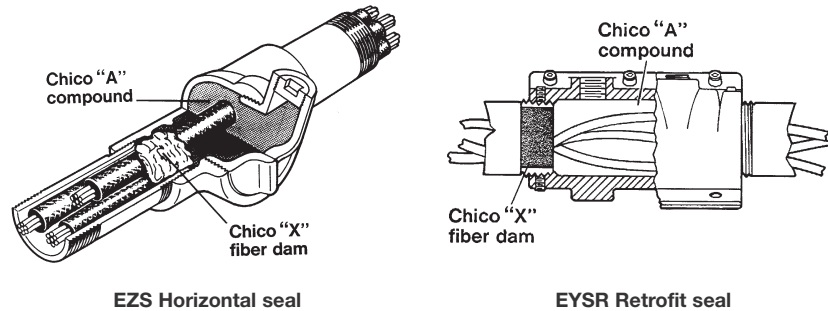







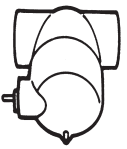
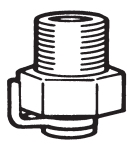

Drains:

- In locations which are usually considered dry, surprising amounts of water frequently collect in conduit systems. No conduit system is airtight, therefore, it may "breathe". Alternate increases and decreases in temperature and/or in barometric pressure, due to weather changes or due to the nature of the process carried on in the location where the conduit is installed, will cause "breathing," resulting in condensation and water accumulation.
- In view of this likelihood, it is therefore good practice to insure against such water accumulations and probable subsequent insulation failures by installing breathers, drain seals, or inspection seals, even though conditions prevailing at the time of planning or installing do not indicate their need.

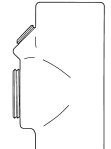
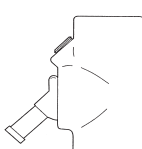
Options:

Description	Suffix
Corro-free™ epoxy powder coat	S752

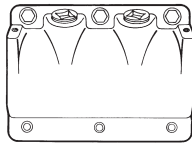
Shape Selector Chart Quick Selector Chart

Series	Page	Series	Page	Series	Page	Series	Page	Series	Page
EYS / EYSA	see page 140	EZD	see page 145	ECD Standard	see page 158	ECD Universal	see page 158	EYSX	see page 146
									
EYS Elbow Seal	see page 140	ES	see page 149			EYD	see page 144	EYSR	see page 144
									

Quick Selector Chart

Series	Description	NEC Hazardous Group	For Conduit Angle
EYS	Seal	Class I, Groups A, B, C, D Class II, Groups E, F, G	Vertical and Horizontal
EYS ATEX	Seal	Ex II 2 G EEx d IIC	Vertical and Horizontal
EYSA	Seal	Flameproof, Exd, IIC	Vertical and Horizontal
EYS 29	Elbow Seal	Class I, Groups C, D Class II, Groups E, F, G	90° turn
EYSR	Retrofit Seal/Drain Seal*	Class I, Div. 2, Groups C, D Class II, Div. 2, Groups E, F, G Class III	Vertical and Horizontal
EYSX	Expanded Fill Sealing Fittings	Class I, Groups B, C, D Class II, Groups E, F, G	Vertical and Horizontal
EZS	Seal	Class I, Groups C, D Class II, Groups E, F, G	All
EZS ATEX	Seal	Ex II 2 G EEx d IIC	All
ES	Sealing Hub	Class I, Groups C, D	Vertical
EYD	Seal and Drain	Class I, Groups B, C, D Class II, Groups F, G	Vertical
EYDX	Expanded Fill Sealing Fittings and Drain	Class I, Groups B, C, D Class II, Groups F, G	Vertical
EZD	Inspection Seal and Drain – Inspection Seal only	Class I, Groups C, D Class II, Groups E, F, G	Vertical
ECD	Standard Breather only Drain only	Class I, Groups B, C, D Class II, Groups E, F, G Class III	
ECD	Universal Drain – Breather	Class I, Groups C, D Class II, Groups F, G	
CD	Non-hazardous Drain		
UHPS	Ultra High Pressure Seal	Class I, Div. 1, Groups B, C, D Certified to CSA Standards through QPS	
SPSR	Secondary Process Seal with Rupture Sensor	Class I, Div. 1 & 2, Groups B, C, D Class I, Zone 1 & 2 IIB + H ₂ Class II, Div. 1 & 2, Groups E, F, G	

*Drain purchased separately.



Conduit Sealing Fittings

Chico Sealing Compound and Fiber see pages 155-156

Cl. I, Div. 1 & 2, Groups A, B, C, D Explosionproof
 Cl. II, Div. 1, Groups E, F, G Dust-Ignitionproof
 Cl. II, Div. 2, Groups F, G
 Cl. III

6F

Applications:

- EYS and EZS sealing fittings:
- Restrict the passage of gases, vapors or flames from one portion of the electrical installation to another at atmospheric pressure and normal ambient temperatures
 - Limit explosions to the sealed off enclosure
 - Limit precompression or pressure "piling" in conduit systems
- Sealing fittings are required:
- At each entrance to an enclosure housing an arcing or sparking device when used in Class I, Division 1 and 2 hazardous locations. To be located as close as practicable and, in no case, more than 18" from such enclosures
 - At each conduit entrance of 2" size or larger to an enclosure or fitting housing terminals, splices or taps when used in Class I, Division 1 hazardous locations. To be located as close as practicable and, in no case, more than 18" from such enclosures
 - In conduit systems when leaving Class I, Division 1 or Division 2 hazardous locations
 - In cable systems when the cables either do not have a gas/vaportight continuous sheath or are capable of transmitting gases or vapors through the cable core when those cables leave the Class I, Division 1 or Division 2 hazardous locations

Features:

- EYS and EZS sealing fittings include:
- Minimum turning radius
 - Large openings with threaded closures to provide easy access to conduit hubs for making dams
 - Integral bushings in conduit hubs to protect conductor insulation from damage
 - Taper-tapped hubs to ensure ground continuity
- EYS sealing fittings are available for installation in either vertical only or in both horizontal or vertical positions.
- EZS sealing fittings for installation at any angle; the covers with opening for sealing compound can be properly positioned to accept the compound.

Certifications and Compliances:

- NEC/CEC:
 - EYS1-3, 11-31, 16-36, 116-316**
Class I, Division 1 & 2, Groups A, B, C, D
Class II, Division 1, Groups E, F, G
Class II, Division 2, Groups F, G
Class III
 - EYS41-101, 416-1016**
Class I, Division 1 & 2, Groups B, C, D
Class II, Division 1, Groups E, F, G
Class II, Division 2, Groups F, G
Class III
 - EYS29, 4-014, 46-0146**
EZS1-8, 16-86
Class I, Division 1 & 2, Groups C, D
Class II, Division 1, Groups F, G
Class II, Division 2, Groups F, G
Class III
- UL Standard: 1203
- CSA Standard: C22.2

Sealing fittings are approved for use in hazardous locations only when *Chico*® X fiber and *Chico A* sealing compound or Chico SpeedSeal are used to make the seal.

Standard Materials:

- Bodies – *Feraloy*® iron alloy and/or ductile iron
- Plugs – *Feraloy* iron alloy and/or steel
- Removable nipples – steel

Standard Finishes:

- Feraloy* iron alloy and ductile iron – electrogalvanized and aluminum acrylic paint
- Steel – electrogalvanized

Options:

Description
Copper-free aluminum bodies, nipples and enclosures

Suffix
SA

Size Ranges:

- 1/2" – 6"

Ordering Information - EYS

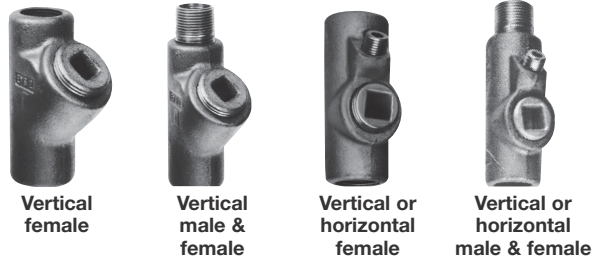

For Sealing in Vertical Positions Only

Hub Size	Female Hub Cat. #	Male & Female Hub Cat. #	Approximate Internal Volume in Cubic Inches
1/2	EYS1*	EYS16*	1
3/4	EYS2*	EYS26*	2
1	EYS3*	EYS36*	3 3/4

For Sealing in Vertical or Horizontal Positions

Hub Size	Female Hub Cat. #	Male & Female Hub Cat. #	Approximate Internal Volume in Cubic Inches	
			Vertical	Horizontal
1/2	EYS11*	EYS116*	1	1
3/4	EYS21*	EYS216*	2	2
1	EYS31*	EYS316*	3	3 3/4
1 1/4	EYS41	EYS416	6	8
1 1/2	EYS51	EYS516	10 3/4	12 1/4
2	EYS61	EYS616	19	22 3/4
2 1/2	EYS71	EYS716	25 1/2	30
3	EYS81	EYS816	56	64 1/2
3 1/2	EYS91	EYS916	72	82
4	EYS101	EYS1016	95	110

*Available in copper-free aluminum – to order, add suffix SA to Cat. No.

Dimensions (In Inches)

EYS 16 Series				EYS 116 Series		
Size	a	b	Turning Radius	a	b	Turning Radius
1/2	3 9/32	1 1/4	1 5/8	3 11/16	1 1/4	1 3/32
3/4	3 12/16	1 1/2	1 29/32	3 11/16	1 1/2	1 1/4
1	4 5/16	1 3/4	2 3/8	4 5/16	1 3/4	1 5/8

EYS 46 Series				EYS 116 Series		
Size	a	b	Turning Radius	a	b	Turning Radius
1 1/4	5 1/16	2 3/16	1 23/32	5 1/16	2 3/16	1 23/32
1 1/2	5 1/2	2 7/16	2 1/16	5 1/2	2 7/16	2 1/16
2	6 1/4	3	2 5/16	6 1/4	3	2 5/16
2 1/2	7 1/2	3 1/2	2 11/16	7 1/2	3 1/2	2 11/16
3	8 1/2	4 1/4	3 5/16	8 1/2	4 1/4	3 5/16
3 1/2	9 3/16	4 3/4	3 7/16 ‡	9 3/16	4 3/4	3 7/16 ‡
4	9 3/4	5 1/4	3 11/16 ‡	9 3/4	5 1/4	3 11/16 ‡
5	11 1/16	6 1/2	4 19/32 ‡			
6	12 1/8	7 5/8	5 11/32 ‡			

‡With cover removed.

Crouse-Hinds
by **E.T.N**

Conduit Sealing Fittings

Chico Sealing Compound and Fiber see pages 155-156

Cl. I, Div. 1 & 2, Groups C, D
Cl. II, Div. 1, Groups E, F, G
Cl. II, Div. 2, Groups F, G
Cl. III

Explosionproof
Dust-Ignitionproof

6F

Ordering Information - EYS

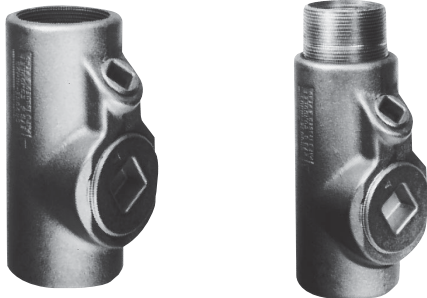

Vertical or horizontal male & female

Ordering Information - EZS

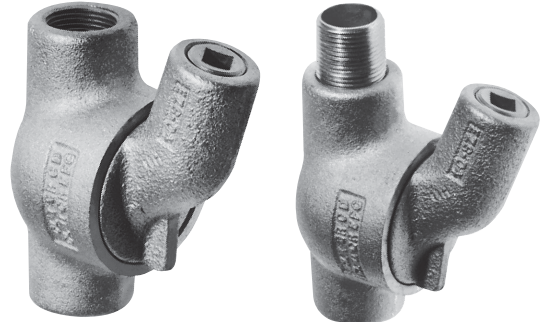

Male & female hub

For Sealing in Vertical or Horizontal Positions

Hub Size	Female Hub Cat. #	Male & Female Hub Cat. #	Approximate Internal Volume in Cubic Inches	
			Vert.	Horiz.
1¼	EYS4*	EYS46*	6	8
1½	EYS5*	EYS56*	10¾	12¼
2	EYS6*	EYS66*	19	22¾
2½	EYS7*	EYS76*	25½	30
3	EYS8*	EYS86*	56	64½
3½	EYS9*	EYS96*	72	82
4	EYS10*	EYS106*	95	110
5	EYS012	EYS0126	200	222
6	EYS014	EYS0146	290	315

*Available in copper-free aluminum – to order, add suffix SA to Cat. No.

For Sealing at Any Angle

Hub Size	Female Hub Cat. #	Male & Female Hub Cat. #	Approximate Internal Volume in Cubic Inches	
			Vert.	Horiz.
½	EZS1	EZS16	6¼	6¼
¾	EZS2	EZS26	6½	6½
1	EZS3	EZS36	10¼	10¼
1¼	EZS4	EZS46	12½	12½
1½	EZS5	EZS56	14½	14½
2	EZS6	EZS66	46	46
2½	EZS7	EZS76	55	55
3	EZS8	EZS86	90	90

EYS



Elbow seal

For Sealing in Vertical Positions

Hub Size	Cat. #	Approximate Internal Volume in Cubic Inches
¾	EYS29	1¾

Dimensions In Inches

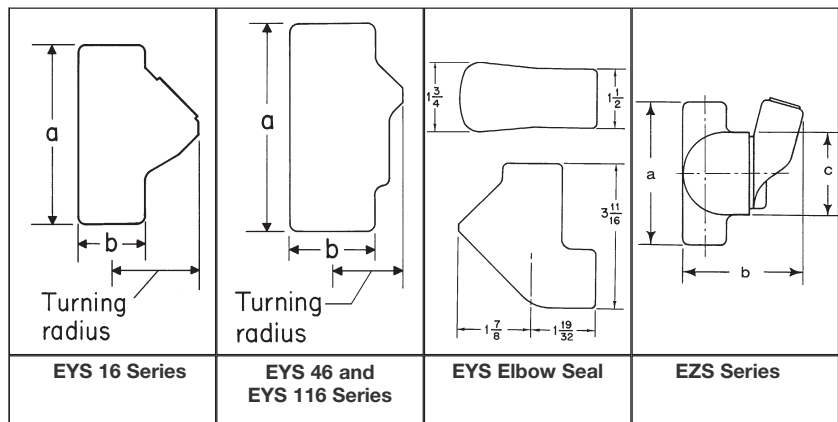

EYS Elbow Seal

Size	a	b	Turning Radius (Vertical)
¾	3 ¹¹ / ₁₆	1¾	1 ⁷ / ₈

EZS Series

Size	a	b	c	Turning Radius†
½	4 ⁹ / ₁₆	3 ⁵ / ₈	2½	1 ⁷ / ₈
¾	4 ³ / ₁₆	3 ⁵ / ₈	2½	1 ⁷ / ₈
1	4 ¹⁵ / ₁₆	3 ³¹ / ₃₂	3	2 ¹ / ₈
1¼	5 ¹ / ₁₆	4 ¹³ / ₃₂	3	2 ⁹ / ₁₆
1½	5 ³ / ₁₆	4 ⁹ / ₁₆	3¼	2 ¹¹ / ₃₂
2	7 ¹ / ₁₆	5 ¹³ / ₃₂	5 ³ / ₁₆	3 ³ / ₃₂
2½	7 ¹⁵ / ₁₆	5 ²⁷ / ₃₂	5 ⁹ / ₁₆	3 ³ / ₈
3	8 ⁵ / ₈	6½	5 ⁷ / ₈	3 ⁷ / ₈

†With cover removed.

for IEC Applications

6F

Applications:

EYS and EZS sealing fittings:

- Restrict the passage of gases, vapors or flames from one portion of the electrical installation to another at atmospheric pressure and normal ambient temperatures
- Limit explosions to the sealed off enclosure
- Limit precompression or pressure "piling" in conduit systems

Sealing fittings are required:

- At each entrance to an enclosure housing an arcing or sparking device when used in Class I, Division 1 and 2 hazardous locations. To be located as close as practicable and, in no case, more than 18" from such enclosures
- At each conduit entrance of 2" size or larger to an enclosure or fitting housing terminals, splices or taps when used in Class I, Division 1 hazardous locations. To be located as close as practicable and, in no case, more than 18" from such enclosures
- In conduit systems when leaving Class I, Division 1 or Division 2 hazardous locations
- In cable systems when the cables either do not have a gas/vaportight continuous sheath or are capable of transmitting gases or vapors through the cable core when those cables leave the Class I, Division 1 or Division 2 hazardous locations

Features:

EYS and EZS sealing fittings include:

- Minimum turning radius
- Large openings with threaded closures to provide easy access to conduit hubs for making dams
- Integral bushings in conduit hubs to protect conductor insulation from damage
- Taper-tapped hubs to ensure ground continuity

EYS sealing fittings are available for installation in either vertical only or in both horizontal or vertical positions.

EZS sealing fittings for installation at any angle; the covers with opening for sealing compound can be properly positioned to accept the compound.

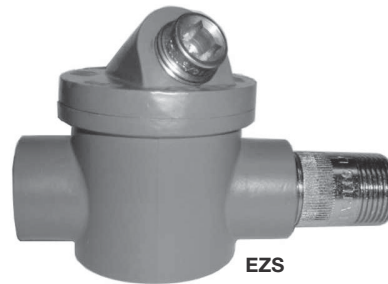

Certifications and Compliances:

- IEC:
 - Ex II 2 G EEx d IIC
 - EC-Type examination certificate LOM 03 ATEX 2108
- IP67 according to EN 60529

Standard Materials:

- Bodies – Light alloy, natural finish
- Plugs – Light alloy, natural finish
- Removable nipples – Light alloy, natural finish

Size Ranges:

- EYS - 1/2" – 4"
- EZS - 1/2" – 1"

Ordering Information:

Series	Mounting Direction	Hub Size	Cat. #
EYS	Vertical	1/2" NPT	NOR 000 002 220 117
EYS	Vertical	3/4" NPT	NOR 000 002 220 125
EYS	Vertical	1" ISO	NOR 000 002 220 133
EYS	Vertical	1" NPT	NOR 000 002 220 620
EYS	Horizontal	1 1/2" NPT	NOR 000 002 220 160
EYS	Horizontal	2" NPT	NOR 000 002 220 168
EZS	Horizontal	1/2" NPT	NOR 000 002 220 216
EZS	Horizontal	3/4" NPT	NOR 000 002 220 224
EZS	Horizontal	1" ISO	NOR 000 002 220 232
EZS	Horizontal	1" NPT	NOR 000 002 220 729

EYSA Flameproof Sealing Fitting



Applications:

EYSA sealing fittings:

- Restrict the passage of gases, vapors, or flames from one portion of the electrical installation to another at atmospheric pressure and normal ambient temperatures
- Limit explosions to the sealed off enclosure
- Prevent pre-compression or "pressure piling" in conduit systems

Sealing fittings are required:

- At each entrance to an enclosure housing an arcing or sparking device when used in Zone 1, hazardous locations to be located as close as practicable and in no case more than 450mm from such enclosures
- In conduit systems when leaving the Zone 1 area and entering an area of lesser hazard

Features:

- Minimum turning radius
- Large openings with threaded closures to provide easy access to conduit hubs for making dams
- Integral bushings to protect conductor insulation from damage
- Removable male nipple supplied when male and female hub style is ordered

Certifications and Compliances:

- Type of Protection: Ex d, DIP A21, T60°C, IP66
- Degree of Protection: IP66
- Gas Group: IIC
- Approvals: IEC Ex TSA07.0015-1

Standard Materials:

- Bodies - copper-free aluminum
- Removable nipples and plugs - brass

Standard Finishes:

- Body - polyurethane gray
- Nipples and plugs - natural

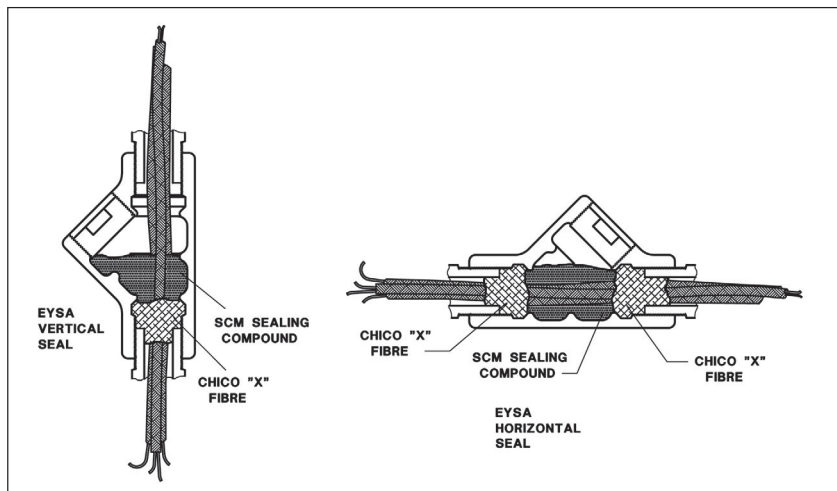
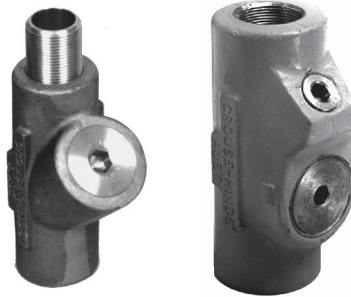

Ordering Information:

Entry Size	Female	Male & Female	Weight of Sealing Compound per Seal (g)	Weight of Chico X Fiber per Seal (g)
20mm/20mm	EYSA1M	EYSA16M	50	1
25mm/25mm	EYSA2M	EYSA26M	100	2
32mm/32mm	EYSA3M	EYSA36M	188	3.5
40mm/40mm	EYSA4M	EYSA46M	406	7
50mm/50mm	EYSA5M	EYSA56M	550	14
3/4" BSP/3/4" BSP	EYSA2B	EYSA26B	100	2
20mm/1/2" BSP	EYSA11MB	-	50	1
20mm/3/4" BSP	EYSA12MB	-	50	1
25mm/1/2" BSP	EYSA21MB	-	100	2
25mm/3/4" BSP	EYSA22MB	-	100	2

6F Conduit Sealing Fittings With Drains

Cl. I, Div. 1 & 2, Groups B, C, D§ Explosionproof
 Cl. II, Div. 1, Groups E, F, G Dust-Ignitionproof
 Cl. II, Div. 2, Groups F, G
 Cl. III

6F

Applications:

- EYD drain and EZD drain and inspection sealing fittings:
- Restrict the passage of gases, vapors or flames from one portion of the electrical installation to another at atmospheric pressure and normal ambient temperatures
 - Limit explosions to the sealed-off enclosure
 - Prevent precompression or "pressure piling" in conduit systems

Drain sealing fittings are installed in vertical conduit runs and at low points in conduit systems to prevent accumulation of condensate above seal.

For sealing fittings requirements see page 139.

Features:

- EYD and EZD drain sealing fittings include:
- Drain to provide continuous, automatic drainage of condensate
 - Large openings with threaded closures to provide easy access to conduit hubs for making dams
 - Integral bushings to protect conductor insulation from damage
 - Taper-tapped hubs to ensure ground continuity
- EZD drain and inspection sealing fittings also include:
- Removable covers for periodic inspection of seals
 - Barrier for sealing compound easily installed after dams are made and before compound is poured.

Certifications and Compliances:

- NEC/CEC:
 - EYD11-101, 116-1016**
 Class I, Division 1 & 2, Groups B, C, D
 Class II, Division 1, Groups E, F, G
 Class II, Division 2, Groups F, G
 Class III
 - EYD1-10, 16-106, EZD10-60, 111-611**
 Class I, Division 1 & 2, Groups C, D
 Class II, Division 1, Groups F, G
 Class II, Division 2, Groups F, G
 Class III
- UL Standard: 1203
- CSA Standard: C22.2

Standard Materials:

- Bodies, and inspection or drain covers – *Feraloy*® iron alloy and/or ductile iron
- Closure for drain – copper-free aluminum or ductile iron
- Small closure plug – *Feraloy* iron alloy and/or steel
- Drain – stainless steel
- Removable nipples – steel

Standard Finishes:

- Feraloy* iron alloy and ductile iron – electrogalvanized and aluminum acrylic paint
- Copper-free aluminum – natural
- Stainless steel – natural
- Steel – electrogalvanized

Options:

Description
 Copper-free aluminum bodies, nipples and enclosures

Suffix
 SA

Size Ranges:

- EYD – ½" – 4"
- EZD – ½" – 2"

Ordering Information - EYD



½" – 1"
 Female hub



½" – 1"
 Male & female hub



1¼" – 4"
 Female hub



1¼" – 4"
 Male & female hub

Hub Size	Female Hub Cat. #	Male & Female Hub Cat. #	Female Hub Cat. #	Male & Female Hub Cat. #	Approximate Internal Volume in Cubic Inches
½	EYD1*	EYD16*	EYD11	EYD116	1
¾	EYD2*	EYD26*	EYD21	EYD216	2
1	EYD3*	EYD36*	EYD31	EYD316	3¾
1¼	EYD4*	EYD46*	EYD41	EYD416	8
1½	EYD5*	EYD56*	EYD51	EYD516	10¾
2	EYD6*	EYD66*	EYD61	EYD616	20
2½	EYD7*	EYD76*	EYD71	EYD716	35
3	EYD8*	EYD86*	EYD81	EYD816	57
3½	EYD9*	EYD96*	EYD91	EYD916	75
4	EYD10*	EYD106*	EYD101	EYD1016	105

Dimensions In Inches

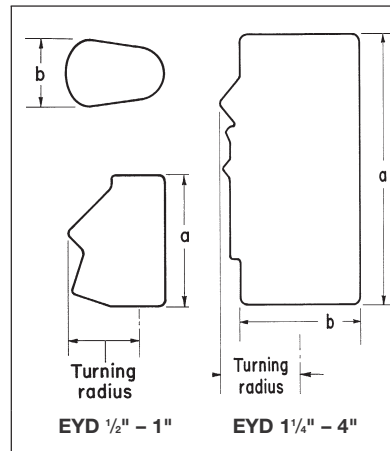

EYD Drain Seal

Size	a	b	Turning Radius
½	3 ³ / ₃₂	1¼	1 ⁵ / ₈
¾	3 ¹¹ / ₁₆	1½	1 ²⁹ / ₃₂
1	4 ³ / ₁₆	2 ³ / ₁₆	2 ³ / ₈
1¼	5 ¹ / ₁₆	2 ³ / ₁₆	1-27 ¹ / ₃₂ †
1½	5½	2 ⁷ / ₁₆	2-1 ¹ / ₁₆ †
2	6¼	3	2-5 ¹ / ₁₆ †
2½	7½	3½	2-11 ¹ / ₁₆ †
3	8½	4¼	3-5 ¹ / ₁₆ †
3½	9 ³ / ₁₆	4¾	3-7 ¹ / ₁₆ †
4	9¾	5¼	3-1½†

†With cover removed.
 *Available in copper-free aluminum – to order, add suffix SA to Cat. No.
 Sealing Fittings are approved for use in hazardous locations only when *Chico*® X fiber and *Chico A* sealing compound or *Chico SpeedSeal* are used to make the seal.
 §See Certifications and Compliances for classification of each product.

Conduit Sealing Fittings with Drain and Inspection Cover

Chico Sealing Compound and Fiber
see pages 155–156

Cl. I, Div. 1 & 2, Groups C, D Explosionproof
Cl. II, Div. 1, Groups E, F, G Dust-Ignitionproof
Cl. II, Div. 2, Groups F, G
Cl. III

6F

EZD With Drain Cover

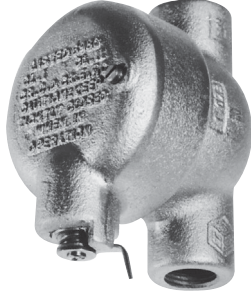

Hub Size	Cat. #	Approximate Internal Volume in Cubic Inches
1/2	EZD111	5
3/4	EZD211	6
1	EZD311	10
1 1/4	EZD411	11
1 1/2	EZD511	13
2	EZD611	40

Dimensions In Inches:

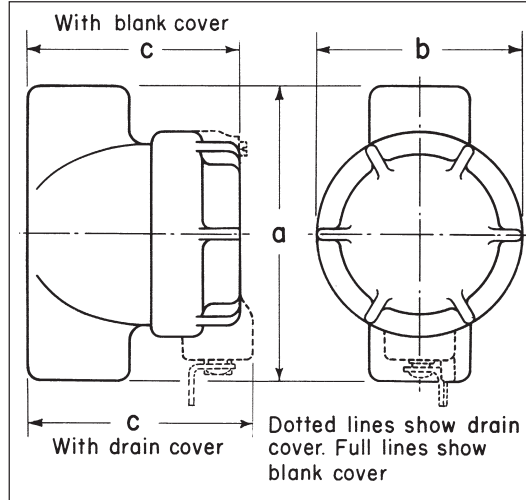

EZD Drain and Inspection Seals

Size	a	b	Drain Cover c	Turning Radius†
1/2	4 ³ / ₁₆	3	3 ³ / ₈	2 ¹ / ₁₆
3/4	4 ³ / ₁₆	3	3 ⁵ / ₈	2 ³ / ₁₆
1	4 ¹⁵ / ₁₆	3 ¹ / ₂	3 ⁷ / ₈	2 ⁷ / ₁₆
1 1/4	4 ¹⁵ / ₁₆	3 ¹ / ₂	4 ⁵ / ₁₆	2 ⁵ / ₈
1 1/2	5 ³ / ₁₆	3 ¹ / ₂	4 ⁹ / ₁₆	2 ¹¹ / ₁₆
2	7 ¹ / ₈	5 ¹ / ₁₆	5 ¹ / ₄	3 ¹¹ / ₁₆

†With cover removed.

6F

EYSX Expanded Fill Sealing Fittings

Chico Sealing Compound and Fiber see pages 155-156

Cl. I, Div. 1 & 2, Groups B, C, D§
 Cl. II, Div. 1, Groups E, F, G
 Cl. II, Div. 2, Groups F, G
 Cl. III

Explosionproof
 Dust-Ignitionproof

6F

Applications:

EYSX Expanded Fill Sealing Fittings:

- Restrict the passage of gases, vapors or flames from one portion of the electrical installation to another at atmospheric pressure and normal ambient temperatures
- Limit explosions to the sealed-off enclosure
- Limit precompression or "pressure piling" in conduit systems
- Provide 40% wire fill capacity to allow uninterrupted runs in a conduit system

Sealing fittings are required:

- At each entrance to an enclosure housing an arcing or sparking device when used in Class I, Division 1 and 2 hazardous locations. To be located as close as practicable and, in no case, more than 18" from such enclosures
- At each entrance of 2" size or larger to an enclosure or fitting housing terminals, splices or taps when used in Class I, Division 1 hazardous locations. To be located as close as practicable and, in no case, more than 18" from such enclosures
- In conduit systems when leaving Class I, Division 1 or 2 hazardous locations
- In cable systems when the cables either do not have a gas/vaportight continuous sheath or are capable of transmitting gases or vapors through the cable core when those cables leave the Class I, Division 1 or 2 hazardous locations

Features:

EYSX Expanded Fill Sealing Fittings provide:

- A 40% wire fill capacity for expanded fill sealing
- Large openings with threaded closures to provide easy access to conduit hubs for making dams
- Integral bushings in conduit hubs to protect conductor insulation from damage
- Taper-tapped hubs to ensure ground continuity
- Minimum turning radius

EYSX Expanded Fill Sealing Fittings are available for installation in both horizontal or vertical positions.

Certifications and Complies:

• NEC/CEC:

EYSX11 – EYSX81

Class I, Division 1 and 2, Groups B, C, D
 Class II, Division 1, Groups E, F, G
 Class II, Division 2, Groups F, G
 Class III

EYSX9, EYSX10, EYSX1 SA – EYSX10 SA

Class I, Division 1 and 2, Groups C, D
 Class II, Division 1, Groups E, F, G
 Class II, Division 2, Groups F, G
 Class III

- UL Standard: 1203
- CSA Standard: C22.2 No. 30

Standard Materials:

- Bodies – *Feraloy*® iron alloy and/or ductile iron or copper-free aluminum (SA Suffix)
- Closures – *Feraloy* iron alloy and/or steel or copper-free aluminum (SA Suffix)

Standard Finishes:

- Feraloy* iron alloy and ductile iron – electrogalvanized and aluminum acrylic paint
- Steel – electrogalvanized
- Copper-free aluminum – natural

Options:

Description
 Copper-free aluminum bodies and enclosures

Suffix

SA

Size Ranges:

- 1/2" – 4"

Ordering Information For Sealing in Vertical or Horizontal Positions

Hub Size	Female Cat. #	Internal Volume in Cubic Inches	
		Vertical	Horizontal
1/2	EYSX11*	2	2
1/2	EYSX1 SA	2	2
3/4	EYSX21*	3	3 3/4
3/4	EYSX2 SA	3	3 3/4
1	EYSX31	6	8
1	EYSX3 SA	6	8
1 1/4	EYSX41	19	22 3/4
1 1/4	EYSX4 SA	19	22 3/4
1 1/2	EYSX51	19	22 3/4
1 1/2	EYSX5 SA	19	22 3/4
2	EYSX61	56	64 1/2
2	EYSX6 SA	56	64 1/2
2 1/2	EYSX71	72	82
2 1/2	EYSX7 SA	72	82
3	EYSX81	95	110
3	EYSX8 SA	95	110
3 1/2	EYSX9*	200	222
3 1/2	EYSX9 SA	200	222
4	EYSX10*	200	222
4	EYSX10 SA	200	222



Vertical or horizontal female

Sealing fittings are approved for use in hazardous locations only when *Chico*® X fiber and *Chico A* sealing compound or *Chico SpeedSeal* are used to make the seal.

Dimensions

In Inches:

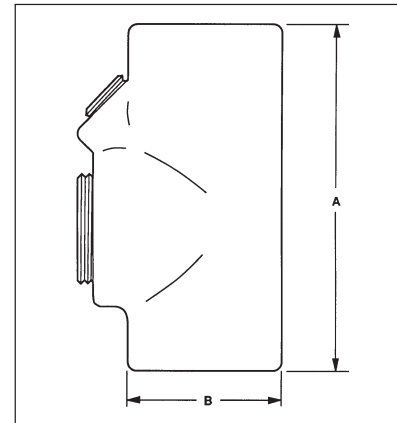

NPT Size	A	B	Turning Radius
1/2	3 11/16	1 1/2	1 1/4
3/4	4 5/16	1 3/4	1 3/8
1	5 1/16	2 3/16	1 23/32
1 1/4	6 7/4	3	2 5/16
1 1/2	6 1/4	3	2 5/16
2	8 1/2	4 1/4	3 5/16
2 1/2	9 7/16	4 3/4	3 -7/16‡
3	9 3/4	5 1/4	3 -11/16‡
3 1/2	11 1/16	6 1/2	4 -19/32‡
4	11 7/16	6 1/2	4 -19/32‡

§ See Certifications and Complies for classification of each product.
 ‡With plug cover removed.
 *Feraloy®

EYDX Expanded Fill Sealing Fittings With Drains

Chico Sealing Compound and Fiber
see pages 155–156

Cl. I, Div. 1 & 2, Groups B, C, D§
Cl. II, Div. 1, Groups E, F, G
Cl. II, Div. 2, Groups F, G
Cl. III

Explosionproof
Dust-Ignitionproof

6F

Applications:

EYDX Expanded Fill Sealing Fittings with drains:

- Restrict the passage of gases, vapors or flames from one portion of the electrical installation to another at atmospheric pressure and normal ambient temperatures
- Limit explosions to the sealed-off enclosure
- Prevent precompression or "pressure piling" in conduit systems
- Provide 40% wire fill capacity to allow uninterrupted runs in a conduit system

Drain sealing fittings are installed in vertical conduit runs and at low points in conduit systems to prevent accumulation of condensate above seal.

For sealing fittings requirements see page 139.

Features:

EYDX Expanded Fill drain sealing fittings provide:

- A 40% wire fill capacity for expanded fill sealing
- Drain to provide continuous, automatic drainage of condensate
- Large openings with threaded closures to provide easy access to conduit hubs for making dams
- Integral bushings to protect conductor insulation from damage
- Taper-tapped hubs to ensure ground continuity

Certifications and Compliances:

- NEC/CEC:
 - EYDX11 – EYDX81**
Class I, Division 1 and 2, Groups B, C, D
Class II, Division 1, Groups E, F, G
Class II, Division 2, Groups F, G
Class III
 - EYDX1 SA – EYDX8 SA**
Class I, Division 1 and 2, Groups C, D
Class II, Division 1, Groups F, G
Class II, Division 2, Groups F, G
Class III
- UL Standard: 1203
- CSA Standard: C22.2 No. 30

Standard Materials:

- Bodies and drain covers – *Feraloy*® iron alloy, and ductile iron or copper-free aluminum (SA Suffix)
- Closure for drain – copper-free aluminum or malleable iron
- Small closure plug – *Feraloy* iron alloy and/or steel or copper-free aluminum (SA Suffix)
- Drain – stainless steel

Standard Finishes:

- *Feraloy* iron alloy and ductile iron – electrogalvanized and aluminum acrylic paint
- Copper-free aluminum – natural
- Stainless steel – natural
- Steel – electrogalvanized

Options:

Description
Copper-free aluminum bodies and enclosures

Suffix
SA

Size Ranges:

- EYDX – ½" – 3"

Sealing Fittings are approved for use in hazardous locations only when *Chico*® X fiber and *Chico A* sealing compound or *Chico SpeedSeal* are used to make the seal.

Ordering Information

Hub Size	Female Hub Cat #	Internal Volume in Cubic Inches
½	EYDX11*	2
½	EYDX1 SA	2
¾	EYDX21*	3¾
¾	EYDX2 SA	3¾
1	EYDX31	8
1	EYDX3 SA	8
1¼	EYDX41	20
1¼	EYDX4 SA	20
1½	EYDX51	20
1½	EYDX5 SA	20
2	EYDX61	57
2	EYDX6 SA	57
2½	EYDX71	75
2½	EYDX7 SA	75
3	EYDX81	105
3	EYDX8 SA	105

§ See Certifications and Compliances for classification of each product.
* *Feraloy*®

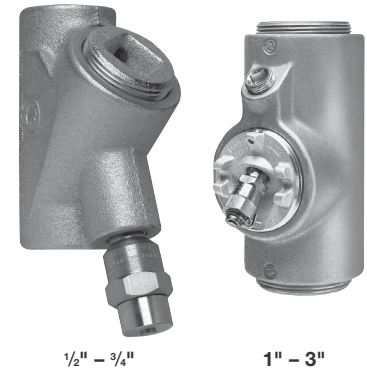

Dimensions In Inches:

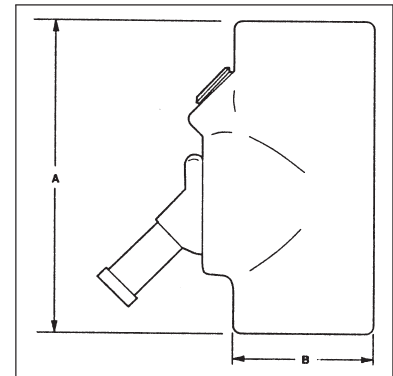

EYDX NPT

Size	A	B	Turning Radius
½	3 ¹¹ / ₁₆	1 ³ / ₄	1 ²⁹ / ₃₂
¾	4 ⁵ / ₁₆	2 ³ / ₁₆	2 ³ / ₁₆
1	5 ¹ / ₁₆	2 ³ / ₁₆	1 ⁻²⁷ / ₃₂ †
1¼	6 ¹ / ₄	3	2 ⁻⁵ / ₁₆ †
1½	6 ¹ / ₄	3	2 ⁻⁵ / ₁₆ †
2	8 ¹ / ₂	4 ¹ / ₄	3 ⁻⁵ / ₁₆ †
2½	9 ³ / ₁₆	4 ³ / ₄	3 ⁻⁷ / ₁₆ †
3	9 ³ / ₄	5 ¹ / ₄	3 ⁻¹ / ₂ †

†With drain cover removed.

Crouse-Hinds

by **E.T.N**

EYSR Retrofit Sealing Fitting

Chico Sealing Compound and Fiber see pages 155–156

Cl. I, Div. 2, Groups C, D
 Cl. II, Div. 2, Groups E, F, G
 Explosionproof
 Dust-Ignitionproof

6F

Applications:

- EYSR retrofit sealing fittings are installed:
- In rigid metal conduit systems in Class I, Division 2 hazardous locations
 - To replace installed Eaton's Crouse-Hinds type EYS or EYD sealing fittings
 - Without disassembly of the conduit system
 - In vertical or horizontal positions, indoors or outdoors
 - To restrict the passage of gases, vapors, or flames from one portion of the electrical system to another at atmospheric pressures and normal ambient temperatures
 - To limit explosions to the sealed-off enclosure
 - To limit precompression or "pressure piling" in the conduit system
 - To prevent accumulation of water in the conduit system when installed with an ECD15 drain

Features:

- Seal may be installed in the existing conduit run without disassembly of the conduit system saving time and labor
- Overall length and spacing requirements do not exceed those of standard EYS seals; permits close nesting of seals
- Pipe plugs permit the installation of a standard ECD15 drain fitting (order separately) for use in vertical conduit runs to drain any water that might accumulate in the conduit system
- Steel set screws provide grounding continuity
- Suitable for vertical and horizontal installations for indoor and outdoor applications
- Available in 3/4" to 4" NPT sizes

Certifications and Compliances:

- NEC:
 - Class I, Division 2, Groups C, D
 - Class II, Division 2, Groups E, F, G
- UL Standard: 1203
- CEC:
 - Class I, Division 1, Groups C, D
 - Class II, Division 1, Groups E, F, G
- CSA Standard: C22.2 No. 30

EYSR sealing fittings are approved for use in hazardous locations only when *Chico*® A sealing compound and *Chico X* fiber are used to make the seal.

Standard Materials:

- Body – *Feraloy*® iron alloy
- Pipe plugs, bolts and set screws – steel
- Gasket – neoprene

Standard Finishes:

- *Feraloy* iron alloy – electrogalvanized and aluminum acrylic paint
- Steel – electrogalvanized
- Gasket – natural

Options:

Description
 Copper-free aluminum

Suffix
 SA

Size Ranges:

- 3/4" – 4"



Ordering Information

Hub Size	Cat. #	Approximate Internal Volume in Cubic Inches*		Approximate Amount (oz.) of Fiber per Hub	
		Vert.	Horiz.	Vert.	Horiz.
3/4	EYSR2	3 1/2	5 3/4	1/16	1/8
1	EYSR3	4 3/4	9 1/2	1/8	1/4
1 1/4	EYSR4	7	13 1/2	1/4	1/2
1 1/2	EYSR5	12 1/4	24 1/4	1/2	1
2	EYSR6	25 1/4	40 1/2	1	2
2 1/2	EYSR7	48	75 1/2	1 1/2	3
3	EYSR8	86 1/2	126	2	4
3 1/2	EYSR9	147	210	4 1/2	9
4	EYSR10	186	252	4 1/2	9

*Use the approximate internal volume in cubic inches to determine how much Chico A sealing compound is required.

Dimensions In Inches:

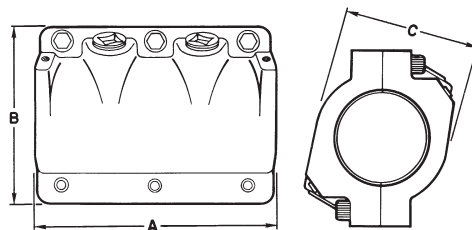

Cat. #	A	B	C	Cat. #	A	B	C
EYSR2	3 11/16	2 1/2	1 1/2	EYSR7	7 1/2	5	3 3/8
EYSR3	4 3/8	3 1/8	3 3/8	EYSR8	8 1/2	5 1/2	4 1/4
EYSR4	5	3 3/8	3	EYSR9	9 13/64	6 1/16	4 3/4
EYSR5	5 1/4	3 5/8	3	EYSR10	9 3/4	6 5/8	5 1/4
EYSR6	6 1/4	4	3				

ES Sealing Hubs

Cl. I, Div. 1 & 2, Groups C, D
Explosionproof
Watertight

6F

Chico Sealing Compound and Fiber
see pages 155–156

Applications:

ES sealing hubs are used to:

- Seal vertical conduit risers at switchgear and motor control centers, sheet metal structures or cast boxes and enclosures
- Seal horizontal conduit runs at enclosures when used with TSC sealing compound



Certifications and Compliances:

- Class I, Division 1 & 2, Groups C & D
- UL Standard: 1203
- CSA Standard: C22.2 No. 30

Standard Materials:

- Feraloy® iron alloy

Standard Finishes:

- Electrogalvanized and aluminum acrylic paint

Options:

ES sealing hubs, when used with SG armored gaskets and locknuts, provide a water and oiltight connection

Description

Sealing gaskets and locknuts

Suffix
SG

Ordering Information

Female Hub Size	Male Hub Size	Cat. #	Approximate Internal Volume in Cubic Inches
1/2	1	ES31	.65
3/4	1	ES32	.65
1	1 1/2	ES53	3.2
1 1/4	2	ES64	4.9
1 1/2	2	ES65	4.7
2	2 1/2	ES76	9.1
3	4	ES108	36.0
4	5	ES01210	95.0
5	6	ES014012	155.0

Note: Sealing hubs are approved for use in hazardous locations when *Chico*® X fiber and *Chico* A sealing compound are used to make the seal. Sealing hubs are approved for horizontal conduit runs for use in hazardous locations when used with TSC sealing compound, order 1 oz. tube as TSC1.

TSC Epoxy Sealing Compound



A two part epoxy sealing compound may be used to seal ES sealing hubs. It is quick and easy to measure, mix and install. The compound is kneaded until a uniform color is obtained. It is then packed around the conductors to effectively seal the cable.

Std. Ctn. Qty.	Tube Size	Cat. #†
10	0.5 oz	TSC05
10	1.0 oz	TSC1
5	4.0 oz	TSC4

†Order quantity of one (1) TSC05 or TSC1 equals 10 tubes; one (1) TSC4 equals 5 4.0 oz tubes.

Typical Installations

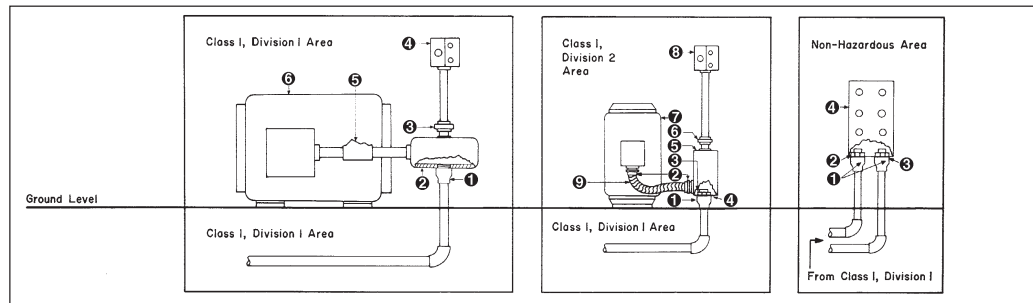

1. ES Sealing Hub
2. EJB Junction Box
3. UNY Union
4. EDS Factory Sealed Control Station
5. EYS Horizontal Seal
6. Explosion-Proof Motor

1. ES Sealing Hub
2. LT Connector
3. Locknut
4. Sealing Gasket
5. Junction Box
6. UNY Union
7. Synchronous Motor
8. EDS Factory Sealed Control Station
9. LT Conduit

1. ES Sealing Hub
2. Locknut
3. Sealing Gasket
4. Sheet Metal Structure, Motor Control Center, Panelboard, Unit Substation, Etc.

Dimensions In Inches:

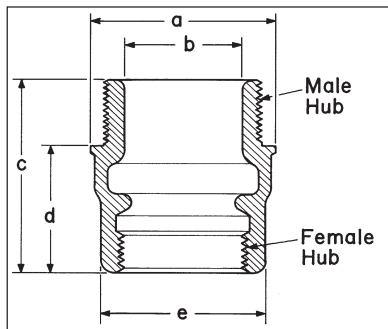

Cat. #	a	b	c	d	e
ES31	1 9/16	7/8	2	2 9/32	1 1/4
ES32	1 13/16	7/8	2	2 5/32	1 1/2
ES53	2 1/4	1 3/8	2 3/4	1 15/16	1 3/4
ES64	2 3/4	1 3/4	2 3/4	1 15/16	2 3/16
ES65	2 3/4	1 5/8	3 1/16	2	2 1/16
ES76	3 1/2	2 1/16	3 9/16	2	3
ES108	5 1/4	3 5/8	4 3/4	2 31/32	4 1/4
ES01210	6 5/8	4 5/8	6 3/4	4 27/32	5 1/4
ES014012	7 1/4	5 25/32	7 1/4	5 11/32	6 1/2

Crouse-Hinds

by E.T.N

6F Ultra High Pressure Seal

Cl. I, Div. 1, Groups B, C, D
 Certified to CSA Standards through QPS

Rated to 1500 PSI

6F

Applications:

- If the primary seal in an instrument should fail, the Eaton's Crouse-Hinds Ultra High Pressure Seal (UHPS) will prevent gases from migrating through the electrical system into a non-classified location.
- Are designed to prevent the passage of gases under pressure through conduits, cables and conductors.
- Are ideal where volatile liquids or gases are stored, processed or transported under pressure.

Certifications & Compliances:

- Class I, Division 1, Groups B, C, D
- Certified to CSA Standards through QPS
- 24 Volt DC - 120 Volt AC
- Wire grade is rated to a 600 Volt safety factor
- 1/2" MNPT x 1/2" NPT
- Conforms to Section 18-108 and 18-158 of the CEC® for The Requirements of a Secondary Seal.

Standard Materials & Finishes:

- Stainless steel body - natural finish

Quality Assurance:

Each fitting is tested at 1.5 times working pressure (max. working pressure 1500 PSI) as a gas and liquidtight explosionproof fitting. Each seal is also di-electric and resistance tested.

Ordering Information:

Catalog Number	Description
CH6DR500X002D14G	UHPS, 2 wire, 14 gauge
CH6DR500X002D16G	UHPS, 2 wire, 16 gauge
CH6DR500X002D18G	UHPS, 2 wire, 18 gauge
CH6DR500X002D22G	UHPS, 2 wire, 22 gauge
CH6DR500X004D14G	UHPS, 4 wire, 14 gauge
CH6DR500X004D16G	UHPS, 4 wire, 16 gauge
CH6DR500X004D18G	UHPS, 4 wire, 18 gauge
CH6DR500X004D22G	UHPS, 4 wire, 22 gauge
CH6DR500X234D14G	UHPS, 4 wire, 14G, 2' input, 3' output
CH6DR500X264D16G	UHPS, 4 wire, 16G, 2' input, 6' output
CH6DR500X294D16G	UHPS, 4 wire, 16G, 2' input, 9' output
CH6DR500X2D2D16G	UHPS, 2 wire, 16G, 2' input, CF output

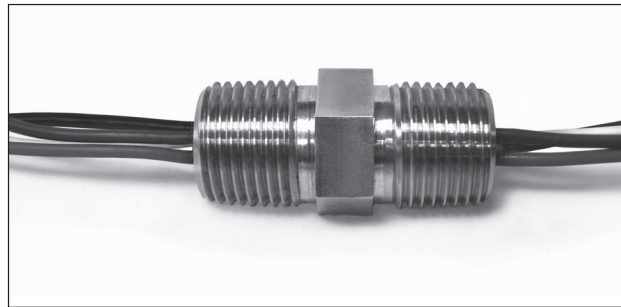
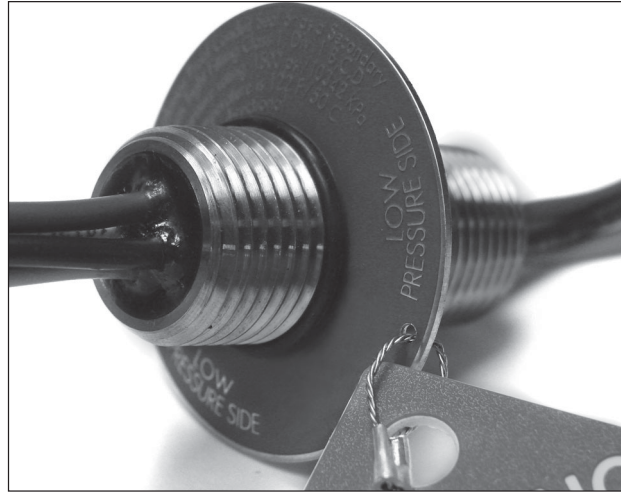

INSTALLATION EXAMPLE:

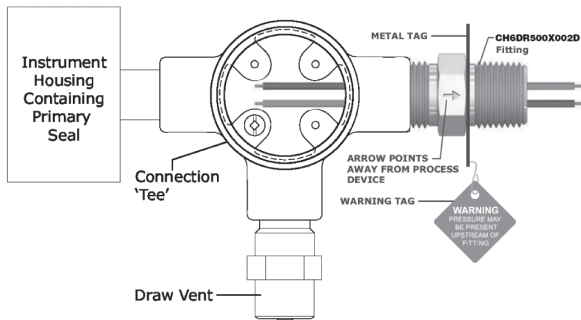

Secondary Process Seal Assemblies

Cl. I, Div. 1 & 2, Groups B, C, D NEMA 3, 4, 7BCD, 9
 Cl. I, Zone 1 & 2 IIB + H₂
 Cl. II, Div. 1 & 2, Groups E, F, G

6F



Applications:

Eaton's Crouse-Hinds Secondary Process Seal Assembly with Rupture Indication Sensor is designed to prevent the passage of gases under pressure through conduit, cables and conductors while providing immediate notification of a dangerous, potentially explosive seal rupture. These assemblies are ideal where volatile liquids or gases are stored, processed or transported under pressure. If the primary seal in an instrument should fail, the Eaton's Crouse-Hinds Secondary Process Seal will prevent gases, vapors and liquids from migrating into the non-classified location through the electrical system.

Rupture Indication Sensor:

The Secondary Process Seal features a rupture indication sensor that opens safely at 60 psi minimum and activates a circuit to a control system or alarm, which immediately alerts maintenance personnel that the primary seal has ruptured. The location of the problem can be pinpointed so the problem can be quickly addressed.

Innovative, intelligent technology combined with easy installation and low maintenance cost provides a safe and reliable solution for detection of a process seal rupture within your facility.



Features and Benefits:

Secondary Process Seal

- CSA and CSAus certified
- Meets or exceeds ANSI / ISA / CSA / CEC / NEC / API requirements for a secondary process seal and explosionproof conduit seal
- Sealed to 1500 psi, operates in any position
- Simplified design allows for easier installation in new and existing applications
- Integrated packaging contains all necessary components for installation
- The explosionproof drain allows for the safe release of gas, vapor or liquid from the electrical system to meet required codes
- Explosionproof terminal box features a simple design to provide access for quick connection of circuits
- Assembly with drain provides local "make obvious" indication of primary seal failure

Rupture Indication Sensor

- Rupture detection and indication at 60 psi
- Provides remote, immediate notification of a seal rupture, allowing for maintenance to quickly address the problem and isolate safety concerns
- Stainless steel construction provides superior corrosion resistance and durability

Ordering Information:

	Assembly with Vent/Drain	Assembly with Rupture Indication Sensor and Vent/Drain
2 wire, 14 gauge	SPS214	SPS214R
2 wire, 16 gauge	SPS216	SPS216R
2 wire, 18 gauge	SPS218	SPS218R
2 wire, 22 gauge	SPS222	SPS222R
4 wire, 14 gauge	SPS414	SPS414R
4 wire, 16 gauge	SPS416	SPS416R
4 wire, 18 gauge	SPS418	SPS418R
4 wire, 22 gauge	SPS422	SPS422R

For Process Seal Rupture Indication Sensor replacement, order catalog #PSRIS.

Options:

Description	Suffix
No terminal blocks	(leave option blank)
2 terminal blocks	DIN12
4 terminal blocks	DIN14

6F

Assembly Information

Assembly with process seal rupture indication sensor

Terminal Housing

- Cast ears on cover permit easy opening and tightening
- Neoprene o-ring meets NEMA 4 requirements
- Compact, explosionproof design
- Various termination methods available
- DIN rail mounted terminal blocks provided as option

Ultra High Pressure Seal (UHPS) (available separately)

- Rated to 1500 PSI
- 2 or 4 wire versions available
- Conductors available in 14, 16, 18, and 22 gauge
- Two foot pigtail leads
- Additional conduit seal not required

Connects to 1/2" threaded hub of process vessel sensor / instrument with primary seal (see drawing below)

Process Seal Rupture Indication Sensor (PSRIS) (available separately)

- Switch is activated (open) when the primary seal is ruptured, by Hall Effect (magnetic)
- Switch activates at internal pressure of 60 psi or higher*
- Must be wired as intrinsically safe (Div. 1, Zone 1) or non-incendive (Div. 2, Zone 2)
- 2 meter silicon cable

Explosionproof Vent / Drain

- Patented labyrinth design
- NEMA 4 rated

Installation Example

- Explosionproof seal not required if process device or sensor is labeled "factory-sealed" or "seal not required"

*60 psi internal pressure rating at 25°C ambient. Activation pressure may vary +/- 10% depending on ambient variation.

Secondary Process Seal Assemblies

Cl. I, Div. 1 & 2, Groups B, C, D NEMA 3, 4, 7BCD, 9
 Cl. I, Zone 1 & 2 IIB + H₂
 Cl. II, Div. 1 & 2, Groups E, F, G

6F



Installation Examples

Secondary Process Seal with local "make obvious" indication using an ECD explosionproof drain

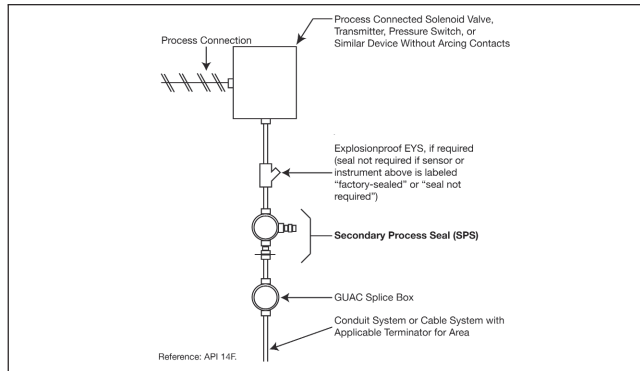

Secondary Process Seal with Rupture Indication Sensor for remote indication, and ECD explosionproof drain for local "make obvious" indication

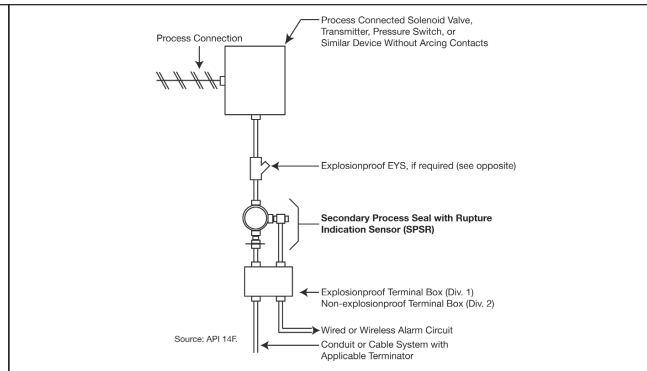

Technical Data - Assembly

Product Certification

The Secondary Process Seal and Assemblies are CSA certified (Canada, U.S.)

Operating Pressure Rating

Rupture protection to 1500 psi
 Rupture indication at 60 psi minimum

Operating Temperature Range

-25°C to +50°C

Note: For more extreme temperature and/or pressure requirements, please consult factory.

Technical Data - Components

Components	Construction	Certifications and Compliances	Rating	Area Suitability
Process Seal Rupture Indication Sensor	Hub - 316 stainless steel	ANSI / ISA 12.27.01 - 2003 CEC 18 - 108, 158 NEC 501.15(F)(3)	-	Cl. I, Div. 1 & 2, Groups B, C, D Cl. II, Div. 1 & 2, Groups E, F, G Zone 1 IIB+H ₂ and Zone 2 IIB+H ₂ NEMA 3, 4, 7BCD, 9
	Switch Assembly - hermetically sealed, nickered brass, with silicon cable	(Div. 1, Zone 1) intrinsically safe (Div. 2, Zone 2) non-incendive Simple apparatus (NEC 504.4)	174 mA 24VDC T6 (Tamb ≤ 40°C) T5 (40°C < Tamb ≤ 55°C) T4 (55°C < Tamb ≤ 80°C)	
Ultra High Pressure Seal	Stainless steel	CSA 22.2 No. 30 - 03 CSA 22.2 No. 14 - 2005 ANSI / ISA 12.27.01 - 2003 CEC 18 - 108, 158 NEC 501.15(F)(3)	24VDC 120VAC	
Terminal Housing	Copper-free aluminum	UL1203 CSA C22.2 No. 30	-	
Drain / Vent	Stainless steel	UL1203 CSA C22.2 No. 30	-	

6F Secondary Process Seal Assemblies

Cl. I, Div. 1 & 2, Groups B, C, D NEMA 3, 4, 7BCD, 9
 Cl. I, Zone 1 & 2 IIB + H₂
 Cl. II, Div. 1 & 2, Groups E, F, G

6F

Dimensions (Inches):

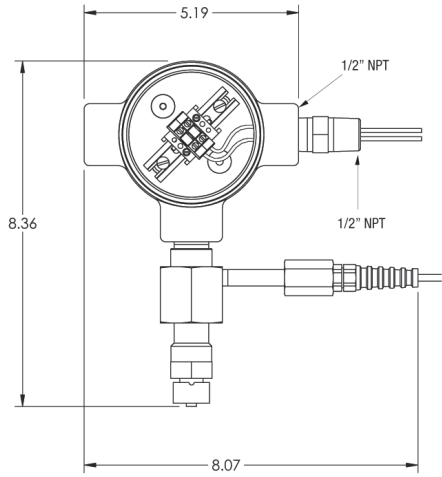

Assembly with rupture sensor and vent/drain

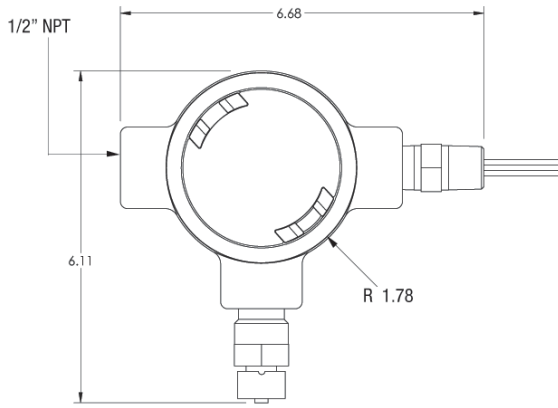

Assembly with vent/drain

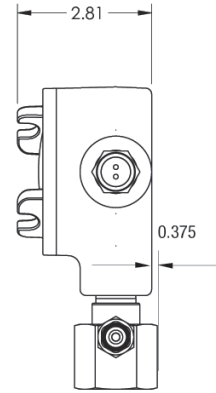

Note: Assemblies shown with DIN12 terminal blocks (optional)

Chico® A and Chico® A-P Sealing Compound

Chico® X Fiber

Chico® SpeedSeal™

For Sealing Fittings and Hubs

6F



Applications:

Chico X fiber:

- Forms a dam between the integral bushing of the sealing fitting and the end of the conduit and around the electrical conductors entering the hub

Chico A sealing compound:

- Forms a seal around each electrical conductor and between them and inside of the sealing fitting to restrict the passage of gases, vapors or flames through the sealing fitting at atmospheric pressure and at normal ambient temperatures

Chico® SpeedSeal™ Compound:

- Designed to separate and form an explosionproof seal around each electrical conductor in Eaton's Crouse-Hinds EYS and EYD sealing fittings
- Restricts the passage of gases, vapors or flames through the sealing fitting
- Creates a seal for Class I, Division 1, Groups C, D and Class II, Division 1, Groups E, F, G hazardous areas

Features:

Chico A sealing compound:

- A water soluble powder that can be easily mixed and poured. The compound, unusually dense, expands slightly when hardening and bonds to inner walls of sealing fittings. Compound hardens in 60–70 minutes
- Chico A cure time is 8 hours for Class I, Group C and D applications and 72 hours for Class I, Group A and B applications.
- Chico A has a 1 year shelf life from date of manufacture.
- Chico A ambient temperature range (after curing) is –40°F to +165°F.

Chico A-P Intrapak®:

- Packaged in two-compartment plastic pouch with precise amount of water for mixing. No mixing or measuring implements required.
- A hard squeeze of the water compartment forces the water into the compartment containing the Chico compound. Mixing is completed by kneading the pouch for one minute.
- The mixed sealing compound is poured directly into the sealing fitting – no funnel required. The package label indicates the size and quantity of sealing fittings each pouch will properly fill. Compound hardens in 60–70 minutes.

Chico X fiber:

- A mineral wool that packs easily, forming around each conductor

Chico® SpeedSeal™ Compound:

- Installs a reliable seal in five minutes - *every time*
- Hardens to a dense, strong mass that is suitable for Class I, Division 1, Groups C, D and Class II, Division 1, Groups E, F, G hazardous applications.
- UL and cUL Listed for use with 1/2" to 2" Eaton's Crouse-Hinds sealing fittings only.
- Packaged in a 2 oz. or 6 oz. pre-measured cartridge, eliminating the need for measuring before mixing.
- Packaged with a screw-on nozzle for accurate dispensing.
- Expands four times its original size in the sealing fitting, eliminating the need to separate the individual conductors with Chico X fiber.
- Chico X fiber dams are not required in horizontal applications, reducing installation times.
- Completely hardens in 20 minutes, simplifying use for OEMs.
- Suitable for cold temperature environments without the costly need to build a temporary shelter around sealing fittings. All ice crystals must be removed from inside the conduit seal before dispensing Chico SpeedSeal compound. The Chico SpeedSeal compound should be kept above 10°C (50°F) and below 85°F (29°C) prior to mixing. The sealing fitting must be kept at or above 4°C (40°F) during the 4 to 10 minute expansion/gel time of the compound.
- 18 months shelf-life.
- Patent pending.

Crouse-Hinds

by **E:T:N**

Size Ranges:

- *Chico A* compound – 1 lb. to 5 lbs. (provides 23–115 cubic inches of compound)
- *Chico X* fiber – 2 oz. to 1 lb.
- *Chico A-P* (5 pouches per carton) – provides 25 and 55 cubic inches of compound
- *Chico SpeedSeal* - 2 oz. or 6 oz. cartridge

Eaton's Crouse-Hinds sealing fittings are approved for use in hazardous locations only when *Chico X* fiber and *Chico A* Sealing Compound or *Chico SpeedSeal* are used to make the seal.

Ordering Information - Chico A



Net Weight	Vol. Cu. In.†	Cat. #
1 lb.	23	Chico A3
1 lb.‡	23	Chico A4
5 lb.	115	Chico A05

Ordering Information - Chico A-P Intrapak®



Cu. In. Fill per Pouch†	No. of Pouches per Carton	Cat. #
5	5	Chico A19 PX*
11	5	Chico A39 PX*

*A sixth pouch, containing an appropriate quantity of Chico X fiber, is included in these cartons.

†Number of cubic inches this amount will fill when set. See internal volume requirements for EYS, EZS, EYD, EZD and EYSR sealing fittings and ES sealing hubs (see pages 140–149).

‡Includes 1 oz. Chico X fiber.

6F Chico® A and Chico® A-P Sealing Compound Chico® X Fiber Chico® SpeedSeal™ For Sealing Fittings and Hubs

6F

Ordering Information - Chico X Fiber

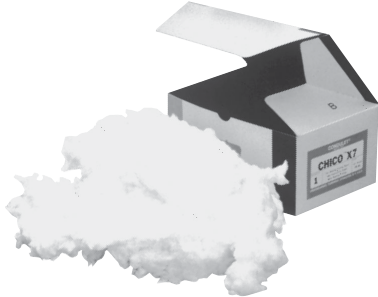

Net Weight	Cat. #
2 oz.	Chico X4
8 oz.	Chico X6
1 lb.	Chico X7

Chart for Approximate Amount of Fiber Per Hub

Hub Size	Ozs. Required
1/2	1/32
3/4	1/16
1	1/8
1 1/4	1/4
1 1/2	1/2
2	1
2 1/2	1 1/2
3	2
3 1/2	3
4	4 1/2
5	7
6	10

Ordering Information - Chico SpeedSeal

Class I, Div. 1, Groups C & D and Class II, Div. 1, Groups E, F and G



Sealing Fitting Cat. #	Amount of SpeedSeal Material needed per fitting (in ounces)	SpeedSeal Cat. #
EYS1, EYS16; EYS11, EYS116 EYD1, EYD16, EYD11, EYD116 EYS2, EYS26, EYS21, EYS216 EYD2, EYD26, EYD21, EYD216 EYSX11, EYDX11	1	CHICO SS2 (2 oz. Cartridge)
EYS3, EYS36, EYS31, EYS316 EYD3, EYD36, EYD31, EYD316 EYSX21, EYDX21	2	CHICO SS2 (2 oz. Cartridge)
EYS41, EYS416, EYS4, EYS46 EYD4, EYD46, EYD41, EYD416 EYS51, EYS516, EYS5, EYS56 EYD5, EYD56, EYD51, EYD516 EYSX31, EYDX31 EYSX41, EYDX41	3	CHICO SS6 (6 oz. Cartridge)
EYS61, EYS616, EYS6, EYS66 EYD6, EYD66, EYD61, EYD616 EYSX51, EYDX51	6	CHICO SS6 (6 oz. Cartridge)

MSDS sheets are available at www.crouse-hinds.com

For Use with Sealing Fittings and Hubs

Eaton's Crouse-Hinds EYS Tool Kit lets you safely and reliably pack the fiber dam in explosionproof sealing fittings. Consisting of five patented, two-sided tools in a handy canvas bag, the EYS Tool Kit makes the critical steps of separating electrical conductors and packing fiber dams quick and easy.

Features and Benefits:

- The EYS Tool Kit consists of five tools and a canvas tool bag. Four tools have two unique ends for a total of 9 different tools.
- Each tool is numbered for easy identification.
- Tools are constructed of durable plastic with smooth and rounded surfaces that will not abrade the electrical insulation.
- The Hook tool (#3) with a large hook on one end and a small hook on the other end is designed to lift and separate individual wires.
- The Packing tools (#1, #2 & #4) have rounded ends designed for packing fiber in between and around electrical conductors.
- The Wedge tools (#2 & #5) are designed for hands-free separation of conductors while packing fiber.
- The Mirrored tool (#5) allows for easy inspection of the sealing fittings.
- All tools are sized and precisely angled to accommodate various sizes of fittings.
- The canvas tool bag is designed to neatly store and protect tools while not in use.



Ordering Information

Description	Cat. #
EYS Tool Kit	EYS TOOL KIT

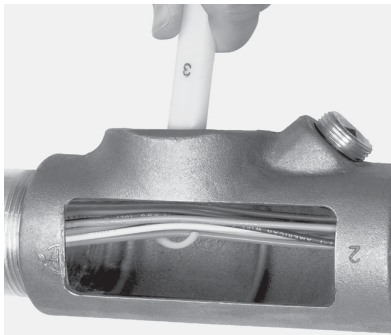

The large hook on Tool #3 quickly lifts all the conductors.

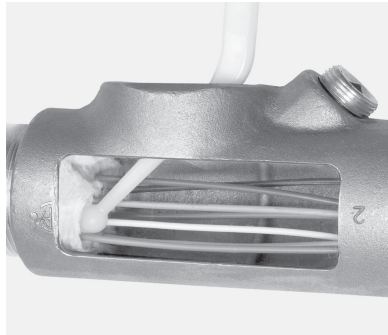

With one of the packing tools, packing fiber in between and around electrical conductors is effortless.

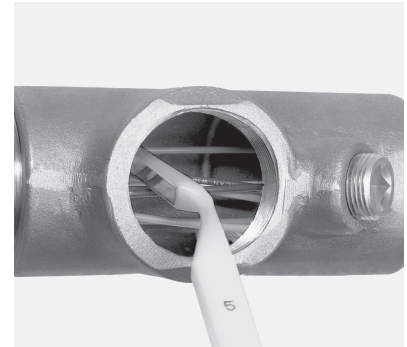

The mirrored tool allows for proper inspection of the fiber dam in difficult to see areas.

6F Drains and Breathers

Cl. I, Div. 1 & 2, Groups B, C, D
 Cl. II, Div. 1, Groups E, F, G
 Cl. II, Div. 2, Groups F, G
 Cl. III

II 2 G Ex d IIB (ECD15)
 II 2 G Ex d IIB + Hydrogen
 (ECD Type 4X Series)
 Explosionproof
 Dust-Ignitionproof

6F

Applications:

- ECD drains and breathers are installed in enclosures or conduit systems to:
 - Provide ventilation to minimize condensation
 - Drain accumulated condensate
- At least one breather should be used with each drain
- A breather is installed in top of enclosure or upper section of conduit system
- A "standard" drain is installed in bottom of enclosure or in lower section of conduit system
- "Universal" breather or drain functions as a breather when mounted at the top of an enclosure, or as a drain when mounted in the bottom of an enclosure
- "Combination" breather and drain is used in those applications where the use of a top mounted breather is not practical due to limited space; or in offshore and marine installations where moisture may enter the enclosure through the breather located on top of enclosure
- Drains and breathers are installed in hubs or drilled and tapped openings

Features:

ECD284, ECD384, ECD385 and ECD15 "Universal" drains and breathers have:

- Patented labyrinth design, suitable for use in Class I, Division 1 & 2, Groups C,D and Class II, Division 1 & 2, Groups F,G areas
- Capability to pass 50 cc of water per minute and 0.2 cubic feet of air per minute at atmospheric pressure
- ECD15 and ECD385 each have a well inside the inner, threaded end to provide for accumulation of sediment without clogging when used as a drain

"Standard" ECD drains and breathers have:

- Thread-in-thread design, suitable for use in Class I, Division 1 & 2, Groups C,D; Class II, Division 1, Groups E,F,G; Class II, Division 2, Groups F,G and Class III areas
- ECD 11, 13 have capability to pass 25 cc of water per minute and .05 cubic feet of air per minute at atmospheric pressure
- ECD387 and ECD16 are a unique thread-in-shaft design for use in Class I, Division 1 & 2, Groups B,C,D; Class II, Division 1, Groups E,F,G; Class II, Division 2, Groups F,G; Class III areas. The ECD387 and ECD16 can pass 15cc of water per minute. The ECD16 can pass .01 cubic feet of air per minute.

"Combination" ECD breather and drain:

- Provides ventilation to minimize condensation and drains accumulated condensate – two functions performed by a single device installed in the bottom of an enclosure or conduit system
- Have the capability to pass 25 cc of water per minute and .10 cubic feet of air per minute at atmospheric pressure
- Thread-in-thread and labyrinth design, suitable for use in Class I, Division 1 & 2, Groups C and D; Class II, Division 1 & 2, Groups F and G; and Class III areas

Certifications and Compliances:

- NEC/CEC:
 - ECD 16, ECD387, ECD-N4D, ECD-N4B** – Class I, Division 1 & 2, Groups B, C, D
Class II, Division 1, Groups E, F, G
Class II, Division 2, Groups F, G
Class III
IP46 (ECD-N4D and ECD-N4B only)
IIB + Hydrogen (ECD-N4D and ECD-N4B only)
 - ECD11, ECD13, ECD281** – Class I, Division 1 & 2, Groups C, D
Class II, Division 1, Groups E, F, G
Class II, Division 2, Groups F, G
Class III
 - ECD18, ECD384, ECD15, ECD385** – Class I, Division 1 & 2, Groups C, D
Class II, Division 1, Groups F, G
Class II, Division 2, Groups F, G
Class III
IP42 IIB (ECD 15 only)
 - ECD284** – Class I, Division 1 & 2, Group C, D
Class II, Division 1, Groups F, G
Class II, Division 2, Groups F, G
- UL Standard: 1203
- CSA Standard: C22.2 No. 30
- Type 4X: ECD-N4D and ECD-N4B
- ATEX Certificate # ITS07ATEX15639U

Standard Materials:

- ECD11, ECD15, ECD281, ECD284, ECD384, ECD385 – stainless steel
- ECD13 – stainless steel with aluminum cap
- ECD16, ECD-N4D, ECD-N4B – stainless steel
- ECD387 – stainless steel
- ECD18 – stainless steel with neoprene tube

Size Ranges:

- 1/4" to 1/2"

Breather



Drain

Typical installation of drain and breather in a combination motor starter

- At least 5 full threads of drain or breather must be engaged in matching female thread, taper-tapped in accordance with NEMA/EEMAC Standard FB-1, Type NTC or National Bureau of Standards Handbook H28, Part II, Table 7.6.
- These breathers and drains can be factory installed on various explosion-proof equipment. See options on applicable equipment pages for suffixes to be used.



ECD11



ECD13



ECD15



ECD16



ECD18

Ordering Information ECD "Type 4X" Drain and Breather

Size	Drain Cat. #	Breather Cat. #
3/8	ECD38 N4D	ECD38 N4B
1/2	ECD1 N4D	ECD1 N4B

ECD "Standard" Drain and Breather

Size	Drain Cat. #	Breather Cat. #
1/4	ECD281	
3/8	ECD387	
1/2	ECD11	ECD13

ECD "Universal" Drain or Breather

Size	Cat. #
1/4	ECD284†
3/8	ECD384†
3/8	ECD385
1/2	ECD15
1/2	ECD16

†Shorter overall length than ECD15 and ECD385. For use in confined spaces such as panelboard assemblies.

ECD "Combination" Drain or Breather

Size	Cat. #
1/2	ECD18

Straight Body • Male Thread

Applications:

CD Series drains are for use in conduit systems to:

- Drain accumulated condensate.
 - Provide ventilation to minimize condensation.
- Drains are installed in hubs or drilled and tapped openings.

Certifications and Compliances:

- UL Standard 514B

Standard Materials:

- CD bodies and nuts – steel or aluminum
- CD screen – stainless steel

Standard Finishes:

- Steel – electrogalvanized with chromate treatment.

Options:

Description	Suffix
Copper-free aluminum construction	SA



Ordering Information

Size	Cat. #
1/2"	CD1
3/4"	CD2

NEMA 4X Breather/Drain

I M2 II 2GD, E Exe I & II
(Stainless Steel & Brass only)
II 2GD, E Exe II (Nylon version)
CSA Class I, Division 2, Groups
A, B, C & D, Exe II

Enclosure Type 4X
IP66

ATEX and GENELEC Range

Applications:

For use in enclosures to provide a method to effectively drain moisture while allowing the enclosure to breathe.

Features:

- All NEMA 4X breather/drains offer:
- Castellated locknuts that allow moisture to pass between the enclosure and the locknut to the drain holes in the fitting.
 - Available in brass, stainless steel (Type 316) or 30% glass filled nylon.
 - Captive "O" ring on recess of the face of the breather/drain to optimize ingress protection.
 - ATEX and CSA Certified for worldwide market acceptance.
 - Available with metric or NPT threads.

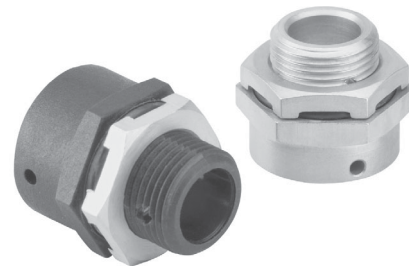

Certifications and Compliances:

- SIRA 99 ATEX 3050U
- I M2 II 2GD, E Exe I & II (Stainless Steel & Brass only)
- II 2GD, E Exe II (Nylon only)
- CSA Class I, Division 2, Groups A, B, C & D, Exe II
- Enclosure Type 4X
- IP66

Ordering Information

Entry Method	Material	Cat. #
M20	Brass	ACDPEB/M20/15
M20	Stainless Steel	ACDPES/M20/15
M20	Nylon	ACDPEN/M20/15
M25	Brass	ACDPEB/M25/15
M25	Stainless Steel	ACDPES/M25/15
M25	Nylon	ACDPEN/M25/15
1/2"	Brass	ACDPEB/050NPT/15
1/2"	Stainless Steel	ACDPES/050NPT/15
3/4"	Brass	ACDPEB/075NPT/15
3/4"	Stainless Steel	ACDPES/075NPT/15

Operating Temperature:

- -50°C to +85°C

Crouse-Hinds

by **E.T.N**

6F

6F

Industrial Fittings

Section F

Time-tested and innovative conduit fittings, cord connectors and cable glands move power where you need it simply and safely in any electrical installation.

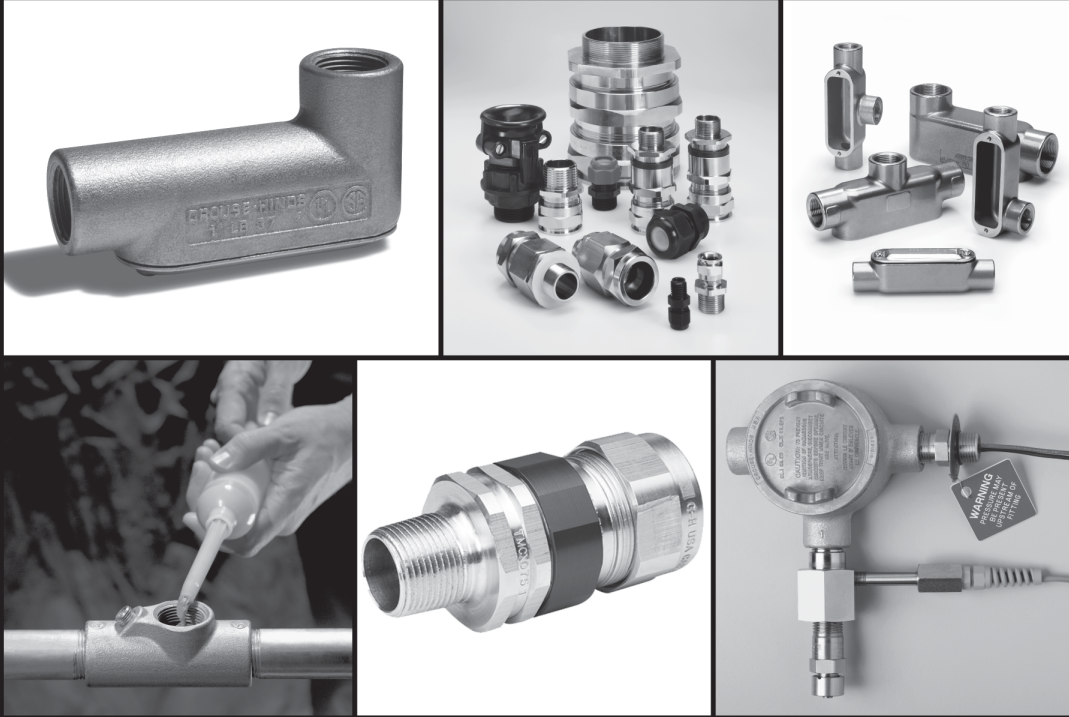

New Products in the Industrial Fittings Product Line

- Terminator™ II TMCX Cable Glands

Section

4F

F Electrical Fittings

Table of Contents

L

Section F of the Eaton's Crouse-Hinds Product Catalog lists a wide variety of conduit outlet bodies and boxes, cable fittings, unions, connectors, seals, breathers, and drains for both hazardous and non-hazardous area use. Information on applications, features, standard materials, standard finishes, options, size ranges, compliances, and accessories is presented for ease of product selection. Information relating to product families in Section F is grouped as follows:

Section 1F

Condulet® Conduit Bodies and Outlet Boxes

(for non-hazardous areas)

Conduit bodies for installation in conduit systems to act as pull outlets, make 90° bends, provide for splices, taps, mounting outlets, etc.

Form 7	Mogul	SLB
Form 8	LBD	LBY
Mark 9	LBNEC	ET
Form 5		
Series 5		
Form 7 SnapPack™		

Round cast outlet boxes and accessories for use in conjunction with threaded rigid conduit to serve as junction boxes, pull outlets, accommodate wiring devices and support lighting fixtures.

GRF	VXF
-----	-----

Section 2F

Condulet Device Boxes

(for non-hazardous areas)

For installation in conduit systems to:

- Accommodate wiring devices
- Act as pull boxes
- Provide openings for taps and splices

Provided in two box depths with a wide variety of hub configurations and sizes. Boxes can accommodate single or multiple devices.

FS	FD	Covers
----	----	--------

Section 3F

Condulet Conduit Bodies and Outlet Boxes

(for hazardous areas)

For use with rigid conduit systems:

- Act as pull and splice boxes
- Act as mounting outlets or supports for lighting fixtures
- Act as sealing fittings

CPS	ET	LBH	STL
EAB	GUA	LBY	EAJ
EKC	HTL	OE	GUR

Section 4F

Cable Glands and Cable Accessories

(for hazardous and non-hazardous areas)

Includes listings of cable and cord connectors and cable terminators for armoured and unarmoured cable and cord, and aluminum sheathed cable. Used to:

- Provide means for passing cord, cable or flexible conduit through bulkhead and into boxes and cabinets
- Form watertight seal
- Form non-slip connection or termination for flexible cord, cable or flexible conduit
- Provide grounding continuity

ADE 1F	ADE 6FC	LCC	TMC
ADE 4F	CGB	LCCF	Terminator™ II TMCX
ADE 6F	CGFP	TGC	TMCX
ADE 1FC	EBY	THRU-WALL	

Section 5F

Elbows, Couplings, Hubs, Grounding Devices, Plugs, Reducers, Service Entrance and Unions

(for hazardous and non-hazardous areas)

Includes:

- Service entrance heads
- Grounding receptacles and straps
- Unions and elbows for threaded conduit systems
- Couplings for use where allowance must be made in conduit system for difficult bends or vibration
- Reducers for connecting conduit of different dimensions
- Plugs for unused conduit openings and hubs

ECGJH	GC	LNR	UNA	UNY
ECLK	GCR	PLG	UNF	UNYL
EL	GCT	RE	UNFL	XD
F	HUBS	REC	UNL	XJG

Section 6F

Seals, Breathers and Drains

(for hazardous areas)

Includes:

- Seals used to prevent passage of gases or flames in conduit runs and from device enclosures
- Sealing/drain fittings for retrofit applications
- Breathers used to provide ventilation for enclosures
- Drains used to prevent accumulation of moisture in conduit systems and enclosures
- *Chico*® sealing compound and fiber

Seal	Seal and drain	Breather and drain
EYS	EYD	ECD
EZS	EZD	CD
EYSR	EYDX	
EYSX		
Secondary Process Sealing Fitting		
EYS Tool Kit		

Description	Page No.
Application/Selection	see page 4
Shape Selector Chart	see page 5
Conduit Bodies - Cast Iron or Aluminum	
Forms 7 & 8, Mark 9, Series 5 and Form 5	see pages 6–81
Form 7 SnapPack™	see page 9
Mogul Series	see pages 13–14
LBD Series	see page 15
LBNEC Mogul Pulling Elbows	see page 16
Covers for Cast Iron or Aluminum Conduit Bodies	
Blank	
Forms 7 & 8, Mark 9, Series 5 and Form 5	see page 8
Mogul Series	see pages 13–14
Gaskets for Cast Iron or Aluminum Conduit Bodies	
Forms 7 & 8, Mark 9, Series 5 and Form 5	see page 8
LBD Series	see page 15
Mogul Series	see pages 13–14
Conduit Bodies, Covers and Gaskets - Stainless Steel	
see pages 17–27	
Condulet® Outlet Boxes	
GRF Series	see page 19
VXF Series	see page 19
Service Entrance Elbows & Tees	
ET Tees	see page 20
LBV & SLB Elbows	see page 20

1F Condulet® Conduit Bodies and Outlet Boxes

Application and Selection



Applications:

- Conduit bodies and outlet boxes are installed at appropriate locations in threaded rigid conduit systems to:
- Act as pull outlets for conductors to be installed in a conduit system
 - Provide openings for splices and taps in conductors
 - Act as mounting outlets for luminaires and wiring devices, or as support for luminaires (with hub and fixture hanging covers)
 - Act as junction or fuse boxes when fitted with connection blocks or fuse blocks
 - Connect conduit sections and change direction of conduit runs
 - Make 90° bends in conduit runs
 - Provide access to conductors for maintenance and future system changes

Considerations for Selection:

- Shape required – determine from configuration of conduit system and intended function of conduit bodies or outlet boxes
- Size required – determine from conduit and conductor size
- Material required – determine from environmental conditions (corrosive fumes, buried in concrete, etc.)

Quick Selector Chart - Conduit Bodies

Series	Conduit Sizes	Configuration Styles	Standard Material
Form 7	½" - 4"	C, E, L, LB, LL, LR, T, TA, TB and X	Feraloy® iron or aluminum
Form 8	½" - 4"	C, LB, LL, LR, T, TB and X	Feraloy iron
Mark 9	½" - 4"	C, LB, LL, LR, T, TB and X	Copper-free aluminum
Form 5	½" - 4"	C, LB, LL, LR, T, TB and X	Durable malleable iron construction
Series 5	½" - 4"	C, LB, LL, LR and T	Corrosion-resistant copper-free aluminum construction













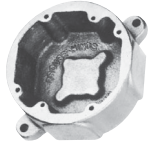









Quick Selector Chart - Conduit Outlet Boxes

Series	Conduit Sizes	Inside Dimensions		No. of Conduit Openings	Surface or Flush Mtg.	Standard Material	Finish	Covers
		Depth	Dia.					
VXF	½ and ¾	1¼	4¼	4 or 5	S	Copper-free aluminum	Epoxy enamel	When box is used as junction or pull box, install GRF covers, gaskets.
GRF	½ to 1	1⅜ to 3⅝	3 ¹¹ / ₁₆	0 to 4	S - F	Feraloy iron alloy or aluminum	Electrogalvanized and aluminum paint	Blank, hub, standard 4" octagonal box covers, wiring devices, lighting fixture hangers, gaskets.

Condulet® Conduit Bodies and Outlet Boxes

1F

Shape Selector Chart

Series	Page	Series	Page	Series	Page
C		T		GRF	
 <p>Form 7 Form 8 Mark 9 Form 5 Series 5</p>	see pages 6-12 see pages 6-12 see pages 6-12 see pages 6-12 see pages 6-12	 <p>Form 7 Form 8 Mark 9 Form 5 Series 5</p>	see pages 6-12 see pages 6-12 see pages 6-12 see pages 6-12 see pages 6-12	 <p>Outlet Box</p>	see page 19
E		TB		BT	
 <p>Form 7</p>	see pages 6-12	 <p>Form 7 Form 8 Mark 9 Form 5</p>	see pages 6-12 see pages 6-12 see pages 6-12 see pages 6-12	 <p>Mogul</p>	see pages 13-14
LB		X		LBD	
 <p>Form 7 Form 8 Mark 9 Form 5 Series 5</p>	see pages 6-12 see pages 6-12 see pages 6-12 see pages 6-12 see pages 6-12	 <p>Form 7 Form 8 Mark 9 Form 5</p>	see pages 6-12 see pages 6-12 see pages 6-12 see pages 6-12	 <p>1/2 - 1"</p>	see page 15
LL		LBNEC		LBD	
 <p>Form 7 Form 8 Mark 9 Form 5 Series 5</p>	see pages 6-12 see pages 6-12 see pages 6-12 see pages 6-12 see pages 6-12	 <p>LBNEC</p>	see page 16	 <p>1 1/4 - 6"</p>	see page 15
LR		BC		SLB	
 <p>Form 7 Form 8 Mark 9 Form 5 Series 5</p>	see pages 6-12 see pages 6-12 see pages 6-12 see pages 6-12 see pages 6-12	 <p>Mogul</p>	see pages 13-14	 <p>Service Entrance Elbows</p>	see page 20
L		BLB		LBY	
 <p>Form 7</p>	see pages 6-12	 <p>Mogul</p>	see pages 13-14	 <p>Service Entrance Elbows</p>	see page 20
TA		BUB		ET	
 <p>Form 7</p>	see pages 6-12	 <p>Mogul</p>	see pages 13-14	 <p>Service Entrance Elbows</p>	see page 20
		VXF			
		 <p>Outlet Box</p>	see page 19		

1F Condulet® Conduit Bodies - Cast Iron or Aluminum

Gasket and Covers see page 8

1F

Applications:

- Conduit outlet bodies are installed in conduit systems to:
- Act as pull outlets for conductors being installed
 - Provide openings for making splices and taps in conductors
 - Connect conduit sections
 - Provide taps for branch conduit runs
 - Make 90° bends in conduit runs
 - Provide for access to conductors for maintenance and future system changes

Features:

Conduit Outlet Bodies

- Form 7 Condulet outlet bodies approach conduit in size for neat, compact installations
- Form 8 and Mark 9 bodies provide more room for heavier conductors
- Many shapes and sizes are available for rigid threaded conduit – for complete listings see pages 6–12
- Conduit hubs have tapered threads and feature integral bushings for protection of wire insulation
- Form 7 has exclusive snaptight and wedgenut cover attachment to provide clear, unobstructed cover opening
- Built-in rollers on all Form 5 1 1/4" to 4" C and LB bodies to facilitate wire pulling
- Series 5 bodies available in optional configuration with set screws on hubs for EMT conduit (add suffix -MT to catalog number)

Gaskets

Solid gaskets:

- Are used with blank covers
- For Mark 9 and Form 5, can be converted to open type gaskets by tearing out center section along scored lines – 1/2" to 2" sizes
- For Form 7 are used with all covers

Open gaskets:

- For Form 8 – 1/2" to 4" sizes
- For Mark 9 – 2 1/2" to 4" sizes

Blank Covers

Stainless steel cover screws are standard on Form 7, Form 8, Mark 9, Series 5 and Form 5 covers.

• Form 7

Wedge nut design facilitates installation and removal. Nuts are held captive in cover. Covers can be used with or without gaskets. SNAPTIGHT™ Form 7 Covers with integral sealing gaskets are installed without the use of screws, reducing installation time and costs. Covers are reusable.

• Form 8

Two cover screws provided on all sizes to provide tight cover and gasket assembly. *Feraloy* iron alloy covers have dome shapes for added strength and extra wiring room.

• Mark 9

Self-retaining cover screws.

Certifications and Compliances:

Outlet Bodies –

- UL Standard: 514B
- Fed. Spec.: W-C-586D
- CSA Standard 22.2 No. 18
- NEMA 3R Raintight (when installed with cover and gasket)

Standard Materials:

- Form 7, Form 8 outlet bodies – *Feraloy* iron alloy
- Mark 9 outlet bodies – copper-free aluminum
- Form 5 – malleable iron
- Series 5 – die cast aluminum

Standard Finishes:

- Form 7, Form 8 outlet bodies – electrogalvanized with aluminum acrylic paint
- Mark 9 outlet bodies – natural
- Form 5 – electrogalvanized with aluminum acrylic paint
- Series 5 – aluminum acrylic paint

Options:

Description	Suffix
Form 7 body and cover only:	
Copper-free aluminum	SA
<i>Corro-free</i> ™ epoxy powder coat - external body only	S752
<i>Corro-free</i> ™ epoxy powder coat - internal and external	S753
Series 5 in an EMT version with set screws on all hubs	MT
Series 5 pre-packaged with neoprene gasket and cover	CGN



Form 7



Mark 9

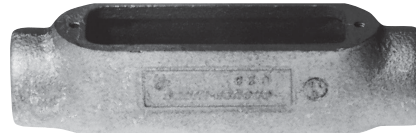

Form 8









Mogul

Condulet® Conduit Bodies - Cast Iron or Aluminum

1F

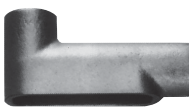
Dimensions Pgs. See pages 10–12 (Dimensions for Form 5 – see Section CP)

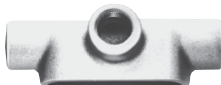
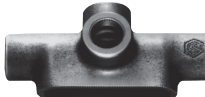
Threaded Rigid Bodies

Shape	Style	Hub Size										
		1/2	3/4	1	1 1/4	1 1/2	2	2 1/2	3	3 1/2	4	
	C											
	Form 7	C17	C27	C37	C47	C57	C67	C77	C87			
	Form 8	C18	C28	C38	C448	C58	C68	C78	C88			
	Mark 9	C19	C29	C39	C49	C59	C69	C789	C889	C989	C1089	
	Form 5	C50M	C75M	C100M	C125M*	C150M*	C200M*	C250M*	C300M*	C350M*	C400M*	
Series 5	C15	C25	C35	C45	C55	C65	C75	C85	C95*	C105*		
	E											
	Form 7	E17	E27	E37								
	L											
	Form 7	L17	L27	L37	L47	L57	L67					
Double faced – may be used as LL or LR – has 2 openings, one of which is furnished with a blank sheet steel cover												
	LB											
	Form 7	LB17	LB27	LB37	LB47	LB57	LB67	LB777	LB87	LB97	LB107	
	Form 8	LB18	LB28	LB38	LB448	LB58	LB68	LB78	LB888	LB98	LB108	
	Mark 9	LB19	LB29	LB39	LB49	LB59	LB69	LB789	LB889	LB989	LB1089	
	Form 5	LB50M	LB75M	LB100M	LB125M*	LB150M*	LB200M*	LB250M*	LB300M*	LB350M*	LB400M*	
Series 5	LB15	LB25	LB35	LB45	LB55	LB65	LB75	LB85	LB95	LB105		
	LL											
	Form 7	LL17	LL27	LL37	LL47	LL57	LL67	LL777	LL87	LL97	LL107	
	Form 8	LL18	LL28	LL38	LL448	LL58	LL68	LL78	LL888			
	Mark 9	LL19	LL29	LL39	LL49	LL59	LL69	LL789	LL889	LL989	LL1089	
	Form 5	LL50M	LL75M	LL100M	LL125M	LL150M	LL200M	LL250M	LL300M	LL350M	LL400M	
Series 5	LL15	LL25	LL35	LL45	LL55	LL65	LL75	LL85	LL95	LL105		
	LR											
	Form 7	LR17	LR27	LR37	LR47	LR57	LR67	LR777	LR87	LR97	LR107	
	Form 8	LR18	LR28	LR38	LR448	LR58	LR68	LR78	LR888			
	Mark 9	LR19	LR29	LR39	LR49	LR59	LR69	LR789	LR889	LR989	LR1089	
	Form 5	LR50M	LR75M	LR100M	LR125M	LR150M	LR200M	LR250M	LR300M	LR350M	LR400M	
Series 5	LR15	LR25	LR35	LR45	LR55	LR65	LR75	LR85	LR95	LR105		
	T											
	Form 7	T17	T27	T37	T47	T57	T67	T77	T87	T97	T107	
	Form 8	T18	T28	T38	T448	T58	T68	T78	T88			
	Mark 9	T19	T29	T39	T49	T59	T69	T789	T889	T989	T1089	
	Form 5	T50M	T75M	T100M	T125M	T150M	T200M	T250M	T300M	T350M	T400M	
Series 5	T15	T25	T35	T45	T55	T65	T75	T85	T95*	T105*		
	TA											
	Form 7	TA17	TA27	TA37	TA47	TA57	TA67					
	TB											
	Form 7	TB17	TB27	TB37	TB47	TB57	TB67					
	Form 8	TB18	TB28	TB38	TB448	TB58	TB68					
	Mark 9	TB19	TB29	TB39	TB49	TB59	TB69					
	Form 5	TB15	TB25	TB35	TB45	TB55	TB65					
Series 5	TB50M	TB75M	TB100M	TB125M	TB150M	TB200M						
	X											
	Form 7	X17	X27	X37	X47	X57	X67					
	Form 8	X18	X28	X38	X448	X58	X68					
	Mark 9	X19	X29	X39								
	Form 5	X15	X25	X35	X45	X55	X65					
Series 5	X50M	X75M	X100M	X125M	X150M	X200M						

* 1/2" - 4" Form 5 LB and C bodies are supplied with built-in rollers to facilitate wire pulling.

1F Condulet® Conduit Bodies - Cast Iron or Aluminum

Covers and Gaskets

Dimensions Pgs. See pages 10-12 (Dimensions for Form 5 - see Section CP)

1F

Blank Covers



Sheet Steel

Size	Form 7 Wedgenut Cat. #	Form 7 Snaughtight™ Covers‡ Cat. #	Form 7 Wedgenut w/Integral Gasket Cat. #	Form 8§ Cat. #	Form 8 w/Integral Gasket Cat. #	Form 5 w/Integral Gasket** Cat. #
1/2	170	170SG	170G	180	180G	K50SG
3/4	270	270SG	270G	280	280G	K75SG
1	370	370SG	370G	380	380G	K100SG
1 1/4	470	470SG	470G	480	480G	K125SG
1 1/2	570	570SG	570G	580	580G	K125SG
2	670	670SG	670G	680	680G	K200SG
2 1/2	870	870G		880		K250SG
3	870			880		K250SG
3 1/2	970	970G		980		K350SG
4	970			980		K350SG

‡Form 7 Snaughtight covers with integral sealing gasket are installed without the use of screws.

§Two cover screws on 1/2" to 2" Form 8 covers and four cover screws on 2 1/2" and larger Form 8 covers.

**For cover without integral gasket, remove G from catalog number.



Sheet Aluminum



Feraloy® Iron Alloy



Cast Aluminum

Size	Mark 9 Cat. #	Mark 9 w/Integral Gasket Cat. #	Form 7 Cat. #	Form 7 w/Integral Gasket Cat. #	Series 5 w/Integral Gasket** Cat. #	Form 7 Wedgenut Cat. #	Form 7 Wedgenut w/Integral Gasket Cat. #	Form 8§ Cat. #	Form 5‡ Cat. #	Form 7 Wedgenut Cat. #
1/2	190	190G	170 SA	170G SA	150 G	170F	170FG	180F	K50CM	170F SA
3/4	290	290G	270 SA	270G SA	250 G	270F	270FG	280F	K75CM	270F SA
1	390	390G	370 SA	370G SA	350 G	370F	370FG	380F	K100CM	370F SA
1 1/4	490	490G	470 SA	470G SA	450 G	470F	470FG	480F	K125CM	470F SA
1 1/2	590	590G	570 SA	570G SA	450 G	570F	570FG	580F	K125CM	570F SA
2	690	690G	670 SA	670G SA	650 G	670F	670FG	680F	K200CM	670F SA
2 1/2	889		870 SA		850 G	870F		880F	K250CM	870F SA
3	889		870 SA		850 G	870F		880F	K250CM	870F SA
3 1/2	989		970 SA		950 G	970F		980F	K350CM	970F SA
4	989		970 SA		950 G	970F		980F	K350CM	970F SA

‡Malleable iron covers.

§Two cover screws on 1/2" to 2" Form 8 covers and four cover screws on 2 1/2" and larger Form 8 covers.

**For cover without integral gasket, remove G from catalog number.

Solid Gaskets - Neoprene



Size	Form 7 Cat. #	Form 8* Cat. #	Mark 9† Cat. #	Form 5 Cat. #	Series 5 Cat. #
1/2	GASK571	GASK851N	GASK1941	GK50N	GASK015N
3/4	GASK572	GASK852N	GASK1942	GK75N	GASK025N
1	GASK573	GASK853N	GASK1943	GK100N	GASK035N
1 1/4	GASK574	GASK854N	GASK1944	GK125N	GASK045N
1 1/2	GASK575	GASK805N	GASK1945	GK125N	GASK045N
2	GASK576	GASK806N	GASK1946	GK200N	GASK065N
2 1/2	GASK578	GASK808N	GASK808N	GK250N	GASK085N
3	GASK578	GASK808N	GASK808N	GK250N	GASK085N
3 1/2	GASK579	GASK809N	GASK809N	GK350N	GASK095N
4	GASK579	GASK809N	GASK809N	GK350N	GASK095N

†1/2 - 1 1/4 are solid gaskets; 1 1/2 - 4 are open gaskets.

†1/2 - 2 are solid gaskets; 2 1/2 - 4 are open gaskets.

Form 7 SnapPack™ Pre-Assembled Body, Gasket and Cover

Applications:

Form 7 Condulets are installed in conduit systems to:

- Act as pull outlets for conductors being installed
- Provide an opening for making splices and taps in conductors
- Connect conduit sections
- Provide taps for branch conduit runs
- Make 90-degree bends in conduit runs
- Provide access to conductors in a conduit system for maintenance and future system changes

Features:

- All SnapPack product is individually bar coded to facilitate more efficient inventory control
- Distributors and end-users need to stock a single SKU instead of three separate component numbers – order the body, cover and gasket with one catalog number – saving transaction costs, and making product selection and merchandising fast and easy
- Form 7 conduit bodies are compact with a round back design for neat, efficient installations
- Conduit hubs have tapered threads and integral bushings for protection of wire insulation
- Many shapes and trade sizes available
- Sheet-steel wedge nut cover is provided with integral gasket. The wedge nut design facilitates installation and removal. Nuts and screws are held captive in cover
- Cover screws are stainless steel with a combination slotted and Phillips head, for easy installation and superior corrosion protection

Certifications and Compliances:

- UL Standard: 514B
- CSA Standard: C22.2 No. 18

Standard Materials:

- Body – *Feraloy*® iron alloy
- Gasket – urethane
- Cover – sheet steel
- Cover screws – stainless steel

Standard Finishes:

- *Feraloy* – electrogalvanized with aluminum acrylic paint
- Sheet steel – electrogalvanized

Ordering Information

Trade Size	Shape	Cat. #
1/2"	C	C17 CG
3/4"	C	C27 CG
1"	C	C37 CG
1 1/4"	C	C47 CG
1 1/2"	C	C57 CG
2"	C	C67 CG
1/2"	LB	LB17 CG
3/4"	LB	LB27 CG
1"	LB	LB37 CG
1 1/4"	LB	LB47 CG
1 1/2"	LB	LB57 CG
2"	LB	LB67 CG
1/2"	LL	LL17 CG
3/4"	LL	LL27 CG
1"	LL	LL37 CG
1 1/4"	LL	LL47 CG
1 1/2"	LL	LL57 CG
2"	LL	LL67 CG
1/2"	LR	LR17 CG
3/4"	LR	LR27 CG
1"	LR	LR37 CG
1 1/4"	LR	LR47 CG
1 1/2"	LR	LR57 CG
2"	LR	LR67 CG
1/2"	T	T17 CG
3/4"	T	T27 CG
1"	T	T37 CG
1 1/4"	T	T47 CG
1 1/2"	T	T57 CG
2"	T	T67 CG
1/2"	TB	TB17 CG
3/4"	TB	TB27 CG
1"	TB	TB37 CG
1 1/4"	TB	TB47 CG
1 1/2"	TB	TB57 CG
2"	TB	TB67 CG
1/2"	X	X17 CG
3/4"	X	X27 CG
1"	X	X37 CG
1 1/4"	X	X47 CG
1 1/2"	X	X57 CG
2"	X	X67 CG



Form 7 Condulets and covers are available in additional configurations, sizes and materials. For a complete listing of Form 7, Form 8 and Mark 9 conduit bodies and covers see pages 6–12.



1F Condulet® Conduit Bodies - Cast Iron or Aluminum

Dimensions (In Inches)

1F

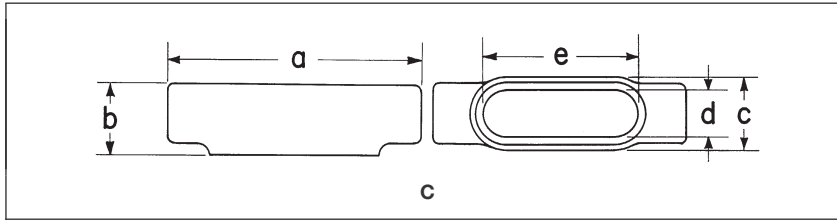

Form 7 C

Size	1/2	3/4	1	1 1/4	1 1/2	2	2 1/2	3
a	5 3/8	6	7	7 7/16	8 3/16	9 3/16	12	11 3/4
b	1 3/8	1 5/8	1 7/8	2 5/16	2 9/16	3 1/8	3 5/8	4 3/8
c	1 3/8	1 9/16	1 3/4	2 3/16	2 7/16	3	4 1/4	4 1/4
d	1 5/16	1 1/8	1 3/8	1 3/4	1 15/16	2 7/16	3 3/16	3 9/16
e	3 3/16	3 13/16	4 1/2	5	5 7/16	6 3/8	8 3/8	8 3/8

Form 8 C

Size	1/2	3/4	1	1 1/4	1 1/2	2	2 1/2	3
a	5 11/16	6 9/32	7 7/16	8 1/2	10 3/8	12 1/4	15 5/8	15 5/8
b	1 7/16	1 11/16	1 15/16	2 3/8	2 25/32	3 3/16	4 7/16	4 13/16
c	1 3/8	1 3/16	1 3/4	2 3/16	2 3/4	3 3/4	5	5
d	1	1 3/16	1 3/8	1 3/4	2 1/8	3	4 1/4	4 1/4
e	3 5/16	3 15/16	4 9/16	5 5/16	6 1/2	8 9/16	10 7/8	10 7/8

Mark 9 C

Size	1/2	3/4	1	1 1/4	1 1/2	2	2 1/2	3	3 1/2	4
a	5	5 11/16	6 19/32	7 1/2	8 3/4	10 1/2	15 5/8	15 5/8	18 3/4	18 3/4
b	1 3/8	1 5/8	1 7/8	2 1/2	2 3/4	3 7/16	4 7/16	4 13/16	5 11/16	5 15/16
c	1 3/8	1 9/16	1 3/4	2 3/16	2 1/2	3 3/16	5	5	6 1/4	6 1/4
d	1 3/16	1 3/8	1 1/2	1 15/16	2 1/4	2 7/8	4 1/4	4 1/4	5 7/16	5 7/16
e	3 3/16	3 15/16	4 9/16	5 5/16	6	8 7/16	10 7/8	10 7/8	13 7/16	13 7/16

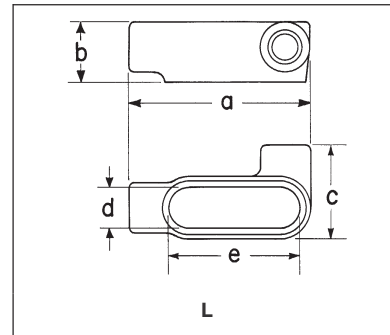
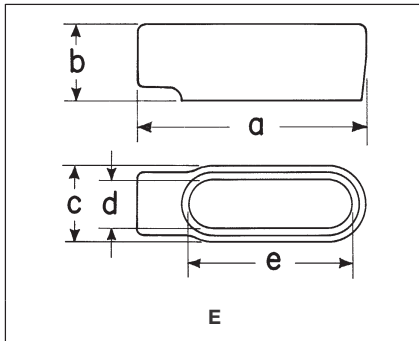

Form 7 E

Size	1/2	3/4	1
a	4 3/16	5 3/16	6
b	1 3/8	1 5/8	1 7/8
c	1 3/8	1 9/16	1 3/4
d	1 5/16	1 1/8	1 3/8
e	3 3/16	3 13/16	4 1/2

Form 7 L

Size	1/2	3/4	1	1 1/4	1 1/2	2
a	4 9/16	5 3/16	6	6 1/2	7 1/8	8 3/8
b	1 3/8	1 5/8	1 7/8	2 5/16	2 9/16	3 1/8
c	2 1/4	2 7/16	2 3/4	3 3/16	3 9/16	4 1/8
d	1 5/16	1 1/8	1 3/8	1 3/4	1 15/16	2 7/16
e	3 3/16	3 13/16	4 1/2	5	5 7/16	6 3/8

Condulet® Conduit Bodies - Cast Iron or Aluminum

1F

Dimensions (In Inches)

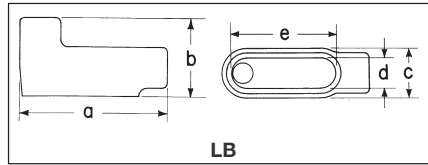

Form 7 LB

Size	1/2	3/4	1	1 1/4	1 1/2	2	2 1/2	3	3 1/2	4
a	4 9/16	5 3/16	6	6 1/2	7 1/8	8 3/8	10 1/2	10 1/2	12 11/16	12 11/16
b	2 1/4	2 1/2	2 7/8	3 9/16	3 11/16	4 1/4	5 1/8	5 7/8	6 9/16	7 1/16
c	1 3/8	1 9/16	1 3/4	2 3/16	2 7/16	3	4 1/4	4 1/4	5 1/4	5 1/4
d	1 5/16	1 1/8	1 3/8	1 3/4	1 15/16	2 7/16	3 9/16	3 9/16	4 1/2	4 1/2
e	3 3/16	3 13/16	4 1/2	5	5 7/16	6 3/8	8 3/8	8 3/8	10 1/4	10 1/4

Form 8 LB

Size	1/2	3/4	1	1 1/4	1 1/2	2	2 1/2	3	3 1/2	4
a	4 15/16	5 9/16	6 15/32	7 17/32	9 1/8	11	13 15/16	13 15/16	16 7/8	16 7/8
b	2 7/32	2 7/16	2 19/16	3 11/32	4 1/32	4 13/16	6 1/8	6 1/2	7 9/16	7 13/16
c	1 3/8	1 9/16	1 3/4	2 3/16	2 3/4	3 3/4	5	5	6 1/4	6 1/4
d	1	1 3/16	1 3/8	1 3/4	2 1/8	3	4 1/4	4 1/4	5 7/16	5 7/16
e	3 5/16	3 15/16	4 9/16	5 5/16	6 1/2	8 9/16	10 7/8	10 7/8	13 7/16	13 7/16

Mark 9 LB

Size	1/2	3/4	1	1 1/4	1 1/2	2	2 1/2	3	3 1/2	4
a	4 19/32	5 1/4	6 3/32	7 1/32	7 3/4	10 1/32	13 15/16	13 15/16	16 7/8	16 7/8
b	2 1/8	2 13/32	2 27/32	3 15/32	3 3/4	4 15/32	6 1/8	6 1/2	7 9/16	7 13/16
c	1 3/8	1 9/16	1 3/4	2 3/16	2 1/2	3 3/16	5	5	6 1/4	6 1/4
d	1 3/16	1 3/8	1 1/2	1 15/16	2 1/4	2 7/8	4 1/4	4 1/4	5 7/16	5 7/16
e	3 5/16	3 15/16	4 9/16	5 5/16	6	8 1/16	10 7/8	10 7/8	13 7/16	13 7/16



Form 7 LL & LR

Size	1/2	3/4	1	1 1/4	1 1/2	2	2 1/2	3	3 1/2	4
a	4 9/16	5 3/16	6	6 1/2	7 1/8	8 3/8	10 1/2	10 1/2	12 11/16	12 11/16
b	1 3/8	1 3/8	1 7/8	2 3/16	2 9/16	3 3/8	3 3/8	4 3/8	4 7/8	5 3/8
c	2 1/4	2 7/16	2 3/4	3 3/16	3 9/16	4 1/8	5 1/4	5 1/4	6 15/16	6 15/16
d	1 5/16	1 1/8	1 3/8	1 3/4	1 15/16	2 7/16	3 9/16	3 9/16	4 1/2	4 1/2
e	3 3/16	3 13/16	4 1/2	5	5 7/16	6 3/8	8 3/8	8 3/8	10 1/4	10 1/4

Form 8 LL & LR

Size	1/2	3/4	1	1 1/4	1 1/2	2	2 1/2	3
a	4 15/16	5 9/16	6 15/32	7 17/32	9 1/8	11	13 15/16	13 15/16
b	1 7/16	1 11/16	1 15/16	2 3/8	2 25/32	3 3/16	4 7/16	4 13/16
c	2 5/32	2 5/16	2 5/8	3 3/32	4	5	6 11/16	6 11/16
d	1	1 3/16	1 3/8	1 3/4	2 1/8	3	4 1/4	4 1/4
e	3 5/16	3 15/16	4 9/16	5 5/16	6 1/2	8 9/16	10 7/8	10 7/8

Mark 9 LL & LR

Size	1/2	3/4	1	1 1/4	1 1/2	2	2 1/2	3	3 1/2	4
a	4 19/32	5 1/4	6 3/32	7 1/32	7 3/4	10 1/32	13 15/16	13 15/16	16 7/8	16 7/8
b	1 3/8	1 3/8	1 7/8	2 1/2	2 3/4	3 7/16	4 7/16	4 3/16	5 11/16	5 15/16
c	2 1/8	2 3/8	2 5/8	3 3/32	3 7/16	4 1/8	6 11/16	6 11/16	8 1/8	8 1/8
d	1 3/16	1 3/8	1 1/2	1 15/16	2 1/4	2 7/8	4 1/4	4 1/4	5 7/16	5 7/16
e	3 5/16	3 15/16	4 9/16	5 5/16	6	8 1/16	10 7/8	10 7/8	13 7/16	13 7/16

Crouse-Hinds

by E.T.N.

1F Condulet® Conduit Bodies - Cast Iron or Aluminum

Dimensions (In Inches)

1F

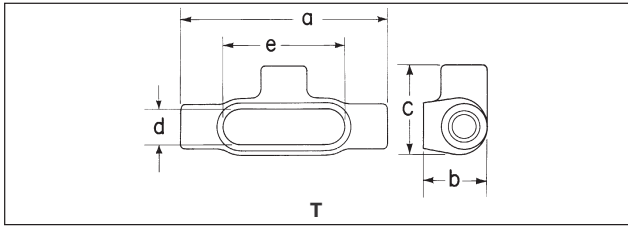

Form 7T

Size	a	b	c	d	e
1/2	5 ⁵ / ₈	1 ³ / ₄	2 ⁷ / ₁₆	1 ⁵ / ₁₆	3 ³ / ₁₆
3/4	6 ¹ / ₄	2	2 ⁵ / ₈	1 ¹ / ₈	3 ¹³ / ₁₆
1	7 ¹ / ₄	2 ¹ / ₄	3	1 ³ / ₈	4 ¹ / ₂
1 ¹ / ₄	7 ⁷ / ₁₆	2 ⁵ / ₁₆	3 ³ / ₁₆	1 ³ / ₄	5
1 ¹ / ₂	8 ³ / ₁₆	2 ⁹ / ₁₆	3 ³ / ₁₆	1 ¹⁵ / ₁₆	5 ⁷ / ₁₆
2	9 ⁹ / ₁₆	3 ¹ / ₈	4 ¹ / ₈	2 ⁷ / ₁₆	6 ³ / ₈
2 ¹ / ₂	12	3 ⁵ / ₈	5 ¹ / ₄	3 ³ / ₁₆	8 ³ / ₈
3	12 ¹ / ₁₆	4 ³ / ₈	5 ¹ / ₄	3 ³ / ₁₆	8 ³ / ₈
3 ¹ / ₂	14 ⁵ / ₁₆	4 ⁷ / ₈	6 ¹⁵ / ₁₆	4 ¹ / ₂	10 ¹ / ₄
4	14 ³ / ₁₆	5 ³ / ₈	6 ¹⁵ / ₁₆	4 ¹ / ₂	10 ¹ / ₄

Form 8T

Size	a	b	c	d	e
1/2	5 ¹¹ / ₁₆	1 ³ / ₄	2 ⁵ / ₃₂	1	3 ⁵ / ₁₆
3/4	6 ⁹ / ₃₂	2	2 ⁹ / ₁₆	1 ³ / ₁₆	3 ¹⁵ / ₁₆
1	7 ⁵ / ₁₆	2 ¹ / ₄	2 ⁵ / ₈	1 ³ / ₈	4 ⁹ / ₁₆
1 ¹ / ₄	8 ¹ / ₂	2 ⁵ / ₈	3 ⁵ / ₃₂	1 ³ / ₄	5 ⁵ / ₁₆
1 ¹ / ₂	10 ⁹ / ₁₆	2 ²⁵ / ₃₂	4	2 ¹ / ₈	6 ¹ / ₂
2	12 ¹ / ₄	3 ⁹ / ₁₆	5	3	8 ⁷ / ₁₆
2 ¹ / ₂	15 ⁵ / ₈	4 ⁷ / ₁₆	6 ¹¹ / ₁₆	4 ¹ / ₄	10 ⁷ / ₈
3	15 ⁵ / ₈	4 ¹³ / ₁₆	6 ¹¹ / ₁₆	4 ¹ / ₄	10 ⁷ / ₈

Mark 9T

Size	a	b	c	d	e
1/2	5	1 ³ / ₈	2 ¹ / ₈	1 ¹ / ₁₆	3 ⁵ / ₁₆
3/4	5 ¹¹ / ₁₆	1 ⁵ / ₈	2 ³ / ₈	1 ³ / ₈	3 ¹⁵ / ₁₆
1	6 ¹⁹ / ₃₂	1 ⁷ / ₈	2 ⁵ / ₈	1 ¹ / ₂	4 ⁹ / ₁₆
1 ¹ / ₄	7 ¹ / ₂	2 ¹ / ₂	3 ³ / ₃₂	1 ¹⁵ / ₁₆	5 ⁵ / ₁₆
1 ¹ / ₂	8 ¹ / ₄	2 ³ / ₄	3 ⁷ / ₁₆	2 ¹ / ₄	6
2	10 ¹ / ₂	3 ⁷ / ₁₆	4 ¹ / ₈	2 ⁷ / ₈	8 ¹ / ₁₆
2 ¹ / ₂	15 ⁵ / ₈	4 ⁷ / ₁₆	6 ¹¹ / ₁₆	4 ¹ / ₄	10 ⁷ / ₈
3	15 ⁵ / ₈	4 ¹³ / ₁₆	6 ¹¹ / ₁₆	4 ¹ / ₄	10 ⁷ / ₈
3 ¹ / ₂	18 ³ / ₄	5 ¹¹ / ₁₆	8 ¹ / ₈	5 ⁷ / ₁₆	13 ⁷ / ₁₆
4	18 ³ / ₄	5 ¹⁵ / ₁₆	8 ¹ / ₈	5 ⁷ / ₁₆	13 ⁷ / ₁₆

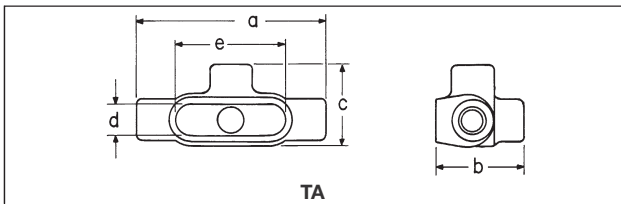

Form 7TA

Size	a	b	c	d	e
1/2	5 ⁵ / ₈	2 ⁵ / ₈	2 ⁷ / ₁₆	1 ⁵ / ₁₆	3 ³ / ₁₆
3/4	6 ¹ / ₄	2 ⁷ / ₈	2 ⁵ / ₈	1 ¹ / ₈	3 ¹³ / ₁₆
1	7 ¹ / ₄	3 ¹ / ₄	3	1 ³ / ₈	4 ¹ / ₂
1 ¹ / ₄	7 ⁷ / ₁₆	3 ⁵ / ₁₆	3 ³ / ₁₆	1 ³ / ₄	5
1 ¹ / ₂	8 ³ / ₁₆	3 ¹¹ / ₁₆	3 ³ / ₁₆	1 ¹⁵ / ₁₆	5 ⁷ / ₁₆
2	9 ⁹ / ₁₆	4 ¹ / ₄	4 ¹ / ₈	2 ⁷ / ₁₆	6 ³ / ₈

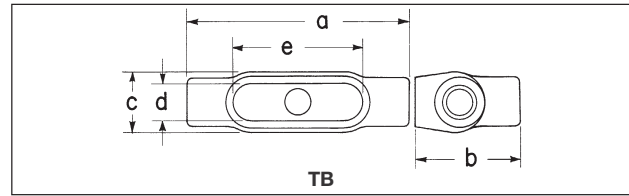

Form 7TB

Size	a	b	c	d	e
1/2	5 ⁵ / ₈	2 ⁵ / ₈	1 ⁹ / ₁₆	1 ⁵ / ₁₆	3 ³ / ₁₆
3/4	6 ¹ / ₄	2 ⁷ / ₈	1 ³ / ₄	1 ¹ / ₈	3 ¹³ / ₁₆
1	7 ¹ / ₄	3 ¹ / ₄	2	1 ³ / ₈	4 ¹ / ₂
1 ¹ / ₄	7 ⁷ / ₁₆	3 ⁵ / ₁₆	2 ³ / ₁₆	1 ³ / ₄	5
1 ¹ / ₂	8 ³ / ₁₆	5	2 ⁷ / ₁₆	1 ¹⁵ / ₁₆	5 ⁷ / ₁₆
2	9 ⁹ / ₁₆	6 ¹ / ₈	3	2 ⁷ / ₁₆	6 ³ / ₈

Form 8TB

Size	a	b	c	d	e
1/2	5 ¹¹ / ₁₆	2 ¹⁷ / ₃₂	1 ³ / ₈	1	3 ⁵ / ₁₆
3/4	6 ⁹ / ₃₂	2 ¹ / ₄	1 ⁹ / ₁₆	1 ³ / ₁₆	3 ¹⁵ / ₁₆
1	7 ⁵ / ₁₆	3 ¹ / ₈	1 ³ / ₄	1 ³ / ₈	4 ⁹ / ₁₆
1 ¹ / ₄	8 ¹ / ₂	3 ¹¹ / ₃₂	2 ³ / ₁₆	1 ³ / ₄	5 ⁵ / ₁₆
1 ¹ / ₂	10 ⁹ / ₁₆	4 ¹ / ₃₂	2 ³ / ₄	2 ¹ / ₈	6 ¹ / ₂
2	12 ¹ / ₄	4 ¹³ / ₁₆	3 ³ / ₄	3	8 ⁷ / ₁₆

Mark 9TB

Size	a	b	c	d	e
1/2	5	2 ¹ / ₈	1 ³ / ₈	1 ³ / ₁₆	3 ⁵ / ₁₆
3/4	5 ¹¹ / ₁₆	2 ¹³ / ₃₂	1 ⁹ / ₁₆	1 ³ / ₈	3 ¹⁵ / ₁₆
1	6 ¹⁹ / ₃₂	2 ²⁷ / ₃₂	1 ³ / ₄	1 ¹ / ₂	4 ⁹ / ₁₆
1 ¹ / ₄	7 ¹ / ₂	3 ¹⁵ / ₃₂	2 ³ / ₁₆	1 ¹⁵ / ₁₆	5 ⁵ / ₁₆
1 ¹ / ₂	8 ¹¹ / ₃₂	3 ⁷ / ₈	2 ¹ / ₂	2 ⁵ / ₃₂	5 ⁵ / ₈
2	10 ⁵ / ₈	4 ¹⁹ / ₃₂	3 ⁷ / ₃₂	2 ¹⁵ / ₁₆	8 ³ / ₃₂

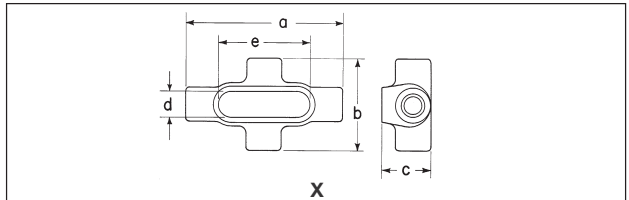

Form 7X

Size	a	b	c	d	e
1/2	5 ⁵ / ₈	3 ³ / ₁₆	1 ³ / ₄	1 ⁵ / ₁₆	3 ³ / ₁₆
3/4	6 ¹ / ₄	3 ¹ / ₂	2	1 ¹ / ₈	3 ¹³ / ₁₆
1	7 ¹ / ₄	4	2 ¹ / ₄	1 ³ / ₈	4 ¹ / ₂
1 ¹ / ₄	7 ⁷ / ₁₆	4 ¹ / ₈	2 ³ / ₁₆	1 ³ / ₄	5
1 ¹ / ₂	8 ³ / ₁₆	4 ⁵ / ₈	2 ³ / ₁₆	1 ¹⁵ / ₁₆	5 ⁷ / ₁₆
2	9 ⁹ / ₁₆	5 ³ / ₁₆	3 ¹ / ₈	2 ⁷ / ₁₆	6 ³ / ₈

Form 8X

Size	a	b	c	d	e
1/2	5 ¹¹ / ₁₆	2 ²⁹ / ₃₂	1 ³ / ₄	1	3 ⁵ / ₁₆
3/4	6 ⁹ / ₃₂	3 ¹ / ₁₆	2	1 ³ / ₁₆	3 ¹⁵ / ₁₆
1	7 ⁵ / ₁₆	3 ¹ / ₂	2 ¹ / ₄	1 ³ / ₈	4 ⁹ / ₁₆
1 ¹ / ₄	8 ¹ / ₂	4 ¹ / ₈	2 ⁵ / ₈	1 ³ / ₄	5 ⁵ / ₁₆
1 ¹ / ₂	10 ⁹ / ₁₆	5 ¹ / ₄	2 ¹⁵ / ₃₂	2 ¹ / ₈	6 ¹ / ₂
2	12 ¹ / ₄	6 ¹ / ₄	3 ⁹ / ₁₆	3	8 ⁷ / ₁₆

Mark 9X

Size	a	b	c	d	e
1/2	5 ¹¹ / ₁₆	2 ²⁹ / ₃₂	1 ³ / ₄	1	3 ⁵ / ₁₆
3/4	6 ⁹ / ₃₂	3 ¹ / ₁₆	2	1 ³ / ₁₆	3 ¹⁵ / ₁₆
1	7 ⁵ / ₁₆	3 ¹ / ₂	2 ¹ / ₄	1 ³ / ₈	4 ⁹ / ₁₆

Crouse-Hinds
by **E.T.N**

Condulet® Conduit Bodies - Cast Iron or Aluminum

1F

Mogul Bodies, Covers and Gaskets

Applications:

Mogul bodies are installed in conduit systems to:

- Act as pull outlets for conductors that are stiff, due to large size or type of insulation
- Provide the longer openings needed when pulling large conductors
- Prevent sharp bends and kinks in large conductors (protects insulation during installation)
- Provide ample openings for splices and taps
- Provide access to wiring for maintenance and future system changes

Features:

Mogul bodies have:

- Long openings
- Provision for easy bends
- Taper tapped hubs with integral bushings
- Stainless steel cover screws
- Covers are designed with integral gasket

Certifications and Complies:

- UL Standard: 514B
- Fed. Spec.: W-C-586d
- CSA Standard: C22.2 No. 18

Standard Materials:

- *Feraloy*® iron alloy

Standard Finishes:

- *Feraloy* – electrogalvanized and aluminum acrylic paint

Options:

Description
Material – copper-free aluminum
Hot dipped galvanized

Suffix
SA
HDG

BC

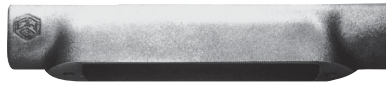

Mogul Series

Size	Cat. #
1	BC3
1¼	BC4
1½	BC5
2	BC6
2½	BC7
3	BC8
3½	BC9
4	BC10

BLB†



Mogul Series

Size	Cat. #
1	BLB3
1¼	BLB4
1½	BLB5
2	BLB6
2½	BLB7
3	BLB8
3½	BLB9
4	BLB10

† For 5" size use LBD012.
For 6" size use LBD014.

Dimensions

In Inches:

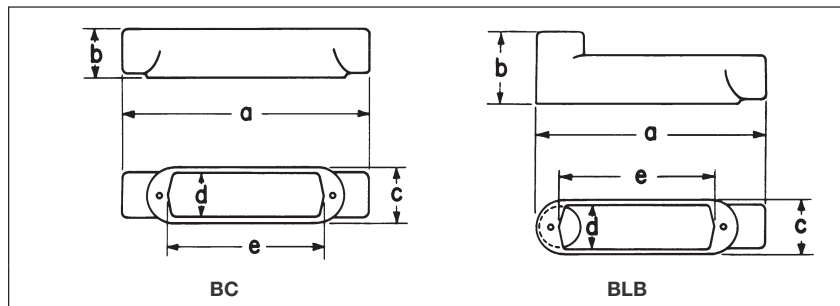

Mogul Series BC

Size	1	1¼	1½	2	2½	3	3½	4
a	9 ⁹ / ₁₆	9 ⁹ / ₁₆	13 ³ / ₄	13 ³ / ₄	18 ³ / ₈	18 ³ / ₈	23 ³ / ₄	23 ³ / ₄
b	1 ⁷ / ₈	2 ³ / ₁₆	2 ⁹ / ₁₆	3 ³ / ₈	3 ³ / ₈	4 ³ / ₈	4 ⁷ / ₈	5 ³ / ₈
c	2 ³ / ₁₆	2 ³ / ₁₆	3	3	4 ¹ / ₄	4 ¹ / ₄	5 ¹ / ₄	5 ¹ / ₄
d	1 ⁷ / ₈	1 ⁷ / ₈	2 ⁵ / ₈	2 ⁵ / ₈	3 ¹³ / ₁₆	3 ¹³ / ₁₆	4 ³ / ₄	4 ³ / ₄
e	6	6	10	10	15	15	20	20

Mogul Series BLB

Size	1	1¼	1½	2	2½	3	3½	4
a	8 ¹⁹ / ₃₂	8 ¹⁹ / ₃₂	12 ¹¹ / ₁₆	12 ¹¹ / ₁₆	16 ²⁹ / ₃₂	16 ²⁹ / ₃₂	22 ¹ / ₈	22 ¹ / ₈
b	2 ²⁷ / ₃₂	3 ⁹ / ₃₂	3 ³ / ₈	4 ³ / ₁₆	5 ²⁷ / ₃₂	5 ²⁷ / ₃₂	6 ¹ / ₂	7
c	2 ³ / ₁₆	2 ³ / ₁₆	3	3	4 ¹ / ₄	4 ¹ / ₄	5 ¹ / ₄	5 ¹ / ₄
d	1 ⁷ / ₈	1 ⁷ / ₈	2 ⁵ / ₈	2 ⁵ / ₈	3 ¹³ / ₁₆	3 ¹³ / ₁₆	4 ³ / ₄	4 ³ / ₄
e	6	6	10	10	15	15	20	20

1F Condulet® Conduit Bodies - Cast Iron or Aluminum

Mogul Bodies, Covers and Gaskets

1F

BUB



Mogul Series

Size	Cat. #
1	BUB3
1¼	BUB4
1½	BUB5
2	BUB6
2½	BUB7
3	BUB8
3½	BUB9
4	BUB10

BT

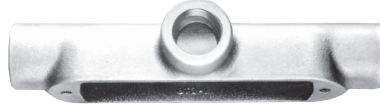

Mogul Series

Size	Cat. #
1	BT3
1¼	BT4
1½	BT5
2	BT6
2½	BT7
3	BT8
3½	BT9
4	BT10

Blank Covers



Feraloy® iron alloy (for all Mogul Series except BUBXL)

Size	With Round Neoprene Gasket Cat. #
1 or 1¼	BG48
1½ or 2	BG68
2½ or 3	BG88
3½ or 4	BG98

BUBXL with Cover & Gasket



Extra Large Mogul Series

Size	Cat. #
2	BUBXL6
3	BUBXL8

BUBXL Moguls

XL Mogul Conduit Bodies and Covers are designed to ease installation, saving time and money while maintaining the quality you have come to expect from Eaton's Crouse-Hinds.

- Larger internal volume provides additional space for bending and pulling large conductors (complies with the 6x wire bending rule)
- Rollers improve the ability to pull larger conductors and protect the insulation when the wire is being pulled, greatly reducing cut cable incidents
- Cover design takes less time to install and can be used as a solid or with the center removed for more internal volume

Dimensions In Inches:

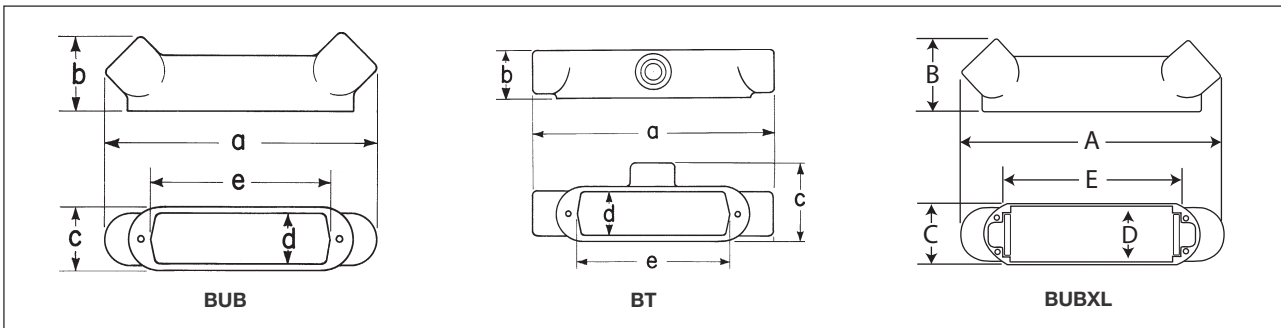

Mogul Series BUB

Size	1	1¼	1½	2	2½	3	3½	4
a	9 ⁹ / ₁₆	9 ⁹ / ₁₆	13 ³ / ₂	13 ³ / ₂	17 ³ / ₄	17 ⁷ / ₈	23 ³ / ₈	23 ³ / ₄
b	2 ¹ / ₁₆	3 ³ / ₁₆	3 ¹ / ₂	4 ¹ / ₈	4 ¹³ / ₁₆	5 ⁵ / ₈	6 ³ / ₈	6 ¹³ / ₁₆
c	2 ³ / ₁₆	2 ³ / ₁₆	3	3	4 ¹ / ₄	4 ¹ / ₄	5 ¹ / ₄	5 ¹ / ₄
d	1 ⁷ / ₈	1 ⁷ / ₈	2 ⁵ / ₈	2 ⁵ / ₈	3 ¹³ / ₁₆	3 ¹³ / ₁₆	4 ³ / ₄	4 ³ / ₄
e	6	6	10	10	15	15	20	20

Mogul Series BUBXL

Size	2	3
a	15.28	22.85
b	4.07	5.58
c	3.00	4.25
d	2.25	3.38
e	12.25	15.25

Mogul Series BT

Size	1	1¼	1½	2	2½	3	3½	4
a	9 ⁹ / ₁₆	9 ⁹ / ₁₆	13 ³ / ₄	13 ³ / ₄	18 ³ / ₈	18 ³ / ₈	23 ³ / ₄	23 ³ / ₄
b	1 ⁷ / ₈	2 ⁵ / ₁₆	2 ⁹ / ₁₆	3 ¹ / ₈	3 ⁵ / ₈	4 ³ / ₈	4 ⁷ / ₈	5 ⁵ / ₈
c	3 ³ / ₃₂	3 ⁷ / ₃₂	4 ¹ / ₁₆	4 ¹ / ₁₆	5 ¹⁹ / ₃₂	5 ²³ / ₃₂	6 ⁷ / ₈	6 ⁷ / ₈
d	1 ⁷ / ₈	1 ⁷ / ₈	2 ⁵ / ₈	2 ⁵ / ₈	3 ¹³ / ₁₆	3 ¹³ / ₁₆	4 ³ / ₄	4 ³ / ₄
e	6	6	10	10	15	15	20	20

Condulet® Conduit Bodies - Cast Iron or Aluminum

1F

LBD Mogul

Applications:

LBD bodies are installed at 90° bends in rigid conduit to:

- Act as pull outlets for conductors that are stiff due to large size or type of insulation
- Make 90° bends in conduit system, allowing straight pull in either direction
- Provide for conduit service entrance to buildings
- Provide for conductor entrance to motors
- Provide access to wiring for maintenance and future expansion

Features:

LBD bodies have:

- Cover openings on an angle permitting conductors to be pulled straight through hubs from either direction
- Domed covers to permit easy conductor bends (relieves strain on insulation)
- Cover and gasket furnished
- Taper tapped hubs with integral bushings

Certifications and Complies:

- UL Standard: 514B
- Fed. Spec.: W-C-586d
- CSA 22.2 No. 18

Standard Materials:

- Body and cover – *Feraloy*® iron alloy
- Gasket – Neoprene

Standard Finishes:

• *Feraloy* iron alloy:
1/2" to 4" sizes, electrogalvanized and aluminum acrylic paint; 5" and 6" sizes, zinc chromate primer and aluminum lacquer

- Neoprene – natural

Options:

Description

Material – All sizes, copper-free aluminum

Suffix

SA

Ordering Information



1/2 – 1"



1 1/4 – 2", 5" – 6"



2 1/2 – 4"

Size	Cat. #	Size	Cat. #	Size	Cat. #
1/2	LBD1100	1 1/4	LBD4400	3 1/2	LBD9900
3/4	LBD2200	1 1/2	LBD5500	4	LBD10900
1	LBD3300	2	LBD6600	5	LBD012
		2 1/2	LBD7700	6	LBD014
		3	LBD8800		

Replacement Gaskets for Above Sizes

Rubber

Size	Cat. #	Size	Cat. #	Size	Cat. #
1/2	GASK680R	1 1/4	GASK683R	3 1/2	GASK989R
3/4	GASK681R	1 1/2	GASK684R	4	GASK989R
1	GASK682R	2	GASK684R	5	GASK687R
		2 1/2	GASK990R	6	GASK688R
		3	GASK990R		

Replacement Cover Assembly with Hardware

Size	Cat. #	Size	Cat. #	Size	Cat. #
1/2	LBD100	1 1/4	LBD400	3	LBD800
3/4	LBD200	1 1/2	LBD600	3 1/2	LBD900
1	LBD300	2	LBD600	4	LBD900
		2 1/2	LBD800	5	LBD120
				6	LBD140

Dimensions

In Inches:

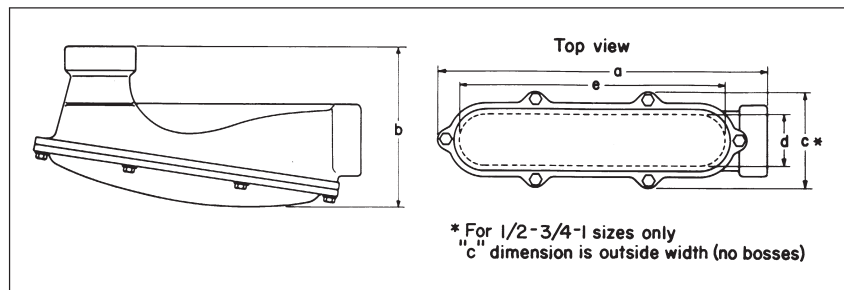

Cat. #	Size	a	b	c	d	e
LBD1100	1/2	5	2 5/16	1 5/16	1	3 11/32
LBD2200	3/4	6 1/4	2 5/8	1 9/16	1 1/4	4 17/32
LBD3300	1	6 1/4	2 15/16	1 13/16	1 1/2	4 11/32
LBD4400	1 1/4	8 5/8	4 1/4	3 1/2	1 13/16	7 7/16
LBD5500	1 1/2	12 7/16	5 7/16	4 3/8	2 5/8	10 7/8
LBD6600	2	12 7/16	5 7/16	4 3/8	2 5/8	10 7/8
LBD7700	2 1/2	19 11/16	9 9/16	5 5/8	3	15 3/4
LBD8800	3	19 11/16	9 9/16	5 5/8	3	15 3/4
LBD9900 (iron)	3 1/2	20 7/8	10 7/8	7 3/4	4 3/4	19 7/8
LBD10900 (iron)	4	20 7/8	10 7/8	7 3/4	4 3/4	19 7/8
LBD9900 (-SA)	3 1/2	27 13/16	11 7/8	7 7/8	4	24
LBD10900 (-SA)	4	27 13/16	11 7/8	7 7/8	4	24
LBD012	5	32 1/16	12 1/2	8 5/8	5 7/8	30
LBD014	6	41 1/2	15	9 3/4	7	39

1F Condulet® Conduit Bodies - Cast Iron or Aluminum

Weather Resistant

Mogul Pulling Elbows

1F

Applications:

Die cast mogul pulling elbows are installed in conduit systems to provide:

- An accessible weather resistant chamber for containing heavy duty conductors
- A chamber for containing 90° turn in large stiff conductors. Used either to change conductor direction or to enter buildings
- A pull box for pulling large conductors
- A chamber for making splices and taps
- An accessible opening to accommodate future changes of the system

Features:

- Large dome cover permits easy, straight through pull
- Dimension from centerline of back hub to bushing of end hub exceeds six times the trade diameter of the conduit
- Tapered threads provide easy assembly, tight construction
- Heavy duty machine screws for cover
- Cover is gasketed
- Smooth design and finish make handling easy and complement any construction job

Certifications and Compliances:

- UL Standard: 514A
- NEC: Article 314
- CSA C22.2 No. 18
- CEC: 22.1

Standard Materials:

- Die cast copper-free aluminum

Standard Finishes:

- Aluminum lacquer

LBNEC Furnished With Cover, Gasket and Screws

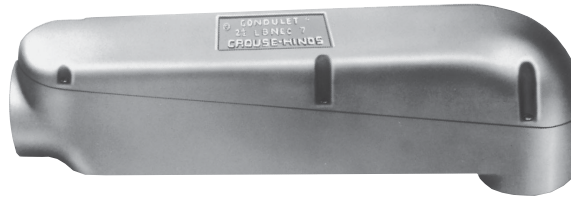

Size	Cat. #	Bending Radius
2½	LBNEC7	5¼
3	LBNEC8	5¾
3½	LBNEC9	7
4	LBNEC10	7⅝

Dimensions

In Inches:

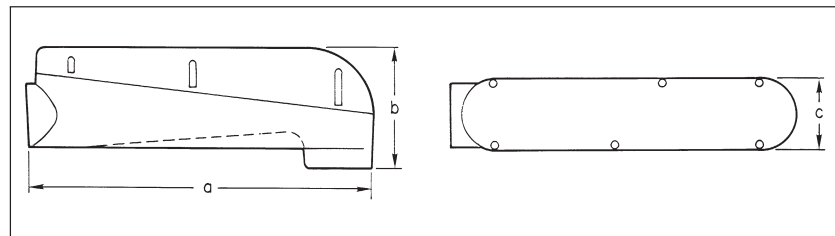

Cat. #	Size	a	b	c
LBNEC7	2½	21 ¹¹ / ₁₆	8 ⁹ / ₃₂	4½
LBNEC8	3	21 ¹¹ / ₁₆	8 ⁹ / ₃₂	4½
LBNEC9	3½	28 ¹¹ / ₁₆	9 ⁷ / ₃₂	5½
LBNEC10	4	28 ¹¹ / ₁₆	9 ⁷ / ₃₂	5½

Condulet® Conduit Outlet Bodies, Covers and Gaskets - Stainless Steel

1F

1F

Eaton's Crouse-Hinds Condulet® Stainless Steel Fittings deliver power where you need it, saving you time and money throughout the life of your facility.

Superior resistance to corrosion and heat, combined with unmatched strength, make stainless steel Condulet bodies and boxes a long-term solution for even the most extreme environments.

Applications:

Conduit outlet bodies are installed in conduit systems to:

- Act as pull outlets for conductors being installed
- Provide openings for making splices and taps in conductors
- Act as mounting outlets for lighting fixtures and wiring devices
- Connect conduit sections
- Provide taps for branch conduit runs
- Make 90° bends in conduit runs
- Provide for access to conductors for maintenance and future system changes

Features:

- Self-healing properties of stainless steel fittings help reduce the penetration of rust/corrosion and eliminate damage to the fitting
- Stainless steel fittings retain their strength in extreme heat and extreme cold conditions
- Fitting surface is easy to maintain and keep clean
- Easy cleaning capabilities make these fittings perfect for food processing and other hygienic areas where wash downs are common
- Superior strength and durability greatly reduce replacement of fittings - this will lower your total cost of ownership and increase your return on investment
- Stainless steel fittings do not require harsh environment-damaging cleaners to keep them looking like new
- Conduit hubs have tapered threads and feature integral bushing for protection of wire insulation
- Outlet bodies designed to match conduit size for neat, compact installations

Certifications and Compliances:

- UL Standard 514A
- CSA Standard C22.2 No. 18.1-04
- Raintight - when installed with cover and gasket

Standard Materials:

- Bodies - 316 stainless steel
- Covers - 316 stainless steel
- Cover Screws - 316 stainless steel
- Gasket - neoprene

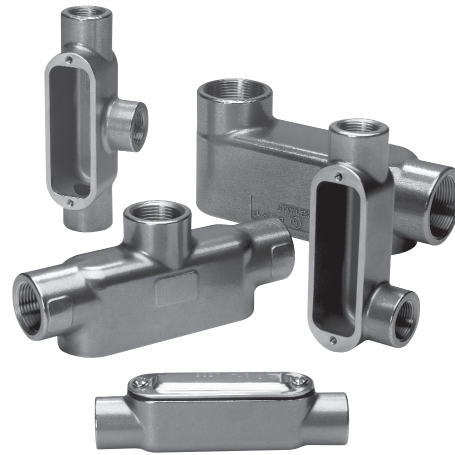

Dimension

A	Overall length
B	Overall height
C	Overall width
D	Width of opening
E	Length of opening

1F Condulet® Conduit Outlet Bodies, Covers and Gaskets - Stainless Steel

1F

Ordering Information - conduit body supplied with cover and gasket

T Conduit Body, Cover and Gasket



Catalog Number	Trade Size	A	B	C	D	E
T18SS	1/2"	5.56	1.75	1.31	1.02	3.15
T28SS	3/4"	6.61	2.00	1.63	1.27	3.92
T38SS	1"	7.53	2.31	1.78	1.42	4.61
T48SS	1 1/4"	8.75	2.50	2.25	1.83	5.50
T58SS	1 1/2"	9.37	2.75	2.47	2.03	6.12
T68SS	2"	11.50	3.38	3.13	2.50	8.00
T88SS	3"	15.00	4.63	4.34	3.71	10.25
T108SS	4"	18.25	5.44	5.50	4.87	13.00

LB Conduit Body, Cover and Gasket



Catalog Number	Trade Size	A	B	C	D	E
LB18SS	1/2"	4.86	1.35	1.31	1.02	3.15
LB28SS	3/4"	5.75	1.63	1.63	1.27	3.94
LB38SS	1"	6.48	2.00	1.78	1.42	4.55
LB48SS	1 1/4"	7.75	3.50	2.25	1.83	5.50
LB58SS	1 1/2"	8.38	2.75	2.47	2.03	6.13
LB68SS	2"	10.50	3.38	3.13	2.50	8.00
LB88SS	3"	13.50	6.13	4.34	3.71	10.25
LB108SS	4"	16.63	7.25	5.50	4.87	13.00

TB Conduit Body, Cover and Gasket

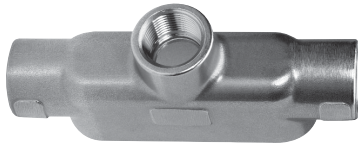

Catalog Number	Trade Size	A	B	C	D	E
TB28SS	3/4"	6.61	2.88	1.63	1.27	3.95
TB38SS	1"	7.53	3.23	1.78	1.42	4.61
TB48SS	1 1/4"	8.75	3.50	2.25	1.83	5.50
TB58SS	1 1/2"	9.37	3.75	2.47	2.03	6.12
TB68SS	2"	11.50	4.38	3.13	2.50	8.00

C Conduit Body, Cover and Gasket

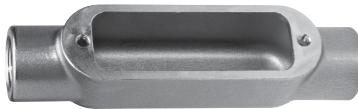

Catalog Number	Trade Size	A	B	C	D	E
C18SS	1/2"	5.56	1.38	1.31	1.02	3.15
C28SS	3/4"	6.56	1.63	1.63	1.27	3.94
C38SS	1"	7.50	2.00	1.78	1.42	4.61

LL Conduit Body, Cover and Gasket



Catalog Number	Trade Size	A	B	C	D	E
LL28SS	3/4"	5.72	1.63	1.63	1.27	3.95
LL38SS	1"	6.59	2.00	1.78	1.42	4.61

LR Conduit Body, Cover and Gasket

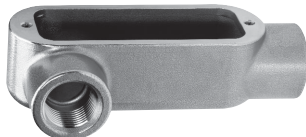

Catalog Number	Trade Size	A	B	C	D	E
LR28SS	3/4"	5.72	1.63	1.63	1.27	3.95
LR38SS	1"	6.59	2.00	1.78	1.42	4.61

Condulet® Outlet Boxes - Cast Iron or Aluminum

1F

Covers and Gaskets

Applications:

VXF and GRF cast outlet boxes are installed in threaded rigid conduit systems to:

- Act as junction boxes
- Act as pull outlets
- Accept round base wiring devices and covers intended for use on 4" outlet boxes (GRF boxes only)
- Act as ceiling or wall mounting for *Vaporgard™* lighting fixtures (VXF boxes)
- Mount enclosed and gasketed lighting fixtures: Series ARB and VGR; Series ARB fixture hangers (GRF boxes)

Features VXF:

- Compact, shallow design
- Takes GRF covers
- Multiple tapped conduit openings and pipe plugs for versatility
- 4 hubs and 3 plugs on VXF10 and VXF20
- 5 hubs and 4 plugs on VXFT10 and VXFT20

Features GRF:

- Surface mounting. Flush mounting can be obtained by nailing box to concrete form through mounting lug
- Drilled mounting lugs
- Four conduit bosses spaced 90° apart on sides and one boss on back
- Blank or drilled and tapped bodies (with 4 side bosses tapped and plugged, plus blank back boss)

Certifications and Compliances:

- UL Standard: boxes and covers – 514A
- CSA Standard: C22.2

Standard Materials:

- VXF – copper-free aluminum
- GRF – *Feraloy®* iron alloy or copper-free aluminum

Standard Finishes:

- VXF – epoxy enamel
- GRF – electrogalvanized and aluminum acrylic paint

Options:

Description
GRF bodies and covers - hot dipped galvanized

Suffix
HDG

VXF Tapped Surface With Lugs



4 Hubs, 3 Plugs

Hub Size	Cat. #
1/2	VXF10
3/4	VXF20

Surface With Lugs

Hub Size	Cat. #
1/2	VXFT10
3/4	VXFT20

GRF Blank Surface With Lugs



Inside Depth	Cat. #
1 3/8	GRF19
1 15/16	GRF29
3 1/8	GRF39

GRFX Tapped Surface With Lugs



4 Hubs, 3 Plugs Blank Back Boss

Inside Depth	Size Tap	Iron Cat. #	Aluminum Cat. #
1 3/8	1/2	GRFX119	GRF119
1 3/8	3/4	GRFX219	GRF219
2 1/16	1/2	GRFX129	GRF129
2 1/16	3/4	GRFX229	GRF229
2 1/16	1	GRFX329	GRF329
3 1/8	1/2	GRFX139	GRF139
3 1/8	3/4	GRFX239	GRF239
3 1/8	1	GRFX339	GRF339

Dimensions In Inches:

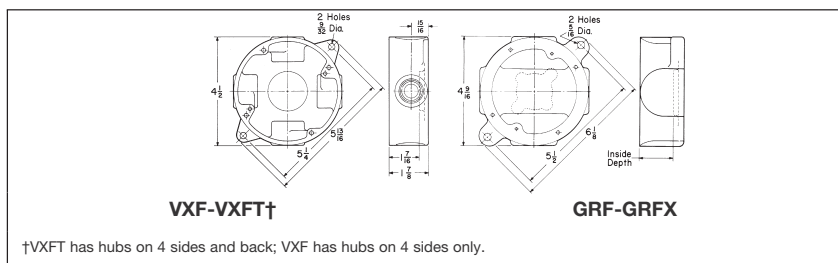

See lighting section 7L for complete listing of lighting fixtures and hangers.

GRF Blank Cover



Description	Iron Cat. #	Aluminum Cat. #
Surface	GRF10	GRF110

GRF Hub Covers



Fixture weight to 125 lbs.

Description	Size	Iron Cat. #	Aluminum Cat. #
Surface	1/2	GRF11	GRF11 SA
Surface	3/4	GRF12	GRF12 SA

GRF Gasket



Description	Cat. #
Neoprene	GASK643

1F Condulet® Service Entrance Elbows and Tees

1F

Applications:

- SLB and LBY elbows are installed in conduit systems to:
- Act as service entrance elbows between service entrance and vertical weatherhead conduit runs
 - Make 90° bends in conduit systems where space is limited
 - Act as pull outlets
 - Provide access to conductors for maintenance and future system changes

ET short radius tees are installed in conduit systems:

- In concealed conduit runs allowing single conduit stub up to outlet boxes located above or below main conduit run. Eliminates separate feed and return conduits to flush floor box or junction box

Features:

SLB elbows have:

- Compact overall size and short hubs
- Taper tapped hubs and integral bushing for standard threaded conduit
- Covers and gaskets furnished

LBY elbows have:

- Maximum volume for bends within a compact overall size
- Screw-on cover for ease of installation and removal
- Cover openings on an angle, permitting conductors to be pulled straight through either hub
- Taper tapped hubs and integral bushing for standard threaded conduit

ET short radius tees have:

- Compact size, small radius of bend for use in concealed or open conduit systems. Particularly suited for use in shallow floors or partitions
- Taper tapped hubs and integral bushing for standard threaded conduit

Certifications and Compliances:

- UL Standard: 514B
- Fed. Spec.: W-C-586a

Standard Materials:

- SLB elbows – copper-free aluminum
- LBY elbows – *Feraloy*® iron alloy
- ET tees – *Feraloy* iron alloy

Standard Finishes:

- Copper-free aluminum – natural
- *Feraloy* iron alloy – electrogalvanized and aluminum acrylic paint

Options:

Description

Finishes – LBY elbows:

Corro-free™ epoxy power coat
Material (LBY only) – copper-free aluminum construction

SLB (includes cover)



Size	Cat. #
1/2	SLB1
3/4	SLB2
1	SLB3
1 1/4	SLB4
1 1/2	SLB5
2	SLB6

Suffix

S752
SA

LBY (includes cover)



Size	Cat. #
1/2	LBY15
3/4	LBY25
1	LBY35
1 1/4	LBY45
1 1/2	LBY55

ET



Size	Cat. #
3/4 – 1/2 – 1/2	ET218
3/4 – 3/4 – 3/4	ET228
1 – 3/4 – 3/4	ET328

Largest hub shown at top of photo

Dimensions In Inches:

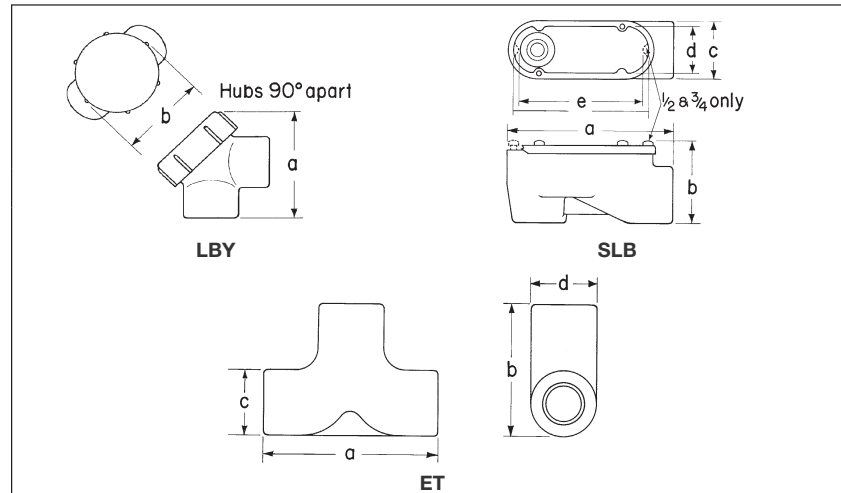

SLB

Size	1/2	3/4	1	1 1/4	1 1/2	2
a	3 1/8	3 1/2	4 1/8	5 3/8	6 25/32	7 3/4
b	1 25/32	2	19/32	2 25/32	3 1/32	3 29/32
c	1 3/16	1 3/8	1 11/16	2 3/32	2 9/8	3
d	1	1 3/16	1 15/32	1 7/8	2 5/32	2 5/8
e	2 11/16	2 15/16	3 11/32	4 3/4	6 1/32	6 31/32

LBY

Size	1/2	3/4	1	1 1/4	1 1/2
a	2 13/16	3 7/16	3 1/4	3 25/32	4 1/2
b	2	2 1/4	2 1/2	2 15/16	3 3/8

ET

Size	3/4 – 1/2 – 1/2	3/4 – 3/4 – 3/4	1 – 3/4 – 3/4
a	4	4	4
b	2 5/8	3	3
c	1 1/4	1 1/2	1 1/2
d	1 1/2	1 1/2	1 3/4



Description	Page No.
Application/Selection	see page 22
Shape Selector Charts	see page 23
Device Boxes - Cast Iron or Aluminum	
FS/FD Series	
Single gang	
Blank	see pages 31–34
Cast hubs	see pages 25–28
Multi-gang	
Blank	see pages 31–34
Cast hubs	see pages 29–30
Covers for Cast Iron or Aluminum Device Boxes	
WLR and WLG Wet Locations Covers For NEMA Configuration and GFCI Receptacles	
Blank	see page 39
Pilot light	see page 43
Push button	see page 41
Receptacle	see page 37
Switch	see page 39
Device Boxes and Covers - Stainless Steel	
FS/FD Series	see pages 35–36
Plugs and Receptacles	
DS Series	see page 42
DS/WP Series	see page 42
FSE Series	see page 46

2F Condulet® Cast Device Boxes and Covers

Application and Selection

2F

Applications:

Cast device boxes are installed in conduit and cable systems to:

- Accommodate wiring devices
- Act as pull boxes for conductors in a conduit system
- Provide openings to make splices and taps in conductors
- Provide access to conductors for maintenance and future system changes

Considerations for Selection of Device Box

Type of conduit system:

- Should be compatible with conduit or cable system.
- Boxes are standard with mounting lugs and internal green ground screw.
- Boxes are available for rigid steel, IMC; rigid aluminum; flexible conduit and cable systems.

Number of devices to be used in the box:

- Standard flush devices require one gang each

Depth:

- Two box types are available – standard (FS) and deep (FD), single through five gang.
- Standard flush wiring devices will normally fit in the FS boxes.
- Some special purpose devices of higher ratings will require the deeper box (FD).
- In addition, the need for additional wiring space will require the deep box.

Hub configuration and size:

- The layout of the conduit system dictates the conduit opening locations of the box.

The table below indicates the types of conduit and the boxes available. Drilled and tapped openings can be supplied in blank boxes to meet your requirements.

- Hub size is the same as conduit size. A variety of hub sizes are available. Where the specific hub size is not available, reducing bushings can be used.

Materials and finishes:

- The environment and the use of the box will determine the material and finish needed. Areas of the country with harsh weather and corrosive environments may require different materials and finishes for added protection.
- Standard material and finish is Feraloy® iron alloy with electrogalvanized and aluminum acrylic paint. Many items are also available in copper-free aluminum.
- Optional finishes can be obtained if environment warrants. See Options listings.

Quick Selector Chart

Box	Depth	Gang	Conduit Type	Standard Material	Standard Finish
FS	1 ¹¹ / ₁₆	1-3	Threaded rigid	Feraloy iron alloy (some are copper-free aluminum)	Feraloy iron alloy – electrogalvanized and aluminum acrylic paint. Copper-free aluminum – natural
FD	2 ¹ / ₂	1-3	Threaded rigid	Feraloy iron alloy	Feraloy iron alloy – electrogalvanized and aluminum acrylic paint
FD-SS	3.03	1	Threaded rigid	Stainless steel	Natural
FS blank bodies Drilled and tapped	1 ¹⁵ / ₁₆	1-4 1-3	Threaded rigid	Feraloy iron alloy	Feraloy iron alloy – electrogalvanized and aluminum acrylic paint
FD blank bodies Drilled & tapped	2 ¹ / ₂	1-5 1-3	Threaded rigid	Feraloy iron alloy	Feraloy iron alloy – electrogalvanized and aluminum acrylic paint

Considerations for Selection of Covers, Devices, and Accessories

Both general purpose and weatherproof, waterproof devices and covers are available. Selection will depend on individual conditions. To provide for a wide variety of applications, the following covers and devices are available:

Covers

- General use snap switch
- Pushbutton switch
- Plug and receptacle
- Blank
- Pilot light
- Receptacle

Pg.

- see pages 39–41 and 44–45
- see page 41
- see pages 37, 39, 42, and 44–46
- see pages 39 and 44–45
- see page 43
- see pages 37–39, 42, and 44–46

Devices

- Receptacle
- Pilot lights
- Wiring device

Pg.

- see page 42
- see page 43
- see page 42

Accessories

- Gaskets
- Box extensions
- Flush mtg. adapter

Pg.

- see page 43
- see page 43
- see page 43

Options:

Description

Corro-free™ epoxy powder coat

Suffix

S752

Single Gang Shape Selector Chart

Series Page

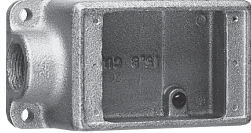

FS/FD see pages 25–26
 FS (Double face) see pages 25–28
 FS-SA see pages 25–26

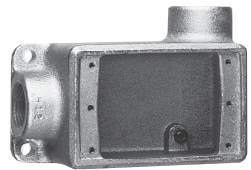

FSR/FDR see pages 25–26

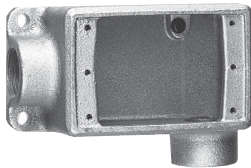

FSL/FDL see pages 25–26

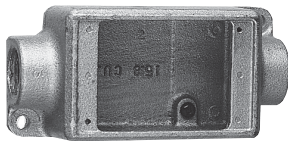

FSC see pages 25–26
 FDC see pages 25–26
 FSC (Double face) see pages 25–28
 FSC-SA see pages 25–26

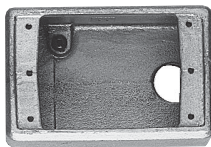

FSA/FDA see pages 25–26

Series Page

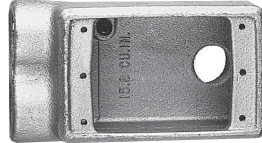

FSSA see pages 25–26

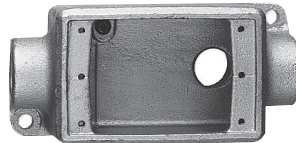

FSCA see pages 25–26

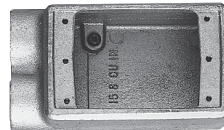

FSS see pages 25–26
 FDD see pages 25–26

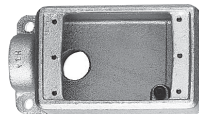

FSLA/FDLA see pages 25–26

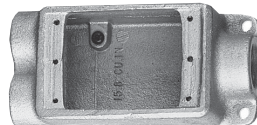

FSCC/FDCC see pages 25–26

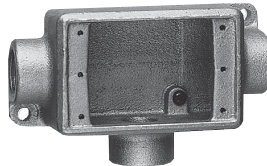

FSCT/FDCT see pages 27–28

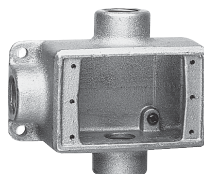

FST/FDT see pages 27–28

Series Page



FSY (With flange) see pages 27–28

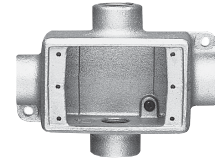

FSX/FDX see pages 27–28

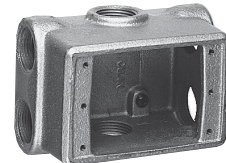

FDXC see pages 27–28

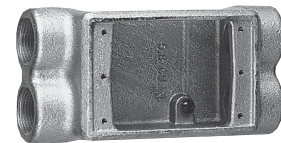

FSCD see pages 27–28



FD Stainless Steel see pages 35–36



2F

If the hub configurations required are not available, drilled and tapped openings can be provided in blank boxes per your specifications. See pages 31–34 for details.

2F Condulet® Cast Device Boxes with Hubs

Multi-Gang Shape Selector Chart

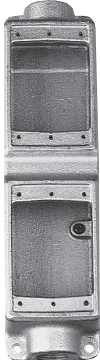
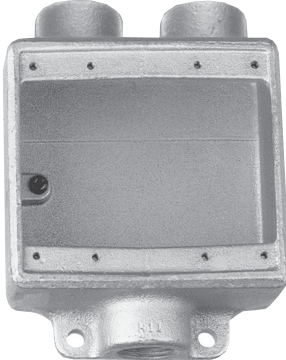
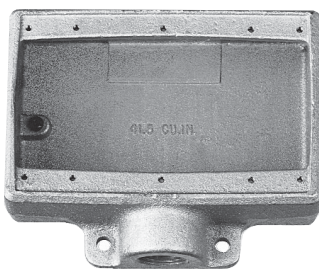
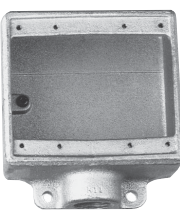
2F

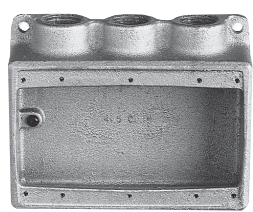
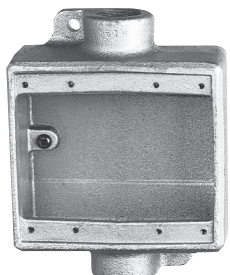
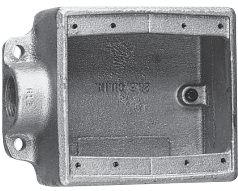
Series	Page	Series	Page	Series	Page
	see pages 29–30		see pages 29–30		see pages 29–30
FSC (Two gang tandem)		FSD (Two gang)		FS/FD (Three gang)	
	see pages 29–30		see pages 29–30		see pages 29–30
FS/FD (Two gang)		FSS/FDS (Two gang)		FSS (Three gang)	
	see pages 29–30		see pages 29–30		
FSC/FDC (Two gang)		FSE (Two gang)			

If the hub configurations required are not available, drilled and tapped openings can be provided in blank boxes per your specifications. See pages 31–34 for details.

Condulet® Single Gang Device Boxes - Cast Iron or Aluminum

Accessories
see pages 37–45

2F

With and Without Mounting Lugs for Threaded Rigid and IMC Conduit

Applications:

- Cast device boxes are installed to:
- Accommodate wiring devices
 - Act as pull boxes for conductors in a conduit system
 - Provide openings to make splices and taps in conductors
 - Provide access to conductors for maintenance and future system changes
 - Connect conduit sections
 - FSY boxes for mounting surface devices on floor or bench (used with single gang covers)

Features:

- Internal green ground screw standard on boxes
- Suitable for use in wet locations when used with gasketed covers
- Mounting lugs standard on most boxes
- Tapered threaded hubs (NPT) with integral bushing
- Available for surface mounting (with mounting lugs) or flush mounting (without mounting lugs) as listed
- Available as shallow (FS) or deep (FD) configuration. Use FD if device to be enclosed exceeds 1 5/8" in depth
- Ample wiring room provided in either FS or FD configuration
- Wide selection of surface or flush covers available in three materials (sheet steel, *Feraloy*®, aluminum)
- Covers for flush mounting extend to conceal the rough plaster line
- Available in single gang and multi-gang configurations with hubs, and as blank bodies for drilled and tapped openings

Certifications and Compliances:

- UL Standard: 514
- ANSI Standard: C33.84
- Fed. Spec.: W-C-5860
- CSA Standard: C22.2 No. 18

Standard Materials:

- *Feraloy* iron alloy or copper-free aluminum.

Standard Finishes:

- *Feraloy* – electrogalvanized and aluminum acrylic paint
- Aluminum – natural

Options:

Description	Suffix
Finishes: <i>Corro-free</i> ™ epoxy powder coat - external body	S752
<i>Corro-free</i> ™ epoxy powder coat - internal and external	S753
Hot dipped galvanized	HDG

Size Ranges:

- Hubs – 1/2" to 1"

FS & FD

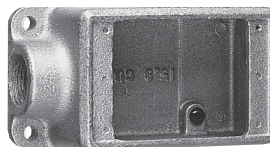

Size	Cat. #	Cat. #
1/2	FS1*	FD1†
3/4	FS2*	FD2†
1	FS3†	FD3†

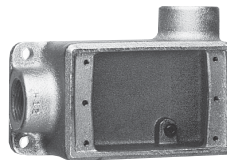

Size	Cat. #	Cat. #
1/2	FSR1	FDR1
3/4	FSR2	FDR2*†

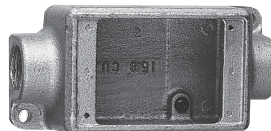

Size	Cat. #	Cat. #
1/2	FSC1*	FDC1†
3/4	FSC2*	FDC2†
1	FSC3†	FDC3†

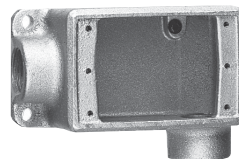

Size	Cat. #	Cat. #
1/2	FSL1	FDL1
3/4	FSL2	FDL2*†

*Available in sand cast copper-free aluminum – add suffix SCA to Cat. No.
†Available in sand cast copper-free aluminum – add suffix SA to Cat. No.

Die Cast Aluminum‡

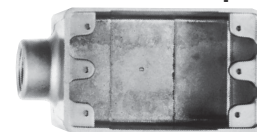

Size	Cat. #	Cat. #
1/2	FS1 SA	FSC1 SA
3/4	FS2 SA	FSC2 SA

‡Mounting lugs and ground screw are not offered with standard die cast aluminum box. For sand cast aluminum box with mounting lugs and ground screw, change "SA" in catalog number to "SCA" (Example: FS1 SCA).

2F

Condulet® Single Gang Device Boxes - Cast Iron or Aluminum

Accessories
see pages 37-45

With and Without Mounting Lugs for
Threaded Rigid and IMC Conduit

2F

FS & FD

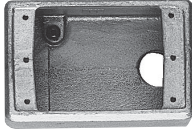

Size	Cat. #†	Cat. #†
1/2	FSA1	FDA1
3/4	FSA2	FDA2

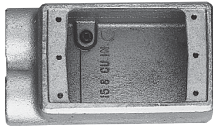

Size	Cat. #†	Cat. #†
1/2	FSS1*	FDD1
3/4	FSS2*	FDD2*
1	FSS3	FDD3

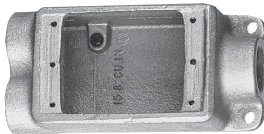

Size	Cat. #	Cat. #
1/2	FSCC1	FDCC1
3/4	FSCC2	FDCC2

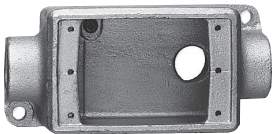

Size	Cat. #
1/2	FSCA1
3/4	FSCA2

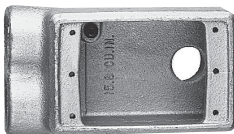

Size	Cat. #†
3/4	FSSA2

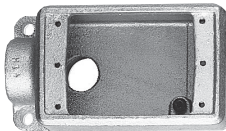

Size	Cat. #	Cat. #
1/2	FSLA1	FDLA1
3/4	FSLA2	FDLA2

*Available in copper-free aluminum; add suffix "SA".
†Mounting lugs not available.

Dimensions

In Inches:

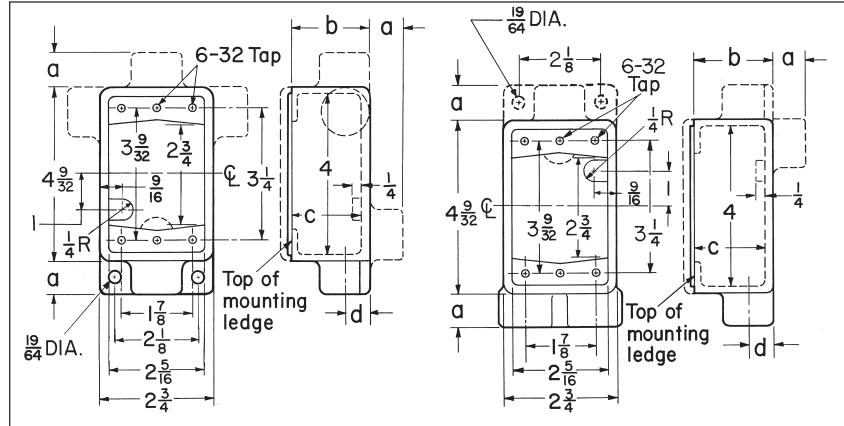

Series	Hub Size	a	b	c	d
FS	1/2	7/8	1 7/8	1 11/16	5/8
	3/4	7/8	1 7/8	1 11/16	3/4
	1	1	1 7/8	1 11/16	7/8
FD	1/2	7/8	2 11/16	2 1/2	5/8
	3/4	7/8	2 11/16	2 1/2	3/4
	1	1	2 11/16	2 1/2	7/8

Condulet® Single Gang Device Boxes - Cast Iron or Aluminum

Accessories
see pages 37-45

2F

With and Without Mounting Lugs for
Threaded Rigid and IMC Conduit

FS & FD

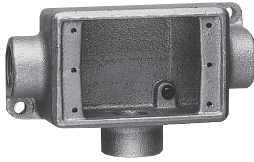

Size	Cat. #	Cat. #
1/2	FSCT1	FDCT1
3/4	FSCT2*	FDCT2*
1	FSCT3	FDCT3

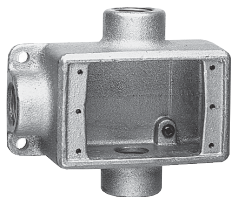

Size	Cat. #	Cat. #
1/2	FST1*	FDT1
3/4	FST2*	FDT2
1		FDT3

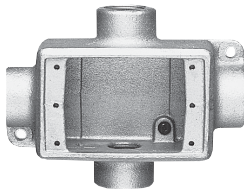

Size	Cat. #	Cat. #
1/2	FSX1	FDX1
3/4	FSX2	FDX2
1		FDX3

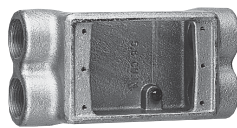

Size	Cat. #†
1/2	FSCD1
3/4	FSCD2

*Available in copper-free aluminum; add suffix "SA".
†6 Hubs - all 3/4" pipe tap.
‡ Not available with mounting lugs.

FSY

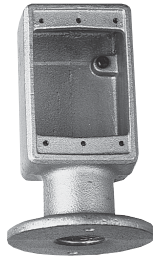

Description	Hub Size	Cat. # ‡
Single face	1	FSY311
Double face	1	FSY312

Dimensions

In Inches:

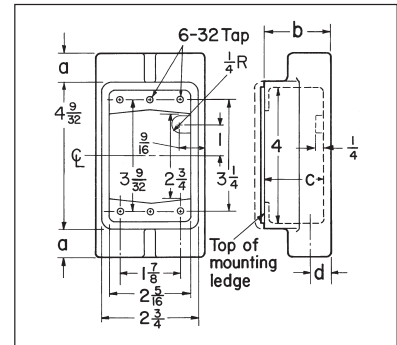
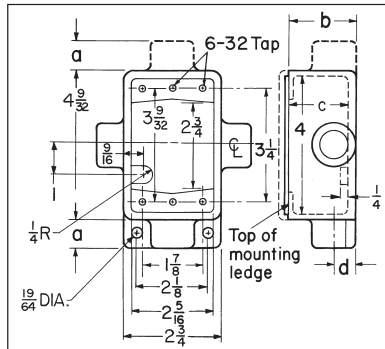

FSCT, FSX, FST, FSCD

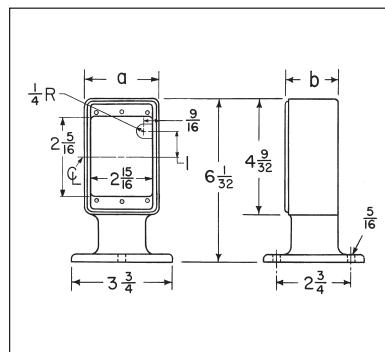

FSY

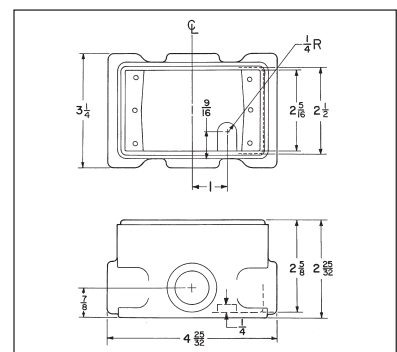

FDXC

FSCT, FSX, FST, FSCD

Series	Hub Size	a	b	c	d
FS	1/2	7/8	1 7/8	1 11/16	5/8
	3/4	7/8	1 7/8	1 11/16	3/4
	1	1	1 7/8	1 11/16	7/8

FSY

Description	Hub Size	a	b
Single gang, single face	1	2 3/4	1 15/16
Single gang, double face	1	2 3/4	3 3/8

2F Condulet® Single Gang Device Boxes - Cast Iron or Aluminum

Accessories
see pages 37–45

With and Without Mounting Lugs

2F

FS

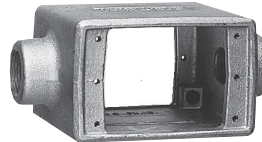

Double Face

Size	Cat. #†
1/2	FS152
3/4	FS252

Double Face

Size	Cat. #†
1/2	FSC152
3/4	FSC252

†Mounting lugs not available.

Dimensions

In Inches:

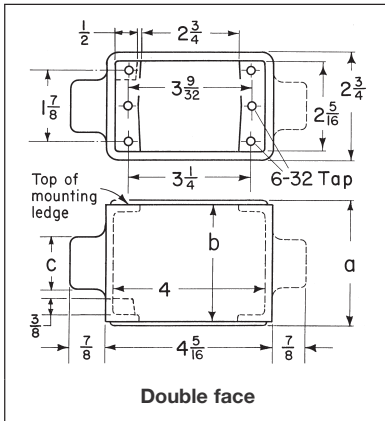

Series	Hub Size	a	b	c
FS	1/2	3 5/16	3 1/8	1 1/4
	3/4	3 11/16	3 1/2	1 1/2

Condulet® Multi-Gang Device Boxes - Cast Iron or Aluminum

Accessories
see pages 37-45

2F

With and Without Mounting Lugs for
Threaded Rigid and IMC Conduit

FS†

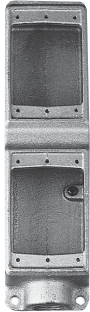

Two Gang Tandem

Size	Cat. #
1/2	FS17
3/4	FS27

FSC†



Two Gang Tandem

Size	Cat. #
1/2	FSC17
3/4	FSC27

FSE

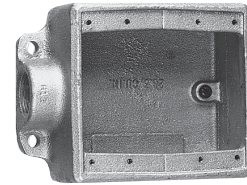

Two Gang

Size	Cat. #
3/4	FSE22

FS & FD

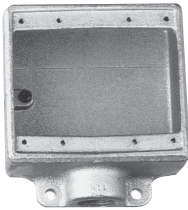

Two Gang

Size	Cat. #	Cat. #
1/2	FS12*	FD12
3/4	FS22*	FD22*
1	FS32	FD32

FSC & FDC

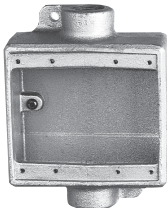

Two Gang

Size	Cat. #	Cat. #
1/2	FSC12	FDC12
3/4	FSC222	FDC222*
1	FSC32	FDC32

†Use single gang covers only.

*Available in copper-free aluminum;
add suffix "SA".

Dimensions

In Inches:

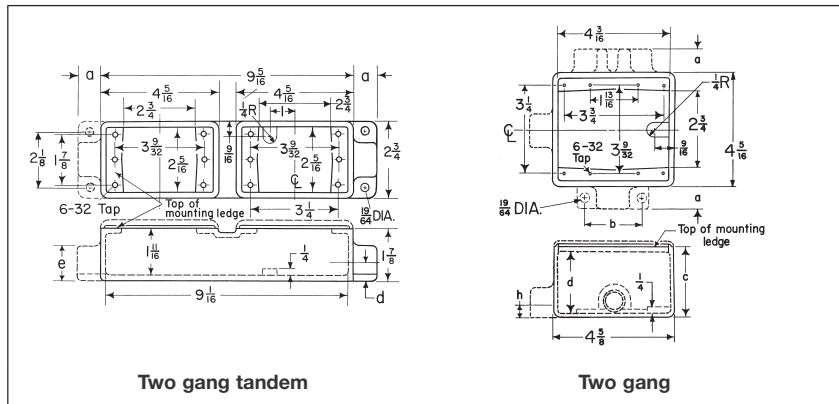

Two gang tandem

Series	Hub Size	a	b	e
FS	1/2	7/8	5/8	1 1/4
	3/4	7/8	3/4	1 1/2

Two gang

Series	Hub Size	a	b	c	d	h
FS	1/2	7/8	2 1/4	1 7/8	1 11/16	5/8
	3/4	7/8	2 1/4	1 7/8	1 11/16	3/4
	1	1	2 1/2	1 7/8	1 11/16	7/8
FD	1/2	7/8	2 1/4	2 11/16	2 1/2	5/8
	3/4	7/8	2 1/4	2 11/16	2 1/2	3/4
	1	1	2 1/2	2 11/16	2 1/2	7/8

2F

Condulet® Multi-Gang Device Boxes - Cast Iron or Aluminum

Accessories
see pages 37-45

With and Without Mounting Lugs for
Threaded Rigid and IMC Conduit

2F

FSS & FDS



Two Gang

Size	Cat. #	Cat. #
3/4	FSS222	FDS222

FSD

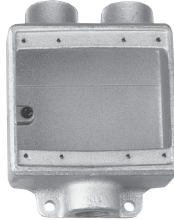

Two Gang

Size	Cat. #
3/4	FSD212*

*Hubs on 2 hub side are 1/2"

FS & FD

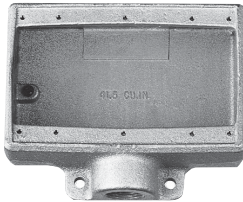

Three Gang

Size	Cat. #	Cat. #
3/4	FS23	FD23
1	FS33	

FSS

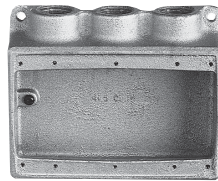

Three Gang

Size	Cat. #
3/4	FSS23

Dimensions

In Inches:

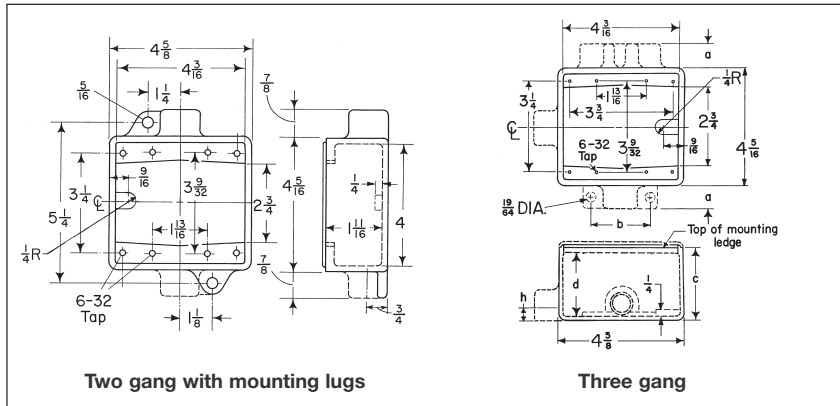

Three gang

Series	Hub Size	a	c	d
FS	3/4	7/8	1 1/8	1 11/16
	1	1	1 7/8	1 11/16
FD	3/4	7/8	2 11/16	2 1/2

Blank Bodies With Mounting Lugs for Drilling and Tapping Single Gang, Multi-Gang, Tandem

Applications:

Blank cast device boxes are used:

- Where several wiring devices are to be grouped together
- To assemble special combinations of wiring devices
- Where special arrangements of conduit hubs or entrances are required

Features:

- Available in shallow (FS) or deep (FD) configurations.
- FS/FD bodies have thick walls for drilling and tapping conduit entrances.
- Internal green ground screw standard on boxes.
- Available in single, two, three, four and five gang and two gang tandem bodies.
- Cast mounting lugs at diagonally opposite corners.
- For a wide selection of standard surface or flush covers see pages 37–45.

Certifications and Compliances:

- UL Standard: 514A
- CSA Standard: C22.2 No. 18

Standard Materials:

- *Feraloy* iron alloy

Standard Finishes:

- *Feraloy* – electrogalvanized and aluminum acrylic paint



FS019, FD019 single gang



FS062, FD062 two gang

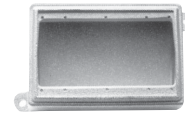

FS063, FD063 three gang

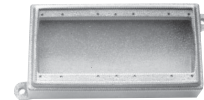

FS094, FD094 four gang

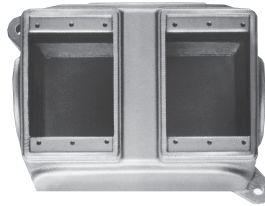

FS029, FD029 two gang

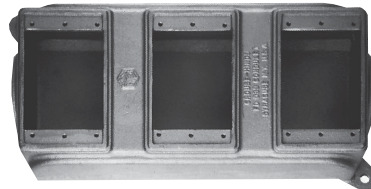

FS039, FD039 three gang



FS097, FD097 two gang tandem

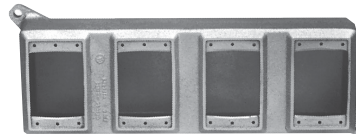

FD04 four gang



FD05 five gang

Ordering Information:

Description	Shallow Cat. #	Deep Cat. #
Single gang	FS019	FD019*
Two gang	FS029	FD029*
Three gang	FS039	FD039*
Four gang		FD04
Five gang		FD05
Two gang (takes one two gang cover)	FS062	FD062
Three gang (takes one three gang cover)	FS063	FD063
Four gang (takes one four gang cover)	FS094	FD094
Two gang tandem	FS097	FD097

*Available in copper-free aluminum. To order add suffix SA to Cat. No.

2F Condulet® Blank Device Boxes - Cast Iron

Blank Bodies for Drilling and Tapping Ordering Information

2F

Ordering Information:

To order one of the blank bodies with drilled and tapped holes listed on see pages 31-33, proceed as follows:

Step 1

Select the required box.

Step 2

Select the arrangement that meets the requirements from Table 1.

Step 3

Determine the maximum size and spacing of conduit openings from Table 2.

Step 4

Substitute the appropriate symbol from Table 4 for each conduit entrance, using "0" (zero) for those locations on arrangement where an entrance is not required.

Example:

Step 1 – box required FS062

Step 2 – arrangement 1

Step 3 – conduit entrances – 1/2" at "a", none at "b"; 1" at "c" and "d"; none at "e" and "f".

Step 4 – symbols are substituted and written in alphabetical order starting with location "a". For this example A0CC00.

Complete Cat. No. is made up of three parts:

Part 1 – box number;

Part 2 – arrangement number;

Part 3 – symbols for conduit entrances.

For this example:

FS062-1-A0CC00.

Table 1/Drilling and Tapping Arrangements*

Two, Three, Four and Five Gang

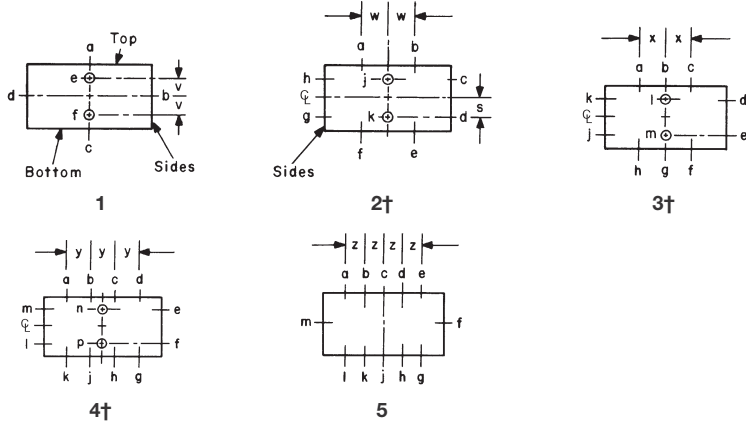

*Drilling and tapping arrangements other than those in Table 1 are available. Consult Eaton's Crouse-Hinds.
†If only one conduit entry is specified or permitted (see Table 2) on a side wall that conduit entry will be centered on the wall.

Single Gang Only (FS or FD019)

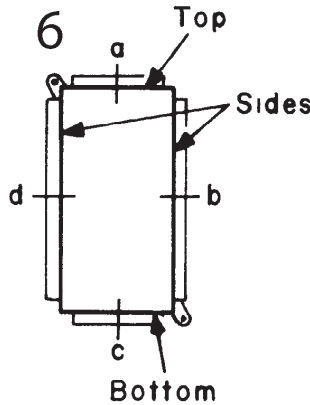

Two Gang Tandem (FS or FD097)

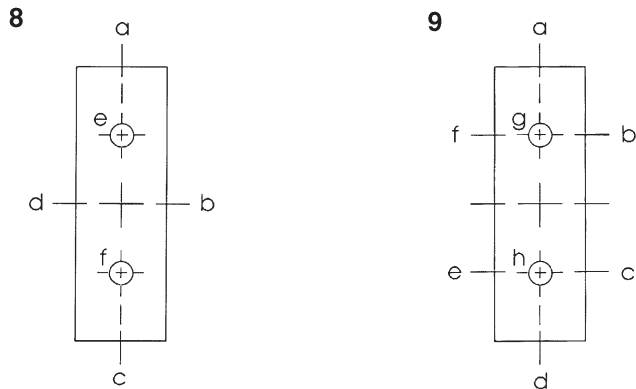

Blank Bodies for Drilling and Tapping Single-Gang, Multi-Gang, Tandem

2F

Table 2/Maximum Number, Size and Spacing of Conduit Openings

Cat. #	Maximum Conduit Opening Size													
	Top and Bottom					Sides		Back	Spacings					
	1	2	3	4	5	1	2	2	s	v	w	x	y	z
FS019	1					1								
FD019*	1½					1½								
FS029	1	1	1	¾		1					1⅞	1⅞	1⅝	
FD029*	1½	1½	1	¾		1½					1⅞	1⅞	1⅝	
FS039	1	1	1	1	1	1					3¾	3¾	2½	1⅞
FD039*	1½	1½	1½	1½	1	1½					3¾	3¾	2½	1⅞
FD04	1½	1½	1½	1½		1½	1	1		1⅜	1⅞	3¾	3¾	
FD05	1½	1½	1½	1½	1½	1½	1	1		1⅜	3¾	3¾	3¾	3¾
FS062	1	1	¾			1	1	1		1¼	29/32	1⅝		
FD062	1½	1¼	¾			1½	1	1¼	1	1	1	1⅝		
FS063	1	1	1	¾		1	1	1		1¼	1⅜	1⅜	1⅝	
FD063	1½	1¼	1	¾		1½	1	1¼	1	1	1⅜	2	1⅞	
FS094	1	1	1	1	¾	1	1	1		1¼	1⅜	1⅜	1⅜	1⅞
FD094	1½	1½	1½	1	¾	1½	1	1		1⅞	1½	2⅝	1⅜	1⅞
FS097	1	1½				1	1	1½		1⅝	¾			
FD097	1½	1½				1½	1½	1½		1⅝	¾			

Table 3/Distance From Mounting Surface to Centerline of Conduit Opening ("u")

Cat. #	u
FS019	29/32
FD019*	1⅜
FS029	29/32
FD029*	1⅜
FS039	31/32
FD039*	1⅜
FD04	1⅞
FD05	1⅞
FS062	1⅜
FD062	1⅞
FS063	1⅜
FD063	1⅞
FS094	1⅜
FD094	1⅞
FS097	1⅜
FD097	1⅞

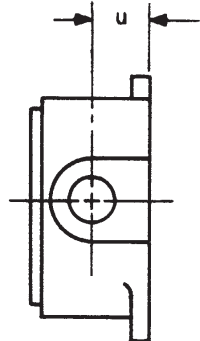

Table 4/Symbols for Openings

Conduit Size	Symbol
½	A
¾	B
1	C
1¼	E
1½	F
None	0

*Available in copper-free aluminum. To order add suffix SA to Cat. No.

2F Condulet® Cast Device Boxes

Blank Bodies for Drilling and Tapping
Single-Gang, Multi-Gang, Tandem
Dimensions (In Inches)

2F

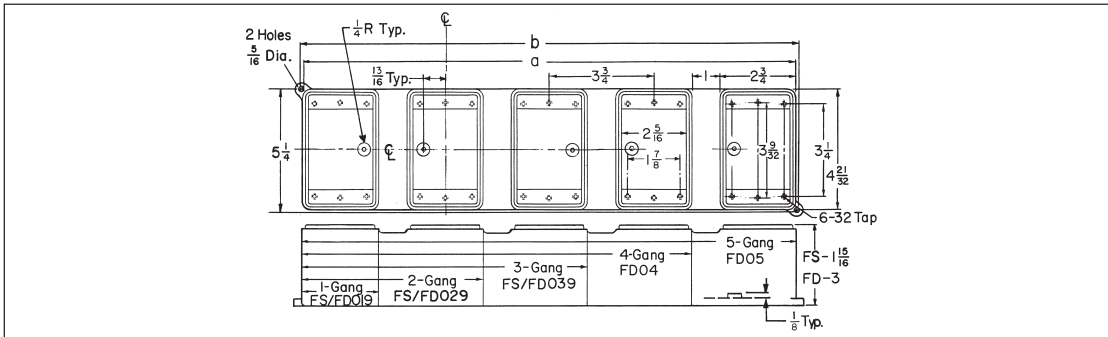

Cat. #	a	b
FS/FD019	3 1/4	3 1/4
FS/FD029	7	7
FS/FD039	10 3/4	10 3/4
FD04	14 3/8	15
FD05	18 1/8	18 3/4

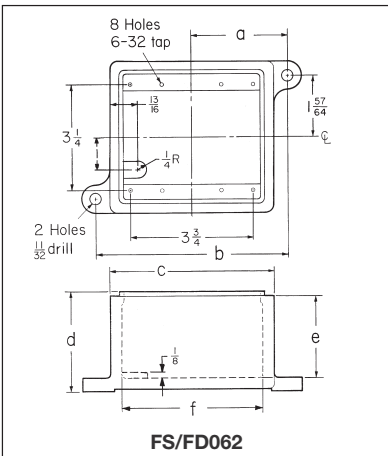

Cat. #	a	b	c	d	e	f
FS062	2 7/8	5 3/4	5	2 3/16	1 1/2	4 3/8
FD062	2 15/16	5 1/8	5 1/16	3 1/16	2 1/2	4 1/16

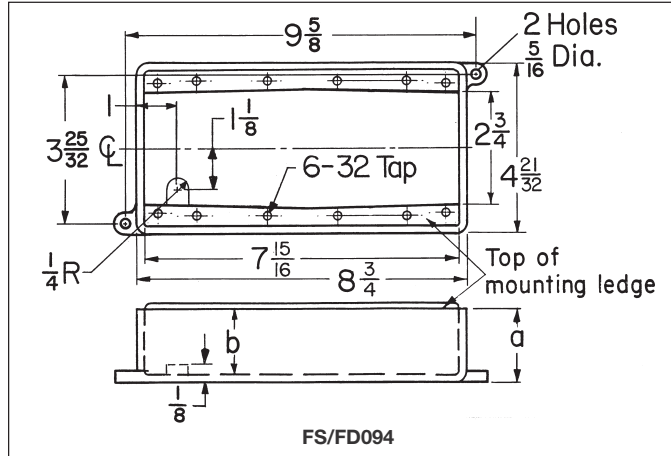

Cat. #	a	b
FS094	2 7/16	1 45/64
FD094	3	2 1/2

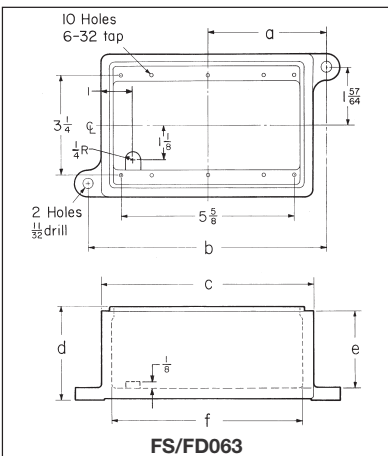

Cat. #	a	b	c	d	e	f
FS063	3 13/16	7 7/8	6 7/8	2 3/16	1 1/2	6 1/4
FD063	3 7/8	7 1/4	7 1/16	3 1/32	2 1/2	6 3/16

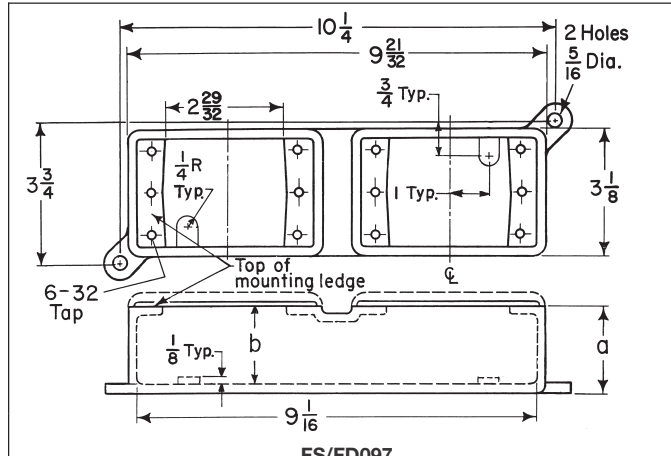

Cat. #	a	b
FS097	2 1/32	1 1/2
FD097	2 27/32	2 1/16

Condulet® Stainless Steel Conduit Device Boxes, Covers and Gaskets

2F

2F

Eaton's Crouse-Hinds Condulet® Stainless Steel Device Boxes deliver power where you need it, saving you time and money throughout the life of your facility.

Superior resistance to corrosion and heat, combined with unmatched strength, make stainless steel Condulet bodies and boxes a long-term solution for even the most extreme environments.

Applications:

Cast device boxes are installed in conduit systems to:

- Accommodate wiring devices
- Act as pull boxes for conductors in a conduit system
- Provide openings to make splices and taps in conductors
- Provide access to conductors for maintenance and future system changes
- Connect conduit systems

Features:

- Self-healing properties of stainless steel fittings help reduce the penetration of rust/corrosion and eliminate damage to the fitting
- Stainless steel fittings retain their strength in extreme heat and extreme cold conditions
- Fitting surface is easy to maintain and keep clean
- Easy cleaning capabilities make these fittings perfect for food processing and other hygienic areas where wash downs are common
- Superior strength and durability greatly reduce replacement of fittings - this will lower your total cost of ownership and increase your return on investment
- Stainless steel fittings do not require harsh environment-damaging cleaners to keep them looking like new
- Internal green grounding screw - standard
- Tapered threads for protection of wire insulation
- Wide selection of covers available
- Single or double conduit entry
- Ample wiring room provided for easy installations

Certifications and Compliances:

- UL Standard 514A
- CSA Standard C22.2 No. 18.1-04
- Raintight - when installed with cover and gasket

Standard Materials:

- Bodies - 316 stainless steel
- Covers - 316 stainless steel
- Cover Screws - 316 stainless steel
- Gasket - neoprene



Dimension

A	Length of box
B	Overall length (including hubs)
C	Width of box
D	Overall width (including hubs)
E	Height of box
F	Overall height (including hubs)

2F Condulet® Stainless Steel Conduit Device Boxes, Covers and Gaskets

The Ultimate in Corrosion Resistance and Durability

2F

Ordering Information

FD Device Body

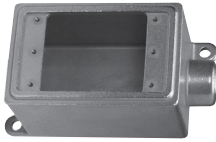

Catalog Number	Trade Size	A	B	C	D	E	F
FD2SS	3/4"	4.63	5.41	2.94	2.94	3.03	3.03

FDC Device Body

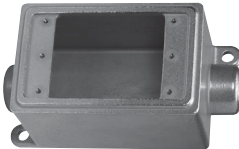

Catalog Number	Trade Size	A	B	C	D	E	F
FDC2SS	3/4"	4.63	6.19	2.94	2.94	3.03	3.03

FDS Device Body



Catalog Number	Trade Size	A	B	C	D	E	F
FDS2SS	3/4"	4.63	5.41	2.94	2.94	3.03	3.03

FDA Device Body



Catalog Number	Trade Size	A	B	C	D	E	F
FDA2SS	3/4"	4.63	4.63	2.94	2.94	3.03	3.80

FDX Device Body



Catalog Number	Trade Size	A	B	C	D	E	F
FDX2SS	3/4"	4.63	6.19	2.94	4.50	3.03	3.03

Ordering Information - Device Box Cover and Gasket

Blank Cover

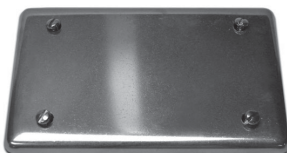

Catalog Number
DS7000BC

Blank Formed Cover



Catalog Number
DS7000BF

Switch Formed Cover



Catalog Number
DS7000SF

Receptacle Formed Cover



Catalog Number
DS7000RF

Covers for Cast Iron or Aluminum Device Boxes

WLRS and WLG Wet Location Covers

For NEMA Configuration Receptacle Interiors and GFCI Receptacles

Applications:

WLRS, WLRD and WLG series wiring device covers are designed to meet the total NEC Code requirements for wet locations. WLRS, WLRD and WLG series covers are suitable for use in wet and damp locations:

- Wherever portable equipment is required
- As general purpose utility receptacle covers
- For industrial, commercial or residential use
- In areas where electrical requirements do not exceed medium duty ratings
- To mount FS and FD single-gang or multi-gang boxes having individual cover openings (see Sect. 2F for listings)
- To mount on most flush device boxes (see Accessories)

Features:

WLRS, WLRD and WLG covers:

- Self-closing spring door assures protection of wiring device at all times, in wet and damp locations
- One piece EPDM gasket provides environmental protection of wiring device at all times
- EPDM gasketing material offers excellent resistance to ozone, weather and temperature extremes of -50°F to 260°F
- Die cast, copper-free aluminum construction with aluminum lacquer finish provides maximum corrosion resistance
- Positive ground path ensured for all exposed metal parts

NEMA configuration receptacle interiors:

- Comply with NEMA Standards WD-1 and WD-5
- Grounded through an extra contact in all types except 3-phase applications; self grounded in duplex variety
- Back and side wired
- Offered in single and duplex configurations for use with standard plugs
- Specification grade

Certifications and Compliances:

- ANSI/UL Standard 514A
- NEC Code 410-57
- OSHA Standards, Subpart "S"
- NEMA Standards WD-1, 1974 (Straight Blade) and WD-5, 1972 (Locking Type)

Standard Materials:

- WLRS, WLRD and WLG face plate and cover – die cast copper-free aluminum
- Cover hinge spring – stainless steel
- Cover screws – corrosion resistant metal
- Gasket – ethylene propylene rubber (EPDM)

Standard Finishes:

- Copper-free aluminum – aluminum lacquer

Electrical Rating Ranges:

- 15 amperes; 125, 250, or 277 volts
- 20 and 30 amperes; 125, 250, 277, 480, 600, 125 / 250, 208 / 120, 480 / 277 or 600 / 347 volts

Accessories:

- Flush mounting adapter – WLRA-1 required for mounting on device boxes. (Order separately)



Typical installation

Spring Door Covers – with Gasket*

For NEMA Configuration Round Receptacles

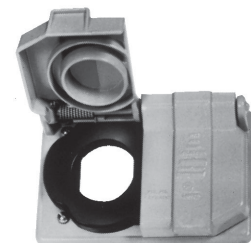

Single cover Cat. #	Diameter	Duplex cover Cat. #	Diameter
WLRS1	1 3/8"	WLRD1	1 3/8"
WLRS2	1 1/2"		

*Patent Number 4,058,358
†Horizontal mount only.

Spring Door Covers – with Gasket*

For GFCI Receptacles in Wet Locations



Horizontal Mount
for flush
device boxes
Cat. #

WLG F

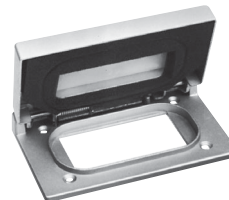

Horizontal Mount
for FS and FD
device boxes
Cat. #

WLG F S



Vertical Mount
for FS and FD
device boxes
Cat. #

WLG F S V

Covers for Cast Iron or Aluminum Device Boxes WLRS and WLG Wet Location Covers

For NEMA Configuration Receptacle Interiors and GFCI Receptacles

2F

Ordering Information - Covers with and without NEMA Configuration Receptacles For Non-Locking Blade Plugs

Type	Volts	NEMA Configuration	Complete Cover with Receptacle Assy. Cat. #	Spring Door Cover & Gasket Only Cat. #*
Single Device				
2-Pole 3-Wire Grounding 15 Amp	125V	5-15R	WLRS 5 15	WLRS1
2-Pole 3-Wire Grounding 20 Amp	250V	6-15R	WLRS 6 15	WLRS1
2-Pole 3-Wire Grounding 15 Amp	125V	5-20R	WLRS 5 20	WLRS1
2-Pole 3-Wire Grounding 20 Amp	250V	6-20R	WLRS 6 20	WLRS1

Type	Volts	NEMA Configuration	Complete Cover with Receptacle Assy. Cat. #	Spring Door Cover & Gasket Only Cat. #*
Duplex Device				
2-Pole 3-Wire Grounding 15 Amp	125V	5-15R	WLRD 5 15	WLRD1
2-Pole 3-Wire Grounding 20 Amp	250V	6-15R	WLRD 6 15	WLRD1
2-Pole 3-Wire Grounding 15 Amp	125V	5-20R	WLRD 5 20	WLRD1
2-Pole 3-Wire Grounding 20 Amp	250V	6-20R	WLRD 6 20	WLRD1

Ordering Information - Covers with and without NEMA Configuration Receptacles For Locking Blade Plugs

Type	Volts	NEMA Configuration	Complete Cover with Receptacle Assy. Cat. #	Spring Door Cover & Gasket Only Cat. #*
Single Device				
2-Pole 3-Wire Grounding 15 Amp	125V	L5-15R	WLRS L5 15	WLRS1
2-Pole 3-Wire Grounding 20 Amp	250V	L6-15R	WLRS L6 15	WLRS1
2-Pole 3-Wire Grounding 15 Amp	125V	L5-20R	WLRS L5 20	WLRS2
2-Pole 3-Wire Grounding 20 Amp	250V	L6-20R	WLRS L6 20	WLRS2

Type	Volts	NEMA Configuration	Complete Cover with Receptacle Assy. Cat. #	Spring Door Cover & Gasket Only Cat. #*
Duplex Device				
2-Pole 3-Wire Grounding 15 Amp	125V	L5-15R	WLRD L5 15	WLRD1

*Must be used with a wet locations rated wiring device.

Dimensions In Inches:

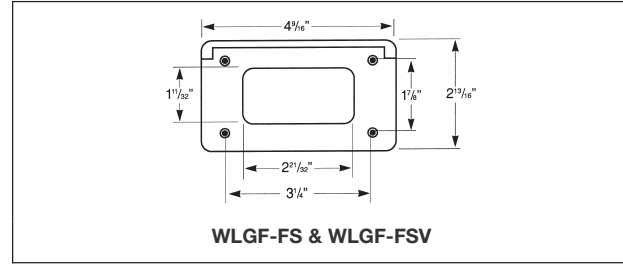
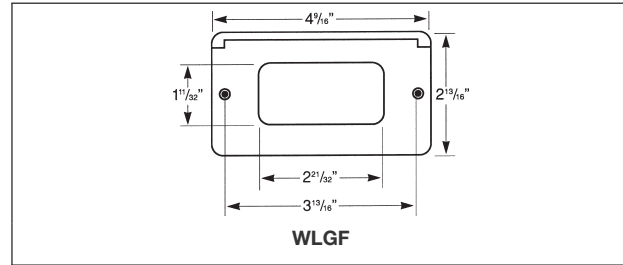
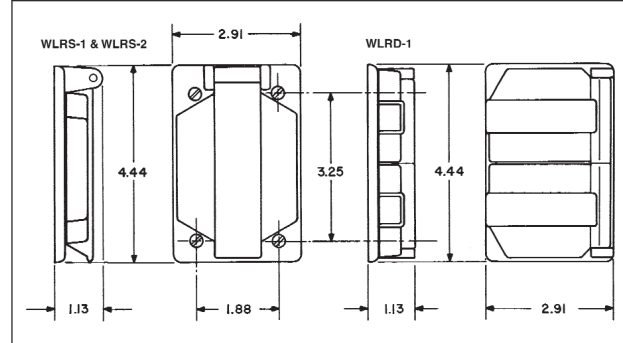

Single Gang

Ordering Information



Blank cover for enclosing splices and taps where device not used.

Description	Material	Cat. #
Surface	Sheet aluminum	DS100
Flush	Sheet steel	DSS100



Blank cover with gasket for enclosing splices and taps where device not used.

Description	Material	Cat. #
Surface or Flush	Cast aluminum	DS100G



DS21

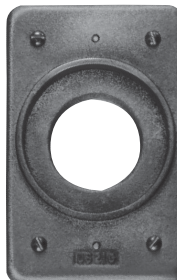

DS21G

For standard and 3-pole, 2-wire grounding type round flush receptacles. Opening diameter 1⁷/₁₆".

Description	Material	Cat. #
Surface	Sheet steel	DS21
Surface	Sheet aluminum	DS21 SA
Surface or flush	<i>Feraloy</i> [®] iron alloy with gasket	DS21G



For GFI receptacles.

Description	Material	Cat. #
Surface	Sheet steel	DS23 GFI



For flush plug receptacle requiring 1¹/₈" opening diameter.

Description	Material	Cat. #
Surface	Sheet steel	DS35

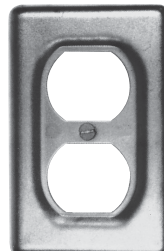

For duplex convenience receptacles.

Description	Material	Cat. #
Surface	Sheet steel	DS23
Surface	Sheet aluminum	DS23 SA
Flush	Sheet steel	DSS23



For standard and 3-pole, 2-wire grounding type duplex convenience receptacles. Gasket included.

Description	Material	Cat. #
Surface or flush	<i>Feraloy</i> [®] iron alloy	DS23G



For square handle general use snap or toggle switches – unguarded.

Description	Material	Cat. #
Surface	Sheet steel	DS32
Surface	Sheet aluminum	DS32 SA

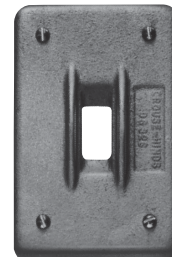

For square handle general use snap or toggle switches – guarded.

Description	Material	Cat. #
Surface or flush	<i>Feraloy</i> [®] iron alloy with gasket	DS32G
Surface	Sheet steel	DS52

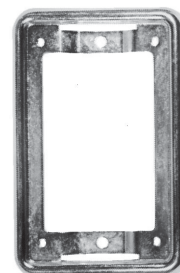

Adapter plate for mounting WLRS/WLRD covers to flush device boxes.

Description	Cat. #
Flush Device Adapter	WLRA1

Also can be used to mount all covers with four corner screws listed see pages 37, 39, 40, 41, 42 and 43 to flush device boxes.

See page 42 for receptacle specifications and listings of complete receptacle/cover combinations.
†Must be used with a wet locations rated wiring device.

2F Covers for Cast Iron or Aluminum Device Boxes

Single Gang - Raintight Covers (Gasket Included)

2F

Ordering Information

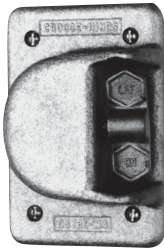

For general use snap switches.
Includes gasket.

Description	Material	Cat. #
For standard ON-OFF operation	Copper-free aluminum	DS181



For general use snap switches.
Includes gasket.

Description	Material	Cat. #
For standard ON-OFF operation. With hole for lock	Die cast aluminum	DS185



For general use snap switches.
Includes gasket.

Description	Material	Cat. #
For standard operation. Marked ON-OFF handle	Cast aluminum	DS128

Single Gang - Switches and Motor Control Push Button

Ordering Information

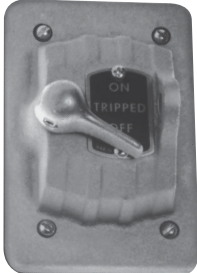

For manual motor starting switches. Fits FS and FD boxes. Takes Westinghouse switches MST01 (1-pole) and MST02 (2-pole). Includes gasket.

Description	Material	Cat. #
For standard ON-OFF operation	Feraloy iron alloy	DS199



Furnished with buttons for operating motor control push button switches. Includes gasket.

Description	Push Buttons		Material	Cat. #
	No.	Color		
Button (normally open) marked START	1	Green	Feraloy iron alloy	DS171F ①
Button (normally closed) marked STOP	1	Red	Feraloy iron alloy	DS171G ①
Button (normally open) marked START	1	Green	Feraloy iron alloy	DS171 ①
Button (normally closed) marked STOP	1	Red		

Description	No.	Color	Material	Cat. #
Two push button	2	Black	Feraloy iron alloy	DS171J ①

① If desired, markings on indicating plates may be added to catalog number. Select from the list of standard markings below:

HAND	CLOSE	OFF	AUTO.	UP	RUN
EMER.	DOWN	JOG	FORWARD	START	RESET
REVERSE	STOP	TRIP	OPEN	ON	TEST
LGT. ON					

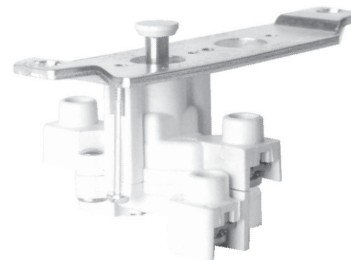

Heavy duty motor control push button switch

No. of Buttons	Normal Positions		Cat. #
1	1 circuit universal	•••	ED11
2	2 circuits universal	•••••	ED12†

†Two universal contact blocks, must be wired as two circuits, with one normally open and one normally closed.

DS Covers use the switches shown in the list below.

Cover	Takes Switch	Cover	Takes Switch
DS171	ED12	DS171F	ED11
DS171G	ED11	DS266	ED12
DS265	ED11		



Single Gang - DS Receptacles and WP Plugs

2F

Applications:

WP plugs and DS receptacles are used:

- Wherever dust, dirt, moisture and corrosion are a problem
- Outdoors or in locations where frequent washdowns occur, as in dairies and food processing plants

Features:

DS receptacle housings are used:

- With FS and FD cast device boxes, either surface mounted or installed flush in a wall
- With single gang, two gang tandem and multiple gang boxes having individual cover openings
- A threaded cap which effectively seals housing when not in use

WP plugs include:

- A molded Neoprene hood with integral sleeve to seal the cord entrance
- An aluminum ring which clamps the hood to receptacle housing face, to complete watertight seal when plug is in use

Certifications and

Compliances:

- UL Standards: 498; 514A
- NEMA/EEMAC: WD-1; WD-5
- CSA Standard: C22.2 No. 42*

*Compliance.

Standard Materials:

- Receptacle housings: body – *Feraloy*[®] iron alloy; cap – copper-free aluminum
- Plug exteriors: hood – Neoprene; fastening ring – copper-free aluminum

Standard Finishes:

- *Feraloy* iron alloy – electrogalvanized and aluminum acrylic paint
- Copper-free aluminum – natural
- Neoprene – natural (black or yellow)

Electrical Rating Ranges:

- 15 amperes, 125 volts
- 20 amperes, 125, 250 volts

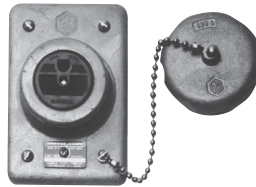

DS Receptacle housings

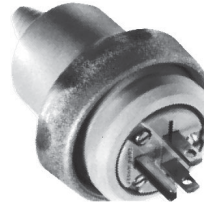

WP Plugs



CC Replacement receptacle

Grounding Type Receptacles

For Plugs with U shaped or Round Grounding Contacts

Rating	Cover With Recept. Cat. #	Diagram	Style	Plug Cat. #	Diagram	Cord Dia.	Repl. Recept. Cat. #
15 amps 125 volts	DS96*		2-wire, 3-pole†	WP820		.500 to .625	CC55
		NEMA: 5-15R			NEMA: 5-15P		
20 amps 125 volts	DS222		2-wire, 3-pole†	WP832		.500 to .625	CC71
		NEMA: 5-20R			NEMA: 5-20P		
20 amps 250 volts	DS290		2-wire, 3-pole†	WP930		.500 to .625	CC90
		NEMA: 6-20R			NEMA: 6-20P		

†Third pole grounded.
*Compliance

For listing of typical FS cast devices boxes, see pages 23 and 24.

Single Gang - Pilot Light Covers, Extensions and Adapters

Ordering Information



For pilot light units (furnished with jewels)

Description	Material	Jewel Color	Cat. #
Surface	Sheet steel	Red	DS24



Pilot light (with transformer)†, FD only

Circuit Voltage	Lamp Base	Watts	Cat. #
440	Candelabra	6	C333

†Transformer 50-60 cycle, 440 / 110 volts.

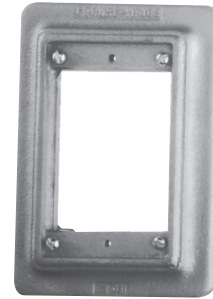

FS flush mounting adapter (can be used with multi-gang bodies having individual cover openings. Furnished with gasket and screws)

Mtg. Style	Cat. #
Wall	FS031



For pilot light units (furnished with jewel and gasket).

Description	Material	Jewel Color	Cat. #
Surface or flush	Feraloy iron alloy	Red	DS24G



EXF Extensions (takes covers and flush rectangular wiring devices, or plug receptacles with housings)

Ext. Depth	Cat. #
1"	EXF11
2½"	EXF21

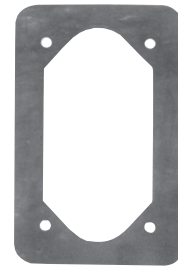

Gaskets for use between device boxes and covers.

Material	Cat. #
Neoprene	GASK91‡

‡Not recommended as watertight.

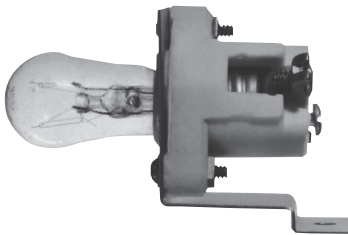

Pilot light unit (without transformer)

Circuit Voltage	Lamp Base	Watts	Cat. #
110	Candelabra	6	C3310

2F Covers for Cast Iron or Aluminum Device Boxes

Two Gang

2F

Ordering Information

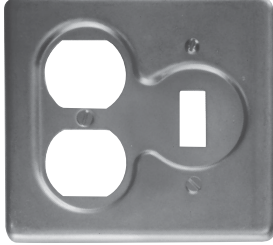

For flush general use snap switches with square handles

Material	Cat. #
Sheet steel	S32232

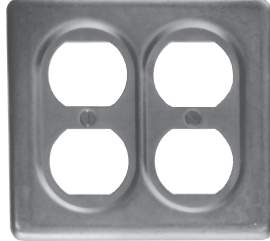

For duplex convenience receptacles, standard and 2-wire, 3-pole grounding

Description	Material	Cat. #
Surface	Sheet steel	S232

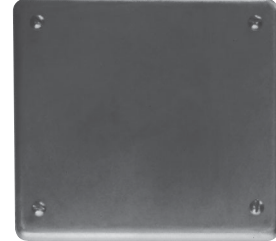

Blank. *Feraloy*® iron alloy with gasket

Description	Material	Cat. #
Surface	Sheet steel	S1002
Surface or flush	<i>Feraloy</i> iron alloy	S1002G
Surface or flush	Copper-free aluminum	S1002G SA

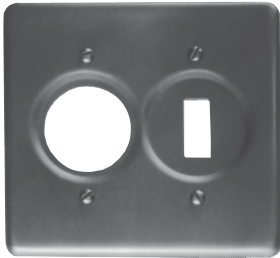

For flush general use snap switches with square handles

Description	Material	Cat. #
For round plug flush receptacles. Surface	Sheet steel	S32212



For GFI receptacles

Description	Material	Cat. #
Surface	Sheet steel	S232 GFI

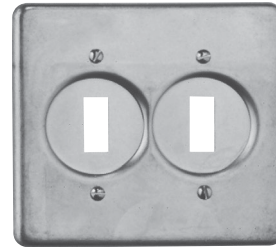

For flush general use snap switches with square handles

Description	Material	Cat. #
Surface	Sheet steel	S322

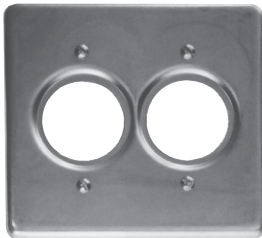

For standard and 2-wire, 3-pole grounding

Description	Material	Cat. #
For round plug flush receptacles. Surface	Sheet steel	S212



For round flush receptacles, duplex convenience receptacles, standard and 2-wire, 3-pole grounding

Description	Material	Cat. #
Surface	Sheet steel	S21232

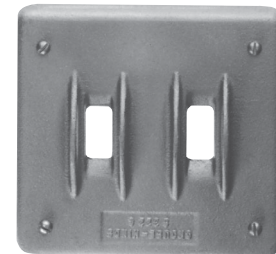

For flush general use snap switches with square handles

Description	Material	Cat. #
Surface or flush	<i>Feraloy</i> iron alloy	S322G

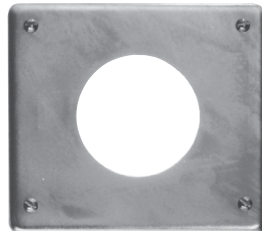

For 20 amp., 250 volt receptacles

Description	Material	Cat. #
2-pole, Surface	Sheet steel	S612

Two Gang

Ordering Information

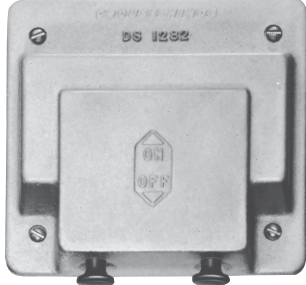

With operating mechanism and gasket

Description	Material	Cat. #
Two gang. For operation of general use snap switches. Surface or flush	Feraloy® iron alloy	DS1282

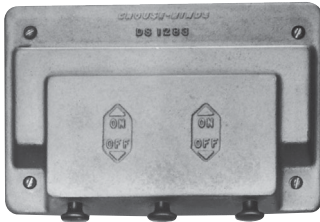

With operating mechanism and gasket

Description	Material	Cat. #
Three gang with gasket. For external operation of general use snap switches. Surface or flush.	Feraloy iron alloy	DS1283



Blank with gasket

Description	Material	Cat. #
Surface	Sheet steel	S1003
Surface or flush	Feraloy iron alloy	S1003G
Surface or flush	Copper-free aluminum	S1003G SA

*Includes gasket

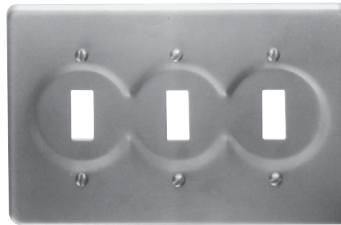

For flush general use snap switches with square handles

Description	Material	Cat. #
Surface, three gang	Sheet steel	S323

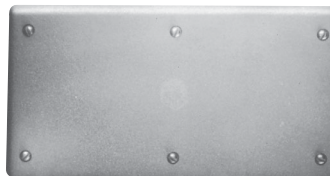

Blank with gasket

Description	Material	Cat. #
Surface or flush	Feraloy iron alloy	S1004G

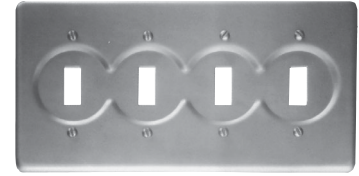

For flush general use snap switches with square handles

Description	Material	Cat. #
Surface, four gang†	Sheet steel	S324

†For FS094 and FD094 boxes.



Gasket for use between device box and cover

Description	Material	Cat. #
Two gang	Rubber	GASK434
Three gang	Rubber	GASK460
Four gang	Rubber	GASK461

2F FSE Receptacle and Breaker Assemblies

2F

Applications:

- FSE series assemblies are used in outdoor areas for supplying power in remote locations, particularly parking lots, automobile engine block heaters, marinas, drive-in theaters, trailer camps, etc.

Features:

- Compact design.
- Suitable for a variety of combinations.
- U ground duplex receptacle.
- Circuit breaker protection.
- Breakers cannot be manually tripped.

Certifications and Compliances:

- CSA Standard C22.2 No. 18

Standard Materials:

- Body and cover – copper-free aluminum

Standard Finishes:

- Copper-free aluminum – natural

Electrical Ratings:

- 15A 120V

Size:

- 2" integral hub for pole mounting.



FSE 6121



FSE 612

Ordering Information

Cat. #	Description
--------	-------------

FSE612	Double face receptacle body only
--------	----------------------------------

FSE6121	Fitting complete with 1-15 amp. duplex receptacle and blank cover.
---------	--

FSE6122	Fitting complete with 2-15 amp. duplex receptacles.
---------	---

FSE61212	Fitting complete with 1-15 amp. duplex receptacle and two 1- pole Minibreakers
----------	--

FSE61211	Fitting complete with 1-15 amp. duplex receptacle and one 1- pole Minibreaker.
----------	--

Other combinations available on request



Description	Page No.
Application/Selection	see page 48
Lubricants	
HTL	see page 63
STL	see page 63
Conduit Bodies & Outlet Boxes	
Cylindrical	
EKC	see page 60
90° Elbow	
FE	see page 62
LBH	see page 61
LBY	see page 61
Rectangular	
OE	see page 59
Round	
C30 and C31 for IEC Applications	see page 57
CPS	see page 58
GUA	see pages 50–51
EAB	see page 54
EAB ATEX	see page 55
EAJ	see page 56
GUR Universal	see page 53
Tees	
Short Radius	
ET	see page 61
FT	see page 62

Condulet® Conduit Bodies and Outlet Boxes

Application and Selection

Applications:

Hazardous area conduit bodies and outlet boxes are installed in rigid conduit systems in Class I and II hazardous locations to:

- Protect conductors
- Act as pull and splice boxes
- Connect lengths of conduit
- Change conduit direction
- Provide access to conductors for maintenance and future system changes
- Act as mounting outlets for fixtures (with appropriate covers)
- Act as sealing fittings (with appropriate covers)

Options and Accessories:

- Flat blank covers (surface and flanged flush), fixture support and sealing covers and extensions are available. See specific product listing for details.
- Lubricant (STL and HTL) are available to make joints raintight, provide for easy cover removal and to lubricate shafts over a wide temperature range.
- *Corro-free*™ epoxy powder coat – information available on request.

Considerations for Selection:

- Determine the area classification per National Electrical Code Hazardous Area Groups. Based on this classification, select the product families that are acceptable for use in the particular location.:
- Establish functional physical requirements these will help to determine box size, cover, shape and mounting for the particular installation.
- Each product family has features suitable for specific functions:
- i.e., boxes used as mountings for lighting fixtures are generally of a small size, and provided with mounting lugs when required to support lighting fixtures.
- Boxes used for wire pulling should generally be larger to provide room for easy pulling.
- Boxes used to splice and/or tap conductors should be large enough to permit ease of work and sufficient room for the required size and number of conductors.
- Hub size and configuration – dependent on the conduit system configuration and the conduit size used.
- Material and finish – determine from environmental conditions (corrosive fumes, weather, buried in concrete, etc.)



















Quick Selector Chart

Series	NEC Class I & II Groups	IEC Certifications	Normal Function	Cover Opening Diameter	Hub Size†	Cover Type
GUA	C, D E, F, G		Mtg. lgt. fixt., taps, pulling, splicing	2-5	1/2-2	Threaded
EAJ	A, B, C, D E, F, G		Pulling, splicing, taps	3 7/16 & 5	1/2-2	Threaded
C30 / C31		Ex II 2 G EEx d IIC T6 Ex II 2 D IP66 T 85°C	Pulling, splicing, taps	98mm (C30) 130mm (C31)	1/2-1	Threaded
EAB	A, B, C, D E, F, G		Pulling, splicing, taps	3	1/2-1	Threaded
EAB ATEX	A, B, C, D E, F, G	II 2 G EEx d IIC T5 PTB 05 ATEX 1052	Pulling, splicing, taps	3 3/4	1/2-1	Threaded
CPS	C, D E, F, G		Fixt. support, pulling, splicing	3 1/2	1/2 & 3/4	Ground joint
OE	C, D E, F, G		Pulling		1/2-1	Ground joint
ET	C, D E, F, G		Stub up		1/2-1	
FT		Flameproof, Exd, IIB, IP67, Zone 1 Combustible Dust Zone 21 & 22	Stub up		20mm - 25mm	Threaded
LBY	C, D E, F, G		Pulling		1/2 - 1 1/4	Threaded
LBH	B, C, D E, F, G		Pulling		1/2-4	Ground joint
FE		Flameproof, Exd, IIB, IP67, Zone 1 Combustible Dust Zone 21 & 22	Pulling		20mm - 25mm	Threaded
EKC	C, D E, F, G		Pulling		1/2-3	Ground joint
GUR	C, D E, F, G		Pulling, splicing		1/2-1	Threaded





†See following table for standard hub configuration.

Condulet® Conduit Bodies and Outlet Boxes

Standard Shape and Hub Selector

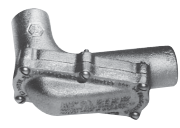
Shape Series	Page	Hub Style										
												
 GUA	see pages 50-52	GUA	GUAB	GUAC	GUAD	GUAL	GUAM	GUAN	GUAT	GUAW	GUAX	
 EAB	see page 54			EABC		EABL			EABT		EABX	EABY
 C30 / C31	see page 57								C30 / C31		C30 / C31	
 EAJ	see page 56		EAJB	EAJC	EAJD	EAJL			EAJT		EAJX	
 CPS	see page 58											CPS
 GUR	see page 53											GUR
 OE	see page 59		OELB	OEC		OELL		OELR	OET			

The fittings below are available only in the configurations shown.

					
LBH see page 61	LBY see page 61	FE see page 62	EKC see page 60	ET see page 61	FT see page 62



Condulet® Conduit Outlet Boxes With Covers

GUA Series

Cl. I, Div. 1 & 2, Groups C, D
 Cl. II, Div. 1, Groups E, F, G
 Cl. II, Div. 2, Groups F, G
 Cl. III
 NEMA 3, 4, 7CD, 9EFG

Explosionproof
 Dust-Ignitionproof
 Raintight
 Wet Locations

3F

Applications:

GUA series conduit outlet boxes are installed within hazardous area conduit systems to:

- Protect conductors in threaded rigid conduit
- Act as pull and splice boxes
- Connect lengths of conduit
- Change conduit direction
- Provide access to conductors for maintenance and future system changes
- Act as mounting outlets for fixtures (with appropriate covers)
- Act as sealing fittings (with appropriate covers)

Features:

GUA conduit boxes have:

- Neoprene "O" ring standard to meet NEMA 4 requirements
- Cast ears on cover to permit easy removal and tightening
- Four standard mounting pads except for boxes with bottom hubs
- Threaded cover openings
- Ten different hub arrangements
- Taper threaded hubs to provide grounding continuity
- Smooth integral hub bushing protects conductor insulation when pulling
- Surface covers furnished with boxes
- Sealing covers, dome covers, and fixture hanger covers are available
- Cover threads are 12 pitch

Certifications and Compliances:

- NEC/CEC:
 - Class I, Division 1 & 2, Groups C, D
 - Class II, Division 1, Groups E, F, G
 - Class II, Division 2, Groups F, G
 - Class III
- UL Standard: 1203
- ANSI Standard: C33.27
- CSA Standard: C22.2 No. 30
- NEMA/EEMAC 3, 4

Standard Materials:

- Bodies – *Feraloy* iron alloy
- Covers – Copper-free aluminum

Standard Finishes:

- *Feraloy* iron alloy – electrogalvanized and aluminum acrylic paint
- Aluminum – natural

Size Ranges:

- Hub – 1/2" to 2"
- Cover opening – 2" to 5" dia.

Options:

Description
 Bodies – copper-free aluminum
 Covers – *Feraloy* iron alloy – electrogalvanized and aluminum acrylic paint
 GUA Form 6 (with 3" cover opening) are available with optional cover with viewing window.
WOD
VW
S752
Suffix
SA†*

To order box less cover add "0" to end of catalog number ie.GUAT260.

When assembled with sealing type cover, GUA series outlet boxes provide adequate sealing for 40% fill in hazardous areas – Class I, Groups C, D; Class II, Groups E, F, G; and Class III. Seals can be made in either horizontal or vertical positions. Use *Chico*® "A" sealing compound or *Chico*® SpeedSeal only. Conductor splices or connections must not be made in enclosures where sealing compound is to be used per NEC.

GUA



Hub Size	Cover Opening Dia.	Cat. #
1/2	2	GUA14
3/4	2	GUA24
1/2	3	GUA16
3/4	3	GUA26*
1	3	GUA36
1 1/4	3 5/8	GUA47
1 1/2	5	GUA59

GUAC



Hub Size	Cover Opening Dia.	Cat. #
1/2	2	GUAC14†
3/4	2	GUAC24†
1/2	3	GUAC16*
3/4	3	GUAC26*
1	3	GUAC36*
1 1/4	3 5/8	GUAC47†
1 1/4	5	GUAC49
1 1/2	5	GUAC59†
2	5	GUAC69†

†Available in copper-free aluminum, add suffix -SA.
 *Available in copper-free aluminum, add suffix -SA. GUA outlet boxes marked with * when ordered with suffix -SA are listed for Class I, Division 1 & 2, Groups B, C and D, Class II, Division 1, Groups E, F, G and Class III. Covers have 16 pitch threads. Replacement cover is a GUA06-GB.

GUAB



Hub Size	Cover Opening Dia.	Cat. #
1/2	2	GUAB14†
3/4	2	GUAB24
1/2	3	GUAB16*
3/4	3	GUAB26*
1	3	GUAB36*
1 1/4	3 5/8	GUAB47†
1 1/2	5	GUAB59†
2	5	GUAB69†

GUAD

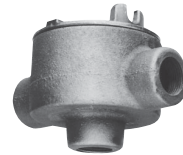

Hub Size	Cover Opening Dia.	Cat. #
1/2	2	GUAD14†
3/4	2	GUAD24
1/2	3	GUAD16
3/4	3	GUAD26†
1	3	GUAD36†
1 1/4	5	GUAD49

Dimensions In Inches:

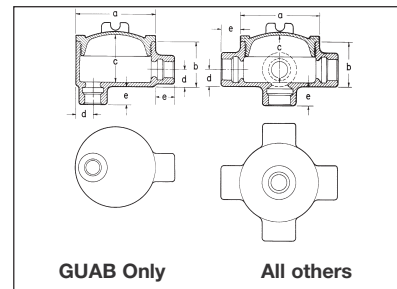

GUA, GUAD, GUAM, GUAW, GUAX

Cat. #	a	b	c	d
14	2 1/2	1 13/16	1 3/4	5/8
24	2 1/2	2	2	3/4
16	3 1/2	2	1 7/8	5/8
26	3 1/2	2	1 7/8	3/4
36	3 1/2	2 5/16	2 3/16	7/8
37	4 1/4	2 5/16	2 7/8	7/8
47	4 1/4	2 11/16	2 3/4	1 3/32
49	5 3/4	3 3/16	3 3/4	1 3/32
59	5 3/4	3 13/16	3 3/4	1 9/32
69	5 3/4	4 1/16	4	1 9/16

Length of Hub Hub Size	Dimension "e" Length
1/2 - 3/4	7/8
1 - 1 1/4	1
1 1/2 - 2	1 1/16

Crouse-Hinds
 by **E.T.N**

Condulet® Conduit Outlet Boxes With Covers

GUA Series

Cl. I, Div. 1 & 2, Groups C, D
 Cl. II, Div. 1, Groups E, F, G
 Cl. II, Div. 2, Groups F, G
 Cl. III
 NEMA 3, 4, 7CD, 9EFG

Explosionproof
 Dust-Ignitionproof
 Raintight
 Wet Locations

3F

GUAL



Hub Size	Cover Opening Dia.	Cat. #
1/2	2	GUAL14†
3/4	2	GUAL24†
1/2	3	GUAL16*
3/4	3	GUAL26*†
1	3	GUAL36*
1 1/4	3 5/8	GUAL47†
1 1/4	5	GUAL49†
1 1/2	5	GUAL59†
2	5	GUAL69†

GUAN



Hub Size	Cover Opening Dia.	Cat. #
1/2	2	GUAN14
3/4	2	GUAN24
1/2	3	GUAN16
3/4	3	GUAN26
1	3	GUAN36†
1 1/4	3 5/8	GUAN47
1 1/2	5	GUAN59†
2	5	GUAN69

GUAT



Hub Size	Cover Opening Dia.	Cat. #
1/2	2	GUAT14†
3/4	2	GUAT24†
1/2	3	GUAT16*
3/4	3	GUAT26*
1	3	GUAT36*
1	3 5/8	GUAT37
1 1/4	3 5/8	GUAT47†
1 1/4	5	GUAT49†
1 1/2	5	GUAT59†
2	5	GUAT69†

GUAX



Hub Size	Cover Opening Dia.	Cat. #
1/2	2	GUAX14†
3/4	2	GUAX24†
1/2	3	GUAX16*
3/4	3	GUAX26*
1	3	GUAX36*
1	3 5/8	GUAX37†
1 1/4	3 5/8	GUAX47†
1 1/4	5	GUAX49
1 1/2	5	GUAX59†
2	5	GUAX69†

GUAM



Hub Size	Cover Opening Dia.	Cat. #
1/2	2	GUAM14†
3/4	2	GUAM24
1/2	3	GUAM16
3/4	3	GUAM26
1	3	GUAM36
1 1/4	3 5/8	GUAM47
2	5	GUAM69

GUAW



Hub Size	Cover Opening Dia.	Cat. #
1/2	2	GUAW14†
3/4	2	GUAW24†
1/2	3	GUAW16
3/4	3	GUAW26*†

Dimensions GUAC, GUAT

Cat. #	a	b	c	d
14	2 1/2	2 1/4	2 3/16	5/8
24	2 1/2	2	2	3/4
16	3 1/2	2	1 7/8	5/8
26	3 1/2	2	1 7/8	3/4
36	3 1/2	2 3/16	2 3/16	7/8
37	4 1/4	2 3/16	2 3/8	7/8
47	4 1/4	2 11/16	2 3/4	1 3/32
49	5 3/4	3 13/16	3 3/4	1 5/32
59	5 3/4	3 13/16	3 3/4	1 9/32
69	5 3/4	4 1/16	4	1 9/16

GUAN

Cat. #	a	b	c	d
14	2 1/2	2 1/8	2 1/16	5/8
24	2 1/2	2 3/16	2 1/4	3/4
16	3 1/2	2	1 7/8	3/4
26	3 1/2	2	1 7/8	3/4
36	3 1/2	2 3/16	2 3/8	7/8
47	4 1/4	2 11/16	2 3/4	1 3/32
59	5 3/4	4 1/16	4	1 9/32
69	5 3/4	4 1/16	4	1 9/16

GUAB, GUAL

Cat. #	a	b	c	d
14	2 1/2	2 1/4	2 3/16	5/8
24	2 1/2	2 1/2	2 7/16	3/4
16	3 1/2	2	1 7/8	5/8
26	3 1/2	2	1 7/8	3/4
36	3 1/2	2 3/16	2 3/16	7/8
47	4 1/4	2 11/16	2 3/4	1 3/32
49	5 3/4	3 13/16	3 3/4	1 5/32
59	5 3/4	3 13/16	3 3/4	1 9/32
69	5 3/4	4 1/16	4	1 9/16

†Available in copper-free aluminum, add suffix -SA.

*Available in copper-free aluminum, add suffix -SA. GUA outlet boxes marked with * when ordered with suffix -SA are listed for Class I, Division 1 & 2, Groups B, C and D, Class II, Division 1, Groups E, F, G and Class III. Covers have 16 pitch threads. Replacement cover is a GUA06-GB.

3F Covers and Accessories

For GUA Condulet® Conduit Outlet Boxes

3F

Applications:

Threaded covers, canopies and extensions are used:

- To provide a seal in hazardous areas (sealing cover). See note below.
- To mount pendant lighting fixtures such as EVA listed in lighting section (fixture canopy)
- To mount EVA pendant lighting fixtures on cover which is then screwed into outlet box without twisting conductors (union hub cover)
- To mount pendant lighting fixtures on cover which is then screwed into outlet box as above, for wiring after fixture stem is installed (nipple cover)
- To provide means of increasing outlet box depth (threaded extension)

Features:

- Surface covers are supplied with GUA boxes
- Sealing cover has removable plug for filling enclosure with sealing compound after installation. Sealing cover meets 40% fill requirement of the NEC®. See note below.
- Fixture canopy has a threaded cover in its side to provide access for making splices or taps. Fixture with its conduit stem and canopy can be assembled and wired before installation and conductors can be spliced in canopy after it has been screwed into the body
- Cover threads are 12 pitch.

Standard Materials:

- Surface and dome covers, union hub covers, nipple covers – copper-free aluminum
- Sealing covers, fixture canopies, threaded extensions – *Feraloy*® iron alloy

Standard Finishes:

- Aluminum – natural
- *Feraloy* iron alloy – electrogalvanized and aluminum acrylic paint

Options:

Description	Suffix
<i>Corro-free</i> ™ epoxy powder coat	S752
To order an iron surface cover	WOD

Size Ranges:

- Fixture stems – 3/4"
- Body openings – 2" to 5"

Note: Depth of sealing compound in body must satisfy requirements of NEC section 501-5 (C-3). Splices and taps in sealing fittings are prohibited by NEC.

GUA Threaded Extension



Cover Opening Dia.	Ext. Depth	Cat. #
3	1 1/4	GUA0631

GUA Cover Opening	Replacement O-Ring Gasket Cat. #
2"	GASK1713
3"	GASK1151
3 5/8"	GASK1589
5"	GASK925

Surface Cover



Cover Opening Dia.	Thread Pitch	Cat. #
2	12	GUA04
3	12	GUA06
3	16	GUA06 GB*
3 5/8	12	GUA07
5	12	GUA09

Dome Cover



Cover Opening Dia.	Ext. Depth	Thread Pitch	Cat. #
2	2	12	GUA047
3	2	12	GUA067
3 5/8	2	12	GUA077
3 5/8	4	12	GUA0716
5	4	12	GUA514
5	10	12	GUA5110

Sealing Cover



Cover Opening Dia.	Thread Pitch	Cat. #
2	12	GUA041
3	12	GUA062
3	16	GUA062 GB*
3 5/8	12	GUA072†
5	12	GUA092

Nipple Cover



Cover Opening Dia.	Fixt. Stem Size	Thread Pitch	Cat. #
3	3/4	12	GUA0672

Fixture Cover Union Hub Type



Cover Opening Dia.	Fixt. Stem Size	Thread Pitch	Cat. #
3	3/4	12	GUA0687

Fixture Canopy



Cover Opening Dia.	Fixt. Stem Size	Thread Pitch	Cat. #
3	3/4	12	GUA068

†Also used with GUP bodies see page 753 or GU and GUE bodies see page 722.

*GUA covers with 16 pitch threads are used with GUA bodies ordered with -SA suffix identified with * symbol see pages 50-51.

Condulet® Conduit Outlet Boxes With Covers

GUR Series

Cl. I, Div. 1 & 2, Groups C, D
 Cl. II, Div. 1, Groups E, F, G
 Cl. II, Div. 2, Groups F, G
 Cl. III
 NEMA 4

Explosionproof
 Dust-Ignitionproof
 Raintight
 Wet Locations

3F

Applications:

GUR conduit outlet boxes are installed within hazardous areas:

- To protect conductors in threaded rigid conduit
- To act as pull and splice boxes
- To connect lengths of conduit
- To provide access to conductors for maintenance and future system changes
- To change conduit direction
- Where space is limited, such as underneath gasoline pumps

Features:

GUR outlet boxes feature:

- Neoprene O-ring standard in cover to meet NEMA 4/UL Type 4 requirements
- Internal green ground screw
- Five standard hubs with three pipe plugs included
- Threaded cover opening
- Recesses in cover to assist in cover tightening and removal
- Smooth, integral hub bushing to protect conductor insulation when pulling
- Compact design for confined spaces
- UL and cUL listing
- Optional all-aluminum construction

Certifications and Compliances:

- NEC/CEC
 - Class I, Division 1 and 2, Groups C and D
 - Class II, Division 1, Groups E, F and G
 - Class III
 - Zone 1 and 2
- UL Standard 1203
- cUL to CSA Standard C22.2 No. 30
- NEMA 4

Standard Materials:

- Bodies – *Feraloy*® iron alloy
- Covers – copper-free aluminum

Standard Finishes:

- *Feraloy* iron alloy – electrogalvanized with aluminum acrylic paint
- Aluminum – natural

Options:

Description

Bodies – copper-free aluminum

Suffix
SA



Ordering Information:

Hub Size	Cat. #
1/2"	GUR1
3/4"	GUR2
1"	GUR3

Dimensions

In Inches:

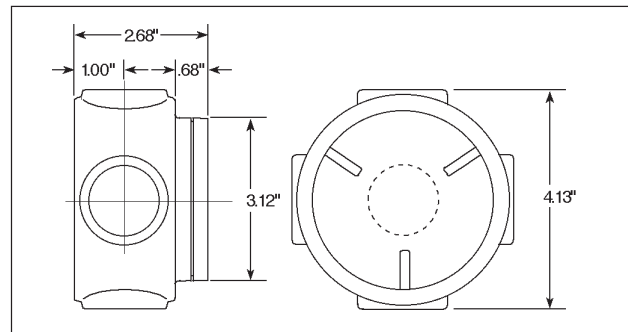

Condulet® Conduit Outlet Boxes With Covers

EAB Series

Cl. I, Div. 1 & 2, Groups A, B, C, D
 Cl. II, Div. 1, Groups E, F, G
 Cl. II, Div. 2, Groups F, G
 Cl. III
 NEMA 3,4,7ABCD,9EFG

Explosionproof
 Dust-Ignitionproof
 Raintight
 Wet Locations

3F

Applications:

EAB series conduit outlet boxes are installed in conduit systems within hazardous areas to:

- Provide protection against exterior explosion where acetylene, hydrogen and other hazardous gases are present
- Protect conductors in threaded rigid conduit
- Act as pull and splice boxes
- Interconnect lengths of conduit
- Change conduit direction
- Provide access to conductors for maintenance and future system changes

Features:

EAB series conduit outlet boxes have:

- Five different hub configurations
- Taper threaded hubs to provide ground continuity
- Smooth integral hub bushing to protect conductor insulation when pulling
- Threaded cover openings
- Surface covers furnished with boxes
- Neoprene "o"-ring gasket and green ground screw are both standard.
- Four standard mounting pads, except for EABY.
- Cover threads are 16 pitch.

Certifications and Compliances:

- NEC/CEC:
 - Class I, Division 1 & 2, Groups A, B, C, D
 - Class II, Division 1, Groups E, F, G
 - Class II, Division 2, Groups F, G
 - Class III
- UL Standard: 1203
- CSA Standard: C22.2 No. 20

Standard Finishes:

- *Feraloy* – electrogalvanized and aluminum acrylic paint
- Aluminum – natural

Standard Materials:

- Bodies – *Feraloy*® iron alloy
- Covers – Copper-free aluminum

Options:

Description

Bodies – copper-free aluminum
 Covers – *Feraloy* iron alloy – electrogalvanized and aluminum acrylic paint
 Corro-free epoxy powder coat

Suffix
SA†*

WOD
S752

Size Ranges:

- Hub – 1/2" to 1"
- Cover opening – 3" dia.

EABC

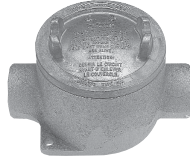

Hub Size	Cat. #
1/2	EABC16†
3/4	EABC26
1	EABC36†

EABT



Hub Size	Cat. #
1/2	EABT16†
3/4	EABT26†
1	EABT36†

EABL



Hub Size	Cat. #
1/2	EABL16†
3/4	EABL26†
1	EABL36†

Dimensions In Inches:

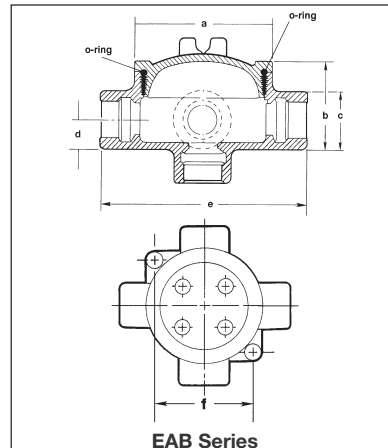

†Available in copper-free aluminum, add suffix -SA.
 *EAB0687 is listed for Group C & D only.

EABX

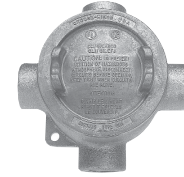

Hub Size	Cat. #
1/2	EABX16†
3/4	EABX26†
1	EABX36†

EABY



Hub Size	Cat. #
1/2	EABY16†
3/4	EABY26†

Replacement Cover:

Size	Cat. #
3"	EAB06

Replacement O-Ring:

Description	Cat. #
Replacement O-Ring	GASK1151

Fixture Cover Union Hub Type



Cover Opening Dia.	Fixt. Stem Size	Cat. #
3"	3/4	EAB0687*

EAB Series

Cat. #	a	b	c	d	e	f
16	3/4	2 ¹⁷ / ₃₂	1 1/2	3/4	5 ⁹ / ₁₆	3 ³ / ₃₂
26	3/4	2 ²⁵ / ₃₂	1 3/4	7/8	5 ⁹ / ₁₆	3 ³ / ₃₂
36	3/4	2 ²⁵ / ₃₂	1 3/4	7/8	5 ⁹ / ₁₆	3 ³ / ₃₂

Condulet® Conduit Outlet Boxes With Covers

EAB Series with UL, cUL and ATEX Certifications

Cl. I, Div. 1 & 2, Groups A, B, C, D
 Cl. II, Div. 1 & 2, Groups E, F, G
 II 2 G EEx d IIC T5
 PTB 05 ATEX 1052
 UL and cUL Listed

Explosionproof
 Dust-Ignitionproof
 Raintight
 Wet Locations
 Type 4 Enclosure / IP66

3F

Applications:

EAB ATEX series conduit outlet boxes are installed in conduit systems within hazardous areas to:

- Provide protection against exterior explosion where acetylene, hydrogen and other hazardous gases are present
- Protect conductors in threaded rigid conduit
- Act as pull and splice boxes
- Interconnect lengths of conduit
- Change conduit direction
- Provide access to conductors for maintenance and future system changes

Features:

EAB ATEX series conduit outlet boxes have:

- Two different hub configurations
- Taper threaded hubs to provide ground continuity
- Smooth integral hub bushing to protect conductor insulation when pulling
- Threaded cover openings
- Surface covers furnished with boxes
- Neoprene "o"-ring gasket and green ground screw are both standard.
- Cover threads are 16 pitch.

Certifications and Compliances:

- NEC/CEC:
 - Class I, Division 1 & 2, Groups A, B, C, D
 - Class II, Division 1 & 2, Groups E, F, G
 - Class III
 - II 2 G EEx d IIC T5
 - PTB 05 ATEX 1052
- UL Standard: 1203
- cUL Listed to CSA Standard: C22.2 No. 30
- Type 4 Enclosure
- IP66

Standard Materials:

- Bodies – *Feraloy*® iron alloy or copper-free aluminum
- Covers – Copper-free aluminum

Standard Finishes:

- *Feraloy* – electrogalvanized and aluminum acrylic paint
- Aluminum – natural

Options:

Description

Covers – *Feraloy* iron alloy – electrogalvanized and aluminum acrylic paint
Corro-free epoxy powder coat

Suffix to be added to Cat. #

WOD

S752

Size Ranges:

- Hub – 1/2" to 1"
- Cover opening – 3" dia.

EABX

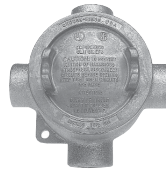

Hub Size	Body Material	Cat. # †
1/2	<i>Feraloy</i> ® Iron	EABX16 ATEX
1/2	Copper-free Aluminum	EABX16 SA ATEX
3/4	<i>Feraloy</i> ® Iron	EABX26 ATEX
3/4	Copper-free Aluminum	EABX26 SA ATEX
1	<i>Feraloy</i> ® Iron	EABX36 ATEX
1	Copper-free Aluminum	EABX36 SA ATEX

Dimensions In Inches:

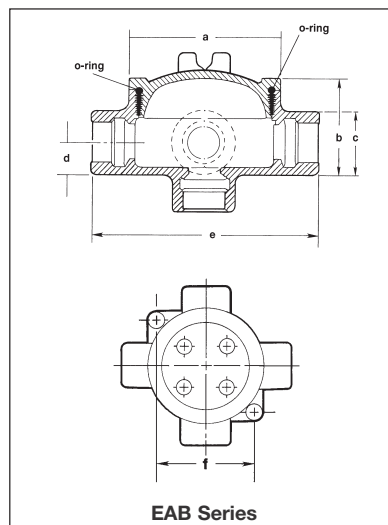

†Available with 6-point Phoenix MBK type terminal block mounted on DIN rail. Add suffix DIN16 before ATEX.
 Ordering example: EABX26 DIN16 ATEX
 *EAB0687 is listed for Group C & D only.

EABY



Hub Size	Body Material	Cat. # †
1/2	<i>Feraloy</i> ® Iron	EABY16 ATEX
1/2	Copper-free Aluminum	EABY16 SA ATEX
3/4	<i>Feraloy</i> ® Iron	EABY26 ATEX
3/4	Copper-free Aluminum	EABY26 SA ATEX

Replacement Cover:

Size	Cat. #
3"	EAB06

Replacement O-Ring:

Description	Cat. #
Replacement O-Ring	GASK1151

Fixture Cover Union Hub Type



Cover Opening Dia.	Fixt. Stem Size	Cat. #
3"	3/4	EAB0687*

EAB Series

Cat. #	a	b	c	d	e	f
16	3/4	2 17/32	1 1/2	3/4	5 9/16	3 3/32
26	3/4	2 25/32	1 3/4	7/8	5 9/16	3 3/32
36	3/4	2 25/32	1 3/4	7/8	5 9/16	3 3/32

Condulet® Conduit Outlet Boxes With Covers

EAJ Series

Cl. I, Div. 1 & 2, Groups A†, B, C, D
 Cl. II, Div. 1, Groups E, F, G
 Cl. II, Div. 2, Groups F, G
 Cl. III
 NEMA 3, 4, 7ABCD, 9EFG

Explosionproof
 Dust-Ignitionproof
 Raintight
 Wet Locations

3F

Applications:

EAJ series conduit outlet boxes are installed in conduit systems within hazardous areas to:

- Protect conductors in threaded rigid conduit
- Act as pull and splice boxes
- Interconnect lengths of conduit
- Change conduit direction
- Provide access to conductors for maintenance and future system changes
- Act as mounting outlets for fixtures (with appropriate covers)
- Act as sealing fittings (with appropriate covers)

Features:

EAJ conduit outlet boxes have:

- Water shedding cover – suitable for wet locations when mounted in upright position
- External cover threads on body protecting conductors from damage during pulling
- No pinching of conductors during cover installation
- Six different hub arrangements
- Taper threaded hubs to provide ground continuity
- Smooth integral hub bushing to protect conductor insulation when pulling
- Internally threaded cover openings for additional wiring room
- Flat overlapping threaded covers furnished with boxes
- Weather-resistant finish
- Green ground screw standard in all boxes
- Four standard mounting pads, except for EAJB and EAJD

Certifications and Compliances:

- NEC/CEC:
 - Class I, Division 1 & 2, Groups A†,B,C,D
 - Class II, Division 1, Groups E,F,G
 - Class II, Division 2, Groups F,G
 - Class III
- UL Standard: 1203
- CSA Standard: C22.2 No. 30

Standard Materials:

- Body – *Feraloy*® iron alloy
- Cover – copper-free aluminum

Standard Finishes:

- *Feraloy* iron alloy – electrogalvanized and aluminum acrylic paint
- Aluminum – natural

Options:

Description	Suffix
Bodies – copper-free aluminum	SA†
Covers – <i>Feraloy</i> iron alloy – electrogalvanized and aluminum acrylic paint	WOD
Corro-free epoxy powder coat	S752

Size Ranges:

- Hub – 1/2" to 2"
- Cover opening – 3/16" to 5" dia.

EAJB

Cover Opening Dia.	Hub Size	Cat. #
3/16	1/2	EAJB16†
3/16	3/4	EAJB26†
3/16	1	EAJB36†

EAJC

Cover Opening Dia.	Hub Size	Cat. #
3/16	1/2	EAJC16†
3/16	3/4	EAJC26†
3/16	1	EAJC36†

EAJD

Cover Opening Dia.	Hub Size	Cat. #
3/16	1/2	EAJD16†
3/16	3/4	EAJD26†
3/16	1	EAJD36†

EAJL

Cover Opening Dia.	Hub Size	Cat. #
3/16	1/2	EAJL16†
3/16	3/4	EAJL26†
3/16	1	EAJL36†

EAJT

Cover Opening Dia.	Hub Size	Cat. #
3/16	1/2	EAJT16†
3/16	3/4	EAJT26†
3/16	1	EAJT36†
5	1 1/4	EAJT49††
5	1 1/2	EAJT59††
5	2	EAJT69††

EAJX

Cover Opening Dia.	Hub Size	Cat. #
3/16	1/2	EAJX16†
3/16	3/4	EAJX26†
3/16	1	EAJX36†

EAJ Threaded Covers



Flat Covers

Cover Opening Dia.	Cat. #
3/16	EAJ06
5	EAJ09

Dome Covers



Cover Opening Dia.	Depth	Cat. #
3/16	2	EAJ0612

Fixture Covers



Union Hub Type

Cover Opening Dia.	Fixt. Stem Size	Cat. #
3/16	3/4	EAJ0687*

Dimensions In Inches:

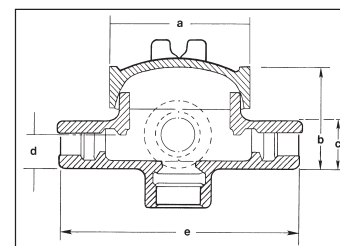

Cat. #	a	b	c	d	e	f
16	3/4	2 17/32	1 1/2	3/4	5 5/16	3 3/32
26	3/4	2 25/32	1 3/4	7/8	5 9/16	3 3/32
36	3/4	2 29/32	1 3/4	7/8	5 9/16	3 3/32
49	5/4	4 1/16	2 3/16	1 3/32	7 5/16	4 3/4
59	5 3/4	4 1/16	3	1 1/2	7 13/16	4 3/4
69	5 3/4	4 1/16	3	1 1/2	7 13/16	4 3/4

*EAJ0687 is listed for Group C & D only.
 †Available in copper-free aluminum, add suffix -SA.
 ‡Form 9 products with 5" cover opening are not suitable for Group A.

Condulet® Conduit Outlet Boxes With Covers

Ex II 2 G EEx d IIC T6
Ex II 2 D IP66 T 85°C

Zone 1, 2, 21 and 22

3F

for IEC Applications

Applications:

C30 and C31 series conduit outlet boxes are installed in electrical systems within hazardous areas to:

- Provide protection against exterior explosion where acetylene, hydrogen and other hazardous gases are present
- Protect conductors in threaded rigid conduit
- Act as pull and splice boxes
- Interconnect lengths of conduit
- Change conduit direction
- Provide access to conductors for maintenance and future system changes

Features:

C30 and C31 series conduit outlet boxes have:

- Taper threaded hubs to provide ground continuity
- Smooth integral hub bushing to protect conductor insulation when pulling
- Threaded cover openings
- Surface covers furnished with boxes
- Neoprene "o"-ring gasket and green ground screw are both standard
- Cover threads are 16 pitch

Certifications and Compliances:

- IEC:
 - Ex d IIC T6
 - Ex tD A21 IP67 T85°C
 - EC-Type examination certificate LOM 02 ATEX 2037 X
 - Compliant to EN60079-0
- IP67

Standard Materials:

- Bodies – Light alloy, natural finish
- Covers – Light alloy, natural finish

Technical Specifications

Operating temperature range	-50°C to +55°C
Degree of protection	IP67
Rated voltage	up to 690V
Rated current	Acc. terminals
Terminals	C30 Series: up to 6mm ² C31 Series: up to 10 mm ²

C30 Series



C31 Series

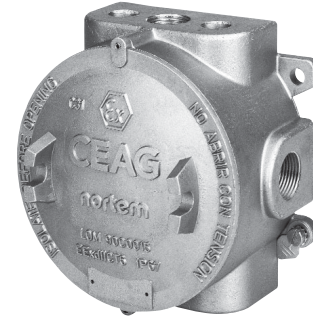

Ordering Information

Series	Shape	Hub Size	Cat. # †
C30	T	3 x 1/2"	NOR 000 001 151 181
C30	T	3 x 3/4"	NOR 000 001 151 199
C30	X	4 x 1/2"	NOR 000 001 151 206
C30	X	4 x 3/4"	NOR 000 001 151 214
C31	T	3 x 1/2"	NOR 000 111 150 001
C31	T	3 x 3/4"	NOR 000 111 150 002
C31	T	3 x 1"	NOR 000 111 150 003
C31	X	4 x 1/2"	NOR 000 111 150 004
C31	X	4 x 3/4"	NOR 000 111 150 005
C31	X	4 x 1"	NOR 000 111 150 006

Accessories

Description	Cat. #
C30 Mounting plate with pillar terminals 4 x 4mm ²	NOR 000 001 151 222
C30 support rail DIN 46877	NOR 000 000 115 314
C30 mounting plate without terminals	NOR 000 000 115 302
C30 pending support	NOR 000 000 115 311
C31 mounting plate with pillar terminals 4 x 4mm ²	NOR 000 111 150 009
C31 mounting plate without terminals	NOR 000 000 115 306
C31 support rail DIN 46877	NOR 000 000 115 315

Dimensions

In Inches:

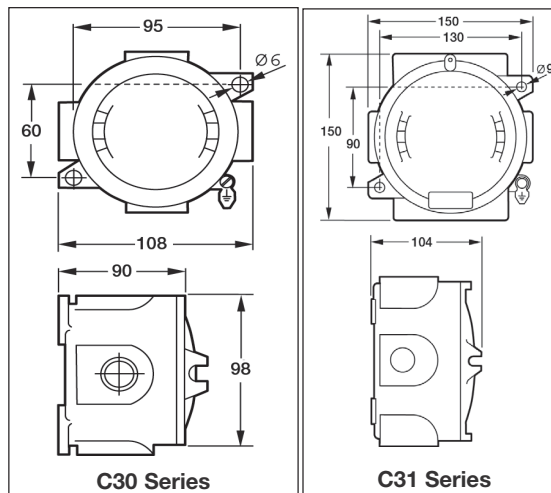

†Other entries available upon request.

Condulet® Conduit Outlet Boxes With Covers

CPS Series

Cl. I, Div. 1 & 2, Groups C, D
 Cl. II, Div. 1, Groups E, F, G
 Cl. II, Div. 2, Groups F, G
 Cl. III
 NEMA 7CD,9EFG

Explosionproof
 Dust-Ignitionproof

3F

Applications:

CPS series conduit outlet boxes are installed in conduit systems in hazardous areas to:

- Protect conductors in threaded rigid conduit
- Act as pull and splice boxes
- Change conduit direction
- Interconnect lengths of conduit
- Act as fixture hangers with hub covers
- Provide access to conductors for maintenance and future system changes

Features:

CPS conduit outlet boxes have:

- Two types of cover:
 - blank for splice or pull box use
 - threaded hub for mounting light fixtures
- Wide, accurately machined body and cover mating surfaces, to insure flamtight joint
- Blind tapped holes for cover screws to further insure flamtightness
- Removable mounting feet for flush or surface mounting to wall or ceiling

Certifications and Compliances:

- NEC/CEC
 - Class I, Division 1 & 2, Groups C, D
 - Class II, Division 1, Groups E, F, G
 - Class II, Division 2, Groups F, G
 - Class III
- UL Standard: 1203
- CSA Standard C22.2 No. 30

Standard Materials:

- Feraloy® iron alloy

Standard Finishes:

- Electrogalvanized and aluminum acrylic paint

Options:

Description	Suffix
Corro-free™ epoxy powder coat	S752

Box with Hub Cover

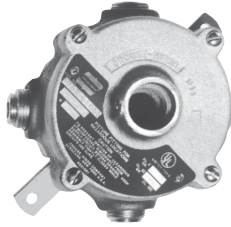

Hub Size	Cover	Cat. #
3/4	1/2	CPS12021
3/4	3/4	CPS12022

‡Furnished with four 3/8" standard taper tapped, integrally bushed hubs. Three hubs are plugged.

Box with Blank Cover

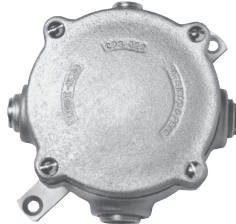

Hub Size	Cat. #
3/4	CPS12026

CPS Covers



Blank Covers

Description	Cat. #
Form 20	CPS026

Hub Covers*

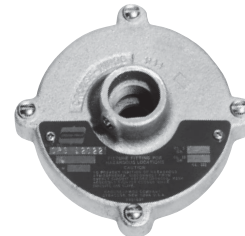

Description	Hub Size	Cat. #
Form 20	1/2	CPS021
Form 20	3/4	CPS022

*Fixture weight up to 125 lbs.

Dimensions

In Inches:

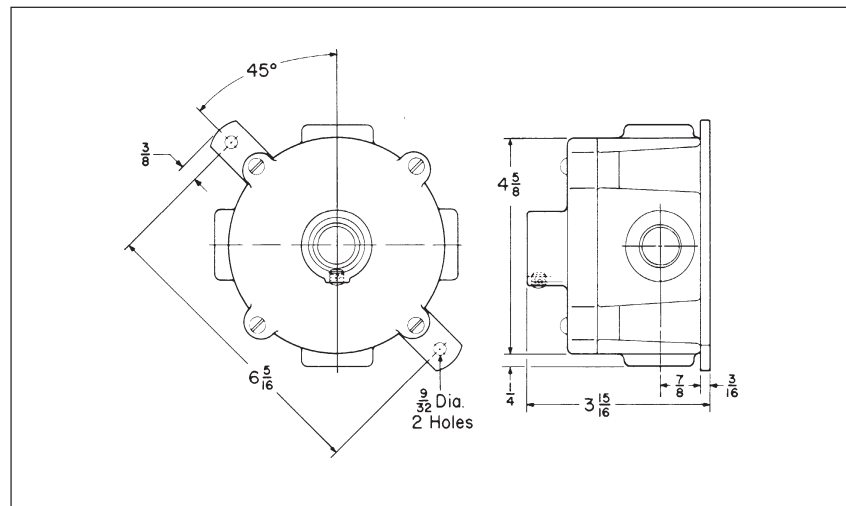

Complete line of fixture hangers are located in section 7L of this catalog.

Condulet® Conduit Bodies With Covers

OE Series

Cl. I, Div. 1 & 2, Groups C, D
 Cl. II, Div. 1, Groups E, F, G
 Cl. II, Div. 2, Groups F, G
 Cl. III
 NEMA 7CD, 9EFG

Explosionproof
 Dust-Ignitionproof

3F

3F

Applications:

OE series are installed in conduit systems within hazardous areas to:

- Protect conductors in threaded rigid conduit
- Act as pulling and splice fittings
- Interconnect lengths of conduit
- Change direction of conduit
- Provide access for maintenance and future system changes

Features:

OE conduit outlet bodies have:

- Taper threaded hubs for ground continuity
- Smooth integral hub bushings to protect conductor insulation when pulling
- Five different hub arrangements
- Accurately machined body with blind tapped screw holes
- Most compact design of all hazardous area outlet bodies

Certifications and Compliances:

- NEC/CEC:
 - Class I, Division 1 & 2, Groups C, D
 - Class II, Division 1, Groups E, F, G
 - Class II, Division 2, Groups F, G
 - Class III
- UL Standard: 1203
- CSA Standard: C22.2 No. 30

Standard Materials:

- Feraloy® iron alloy (1/2" and 3/4" fittings)
- Copper-free aluminum (1" fittings)

Standard Finishes:

- Electrogalvanized and aluminum acrylic paint

Options:

Description Corro-free™ epoxy powder coat
Suffix S752

Size Ranges:

- Hub - 1/2" to 1"

OEC



Hub Size	Cat. #
1/2	OEC1
3/4	OEC2
1	OEC3 SA

OET

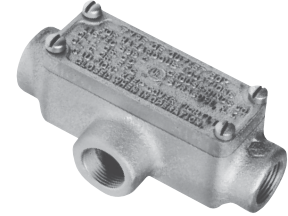

Hub Size	Cat. #
1/2	OET1
3/4	OET2
1	OET3 SA

OELL

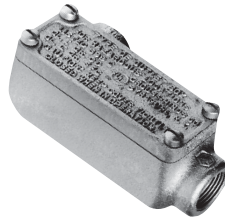

Hub Size	Cat. #
1/2	OELL1
3/4	OELL2
1	OELL3 SA

OELB

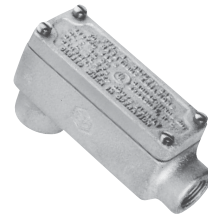

Hub Size	Cat. #
1/2	OELB1
3/4	OELB2
1	OELB3 SA

OELR

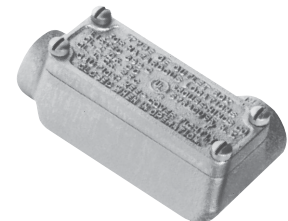

Hub Size	Cat. #
1/2	OELR1
3/4	OELR2
1	OELR3 SA

Dimensions In Inches:

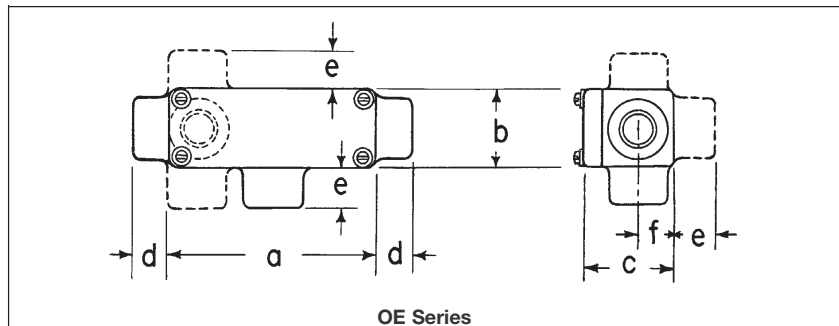

Hub Size in.	a	b	c	d	e	f
1/2	4 1/16	1 9/16	1 13/16	1 1/16	7/8	3/8
3/4	4 5/16	1 7/8	2 1/16	1 1/16	7/8	3/4

3F Condulet® Conduit Bodies With Covers

EKC Series

Cl. I, Div. 1 & 2, Groups C, D Explosionproof
 Cl. II, Div. 1, Groups E, F, G Dust-Ignitionproof
 Cl. II, Div. 2, Groups F, G
 Cl. III
 NEMA 7CD,9EFG

3F

Applications:

EKC series conduit outlet bodies are installed in conduit systems within hazardous areas to:

- Provide convenient opening in conduit system for pulling or splicing conductors

Features:

EKC bodies have:

- Accurately machined body and cover mating surfaces to ensure flamtight joint when properly assembled
- Extra long cover opening to facilitate pulling and splicing of conductors
- Taper threaded hubs and integral bushing for rigid threaded conduit

Certifications and Compliances:

- NEC:
 - EKC 30 – 60
 - Class I, Division 1 & 2, Groups C, D
 - Class II, Division 1, Groups E, F, G
 - Class II, Division 2, Groups F, G
 - Class III
 - EKC 70, 80
 - Class I, Division 1 & 2, Group D
 - Class II, Division 1, Groups E, F, G
 - Class II, Division 2, Groups F, G
 - Class III
- UL Standard: 1203
- CSA Standard: C22.2 No. 30

Standard Materials:

- EKC bodies – *Feraloy* iron alloy

Standard Finishes:

- *Feraloy* – electrogalvanized and aluminum acrylic paint

Options:

Description	Suffix
EKC series: <i>Corro-free</i> ™ epoxy powder coat	S752

Size Ranges:

- EKC bodies – hub size – 1" to 3"

Ordering Information



EKC

Hub Size	Cat. #
1	EKC30
1¼	EKC40
1½	EKC50
2	EKC60
2½	EKC70
3	EKC80

Dimensions In Inches:

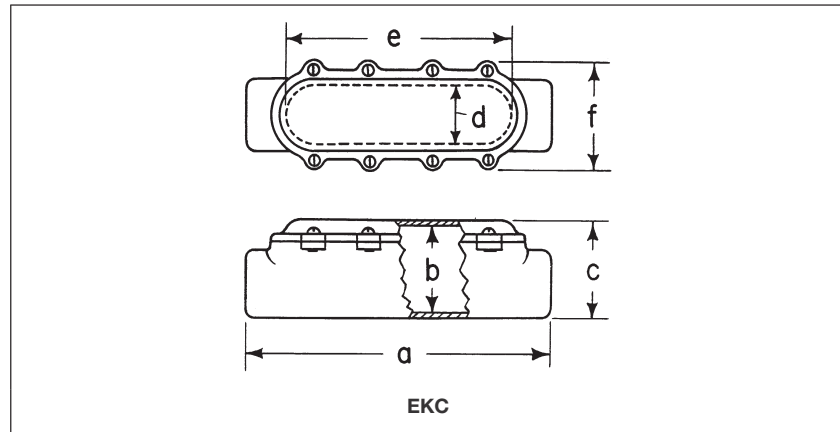

EKC

Size	a	b	c	d	e	f
1 – 1¼	12 ⁵ / ₁₆	3 ¹ / ₁₆	3 ⁷ / ₁₆	1 ³ / ₄	9	4
1½ – 2	15 ¹⁵ / ₁₆	3 ⁷ / ₈	4 ⁵ / ₁₆	2 ¹ / ₂	12	5
2½ – 3	21 ³ / ₄	5 ¹ / ₂	6	3 ³ / ₄	16	6 ⁵ / ₈

Condulet® Conduit Bodies With Covers; Elbows and Tees

LBH, LBY, ET Series

Cl. I, Div. 1 & 2, Groups A, B, C, D*
Cl. II, Div. 1, Groups E, F, G
Cl. II, Div. 2, Groups F, G
Cl. III
NEMA 7ABCD,9EFG

Explosionproof
Dust-Ignitionproof

3F

Applications:

LBH conduit outlet bodies are installed in hazardous areas to:

- Act as pull outlets especially for conductors that are stiff due to large size or type of insulation
- Make 90° bends in conduit system, allowing straight pull in either direction
- Provide for conduit service entrance to buildings
- Provide for conductor entrance to motors
- Provide access to wiring for maintenance and future system changes

LBY elbows are installed in conduit systems within hazardous areas to:

- Make 90° bends in conduit systems where space is limited
- Act as pull outlets
- Provide access to conductors for maintenance and future system changes

ET series short radius tees are installed in conduit systems within hazardous areas to:

- Allow single conduit stub up to outlet and device boxes located above or below main conduit runs. Eliminates separate feed and return conduits

Features:

LBH bodies have:

- Cover openings on an angle, permitting conductors to be pulled straight through hubs from either direction
- Domed covers to permit easy conductor bends (relieves strain on insulation)
- Taper threaded hubs with integral bushings

LBY elbows have:

- Maximum volume for bends within a compact overall size
- Screw on cover for ease of installation and removal
- Over opening on an angle, permitting conductors to be pulled straight through either hub
- Taper threaded hubs and integral bushing for rigid threaded conduit

ET short radius tees have:

- Compact size and small radius of bend for use in concealed, or open conduit systems.
- Particularly suited for use in shallow floors or partitions
- Taper threaded hubs and integral bushing for rigid threaded conduit

Certifications and Complies:

- NEC:
 - LBH 10-20 –
 - Class I, Division 1 & 2, Groups B, C, D
 - Class II, Division 1, Groups E, F, G
 - Class II, Division 2, Groups F, G
 - Class III
 - LBH 30-100
 - Class I, Division 1 & 2, Group D
 - Class II, Division 1, Groups E, F, G
 - Class II, Division 2, Groups F, G
 - Class III
 - LBY –
 - Class I, Division 1 & 2, Groups C, D
 - Class II, Division 1, Groups E, F, G
 - Class II, Division 2, Groups F, G
 - Class III
 - ET –
 - Class I, Division 1 & 2, Groups A, B, C, D
 - Class II, Division 1, Groups E, F, G
 - Class II, Division 2, Groups F, G
 - UL Standard: 1203
 - CSA Standard: C22.2 No. 30

Standard Materials:

- LBH, LBY and ET – *Feraloy*® iron alloy

Standard Finishes:

- LBH, LBY and ET – electrogalvanized and aluminum acrylic paint

Dimensions In Inches:

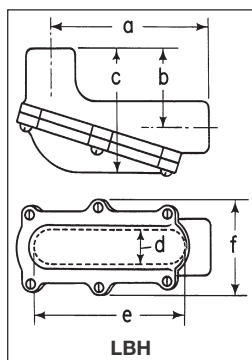

LBH

Size	a	b	c	d	e	f
1/2-3/4	5 1/16	2 19/32	4	1 3/16	4	2 3/4
1-1/4	7 7/8	3 13/32	5 1/4	1 3/4	7	4
1 1/2	10 15/16	4 1/2	7 3/32	2 1/2	10	5
2	10 21/32	4 25/32	7 3/32	2 1/2	10	5
2-1/2-3	15 5/8	5 1/2	9 1/2	3	15 3/4	5 5/8
3-1/2-4	23 3/16	6 11/16	11 3/4	4	24	7 1/8

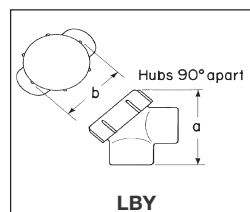

LBY

Size	a	b
1/2	2 9/16	2
3/4	2 13/16	2 1/4
1	3 3/32	2 1/2
1 1/4	3 3/4	2 15/16
1 1/2	4 1/4	3 3/8

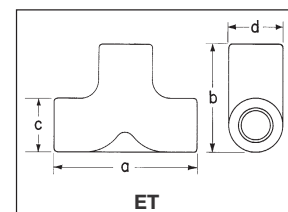

ET

Size	a	b	c	d
3/4-1/2-1/2	4	2 5/8	1 1/4	1 1/2
3/4-3/4-3/4	4	3	1 1/2	1 1/2
1-3/4-3/4	4	3	1 1/2	1 3/4

Options:

Description	Suffix
LBH and LBY series – copper-free aluminum	SA
LBH and LBY series – <i>Corro-free</i> ™ epoxy powder coat	S752

Size Ranges:

- LBH bodies – hub size 1/2" to 4"
- LBY elbows – hub size 1/2" to 1 1/2"

Ordering Information

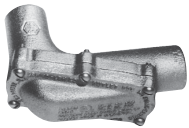
LBH	Hub Size	Cat. #
	1/2	LBH10
	3/4	LBH20
	1	LBH30
	1 1/4	LBH40
	1 1/2	LBH50
	2	LBH60
	2 1/2	LBH70
	3	LBH80
	3 1/2	LBH90
	4	LBH100

LBY	Hub Size	Cat. #
	1/2	LBY15
	3/4	LBY25
	1	LBY35
	1 1/4	LBY45
	1 1/2	LBY55

ET	Hub Size	Cat. #
	3/4-1/2-1/2 ‡	ET218
	3/4-3/4-3/4 ‡	ET228
	1-3/4-3/4 ‡	ET328

‡Largest hub is shown at top of photo.

FE and FT Series

3F

Applications:

FE and FT conduit fittings are installed in hazardous areas to:

- Act as draw-in outlets especially for cables that are stiff due to large size or type of insulation
- Make 90° bends in conduit systems, allowing for a straight pull in either direction
- Provide access to wiring for maintenance and future system changes

Features:

- Maximum volume for bends within a compact overall size
- Large openings to facilitate cable pulling

Certifications and Compliances:

Type of Protection

- Ex d, DIP A21, IP67

Degree of Protection

- IP67

Gas Group

- IIB

Approvals

- Ex1108U

Standard Materials:

- Body – Copper-free aluminum
- Cover – Brass

Standard Finishes:

- Natural

Options:

Description **Suffix**
NPT & BSP thread sizes **Consult Factory**



Ordering Information:
Inspection Elbows and Tees Selection

Cat. #	Type	Entry Size (metric)
FE1	Elbow	M20 (F)-M20 (F)
FE2	Elbow	M25 (F)-M25 (F)
FT1	Tee	M20 (F)-M20 (F)
FT2	Tee	M25 (F)-M25 (F)

Dimensions (mm)

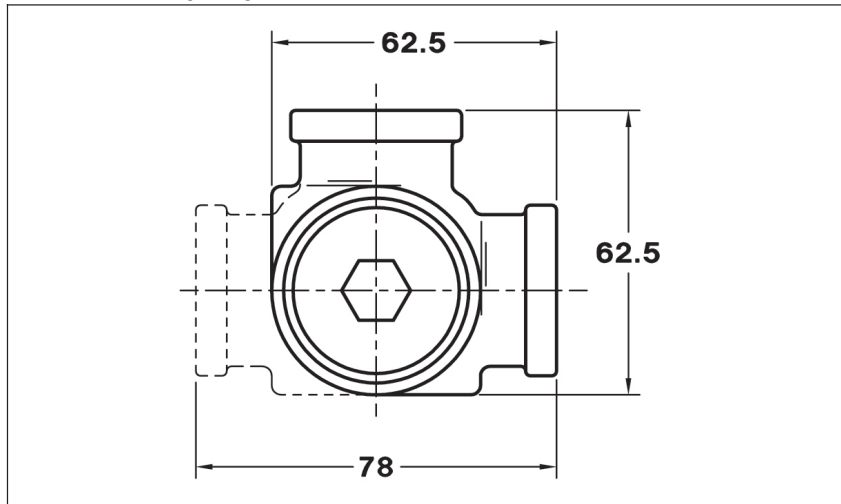

Applications:

- STL thread lubricant is used between any screw thread and its tapped opening, on any rotating shaft – threaded or plain, and to inhibit corrosion on any metal-to-metal joint of apparatus and control enclosures.
- HTL high temperature lubricant is used on lighting fixture threaded joints and on threaded joints of the enclosures of any heat-producing apparatus or control.

Features:

STL thread lubricant is lithium based, antigalling and:

- Is especially effective between parts made of dissimilar metals
- Is effective and stable from -20°F to +300°F
- Maintains grounding continuity; should not be used on exposed current-carrying parts
- Has excellent adhesion qualities; a liberal application on threaded joints maintains raintightness and inhibits corrosion

HTL is a high temperature, anti-seize, conductive thread lubricant:

- Effective and stable from -70°F to +1800°F
- Prevents seizure, galling, rust, galvanic action
- Maintains grounding continuity; should not be used on exposed current-carrying parts
- Effective between parts made of dissimilar metals

Certifications and Compliances:

- Complies with NEC 2008, Article 300.6

STL Thread Lubricant



Net Wt.	Cat. #
1 3/4 oz. (tube)	STL2
8 oz. (can)	STL8

HTL High Temperature Thread Lubricant



Net Wt.	Cat. #
4 oz. (tube)	HTL4

MSDS Sheets are available at www.crouse-hinds.com

3F

3F



Cable Glands and Cable Accessories Hazardous and Non-hazardous

4F

Description	Page No.	Description	Page No.
Application	see page 66	Cable Glands - Accessories	
Cable Glands - International Standards		A Series	see page 96
Quick Selection Guide	see pages 67–70	B Series	see page 100
Flameproof and Increased Safety		D Series	see page 101
ADE 1F	see page 71	E Series	see page 102
ADE 4F	see page 72	Breathers and Drains	see page 103
ADE 6F	see page 73	Cable Tray Clamps	
ADE 6FC	see page 74	Conduit	
ADE 1FC	see page 75	LCC, LCCF Series	see page 104
Ex - e	see page 76	Grounding Conductor	
Ex - i	see page 77	TGC Series	see page 105
Trumpet	see page 78	Cable/Conduit Sealing Devices	
Enlargement and Multiple	see page 79	Thru-Wall Barrier®	
Industrial		TW Series	see pages 106–107
ADE 4I	see page 80	Link Seal – For Conduit	
Cable Glands - North American Standards		Environmental Seal	see pages 112–113
Quick Selection Guide	see pages 67–70	Fire Seal	see pages 114–115
Explosionproof			
Terminator™ II TMCX	see pages 81–82		
TMCX	see page 83		
ADE 6FC	see page 84		
ADE 1FC	see page 85		
CGBS	see page 86		
EBY	see page 86		
General Purpose			
TMC	see page 87		
TECK	see page 88		
CGB	see pages 89–90		
CGD	see page 91		
CGE	see page 92		
CGB1013	see page 93		
CGFP	see page 94		
NCG	see page 95		
NCGB	see page 95		



Application and Selection

Applications:

Cable glands and cord fittings:

- Provide means for passing a cord, cable (armored or unarmored) or flexible conduit into an enclosure, through a bulkhead or into a rigid conduit
- Form a mechanical grip and water and/or oil-resistant seal for cord and unarmored or jacketed armored, round cables
- Form a non-slip connection or termination for flexible cord, cable (armored or unarmored), or flexible conduit
- Provide grounding continuity for cable armor and flexible conduit

Cable glands with sealing fitting or epoxy are installed to:

- Provide means for passing armored, metal clad, jacketed or unjacketed and unarmored cables through a bulkhead or enclosure in hazardous areas. These fittings are suitable for use in Class I, Groups C, D locations only when Chico® A sealing compound or TSC epoxy (TMCX) is used to make the seal in the fitting*
- Form a mechanical grip and water and/or oil-resistant termination
- Provide ground continuity of cable armor and flexible conduit

TMC (non-hazardous) and TMCX (hazardous) fittings are designed for use with Type MC jacketed steel or aluminum metal clad cables with interlocked or corrugated armor and Type TC tray cable (TMCX).

LCC cable tray conduit clamps are used for installation on cable tray side rails with inside flanges (requiring inside tray mounting) and outside flanges; LCCF clamps are for use exclusively on inside flanges. LCC/LCCF series cable tray conduit clamps are installed to:

- Provide a means of clamping metal conduit (rigid steel or aluminum, IMC and EMT) to cable tray for the exit of power and/or control cables from tray
- Provide a means to firmly bond exiting conduit to cable tray for best grounding continuity

TW Series THRU-WALL BARRIER® cable/conduit sealing devices are installed to:

- Seal cables or conduits penetrating fire rated walls, ceilings, or floors
- Restrict entrance of water and dust and contain treated air
- Provide a seal for cable/conduit penetrations through steel, masonry or concrete; to restrict the entrance of contaminants through cable/conduit penetrations into clean areas









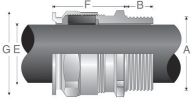

TGC cable tray grounding conductor clamp provides a means for securely attaching a grounding conductor to cable tray to provide grounding continuity for the entire tray system. TGC cable tray grounding conductor clamps provide a reliable method for carrying ground fault current for equipment protection. TGC clamp may be installed on most types of cable trays – with inside or outside flanges.

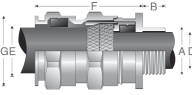
Considerations for Selection:

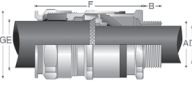
- Selection of the proper cable gland involves consideration of the type of cable to be installed and the environment that will surround the cable after installation.
- A proper matching of the cable and its gland is necessary to prevent physical damage to the cable when installed. Some types of cable glands depend on gripping methods (set screws, etc.) which may lead to damage of the cable outer covering. Eaton's Crouse-Hinds cable glands and cord fittings utilize compression of split lead or tapered neoprene bushings to provide high gripping strength for adequate cable support and strain relief without damage to the cable sheath.
- Compression of bushing provides a strong electrical bond that assures grounding continuity.
- Compression of a tapered neoprene bushing assures the watertight integrity of Eaton's Crouse-Hinds cable glands. Additional watertightness, to prevent water seepage into the fitting body, can be obtained by use of a potting head filled with a hot pouring compound.
- To meet National Electrical Code requirements for electrical installations in hazardous atmospheres, a sealing fitting may be required in conjunction with the cable or cord fitting.

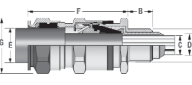
*With specific cords and cables when installed in accordance with NEC/CEC requirements.

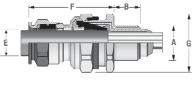
Quick Selection Guide - International Standards









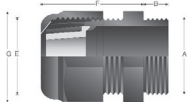

CABLE GLAND	ILLUSTRATION	CABLE TYPE	GLAND TYPE	STANDARD MATERIAL	CERTIFICATION	PROTECTION TYPE
ADE 1F (see page 71)		Non-armoured, armoured and tray cable (does not terminate the armour)	Non-armoured	Nickel-plated brass		Flameproof & Increased Safety
ADE 4F (see page 72)		SWA, SWB, STA, braided marine shipboard and lead sheathed (with addition of earthing washer)	Armoured	Nickel-plated brass		Flameproof & Increased Safety
ADE 6F (see page 73)		SWA, SWB, STA and braided marine shipboard	Armoured	Nickel-plated brass		Flameproof & Increased Safety
ADE 6FC (see page 74)		SWA, SWB, STA, braided marine shipboard and lead sheathed (with addition of earthing washer)	Armoured barrier	Nickel-plated brass		Flameproof & Increased Safety
ADE 1FC (see page 75)		Non-armoured, armoured and tray cable (does not terminate the armour)	Non-armoured barrier	Nickel-plated brass		Flameproof & Increased Safety

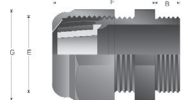
4F

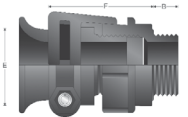
4F Global Cable Glands

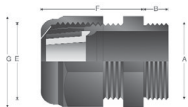
Quick Selection Guide - International Standards

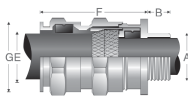
4F

CABLE GLAND	ILLUSTRATION	CABLE TYPE	GLAND TYPE	STANDARD MATERIAL	CERTIFICATION	PROTECTION TYPE
Ex - e (see page 76)		Non-armoured	Non-armoured	Polyamide		Increased Safety
Ex - i (see page 77)		Non-armoured	Non-armoured	Polyamide		Increased Safety
Trumpet (see page 78)		Non-armoured	Non-armoured	Polyamide		Increased Safety
Enlargement and Multiple (see page 79)		Non-armoured	Non-armoured	Polyamide		Increased Safety
ADE 4I (see page 80)		SWA, SWB, STA, braided marine shipboard and lead sheathed (with addition of earthing washer)	Armoured	Nickel-plated brass		Industrial

Quick Selection Guide - North American Standards











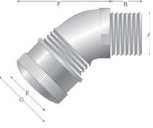

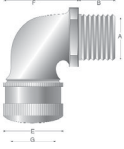
CABLE GLAND	ILLUSTRATION	CABLE TYPE	GLAND TYPE	STANDARD MATERIAL	CERTIFICATION	PROTECTION TYPE
Terminator™ II TMCX X (see pages 81–82)		Metal-clad, TECK (interlocked and continuously welded corrugated armoured), unarmoured, and tray cable	Armoured barrier, non-armoured barrier, and TECK armoured	Aluminum	UL UL US LISTED	Explosionproof
TMCX (see page 83)		Metal-clad with interlocked or continuously welded corrugated, TECK armoured, non-armoured and tray cable	Armoured barrier and non-armoured barrier	Aluminum	UL SP	Explosionproof
ADE 1FC (see page 85)		Non-armoured, armoured and tray cable (does not terminate the armour)	Non-armoured barrier	Nickel-plated brass	IECEX CE C/CEPEL UL US LISTED	Flameproof & Increased Safety
ADE 6FC (see page 84)		SWA, SWB, STA, braided marine shipboard and lead sheathed (with addition of earthing washer)	Armoured barrier	Nickel-plated brass	IECEX CE C/CEPEL UL US LISTED	Flameproof & Increased Safety
CGBS (see page 86)		Non-armoured and tray cable	Portable cord connector	Body: steel Gland nut: aluminum	SP	Explosionproof
EBY (see page 86)		Non-armoured	Portable cord connector	Aluminum	UL US LISTED	Explosionproof
TMC (see page 87)		Metal-clad with interlocked or continuously welded corrugated, TECK armoured, non-armoured and tray cable	Armoured or non-armoured	Aluminum	UL US LISTED	General Purpose
TECK (see page 88)		TECK armoured	Armoured	Aluminum	SP	General Purpose
CGB (see pages 89–90)		Non-armoured and tray cable	Non-armoured	Body steel Form A-D steel Form E-F iron	UL US LISTED	General Purpose

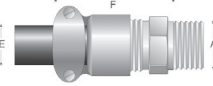
4F

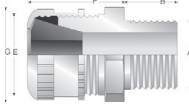
4F Global Cable Glands

Quick Selection Guide - North American Standards

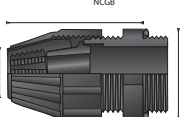
4F

CABLE GLAND	ILLUSTRATION	CABLE TYPE	GLAND TYPE	STANDARD MATERIAL	CERTIFICATION	PROTECTION TYPE
CGD (see page 91)		Non-armoured and tray cable	Non-armoured	Body: iron Gland nut: steel		General Purpose
CGE (see page 92)		Non-armoured and tray cable	Non-armoured	Body: iron Gland nut: steel		General Purpose
CGB1013 (see page 93)		Non-armoured and tray cable	Portable cord connector	Body: steel Gland nut: aluminum		General Purpose
CGFP (see page 94)		Non-armoured and tray cable	Non-armoured	Form B-C: steel Form D-G: iron		General Purpose
NCG (see page 95)		Non-armoured and tray cable	Non-armoured	Polyamide		General Purpose
NCGB (see page 95)		Non-armoured and tray cable	Non-armoured	Thermoplastic polyester		General Purpose

ADE 1F

International Standards - Flameproof and Increased Safety

ATEX
IECEX
cULus Listed for Class I, Zone 2
cULus Marine Listed for Class I, Zone 2

CEPEL
GOST-R
NEPSI
NEMA 4X and IP68

4F

Gland Type:

Non-armoured

Cable Type:

Non-armoured, armoured and tray cable (does not terminate the armour)

Certifications and Compliances:

- ATEX LCIE 97 ATEX 6008X – Exd IIC/Exe II/Ex tD /Ex II 2 GD
- IECEX LCI 05.0004X
- cULus Listed for Class I Zone 2 AEx e II/Ex e II E310130
- cULus Marine Listed for Class I Zone 2 AEx e II/Ex e II E314047
- NEMA 4X and IP68
- CEPEL cepel-EX-558/05X
- GOST-R POCC FR.B02011
- NEPSI N° GYJ071336U & GYJ071337U

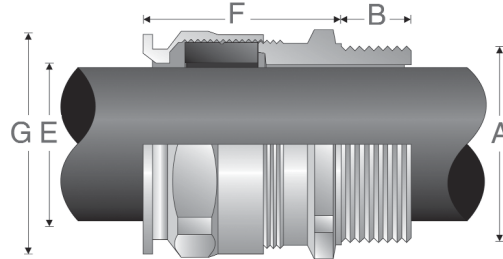

Features:

- Standard material is nickel-plated brass for superior corrosion resistance
- Provides a flameproof and weatherproof seal on the outer sheath of the cable
- Standard neoprene seal suitable for use in operating temperatures ATEX (-60°C to 100°C), IECEX and cULus (-40°C to 100°C)
- Available with optional silicone seal for extreme temperatures
- Available with metric or NPT threads
- See pages 96–103 for related accessories

ORDERING EXAMPLE:	OPTIONS (replace last digit with option number):
<div style="border: 1px solid black; padding: 5px; display: inline-block;"> CAP81640 4 KX </div>	9 Stainless steel (316L) 8 Bronze 7 Aluminum 5 Silicone sealing ring with temperature range of -70°C to 220°C K1 Includes locknut and fiber washer K2 Includes locknut, fiber washer, earth tag, and shroud
Gland Type	Options

SELECTION TABLE

Gland Size	Entry Thread Size 'A'				Thread Length 'B' Metric (NPT)	Cable Acceptance Outer Sheath 'E'		Gland Length 'F' (less entry)	Hexagon Dimensions	
	Metric Size	Metric Catalog #	NPT Size	NPT Catalog #		Min	Max		Across Flats	Across Corners 'G'
4	M12	CAP816404	1/4"	CAP818404	15 (12.0)	4.0	8.0	20	-	16.5
4	M16	CAP816594	3/8"	CAP818594	15 (12.0)	4.0	8.5	20	-	20.9
5	M16	CAP816504	1/2"	CAP818694	15 (12.0)	6.0	12.0	22	-	20.9
4	M20	CAP816674	1/2"	CAP818674	15 (20.2)	4.0	8.5	20	-	26.4
5	M20	CAP816694	1/2"	CAP818694	15 (20.2)	6.0	12.0	22	-	26.4
6	M20	CAP816604	1/2"	CAP818604	15 (20.2)	8.5	16.0	25	-	26.4
5	M25	CAP816774	3/4"	CAP818774	15 (20.2)	6.0	12.0	22	-	33
6	M25	CAP816794	3/4"	CAP818794	15 (20.2)	8.5	16.0	25	-	33
7	M25	CAP816704	3/4"	CAP818704	15 (20.2)	12.0	21.0	27	-	33
7	M32	CAP816894	1"	CAP818894	15 (25.3)	12.0	21.0	27	-	39.6
8	M32	CAP816804	1"	CAP818804	15 (25.3)	16.0	27.5	34	-	45.1
8	M40	CAP816994	1 1/4"	CAP818994	15 (26.0)	16.0	27.5	34	-	48.4
9	M40	CAP816904	1 1/4"	CAP818904	15 (26.0)	21.0	34.0	36	-	52.8
9	M50	CAP817094	1 1/2"	CAP819094	15 (26.5)	21.0	34.0	36	-	60.5
10	M50	CAP817004	1 1/2"	CAP819004	15 (26.5)	27.0	41.0	39	-	60.5
11	M63	CAP817294	2"	CAP819294	17 (27.2)	33.0	48.0	41	-	73.7
12	M63	CAP817204	2"	CAP819204	17 (27.2)	40.0	56.0	43	-	79.2
12	M75	CAP817394	2 1/2"	CAP819494	18 (40.5)	40.0	56.0	43	-	88
13	M75	CAP817304	2 1/2"	CAP819404	18 (40.5)	47.0	65.0	49	-	93.5
14	M90	CAP817594	3"	CAP819594	22 (42.0)	54.0	74.0	56	-	104.5
15	M90	CAP817504	3"	CAP819504	22 (42.0)	63.0	78.0	61	-	121
16	M110	CAP817794	3 1/2"	CAP819604	22 (43.2)	72.0	92.0	62	-	132

4F

ADE 4F

International Standards -
Flameproof and Increased Safety

ATEX
IECEX
cULus Listed for Class I, Zone 2
cULus Marine Listed for Class I,
Zone 1

CEPEL
GOST-R
NEPSI
NEMA 4X and IP68

4F

Gland Type:

Armoured

Cable Type:

Steel wire armoured, steel wire braided, steel tape armoured, braided marine shipboard and lead sheathed (with addition of earthing washer)

Certifications and Compliances:

- ATEX LCIE 97 ATEX 6008X – Exd IIC/Exe II/Ex td/Ex II 2 GD
- IECEX LCI 05.0004X
- cULus listed for Class I, Zone 2 AEx e II/Ex e II E310130
- cULus Marine listed for Class I, Zone 1 AEx e II/Ex e II E314047
- NEMA 4X and IP68
- CEPEL cepel-EX-559/05X
- GOST-R POCC FR.B02011
- NEPSI N° GYJ071336U & GYJ071337U

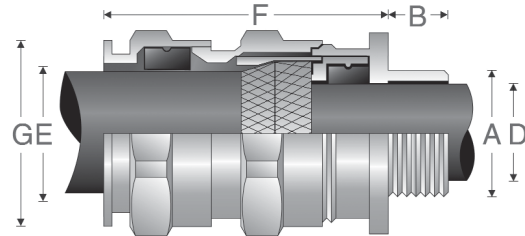

Features:

- Standard material is nickel-plated brass for superior corrosion resistance
- Armour clamping and bonding with no reversible components for easy installation, minimizing error
- Provides flameproof seal on inner jacket and weatherproof seal on outer sheath of cable
- Optional earthing washer for use with lead sheathed cable (see page 97)
- Standard neoprene seal suitable for use in operating temperatures ATEX (-60°C to 100°C), IECEX and cULus (-40°C to 100°C)
- Available with optional silicone seal for extreme temperatures
- Available with metric or NPT threads
- See pages 96–103 for related accessories

ORDERING EXAMPLE:	OPTIONS (replace last digit with option number):
<div style="border: 1px solid black; padding: 5px; display: inline-block;">CAP84640 4 KX</div>	9 Stainless steel (316L) 8 Bronze 7 Aluminum 5 Silicone sealing ring with temperature range of -70°C to 220°C K1 Includes locknut and fiber washer K2 Includes locknut, fiber washer, earth tag, and shroud
Gland Type	Options

SELECTION TABLE

Gland Size	Entry Thread Size 'A'				Thread Length 'B' Metric (NPT)	Cable Acceptance				Armour (max)	Gland Length 'F' (less entry)	Hexagon Dimensions	
	Metric Size	Metric Catalog #	NPT Size	NPT Catalog #		Inner Sheath 'D'		Outer Sheath 'E'				Across Flats	Across Corners 'G'
						Min	Max	Min	Max				
5	M12	CAP846404	1/4"	CAP848404	15 (12.0)	4.0	8.0	6.0	12.0	0.9	36	-	20.9
5	M16	CAP846594	3/8"	CAP848594	15 (12.0)	4.0	8.5	6.0	12.0	0.9	36	-	20.9
6	M16	CAP846504	3/8"	CAP848504	15 (12.0)	6.0	12.0	8.5	16.0	1.25	42	-	26.4
5	M20	CAP846674	1/2"	CAP848674	15 (20.2)	4.0	8.5	6.0	12.0	0.9	36	-	26.4
6	M20	CAP846694	1/2"	CAP848694	15 (20.2)	6.0	12.0	8.5	16.0	1.25	42	-	26.4
7	M20	CAP846604	1/2"	CAP848604	15 (20.2)	8.5	16.0	12.0	21.0	1.25	46	-	33.0
6	M25	CAP846774	3/4"	CAP848774	15 (20.2)	6.0	12.0	8.5	16.0	1.25	42	-	33.0
7	M25	CAP846794	3/4"	CAP848794	15 (20.2)	8.5	16.0	12.0	21.0	1.25	46	-	33.0
8	M25	CAP846704	3/4"	CAP848704	15 (20.2)	12.0	20.5	16.0	27.5	1.6	56	-	45.1
8	M32	CAP846894	1"	CAP848894	15 (25.3)	12.0	21.0	16.0	27.5	1.6	56	-	45.1
9	M32	CAP846804	1"	CAP848804	15 (25.3)	16.0	27.5	21.0	34.0	1.6	63	-	52.8
9	M40	CAP846994	1 1/4"	CAP848994	15 (26.0)	16.0	27.5	21.0	34.0	1.6	63	-	52.8
10	M40	CAP846904	1 1/4"	CAP848904	15 (26.0)	21.0	34.0	27.0	41.0	2.0	68	-	60.5
10	M50	CAP847094	1 1/2"	CAP849094	15 (26.5)	21.0	34.0	27.0	41.0	2.0	68	-	60.5
11	M50	CAP847004	1 1/2"	CAP849004	15 (26.5)	27.0	41.0	33.0	48.0	2.5	74	-	70.4
12	M63	CAP847294	2"	CAP849294	17 (27.2)	27.0	41.0	33.0	48.0	2.5	77	-	79.2
13	M63	CAP847204	2"	CAP849204	17 (27.2)	33.0	48.0	47.0	56.0	2.5	85	-	93.5
13	M75	CAP847394	2 1/2"	CAP849494	18 (40.5)	40.0	56.0	47.0	65.0	2.5	85	-	93.5
14	M75	CAP847304	2 1/2"	CAP849404	18 (40.5)	47.0	65.0	54.0	74.0	2.5	92	-	104.5
15	M90	CAP847794	3"	CAP849594	22 (42.0)	54.0	74.0	63.0	83.0	3.15	104	-	121.0
16	M90	CAP847504	3"	CAP849504	22 (42.0)	63.0	82.0	72.0	93.0	3.15	108	-	132.0
16	M90	CAP847574	3 1/2"	CAP849604	N/A (43.2)	63.0	82.0	72.0*	93.0*	3.15	108	-	132.0
17	M110	CAP847794	4"	CAP849704	22 (44.5)	72.0	92.0	85.0	107.0	3.15	115	-	148.5

All dimensions in millimeters unless otherwise noted * CAP849604 "outer sheath" min: 85 max: 107.

ADE 6F

International Standards - Flameproof and Increased Safety

ATEX
IECEX
cULus Listed for Class I, Zone 2
cULus Marine Listed for Class I,
Zone 2

CEPEL
GOST-R
NEPSI
NEMA 4X and IP68

4F

Gland Type:

Armoured

Cable Type:

Steel wire armoured, steel wire braided, steel tape armoured and braided marine shipboard

Certifications and Compliances:

- ATEX LCIE 97 6008X - Exd IIC / Exe II / Ex tD / Ex II 2GD
- IECEX LCI 05.0004X
- cULus Listed for Class I, Zone 2 AEx e II / Ex e II E310130
- cULus Marine Listed for Class I, Zone 2 AEx e II / Ex e II E314047
- NEMA 4X and IP68
- CEPEL
- GOST-R
- NEPSI

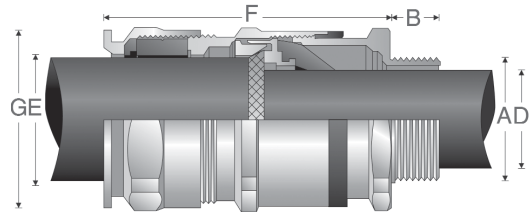

Features:

- Standard material is nickel-plated brass for superior corrosion resistance
- Armour clamping and bonding with no reversible components for easy installation, minimizing error
- Provides fully inspectable inner seal after installation
- Flameproof diaphragm seal on inner jacket does not damage cables exhibiting "cold-flow"; weatherproof seal on outer sheath of cable
- Deluge boot provides enhanced protection from water ingress
- Standard neoprene seal suitable for use in operating temperatures ATEX (-60°C to 100°C), IECEX and cULus (-40°C to 100°C)
- Available with metric or NPT threads
- See pages 96-103 for related accessories

ORDERING EXAMPLE:	OPTIONS (replace last digit with option number):
CAP96559 4	9 Stainless steel (316L) 8 Bronze
Gland Type	Options

SELECTION TABLE

Gland Size	Entry Thread Size 'A'				Thread Length 'B' Metric (NPT)	Cable Acceptance				Armour (max)	Gland Length 'F' (less entry)	Hexagon Dimensions	
	Metric Size	Metric Catalog #	NPT Size	NPT Catalog #		Inner Sheath 'D'		Outer Sheath 'E'				Across Flats	Across Corners 'G'
						Min	Max	Min	Max				
5	M16	CAP965594	3/8"	CAP967594	15 (12.0)	3.0	7.5	6.0	12.0	0.9	46.0	-	20.9
5	M20	CAP965674	1/2"	CAP967674	15 (20.2)	3.0	7.5	6.0	12.0	0.9	46.0	-	26.4
6	M20	CAP965694	1/2"	CAP967694	15 (20.2)	6.5	11.0	8.5	16.0	1.25	53.0	-	26.4
7	M20	CAP965604	1/2"	CAP967604	15 (20.2)	9.0	14.5	12.0	21.0	1.25	59.0	-	33.0
7	M25	CAP965794	3/4"	CAP967794	15 (20.2)	9.0	14.5	12.0	21.0	1.25	59.0	-	33.0
8	M25	CAP965704	3/4"	CAP967704	15 (20.2)	12.0	19.5	16.0	27.5	1.6	74.5	-	45.1
8	M32	CAP965894	1"	CAP967894	15 (25.3)	12.0	19.5	16.0	27.5	1.6	74.5	-	45.1
9	M32	CAP965804	1"	CAP967804	15 (25.3)	17.5	26.0	21.0	34.0	1.6	83.5	-	52.8
9	M40	CAP965994	1 1/4"	CAP967994	15 (26.0)	17.5	26.0	21.0	34.0	1.6	83.5	-	52.8
10	M40	CAP965904	1 1/4"	CAP967904	15 (26.0)	23.0	33.0	27.0	41.0	2.0	92.0	-	60.5
10	M50	CAP966094	1 1/2"	CAP968094	16 (26.5)	23.0	33.0	27.0	41.0	2.0	92.0	-	60.5
11	M50	CAP966004	2"	CAP968294	16 (27.2)	28.5	41.0	33.0	48.0	2.5	104.0	-	70.4

Larger sizes available in ADE 4F design, see page 72.
All dimensions in millimeters unless otherwise noted.

4F ADE 6FC

**International Standards -
Flameproof and Increased Safety**

ATEX
IECEX
cULus Listed for Class I, Zone 2
cULus Marine Listed for Class I, Div. 1

CEPEL
GOST-R
NEMA 4X and IP68

4F

Gland Type:

Armoured barrier

Cable Type:

Steel wire armoured, steel wire braided, steel tape armoured, braided marine shipboard and lead sheathed (with addition of earthing washer)

Certifications and Compliances:

- ATEX LCIE 97 ATEX 6008X - Exd IIC/Exe II/Ex tD/Ex II 2 GD
- IECEX LCI 05.0004X
- cULus Listed for Class I, Zone 2 AEx de II/Ex de II
- cULus Marine Listed for Class I, Division 1, Groups A, B, C, D
- NEMA 4X and IP68
- CEPEL-EX-558/05X
- GOST-R POCC FR Bo2011
- NEPSI N° GYJ071336U & GYJ071337U
- ABS approbation:
n° 10-HS 577243-PDA / P1836754-X
- DNV N° E-10892
- Lloyds

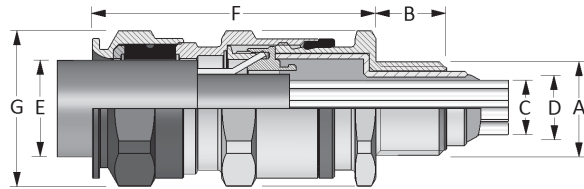

Features

- Standard material is nickel-plated brass for superior corrosion resistance
- Armour clamping with no reversible components for easy installation, minimizing error
- Provides explosionproof compound seal (denoted by red back nut) on conductors and weatherproof seal on outer sheath of cable
- Deluge boot provides enhanced protection from water ingress
- Standard neoprene seal suitable for use in operating temperatures -60°C (-25°C UL) to 80°C
- Available with metric or NPT threads
- See pages 96–103 for related accessories

ORDERING EXAMPLE:	OPTIONS (replace last digit with option number):
CAP96959 4 KX	9 Stainless steel (316L) 8 Bronze 7 Aluminum K1 Includes locknut and fiber washer K2 Includes locknut, fiber washer, earth tag, and shroud
Gland Type	Options

SELECTION TABLE

Gland Size	Entry Thread Size 'A'				Thread Length 'B' Metric (NPT)	Cable Acceptance						Armour (max)	Gland Length 'F' (less entry)	Hexagon Dimensions	
	Metric Size	Metric Catalog #	NPT Size	NPT Catalog #		Inner Sheath and Cores			Outer Sheath 'E'		Across Flats			Across Corners 'G'	
						Max Over Cores 'C'	Max Inner Sheath 'D'	Max No. of Cores	Min	Max					
5	M16	CAP969594	3/8"	CAP974594	15 (12.0)	6.5	7.5	6.0	6.0	12.0	0.9	46.0	-	20.9	
5	M20	CAP969674	1/2"	CAP971674	15 (20.2)	6.5	7.5	6.0	6.0	12.0	0.9	46.0	-	26.4	
6	M20	CAP969694	1/2"	CAP971694	15 (20.2)	9.5	11.0	6.0	8.5	16.0	1.25	53.0	-	26.4	
7	M20	CAP969604	1/2"	CAP971604	15 (20.2)	12.0	14.5	10.0	12.0	21.0	1.25	59.0	-	33.0	
7	M25	CAP969794	3/4"	CAP971794	15 (20.5)	12.0	14.5	10.0	12.0	21.0	1.25	59.0	-	33.0	
8	M25	CAP969704	3/4"	CAP971704	15 (20.5)	17.0	19.5	21.0	16.0	27.5	1.6	74.5	-	45.1	
8	M32	CAP969894	1"	CAP971894	15 (25.3)	17.0	19.5	21.0	16.0	27.5	1.6	74.5	-	45.1	
9	M32	CAP969804	1"	CAP971804	15 (25.3)	23.0	28.0	42.0	21.0	34.0	1.6	83.5	-	52.8	
9	M40	CAP969994	1 1/4"	CAP971994	15 (26.0)	23.0	28.0	42.0	21.0	34.0	1.6	83.5	-	52.8	
10	M40	CAP969904	1 1/4"	CAP971904	15 (26.0)	29.0	33.0	60.0	27.0	41.0	2.0	92.0	-	60.5	
10	M50	CAP970094	1 1/2"	CAP972094	16 (26.5)	29.0	33.0	60.0	27.0	41.0	2.0	92.0	-	60.5	
11	M50	CAP970004	1 1/2"	CAP972004	16 (27.2)	36.5	41.0	80.0	33.0	48.0	2.5	104.0	-	70.4	
12	M63	CAP970294	2"	CAP972274	17 (29.2)	43.0	48.0	100.0	40.0	56.0	2.5	108.0	-	79.2	
13	M63	CAP970204	2"	CAP972204	17 (29.2)	50.0	56.0	100.0	46.0	65.0	2.5	118.0	-	93.5	
13	M75	CAP970394	2 1/2"	CAP972494	18 (42.5)	50.0	56.0	100.0	46.0	65.0	2.5	118.0	-	93.5	
14	M75	CAP970304	2 1/2"	CAP972404	18 (42.5)	59.0	65.0	120.0	54.0	74.0	2.5	124.0	-	104.5	
14	-	-	3"	CAP972574	(44)	59.0	65.0	120.0	54.0	74.0	2.5	124.0	-	104.5	
15	M90	CAP970594	3"	CAP972594	22 (44.0)	66.0	73.0	140.0	63.0	83.0	3.15	133.0	-	121.0	
15	-	-	3 1/2"	CAP972694	(45.2)	66.0	73.0	140.0	63.0	83.0	3.15	133.0	-	121.0	
16	M90	CAP970504	3"	CAP972504	22 (44.0)	75.0	82.0	140.0	72.0	93.0	3.15	137.0	-	132.0	
16	-	-	3 1/2"	CAP972604	(45.2)	75.0	82.0**	140.0	72.0	93.0	3.15	137.0	-	132.0	
17	M110	CAP970794	4"	CAP972704	22 (46.5)	85.0	92.0**	200.0	85.0	107.0	3.15	142.0	-	148.5	

All dimensions in millimeters unless otherwise noted.

*Aluminum not currently available with UL marine certification.

**Contact Customer Service or your field sales representative for amended UL marine range.

Crouse-Hinds
by **E.T.N**

**International Standards -
Flameproof and Increased Safety**

Gland Type:

Non-armoured barrier

Cable Type:

Non-armoured, armoured and tray cable (does not terminate the armour)

Certifications and Compliances:

- LCIE 97 ATEX 6008X II GD - Exd IIC/Exe II/Ex tD
- IECEX LCI 05.0004X Ex c e IIC/Ex c e II/Ex tD
- cULus Listed for Class I, Zone 2 AEx de II/Ex de II
- UL Marine Listed for Class I, Division 2, Groups A, B, C, D
- NEMA 4X and IP68
- CEPEL EX-558/05X
- GOST-R POCC FR.B03126
- NEPSI N° GYJ071336U & GYJ071337U
- DNV N° E-10892
- ABS approbation:
n° 10-HS 577243-PDA / P1836754-X
- Lloyds

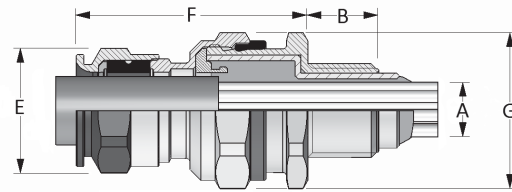

Features:

- Standard material is nickel-plated brass for superior corrosion resistance
- Provides a flameproof and weatherproof seal on outer sheath of cable
- Provides explosionproof compound seal (denoted by red back nut) on conductors
- Deluge boot provides enhanced protection from water ingress
- Standard neoprene seal suitable for use in operating temperatures -60°C (-25°C UL) to 80°C
- Available with metric or NPT threads
- See pages 96–103 for related accessories

ORDERING EXAMPLE:	OPTIONS (replace last digit with option number):				
<table border="1" style="margin: auto;"> <tr> <td style="padding: 5px;">CAP01959</td> <td style="padding: 5px;">4 KX</td> </tr> <tr> <td style="font-size: 8px;">Gland Type</td> <td style="font-size: 8px;">Options</td> </tr> </table>	CAP01959	4 KX	Gland Type	Options	9 Stainless steel (316L) 8 Bronze 7 Aluminum K1 Includes locknut and fiber washer K2 Includes locknut, fiber washer, earth tag, and shroud
CAP01959	4 KX				
Gland Type	Options				

SELECTION TABLE

Gland Size	Entry Thread Size 'A'				Thread Length 'B' Metric (NPT)	Cable Acceptance Outer Sheath 'E'		Max No. Cores	Gland Length 'F' (less entry)	Hexagon Dimensions	
	Metric Size	Metric Catalog #	NPT Size	NPT Catalog #		Min	Max			Across Flats	Across Corners 'G'
4	M16	CAP019594	3/8"	CAP011594	15 (12.0)	4.0	7.5	6.0	46.0	-	20.9
4	M20	CAP019674	1/2"	CAP011674	15 (22.2)	4.0	7.5	6.0	46.0	-	26.4
5	M20	CAP019694	1/2"	CAP011694	15 (22.2)	6.5	11.0	6.0	53.0	-	26.4
6	M20	CAP019604	1/2"	CAP011604	15 (22.2)	9.0	14.5	10.0	59.0	-	33.0
6	M25	CAP019794	3/4"	CAP011794	15 (22.5)	9.0	14.5	10.0	59.0	-	33.0
7	M25	CAP019704	3/4"	CAP011704	15 (22.5)	12.0	19.5	21.0	74.5	-	45.1
7	M32	CAP019894	1"	CAP011894	15 (27.3)	12.0	19.5	21.0	74.5	-	45.1
8	M32	CAP019804	1"	CAP011804	15 (27.3)	17.5	26.0	42.0	83.5	-	52.8
8	M40	CAP019994	1 1/4"	CAP011994	15 (28.0)	17.5	26.0	42.0	83.5	-	52.8
9	M40	CAP019904	1 1/4"	CAP011904	15 (28.0)	23.0	33.0	60.0	92.0	-	60.5
9	M50	CAP019094	1 1/2"	CAP011094	16 (28.5)	23.0	33.0	60.0	92.0	-	60.5
10	M50	CAP019004	2"	CAP011004	16 (29.2)	28.5	41.0	80.0	104.0	-	70.4
10	M63	CAP019204	-	-	16	28.5	41.0	80.0	-	-	73.7
11	M63	CAP019294	2"	CAP011294	17 (29.2)	43.0	48.0	100.0	98.0	-	70.4
12	M63	CAP019274	2"	CAP011204	17 (29.2)	50.0	56.0	100.0	103.0	-	79.2
12	-	-	2 1/2"	CAP011494	42.5	50.0	56.0	100.0	103.0	-	79.2
13	M75	CAP019304	2 1/2"	CAP011404	18 (42.5)	59.0	65.0	120.0	111.0	-	93.5
13	-	-	3"	CAP012504	44	59.0	65.0	120.0	111.0	-	93.5
14	M90	CAP010594	3"	CAP012574	22 (44.0)	66.0	73.0	140.0	120.0	-	104.5
14	-	-	3 1/2"	CAP012604	45.2	66.0	73.0	140.0	120.0	-	104.5
15	M90	CAP010504	3"	CAP012594	22 (44.0)	75.0	82.0	140.0	125.0	-	121.0
15	-	-	3 1/2"	CAP012694	45.2	75.0	82.0**	140.0	125.0	-	121.0
16	M110	CAP010794	4"	CAP012704	22 (46.5)	85.0	92.0**	200.0	128.0	-	132.0

All dimensions in millimeters unless otherwise noted.
 *Aluminum not currently available with UL marine certification.
 **Contact Customer Service or your field sales representative for amended UL marine range.



4F

Ex-e

**International Standards -
Flameproof and Increased Safety**

Sizes M12-M16: PTB 99 ATEX IP66
3101 X
Sizes M20-M63: PTB 99 ATEX
3128 X
IECEX

4F

Gland Type:

Non-armoured

Cable Type:

Non-armoured

Certifications and Compliances:

- Sizes M12-M16: PTB 99 ATEX 3101 X
Sizes M20-M63: PTB 99 ATEX 3128 X
Ex II 2 G Ex e II/Ex II 2 D Ex tD A21
- IECEX PTB 05.0004X
- IP66

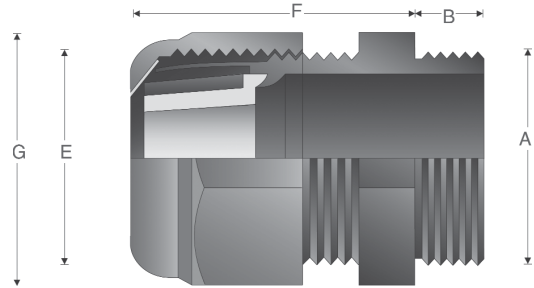

Features:

- Standard material is high-impact resistant polyamide
- Forms weatherproof seal on outer sheath of cable
- Standard silicone seal suitable for use in operating temperatures -55° to 70°C (M12 and M16 for use in operating temperatures -20° to 70°C)
- Available with optional silicone seal for extreme temperatures
- Available with metric threads
- See page 101 for related accessories

SELECTION TABLE - SHORT THREAD

Gland Size	Entry Thread Size 'A'		Thread Length 'B' Metric	Cable Acceptance Outer Sheath 'E'		Gland Length 'F' (less entry)	Hexagon Dimensions	
	Metric Size	Metric Catalog #		Min	Max		Across Flats	Across Corners 'G'
16	M16	GHG 960 1955 R 0002	8.0	5.5	10.0	23.0	20.0	22.0
20	M20	GHG 960 1955 R 0003	8.0	5.5	13.0	25.0	24.0	26.4
25	M25	GHG 960 1955 R 0004	8.0	8.0	17.0	29.5	29.0	31.9
32	M32	GHG 960 1955 R 0005	10.0	12.0	21.0	35.5	36.0	39.6

SELECTION TABLE - LONG THREAD

Gland Size	Entry Thread Size 'A'		Thread Length 'B' Metric	Cable Acceptance Outer Sheath 'E'		Gland Length 'F' (less entry)	Hexagon Dimensions	
	Metric Size	Metric Catalog #		Min	Max		Across Flats	Across Corners 'G'
16	M16	GHG 960 1955 R 0022	8.0	5.5	10.0	23.0	20.0	22.0
20	M20	GHG 960 1955 R 0023	8.0	5.5	13.0	25.0	24.0	26.4
25	M25	GHG 960 1955 R 0024	8.0	8.0	27.0	29.5	29.0	31.9
32	M32	GHG 960 1955 R 0025	10.0	12.0	21.0	35.5	36.0	39.6
40	M40	GHG 960 1955 R 0026	15.0	17.0	28.0	39.5	46.0	50.6
50	M50	GHG 960 1955 R 0027	16.0	22.0	35.0	44.0	55.0	60.5
63	M63	GHG 960 1955 R 0028	16.0	27.0	48.0	47.0	68.0	74.8

All dimensions in millimeters unless otherwise noted.

Ex-i

International Standards - Flameproof and Increased Safety

Sizes M12-M16: PTB 99 ATEX IP66
3101 X
Sizes M20-M63: PTB 99 ATEX
3128 X
IECEX

4F

4F

Gland Type:

Non-armoured

Cable Type:

Non-armoured

Certifications and Compliances:

- Sizes M12-M16: PTB 99 ATEX 3101 X
Sizes M20-M63: PTB 99 ATEX 3128 X
Ex II 2 G Ex e II/Ex II 2 D Ex tD A21
- IECEX PTB 05.0004X
- IP66

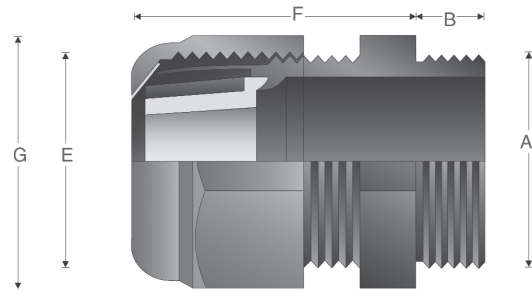

Features:

- Standard material is high-impact resistant polyamide (gland nut is blue for intrinsically safe circuits)
- Forms weatherproof seal on outer sheath of cable
- Standard silicone seal suitable for use in operating temperatures -55° to 70°C (M12 and M16 for use in operating temperatures -20° to 70°C)
- Available with metric threads
- See page 101 for related accessories

SELECTION TABLE – SHORT THREAD

Gland Size	Entry Thread Size 'A'		Thread Length 'B' Metric	Cable Acceptance		Gland Length 'F' (less entry)	Hexagon Dimensions	
	Metric Size	Metric Catalog #		Outer Sheath 'E'			Across Flats	Across Corners 'G'
				Min	Max			
12	M12	GHG 960 1955 R 0101	8.0	4.0	7.0	19.3	15.0	16.5
16	M16	GHG 960 1955 R 0102	8.0	5.5	10.0	23.0	20.0	22.0
20	M20	GHG 960 1955 R 0103	8.0	5.5	13.0	25.0	24.0	26.4
25	M25	GHG 960 1955 R 0104	8.0	8.0	17.0	29.5	29.0	31.9
32	M32	GHG 960 1955 R 0105	10.0	12.0	21.0	35.5	36.0	39.6

SELECTION TABLE – LONG THREAD

Gland Size	Entry Thread Size 'A'		Thread Length 'B' Metric	Cable Acceptance		Gland Length 'F' (less entry)	Hexagon Dimensions	
	Metric Size	Metric Catalog #		Outer Sheath 'E'			Across Flats	Across Corners 'G'
				Min	Max			
12	M12	GHG 960 1955 R 0121	12.0	4.0	7.0	19.3	15.0	16.5
16	M16	GHG 960 1955 R 0122	12.0	5.5	10.0	23.0	20.0	22.0
20	M20	GHG 960 1955 R 0123	13.0	5.5	13.0	25.0	24.0	26.4
25	M25	GHG 960 1955 R 0124	13.0	8.0	17.0	29.5	29.0	31.9
32	M32	GHG 960 1955 R 0125	15.0	12.0	21.0	35.5	36.0	39.6
40	M40	GHG 960 1955 R 0126	15.0	17.0	28.0	39.5	46.0	50.6
50	M50	GHG 960 1955 R 0127	16.0	22.0	35.0	44.0	55.0	60.5
63	M63	GHG 960 1955 R 0128	16.0	27.0	48.0	47.0	68.0	74.8

All dimensions in millimeters unless otherwise noted.

**International Standards -
Flameproof and Increased Safety**

4F

Gland Type:

Non-armoured

Cable Type:

Non-armoured

Certifications and Compliances:

- ATEX PTB 00ATEX3121X Ex II 2 G Ex e II/Ex II 2 D Ex tD A21
- IP66

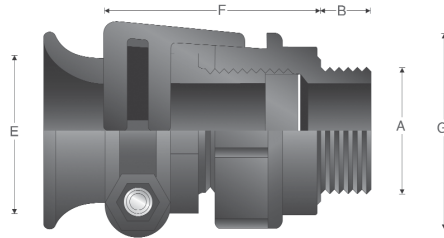

Features:

- Standard material is high-impact resistant polyamide
- Forms weatherproof seal on outer sheath of cable
- Flared rear seal provides protection for cable
- Standard neoprene seal suitable for use in operating temperatures -40° to 85°C
- Available with metric threads
- See page 101 for related accessories

SELECTION TABLE

Gland Size	Entry Thread Size 'A'		Thread Length 'B' Metric	Cable Acceptance		Gland Length 'F' (less entry)	Hexagon Dimensions	
	Metric Size	Metric Catalog #		Outer Sheath 'E'			Across Flats	Across Corners 'G'
				Min	Max			
20	M20	GHG 960 1949 R0111	15.0	8.0	13.0	49.0	26.0	28.6
25	M25	GHG 960 1949 R0112	15.0	11.0	16.0	50.0	32.0	35.2
32	M32	GHG 960 1949 R0113	15.0	15.0	20.0	65.0	41.0	45.1
40	M40	GHG 960 1949 R0114	15.0	19.0	27.0	71.0	50.0	55.0
50	M50	GHG 960 1949 R0115	16.0	26.0	34.0	79.0	60.0	66.0
60	M60	GHG 960 1949 R0116	16.0	35.0	46.0	89.0	75.0	82.5

All dimensions in millimeters unless otherwise noted.

Enlargement and Multiple

International Standards - Flameproof and Increased Safety

Sizes M16: PTB 99 ATEX 3101 X
 Sizes M20-M63: PTB 99 ATEX
 3128 X
 IECEx

IP66

4F

4F

Gland Type:

Non-armoured

Cable Type:

Non-armoured

Certifications and Compliances:

- Sizes M16: PTB 99 ATEX 3101 X
 Sizes M20-M63: PTB 99 ATEX 3128 X
 Ex II 2 G Ex e II/Ex II 2 D Ex tD A21
- IECEx PTB 05.0004X
- IP66

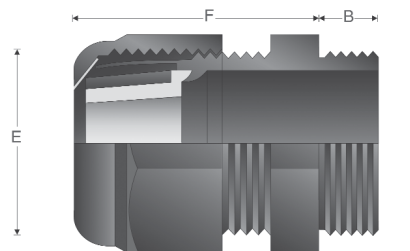

Features:

- Standard material is high-impact resistant polyamide
- Forms weatherproof seal on outer sheath of cable
- Provides reduced entry threads for larger gland size
- Standard silicone seal suitable for use in operating temperatures -55° to 70°C (M16 for use in operating temperatures -20° to 70°C)
- Available with metric threads
- See page 101 for related accessories

SELECTION TABLE – ENLARGEMENT

Gland Size	Entry Thread Size 'A'		Thread Length 'B' Metric	Cable Acceptance Outer Sheath 'E'		Gland Length 'F' (less entry)	Hexagon Dimensions	
	Metric Size	Metric Catalog #		Min	Max		Across Flats	Across Corners 'G'
20/25	M20	GHG 960 1956 R0003	13.0	8.0	17.0	29.5	29.0	31.9
25/32	M25	GHG 960 1956 R0004	13.0	12.0	21.0	35.5	36.0	39.6
32/40	M32	GHG 960 1956 R0005	15.0	16.0	28.0	39.5	46.0	50.6
40/50	M40	GHG 960 1956 R0006	15.0	21.0	35.0	44.0	55.0	60.5
50/63	M50	GHG 960 1956 R0007	16.0	27.0	48.0	47.0	68.0	74.8

SELECTION TABLE – MULTIPLE

Gland Size	Entry Thread Size 'A'		Thread Length 'B' Metric	Cable Acceptance Outer Sheath 'E'		Maximum Number of Conductors	Gland Length 'F' (less entry)	Hexagon Dimensions	
	Metric Size	Metric Catalog #		Min	Max			Across Flats	Across Corners 'G'
32	M32	GHG 960 1955 R0055	10.0	4.5	7.0	4	39.5	46.0	50.6

All dimensions in millimeters unless otherwise noted.

International Standards - Industrial

4F

Gland Type:

Armoured

Cable Type:

Steel wire armoured, steel wire braided, steel tape armoured, braided marine shipboard lead sheathed (with addition of earthing washer) and tray cable

Certifications and Compliances:

- NEMA 4X and IP68

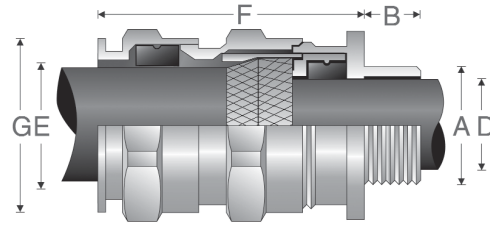

Features:

- Standard material is nickel-plated brass for superior corrosion resistance
- Armour clamping and bonding with no reversible components for easy installation, minimizing error
- Provides seal on inner jacket and weatherproof seal on outer sheath of the cable
- An optional earthing washer for use with lead sheathed cable (see page 97)
- Standard neoprene seal suitable for use in operating temperatures of -60°C to 100°C
- Available with optional silicone seal for extreme temperatures
- Available with metric or NPT threads
- See pages 96–103 for related accessories

ORDERING EXAMPLE:	OPTIONS (replace last digit with option number):
CAP94640 4	9 Stainless steel (316L)
	8 Bronze
	7 Aluminum
	5 Silicone sealing ring with temperature range of -70° C to 220° C
Gland Type	Options
Available in stainless steel – contact customer service	

SELECTION TABLE

Gland Size	Entry Thread Size 'A'				Thread Length 'B' Metric (NPT)	Cable Acceptance				Armour (max)	Gland Length 'F' (less entry)	Hexagon Dimensions	
	Metric Size	Metric Catalog #	NPT Size	NPT Catalog #		Inner Sheath 'D'		Outer Sheath 'E'				Across Flats	Across Corners 'G'
						Min	Max	Min	Max				
5	M12	CAP946404	1/4"	CAP948404	15 (12.0)	4.0	8.0	6.0	12.0	0.9	36.0	–	20.9
5	M16	CAP946594	3/8"	CAP948594	15 (12.0)	4.0	8.5	6.0	12.0	0.9	36.0	–	20.9
6	M16	CAP946504	3/8"	CAP948504	15 (12.0)	6.0	12.0	8.5	16.0	1.25	42.0	–	26.4
5	M20	CAP946674	1/2"	CAP948674	15 (20.2)	4.0	8.5	6.0	12.0	0.9	36.0	–	26.4
6	M20	CAP946694	1/2"	CAP948694	15 (20.2)	6.0	12.0	8.5	16.0	1.25	42.0	–	26.4
7	M20	CAP946604	1/2"	CAP948604	15 (20.2)	8.5	16.0	12.0	21.0	1.25	46.0	–	33.0
6	M25	CAP946774	3/4"	CAP948774	15 (20.2)	6.0	12.0	8.5	16.0	1.25	42.0	–	33.0
7	M25	CAP946794	3/4"	CAP948795	15 (20.2)	8.5	16.0	12.0	21.0	1.25	46.0	–	33.0
8	M25	CAP946704	3/4"	CAP948704	15 (20.2)	12.0	20.5	16.0	27.5	1.6	56.0	–	45.1
8	M32	CAP946894	1"	CAP948894	15 (25.3)	12.0	21.0	16.0	27.5	1.6	56.0	–	45.1
9	M32	CAP946804	1"	CAP948804	15 (25.3)	16.0	27.5	21.0	34.0	1.6	63.0	–	52.8
9	M40	CAP946994	1 1/4"	CAP948994	15 (26.0)	16.0	27.5	21.0	34.0	1.6	63.0	–	52.8
10	M40	CAP946904	1 1/4"	CAP948904	15 (26.0)	21.0	34.0	27.0	41.0	2.0	68.0	–	60.5
10	M50	CAP947094	1 1/2"	CAP949904	16 (26.5)	21.0	34.0	27.0	41.0	2.0	68.0	–	60.5
11	M50	CAP947004	1 1/2"	CAP949004	16 (26.5)	27.0	41.0	33.0	48.0	2.5	74.0	–	70.4
12	M63	CAP947294	2"	CAP949294	17 (27.2)	27.0	41.0	33.0	48.0	2.5	77.0	–	79.2
13	M63	CAP947204	2"	CAP949204	17 (27.2)	33.0	48.0	40.0	56.0	2.5	85.0	–	93.5
13	M75	CAP947394	2 1/2"	CAP949949	18 (40.5)	40.0	56.0	47.0	65.0	2.5	85.0	–	93.5
14	M75	CAP947304	2 1/2"	CAP949404	18 (40.5)	47.0	65.0	54.0	74.0	2.5	92.0	–	104.5
15	M90	CAP947594	3"	CAP949564	22 (42.0)	54.0	74.0	63.0	83.0	3.15	104.0	–	121.0
16	M90	CAP947504	3"	CAP949504	22 (42.0)	63.0	82.0	72.0	93.0	3.15	108.0	–	132.0
16	–	–	3 1/2"	CAP949604	– (43.2)	63.0	82.0	72.0	93.0	3.15	108.0	–	132.0
17	M110	CAP947794	4"	CAP949704	22 (44.5)	72.0	92.0	85.0	107.0	3.15	115.0	–	148.5

All dimensions in millimeters unless otherwise noted.

Terminator™ II TMCX

North American Standards -
Explosionproof

UL/cULus Listed
Cl. I, Div. 1, Groups A, B, C, D
Cl. II, Groups E, F, G
Cl. III

NEMA 6P
IECEX/ATEX (Pending)

4F

Gland Type:

Armoured barrier, TECK armoured, and non-armoured barrier

Cable Type:

Metal-clad and TECK (interlocked and continuously welded corrugated armoured), unarmoured, and tray cable

Certifications and Complies:

- Class I, Division 1, Groups A, B, C, D
- Class II, Groups E, F, G
- Class III
- NEMA 6P
- UL/cULus Listed - File No. E122485
- IECEX/ATEX (Pending)

Features:

- Designed to minimize the opportunity for incorrect assembly
- Simple selection process and field preparation aids to ensure the right gland is selected every time
- Full coverage of all popular cables and hub sizes, ensuring a perfect seal in all instances
- Use of nickel-plated brass and stainless steel to increase corrosion resistance and maintain integrity in the harshest environments
- Chico® LiquidSeal, an innovative liquid compound with fast gel and cure times, reduces waiting times
- Complete with integral dam to facilitate liquid pour
- Integral union design reduces the number of times the gland has to be assembled and disassembled during installation

- Mating components have generous lead-ins to ensure that assembly is as trouble-free as possible, even with the heaviest cables
- Use of neoprene seal allows use in temperatures from -40°C to +60°C; for specific temperature information, please contact your local sales representative
- Metric size threads allow interfacing to European machinery
- Wide range of global certifications and approvals
- See page 102 for related accessories



SELECTION TABLE

Entry Thread 'C'	NPT Catalog #	Entry Thread 'C' (Metric Option)	Metric Catalog #	Over Conductors O.D. Max. Inches 'G'	'A' Armour O.D.		'B' Cable O.D.†		Across Corners 'D'	Thread Length NPT 'E' (Metric mm.)	Length 'F'
					Min.	Max.	Min.	Max.			
1/2"	TMCX050 1	M20	TMCXM20 1	0.480	0.40 (10.16)	0.86 (21.84)	0.49 (12.45)	0.90 (22.86)	1.75 (44.45)	1.00 (25.40)	3.05 (77.47)
1/2"	TMCX050 2	M20	TMCXM20 2	0.480	0.56 (14.22)	1.14 (28.96)	0.65 (16.51)	1.18 (29.97)	2.25 (57.15)	1.00 (25.40)	3.18 (80.77)
3/4"	TMCX075 1	M25	TMCXM25 1	0.713	0.40 (10.16)	0.86 (21.84)	0.49 (12.45)	0.90 (22.86)	1.75 (44.45)	1.00 (25.40)	3.05 (77.47)
3/4"	TMCX075 2	M25	TMCXM25 2	0.713	0.56 (14.22)	1.14 (28.96)	0.65 (16.51)	1.18 (29.97)	2.25 (57.15)	1.00 (25.40)	3.18 (80.77)
1"	TMCX100 1	M32	TMCXM32 1	0.939	0.56 (14.22)	1.14 (28.96)	0.65 (16.51)	1.18 (29.97)	2.25 (57.15)	1.08 (27.40)	3.18 (80.77)
1"	TMCX100 2	M32	TMCXM32 2	0.939	0.78 (19.81)	1.35 (34.29)	0.87 (22.10)	1.39 (35.31)	2.56 (65.02)	1.08 (27.40)	3.30 (83.82)
1 1/4"	TMCX125 1	M40	TMCXM40 1	1.172	0.78 (19.81)	1.35 (34.29)	0.87 (22.10)	1.39 (35.31)	2.56 (65.02)	1.08 (27.40)	3.30 (83.82)

All dimensions in inches; metric millimeters shown in parenthesis. Sizes 1 1/2" and above will be available soon.

†When making your cable gland selection based on Cable O.D., be sure to also observe the Over Conductors O.D. dimension.

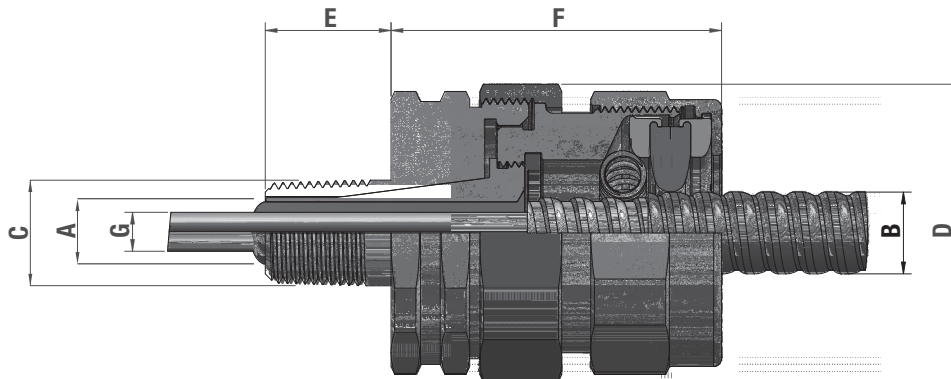

4F Terminator™ II TMCX

North American Standards -
Explosionproof

UL/cULus Listed
Cl. I, Div. 1, Groups A, B, C, D
Cl. II, Groups E, F, G
Cl. III

NEMA 6P
IECEX/ATEX (Pending)

4F

Catalog Numbering System:

TMCX

050

1

NP

L

Hub Size

NPT	Hub (in.)	Metric	Hub (mm.)
050	½"	M20	20
075	¾"	M25	25
100	1"	M32	32
125	1-¼"	M40	40

Cable Sealing Range

Hub Size Code	Thread		Sealing Range Code	Standard Cable Sealing Range
050	½"	NPT	1	0.49" - 0.90"
			2	0.65" - 1.18"
075	¾"	NPT	1	0.49" - 0.90"
			2	0.65" - 1.18"
100	1"	NPT	1	0.65" - 1.18"
			2	0.87" - 1.39"
125	1-¼"	NPT	1	0.87" - 1.39"
M20	M20	ISO	1	12.4 mm - 22.8 mm
			2	16.5 mm - 29.9 mm
M25	M25	ISO	1	12.4 mm - 22.8 mm
			2	16.5 mm - 29.9 mm
M32	M32	ISO	1	16.5 mm - 29.9 mm
			2	22.0 mm - 35.3 mm
M40	M40	ISO	1	22.0 mm - 35.3 mm

Material

BLANK	Aluminum
SS	316 Stainless Steel
NP	Nickel-plated Brass

Compound Type

BLANK	TSC
L	Liquid

**North American Standards -
 Explosionproof**

Gland Type:

Armoured barrier, TECK armoured and non-armoured barrier

Cable Type:

Metal-clad (interlocked or continuously welded corrugated armoured), non-armoured and tray cable

Certifications and Compliances:

- UL Listed, CSA Certified Class I, Div. 1, Groups, A, B, C, D; Class II; Class III – UL File E122485, CSA File LR13046
- NEMA 4 and IP56 rated
- Wet locations

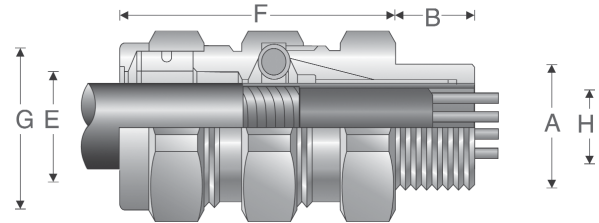

Features:

- Standard material is aluminum
- Stainless steel copper-plated spring provides grounding continuity of cable armour (MC cable only)
- Provides explosionproof compound seal on conductors and watertight seal on outer sheath of cable
- Standard neoprene seal suitable for use in operating temperatures -25° to 60°C
- Cold Shrink™ Kit is available for extra protection in aggressive environments (see page 102)
- Available with NPT threads
- See page 102 for related accessories

ORDERING EXAMPLE:		OPTIONS (add after gland type):	
TMCX165 -BR		-BR Brass construction (i.e.,TMCX285-BR)	
		-NP Nickel-plate finish (i.e.,TMCX285-BR-NP)	
Gland Type	Options		

SELECTION TABLE

Entry Thread Size 'A'		Thread Length 'B' NPT	Cable Acceptance				Gland Length 'F' (less entry)	Hexagon Dimensions	
NPT Size	NPT Catalog #		Armour Range 'H'		Outer Sheath 'E'			Across Flats	Across Corners 'G'
			Min	Max	Min	Max			
1/2"	TMCX165	0.750	0.440	0.650	0.490	0.781	2.625	1.250	1.375
3/4"	TMCX285	0.781	0.600	0.850	0.650	1.000	2.875	1.500	1.625
1"	TMCX3112	0.938	0.800	1.120	0.850	1.313	3.125	1.875	2.000
1 1/4"	TMCX4140	0.969	1.100	1.400	1.150	1.625	3.125	2.250	2.438
1 1/2"	TMCX5161	0.969	1.330	1.610	1.380	1.781	3.375	2.500	2.750
2"	TMCX6206	1.000	1.570	2.060	1.630	2.313	5.313	3.250	3.500
2 1/2"	TMCX7247	1.438	1.930	2.470	1.990	2.719	6.063	3.750	4.000
3"	TMCX8302	1.438	2.450	3.020	2.525	3.281	6.063	4.500	4.875
3 1/2"	TMCX9352	1.625	2.950	3.520	3.025	3.781	7.750	5.000	5.375
4"	TMCX10402	1.625	3.500	4.020	3.585	4.281	8.313	5.500	5.875

All dimensions in inches unless otherwise noted.

4F ADE 6FC

North American Standards - Explosionproof

ATEX
IECEX
cULus Listed for Class I, Zone 2
cULus Marine Listed for Class I, Div. 1

CEPEL
GOST-R
NEMA 4X and IP68

4F

Gland Type:

Armoured barrier

Cable Type:

Steel wire armoured, steel wire braided, steel tape armoured, braided marine shipboard and lead sheathed (with addition of earthing washer)

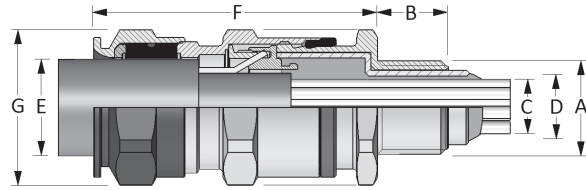

Certifications and Compliances:

- ATEX LCIE 97 ATEX 6008X - Exd IIC/Exe II/Ex tD/Ex II 2 GD
- IECEX LCI 05.0004X
- cULus Listed for Class I, Zone 2 AEx de II/Ex de II
- cULus Marine Listed for Class I, Division 1, Groups A, B, C, D
- NEMA 4X and IP68
- CEPEL-EX-558/05X
- GOST-R POCC FR Bo2011
- NEPSI N° GYJ071336U & GYJ071337U
- ABS approbation:
n° 10-HS 577243-PDA / P1836754-X
- DNV N° E-10892
- Lloyds

Features:

- Standard material is nickel-plated brass for superior corrosion resistance
- Armour clamping with no reversible components for easy installation, minimizing error
- Provides explosionproof compound seal (denoted by red back nut) on conductors and weatherproof seal on outer sheath of cable
- Deluge boot provides enhanced protection from water ingress
- Standard neoprene seal suitable for use in operating temperatures -60°C (-25°C UL) to 80°C
- Available with metric or NPT threads
- See pages 96-99 for related accessories

ORDERING EXAMPLE:

CAP96959 4 KX

Gland Type

Options

OPTIONS (replace last digit with option number):

- 9 Stainless steel (316L)
- 8 Bronze
- 7 Aluminum
- K1 Includes locknut and fiber washer
- K2 Includes locknut, fiber washer, earth tag, and shroud

SELECTION TABLE

Gland Size	Entry Thread Size 'A'				Thread Length 'B' Metric (NPT)	Cable Acceptance					Armour (max)	Gland Length 'F' (less entry)	Hexagon Dimensions	
	Metric Size	Metric Catalog #	NPT Size	NPT Catalog #		Inner Sheath and Cores			Outer Sheath 'E'				Across Flats	Across Corners 'G'
						Max Over Cores 'C'	Max Inner Sheath 'D'	Max No. of Cores	Min	Max				
5	M16	CAP969594	3/8"	CAP974594	15 (12.0)	6.5	7.5	6.0	6.0	12.0	0.9	46.0	-	20.9
5	M20	CAP969674	1/2"	CAP971674	15 (20.2)	6.5	7.5	6.0	6.0	12.0	0.9	46.0	-	26.4
6	M20	CAP969694	1/2"	CAP971674	15 (20.2)	9.5	11.0	6.0	8.5	16.0	1.25	53.0	-	26.4
7	M20	CAP969604	1/2"	CAP971604	15 (20.2)	12.0	14.5	10.0	12.0	21.0	1.25	59.0	-	33.0
7	M25	CAP969794	3/4"	CAP971794	15 (20.5)	12.0	14.5	10.0	12.0	21.0	1.25	59.0	-	33.0
8	M25	CAP969704	3/4"	CAP971704	15 (20.5)	17.0	19.5	21.0	16.0	27.5	1.6	74.5	-	45.1
8	M32	CAP969894	1"	CAP971894	15 (25.3)	17.0	19.5	21.0	16.0	27.5	1.6	74.5	-	45.1
9	M32	CAP969804	1"	CAP971804	15 (25.3)	23.0	28.0	42.0	21.0	34.0	1.6	83.5	-	52.8
9	M40	CAP969994	1 1/4"	CAP971994	15 (26.0)	23.0	28.0	42.0	21.0	34.0	1.6	83.5	-	52.8
10	M40	CAP969904	1 1/4"	CAP971904	15 (26.0)	29.0	33.0	60.0	27.0	41.0	2.0	92.0	-	60.5
10	M50	CAP970094	1 1/2"	CAP972094	16 (26.5)	29.0	33.0	60.0	27.0	41.0	2.0	92.0	-	60.5
11	M50	CAP970004	1 1/2"	CAP972004	16 (27.2)	36.5	41.0	80.0	33.0	48.0	2.5	104.0	-	70.4
12	M63	CAP970294	2"	CAP972274	17 (29.2)	43.0	48.0	100.0	40.0	56.0	2.5	108.0	-	79.2
13	M63	CAP970204	2"	CAP972204	17 (29.2)	50.0	56.0	100.0	46.0	65.0	2.5	118.0	-	93.5
13	M75	CAP970394	2 1/2"	CAP972494	18 (42.5)	50.0	56.0	100.0	46.0	65.0	2.5	118.0	-	93.5
14	M75	CAP970304	2 1/2"	CAP972404	18 (42.5)	59.0	65.0	120.0	54.0	74.0	2.5	124.0	-	104.5
14	-	-	3"	CAP972574	(44)	59.0	65.0	120.0	54.0	74.0	2.5	124.0	-	104.5
15	M90	CAP970594	3"	CAP972594	22 (44.0)	66.0	73.0	140.0	63.0	83.0	3.15	133.0	-	121.0
15	-	-	3 1/2"	CAP972694	(45.2)	66.0	73.0	140.0	63.0	83.0	3.15	133.0	-	121.0
16	M90	CAP970504	3"	CAP972504	22 (44.0)	75.0	82.0	140.0	72.0	93.0	3.15	137.0	-	132.0
16	-	-	3 1/2"	CAP972604	(45.2)	75.0	82.0**	140.0	72.0	93.0	3.15	137.0	-	132.0
17	M110	CAP970794	4"	CAP972704	22 (46.5)	85.0	92.0**	200.0	85.0	107.0	3.15	142.0	-	148.5

All dimensions in millimeters unless otherwise noted.

*Aluminum not currently available with UL marine certification.

**Contact Customer Service or your field sales representative for amended UL marine range.

**North American Standards -
Explosionproof**

Gland Type:

Non-armoured barrier

Cable Type:

Non-armoured, armoured and tray cable (does not terminate the armour)

Certifications and Compliances:

- LCIE 97 ATEX 6008X II GD - Exd IIC/Exe II/Ex tD
- IECEX LCI 05.0004X Ex c e IIC/Ex c e II/Ex tD
- cULus Listed for Class I, Zone 2 AEx de II/Ex de II
- UL Marine Listed for Class I, Division 2, Groups A, B, C, D
- NEMA 4X and IP68
- CEPEL EX-558/05X
- GOST-R POCC FR.B03126
- NEPSI N° GYJ071336U & GYJ071337U
- DNV N° E-10892
- ABS approbation:
n° 10-HS 577243-PDA / P1836754-X
- Lloyds

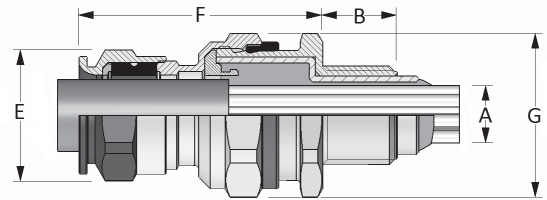

Features:

- Standard material is nickel-plated brass for superior corrosion resistance
- Provides a flameproof and weatherproof seal on outer sheath of cable
- Provides explosionproof compound seal (denoted by red back nut) on conductors
- Deluge boot provides enhanced protection from water ingress
- Standard neoprene seal suitable for use in operating temperatures -60°C (-25°C UL) to 80°C
- Available with metric or NPT threads
- See pages 96–99 for related accessories

ORDERING EXAMPLE:	OPTIONS (replace last digit with option number):
<div style="border: 1px solid black; padding: 5px; display: inline-block;"> CAP01959 4 KX </div>	<ul style="list-style-type: none"> 9 Stainless steel (316L) 8 Bronze 7 Aluminum K1 Includes locknut and fiber washer K2 Includes locknut, fiber washer, earth tag, and shroud
Gland Type	Options

SELECTION TABLE

Gland Size	Entry Thread Size 'A'				Thread Length 'B' Metric (NPT)	Cable Acceptance		Max No. Cores	Gland Length 'F' (less entry)	Hexagon Dimensions	
	Metric Size	Metric Catalog #	NPT Size	NPT Catalog #		Outer Sheath 'E'				Across Flats	Across Corners 'G'
						Min	Max				
4	M16	CAP019594	3/8"	CAP011594	15 (12.0)	4.0	7.5	6.0	46.0	–	20.9
4	M20	CAP019674	1/2"	CAP011674	15 (22.2)	4.0	7.5	6.0	46.0	–	26.4
5	M20	CAP019694	1/2"	CAP011694	15 (22.2)	6.5	11.0	6.0	53.0	–	26.4
6	M20	CAP019604	1/2"	CAP011604	15 (22.2)	9.0	14.5	10.0	59.0	–	33.0
6	M25	CAP019794	3/4"	CAP011794	15 (22.5)	9.0	14.5	10.0	59.0	–	33.0
7	M25	CAP019704	3/4"	CAP011704	15 (22.5)	12.0	19.5	21.0	74.5	–	45.1
7	M32	CAP019894	1"	CAP011894	15 (27.3)	12.0	19.5	21.0	74.5	–	45.1
8	M32	CAP019804	1"	CAP011804	15 (27.3)	17.5	26.0	42.0	83.5	–	52.8
8	M40	CAP019994	1 1/4"	CAP011994	15 (28.0)	17.5	26.0	42.0	83.5	–	52.8
9	M40	CAP019904	1 1/4"	CAP011904	15 (28.0)	23.0	33.0	60.0	92.0	–	60.5
9	M50	CAP019094	1 1/2"	CAP011094	16 (28.5)	23.0	33.0	60.0	92.0	–	60.5
10	M50	CAP019004	2"	CAP011004	16 (29.2)	28.5	41.0	80.0	104.0	–	70.4
10	M63	CAP019204	–	–	16	28.5	41.0	80.0	–	–	73.7
11	M63	CAP019294	2"	CAP011294	17 (29.2)	43.0	48.0	100.0	98.0	–	70.4
12	M63	CAP019274	2"	CAP011204	17 (29.2)	50.0	56.0	100.0	103.0	–	79.2
12	–	–	2 1/2"	CAP011494	42.5	50.0	56.0	100.0	103.0	–	79.2
13	M75	CAP019304	2 1/2"	CAP011404	18 (42.5)	59.0	65.0	120.0	111.0	–	93.5
13	–	–	3"	CAP012504	44	59.0	65.0	120.0	111.0	–	93.5
14	M90	CAP010594	3"	CAP012574	22 (44.0)	66.0	73.0	140.0	120.0	–	104.5
14	–	–	3 1/2"	CAP012604	45.2	66.0	73.0	140.0	120.0	–	104.5
15	M90	CAP010504	3"	CAP012594	22 (44.0)	75.0	82.0	140.0	125.0	–	121.0
15	–	–	3 1/2"	CAP012694	45.2	75.0	82.0**	140.0	125.0	–	121.0
16	M110	CAP010794	4"	CAP012704	22 (46.5)	85.0	92.0**	200.0	128.0	–	132.0

All dimensions in millimeters unless otherwise noted.
*Aluminum not currently available with UL marine certification.
**Contact Customer Service or your field sales representative for amended UL marine range.

4F**CGBS and EBY****North American Standards -
Explosionproof**

CGBS:
 CSA Certified Class I,
 Div. 1, Groups C, D
 Class II, Div. 1 & 2, Groups E, F, G
 Class III

EBY:
 UL, cUL Listed Class I,
 Div. 1, Groups B, C, D
 Class II, Div. 1, Groups F, G

4F**Gland Type:**

Portable cord connector

Cable Type:

Non-armoured and tray cable

Certifications and Compliances:

- CSA Certified Class I, Div. 1, Groups C, D
- Class II, Div. 1 & 2, Groups E, F, G
- Class III – CSA File LR13046

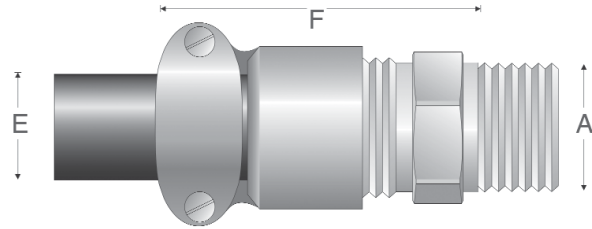
**CGBS Features:**

- Body – steel with zinc electroplate and chromate finish coat
- Gland nut – aluminum
- Body well for Chico A sealing compound (for ordering information please contact customer service)
- Standard neoprene seal suitable for use in operating temperatures -25° to 40°C
- Available with NPT threads

SELECTION TABLE

Entry Thread Size 'A'		Form	Outer Sheath 'E'		Gland Length 'F' (less entry)
NPT Size	NPT Catalog #		Min	Max	
1/2"	CGBS1013	A	0.312	0.437	5/4"
3/4"	CGBS2013	A	0.312	0.437	5/4"
3/4"	CGBS2014	A	0.375	0.500	5/4"
1"	CGBS3015	B	0.500	0.625	27/8"
1"	CGBS3016	B	0.625	0.750	215/16"
1 1/4"	CGBS4017	B	0.750	0.875	213/16"
1 1/4"	CGBS4018	B	0.875	1.000	3 1/2"
1 1/2"	CGBS4019	B	1.000	1.188	3 7/16"

All dimensions in inches unless otherwise noted.

Gland Type:

Portable cord connector

Cable Type:

Non-armoured

Certifications and Compliances:

- UL, cUL Listed Class I, Div. 1, Groups B, C, D
- Class II, Div. 1, Groups F, G – UL File E10279

SELECTION TABLE

Entry Thread Size 'A'		Outer Sheath 'E'	
NPT Size	NPT Catalog #	Min	Max
3/4"	EBY2672	0.250	0.437
3/4"	EBY2682	0.375	0.500
3/4"	EBY26102	0.500	0.625

All dimensions in inches unless otherwise noted.

**EBY Features:**

- Standard material is aluminum
- Factory sealed conductors and seal on outer sheath of cable
- Three, 12-inch long, #12 type SF-2 (150°C rating) stranded pigtailed; two circuit wires and one identified grounding wire
- Three pressure connectors for 3-conductor cord, range #18 to #12 AWG
- Standard neoprene seal suitable for use in operating temperatures -25° to 40°C
- Available with NPT threads

**North American Standards -
General Purpose**

Gland Type:

Armoured and TECK armoured

Cable Type:

Metal-clad (interlocked or continuously welded corrugated armoured) and TECK

Certifications and Compliances:

- UL Listed – UL File E36379
- CSA Listed – CSA File LR291
- NEMA 4 and IP56
- Wet locations

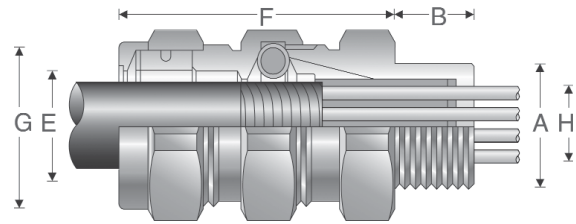

Features:

- Standard material is aluminum
- Stainless steel copper-plated spring provides grounding continuity of cable armour
- Watertight seal on outer sheath of cable
- Standard neoprene seal suitable for use in operating temperatures -25° to 60°C
- Cold Shrink™ Kit is available for extra protection in aggressive environments (see page 102)
- Available with NPT threads
- See page 102 for related accessories

ORDERING EXAMPLE:

TMC165 -BR	
Gland Type	Options

OPTIONS (add after gland type):

- BR Brass construction (i.e., TMC285-BR)
- NP Nickel-plate finish (i.e., TMC285-BR-NP)

SELECTION TABLE

Entry Thread Size 'A'		Thread Length 'B' NPT	Cable Acceptance				Gland Length 'F' (less entry)	Hexagon Dimensions	
NPT Size	NPT Catalog #		Armour Range 'H'		Outer Sheath 'E'			Across Flats	Across Corners 'G'
			Min	Max	Min	Max			
1/2"	TMC165	0.750	0.440	0.650	0.490	0.781	2.375	1.250	1.375
3/4"	TMC285	0.781	0.600	0.850	0.650	1.000	2.625	1.500	1.625
1"	TMC3112	0.938	0.800	1.120	0.850	1.313	2.625	1.875	2.000
1 1/4"	TMC4140	0.969	1.100	1.400	1.150	1.625	2.750	2.250	2.438
1 1/2"	TMC5161	0.969	1.330	1.610	1.380	1.781	2.750	2.500	2.75
2"	TMC6206	1.000	1.570	2.060	1.630	2.313	4.500	3.250	3.500
2 1/2"	TMC7247	1.438	1.930	2.470	1.990	2.719	4.750	3.750	4.000
3"	TMC8302	1.438	2.450	3.020	2.525	3.281	4.875	4.500	4.875
3 1/2"	TMC9352	1.625	2.950	3.520	3.025	3.781	5.375	5.000	5.375
4"	TMC10402	1.625	3.500	4.020	3.585	4.281	5.500	5.500	5.875

All dimensions in inches unless otherwise noted.

**North American Standards -
General Purpose**

4F

Gland Type:

Armoured

Cable Type:

TECK armoured

Certifications and Compliances:

- CSA Certified Class II, Div. 1 & 2, Groups E, F, G; Class III - CSA File LR13046
- Type 4 and IP56
- Wet locations

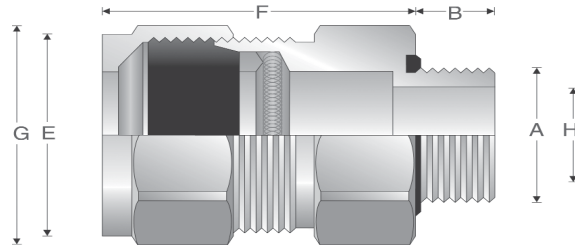

Features:

- Standard material is aluminum
- Stainless steel copper-plated spring provides grounding continuity of cable armour (TECK cable only)
- Watertight seal on outer sheath of cable
- Standard neoprene seal suitable for use in operating temperatures -25° to 60°C
- Cold Shrink™ Kit is available for extra protection in aggressive environments (see page 102)
- An integral o-ring seal on entry threads
- Available with NPT threads
- See page 102 for related accessories

SELECTION TABLE

Aluminum Catalog #	Steel Catalog #	Stainless Steel Catalog #	PVC Catalog #	Entry Thread Size 'A' NPT Size	Thread Length 'B' NPT	Cable Acceptance				Gland Length 'F' (less entry)	Hexagon Dimensions	
						Armour Range 'H'		Outer Sheath 'E'			Across Flats	Across Corners 'G'
						Min	Max	Min	Max			
TECK050 1	TECK050 1S	TECK050 1SS	TECK050 1PVC	1/2"	0.630	0.415	0.570	0.525	0.650	2.300	1.250	1.350
TECK050 2	TECK050 2S	TECK050 2SS	TECK050 2 PVC	1/2"	0.630	0.490	0.680	0.600	0.760	2.300	1.375	1.500
TECK050 3	TECK050 3S	TECK050 3SS	TECK0503PVC	1/2"	0.630	0.615	0.805	0.725	0.885	2.300	1.500	1.600
TECK050 4	TECK050 4S	TECK050 4SS	TECK050 4PVC	1/2"	0.630	0.715	0.905	0.825	0.985	2.300	1.500	1.600
TECK075 5	TECK075 5S	TECK075 5SS	TECK075 5PVC	3/4"	0.630	0.770	0.985	0.880	1.065	2.500	2.000	2.125
TECK075 6	TECK075 6S	TECK075 6SS	TECK075 6PVC	3/4"	0.630	0.915	1.125	1.025	1.205	2.500	2.000	2.125
TECK100 7	TECK100 7S	TECK100 7SS	TECK1007PVC	1"	0.750	1.077	1.295	1.187	1.375	2.625	2.250	2.400
TECK125 8	TECK125 8S	-	TECK125 8PVC	1 1/4"	0.800	1.240	1.545	1.350	1.625	3.500	3.000	3.125
TECK125 9	TECK125 9S	-	TECK125 9PVC	1 1/4"	0.800	1.390	1.545	1.500	1.625	3.400	3.000	3.125
TECK125 10	TECK125 10S	-	TECK125 10PVC	1 1/4"	0.800	1.490	1.795	1.600	1.875	3.500	3.000	3.125
TECK150 11	TECK150 11S	-	TECK150 11PVC	1 1/2"	0.800	1.590	1.885	1.700	1.965	3.800	3.750	3.600
TECK150 12	TECK150 12S	-	TECK150 12PVC	1 1/2"	0.800	1.790	2.107	1.900	2.187	3.900	3.500	3.750
TECK200 13	TECK200 13S	-	TECK200 13PVC	2"	0.825	1.790	2.107	1.900	2.187	4.000	3.750	4.000
TECK200 14	TECK200 14S	-	TECK200 14PVC	2"	0.825	1.990	2.280	2.100	2.375	4.000	3.750	4.000
TECK200 15	TECK200 15S	-	TECK200 15PVC	2"	0.875	2.190	2.485	2.300	2.565	4.000	4.125	4.400
TECK200 16	TECK200 16S	-	TECK200 16PVC	2"	0.875	2.390	2.656	2.500	2.750	4.000	4.125	4.400
TECK250 17	TECK250 17S	-	TECK250 17PVC	2 1/2"	1.300	2.240	2.560	2.380	2.640	5.000	4.500	4.750
TECK250 18	TECK250 18S	-	TECK250 18PVC	2 1/2"	1.300	2.440	2.750	2.580	2.840	5.000	4.500	4.750
TECK300 19	TECK300 19S	-	TECK300 19PVC	3"	1.400	2.640	2.970	2.790	3.060	5.000	4.600	4.900
TECK300 20	TECK300 20S	-	TECK300 20PVC	3"	1.400	2.870	3.190	3.000	3.270	5.000	4.900	5.250
TECK300 21	TECK300 21S	-	TECK300 21PVC	3"	1.400	3.042	3.390	3.210	3.480	5.000	5.000	5.250
TECK350 22	TECK350 22S	-	TECK350 22PVC	3 1/2"	1.400	3.270	3.590	3.420	3.690	5.000	5.600	5.900
TECK350 23	TECK350 23S	-	TECK350 23PVC	3 1/2"	1.400	3.440	3.770	3.610	3.870	5.000	5.500	5.900
TECK400 24	TECK400 24S	-	-	4"	1.400	3.600	3.930	3.810	4.030	5.000	6.125	6.500
TECK400 25	TECK400 25S	-	-	4"	1.400	3.755	4.065	3.965	4.185	5.000	6.125	6.500
TECK400 26	TECK400 26S	-	-	4"	1.400	3.910	4.220	4.120	4.340	5.000	6.125	6.500

All dimensions in inches unless otherwise noted.

North American Standards - General Purpose

Gland Type:

Non-armoured

Cable Type:

Non-armoured and tray cable

Certifications and Compliances:

- cULus Listed - UL File E23223
- Suitable for use in Class I, Div. 2 hazardous locations when installed in accordance with NEC501.10(B)(2)

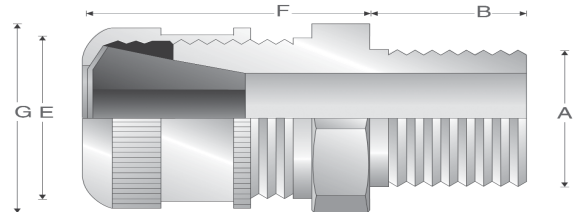

Features:

- Form A - D bodies and gland nuts – steel with zinc electroplate and chromate finish coat
- Form E - F bodies and gland nuts – Feraloy® iron alloy with electrogalvanized and aluminum acrylic paint
- Weatherproof seal on outer sheath of cable
- Standard neoprene seal suitable for use in operating temperatures -25° to 40°C
- Available with NPT threads
- Available in all aluminum construction
- See page 102 for related accessories

ORDERING EXAMPLE:

CGB192	-SG
Gland Type	Options

OPTIONS (add after gland type):

- SG Sealing Gasket* – only applies to certain sizes (e.g., CGB192-SG)
- SA Aluminum Construction† – only applies to certain sizes (e.g., CGB114-SA)

SELECTION TABLE

Entry Thread Size 'A'		Form	Thread Length 'B' NPT	Cable Acceptance		Gland Length 'F' (less entry)	External Diameter 'G'	Hexagon Dimensions	
NPT Size	NPT Catalog #			Outer Sheath 'E'				Across Flats	Across Corners 'G'
				Min	Max				
3/8"	CGB3814	A	0.438	0.125	0.250	1.063	–	0.750	0.875
3/8"	CGB3816	A	0.438	0.250	0.375	1.063	–	0.750	0.875
3/8"	CGB3817	A	0.438	0.375	0.437	1.063	–	0.750	0.875
3/8"	CGB3892	B	0.438	0.125	0.250	1.313	–	1.000	1.188
3/8"	CGB3893	B	0.438	0.250	0.375	1.313	–	1.000	1.188
3/8"	CGB3894	B	0.438	0.375	0.500	1.313	–	1.000	1.188
1/2"	CGB114†	A	0.625†	0.125	0.250	1.000	–	0.875	1.188
1/2"	CGB116†	A	0.625†	0.250	0.375	1.000	–	0.875	1.188
1/2"	CGB117†	A	0.625†	0.375	0.437	1.000	–	0.875	1.188
1/2"	CGB192*†	B	0.750*†	0.125	0.250	1.313	–	1.000	1.188
1/2"	CGB193*†	B	0.750*†	0.250	0.375	1.313	–	1.000	1.188
1/2"	CGB194*†	B	0.750*†	0.375	0.500	1.313	–	1.000	1.188
1/2"	CGB195*†	B	0.750*†	0.500	0.625	1.313	–	1.000	1.188
1/2"	CGB196*	C	0.625*	0.625	0.750	1.750	–	1.500	1.656
1/2"	CGB197*†	C	0.625*†	0.750	0.875	1.750	–	1.500	1.656
3/4"	CGB292†	B	0.625†	0.125	0.250	1.375	–	1.060	1.250
3/4"	CGB293†	B	0.625†	0.250	0.375	1.375	–	1.060	1.250
3/4"	CGB294†	B	0.625†	0.375	0.500	1.375	–	1.060	1.250
3/4"	CGB295†	B	0.625†	0.500	0.625	1.375	–	1.060	1.250
3/4"	CGB296*†	C	0.625*†	0.625	0.750	1.750	–	1.630	1.656
3/4"	CGB297*†	C	0.625*†	0.750	0.875	1.750	–	1.630	1.656
3/4"	CGB298*†	D	0.625*†	0.875	1.000	2.500	2.250	–	–
1"	CGB393†	B	0.688†	0.250	0.375	1.375	–	1.375	1.625
1"	CGB394†	B	0.688†	0.375	0.500	1.375	–	1.375	1.625
1"	CGB395*†	C	0.688*†	0.500	0.625	1.688	–	1.500	1.875
1"	CGB396*†	C	0.688*†	0.625	0.750	1.688	–	1.500	1.875
1"	CGB397*†	C	0.688*†	0.750	0.875	1.688	–	1.500	1.875
1"	CGB3239†	C	0.688†	0.875	1.000	1.688	–	–	1.875
1"	CGB398*†	D	0.625*†	0.875	1.000	2.375	2.375	–	–
1"	CGB399*†	D	0.625*†	1.000	1.188	2.375	2.375	–	–
1"	CGB3911*†	D	0.625*†	1.188	1.375	2.375	2.375	–	–

All dimensions in inches unless otherwise noted.

*With optional Sealing Gasket.

†With optional Aluminum Construction.

North American Standards - General Purpose

4F

Entry Thread Size 'A'		Form	Thread Length 'B' NPT	Cable Acceptance		Gland Length 'F' (less entry)	External Diameter 'G'	Hexagon Dimensions	
NPT Size	NPT Catalog #			Outer Sheath 'E'				Across Flats	Across Corners 'G'
				Min	Max				
1/4"	CGB498	D	0.688	0.875	1.000	2.313	2.250	-	-
1/4"	CGB499	D	0.688	1.000	1.188	2.313	2.250	-	-
1/4"	CGB4911	D	0.688	1.188	1.375	2.313	2.250	-	-
1/4"	CGB4913	E	0.688	1.375	1.625	2.625	3.000	-	-
1/4"	CGB4915	E	0.688	1.625	1.875	2.625	3.000	-	-
1/2"	CGB598	D	0.813	0.875	1.000	2.313	2.250	-	-
1/2"	CGB599	D	0.813	1.000	1.188	2.313	2.250	-	-
1/2"	CGB5911	D	0.813	1.188	1.375	2.313	2.250	-	-
1/2"	CGB5913	E	0.813	1.375	1.625	2.625	3.000	-	-
1/2"	CGB5915	E	0.813	1.625	1.875	2.625	3.000	-	-
2"	CGB6913	E	0.813	1.375	1.625	2.625	3.000	-	-
2"	CGB6915	E	0.813	1.625	1.875	2.625	3.000	-	-
2"	CGB6917	F	0.813	1.875	2.188	2.563	3.750	-	-
2"	CGB6920	F	0.813	2.188	2.500	2.563	3.750	-	-
2 1/2"	CGB7913	E	1.000	1.375	1.625	2.625	3.125	-	-
2 1/2"	CGB7915	E	1.000	1.625	1.875	2.625	3.125	-	-
2 1/2"	CGB7917	F	1.000	1.875	2.188	2.625	3.750	-	-
2 1/2"	CGB7920	F	1.000	2.188	2.500	2.625	3.750	-	-
3"	CGB8917	F	1.000	1.875	2.188	2.625	3.750	-	-
3"	CGB8920	F	1.000	2.188	2.500	2.625	3.750	-	-

**North American Standards -
General Purpose**

Gland Type:

Non-armoured

Cable Type:

Non-armoured and tray cable

Certifications and Compliances:

- cULus Listed - UL File E23223
- Suitable for use in Class I, Div. 2 hazardous locations when installed in accordance with NEC501.10(B)(2)

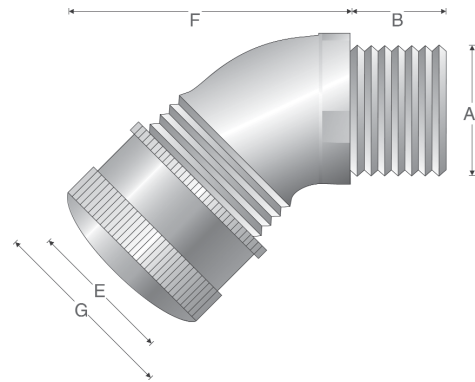

Features:

- 45° angle with male thread
- Standard body material is Feraloy® iron alloy
- Standard gland nut material is steel
- Weatherproof seal on outer sheath of cable
- Standard neoprene seal suitable for use in operating temperatures -25° to 40°C
- Available with NPT threads
- See page 102 for related accessories

SELECTION TABLE

Entry Thread Size 'A'		Thread Length 'B' NPT	Cable Acceptance Outer Sheath 'E'		Gland Length 'F' (less entry)	External Diameter 'G'
NPT Size	NPT Catalog #		Min	Max		
1/2"	CGD192	0.630	0.125	0.250	1.688	1.188
1/2"	CGD193	0.630	0.250	0.375	1.688	1.188
1/2"	CGD194	0.630	0.375	0.500	1.688	1.188
1/2"	CGD195	0.630	0.500	0.625	1.688	1.188
1/2"	CGD196	0.630	0.625	0.750	2.063	1.625
1/2"	CGD197	0.630	0.750	0.875	2.063	1.625
3/4"	CGD292	0.630	0.125	0.250	1.938	1.141
3/4"	CGD293	0.630	0.250	0.375	1.938	1.141
3/4"	CGD294	0.630	0.375	0.500	1.938	1.125
3/4"	CGD295	0.630	0.500	0.625	1.938	1.125
3/4"	CGD296	0.630	0.625	0.750	2.000	1.625
3/4"	CGD297	0.630	0.750	0.875	2.000	1.625

All dimensions in inches unless otherwise noted.

**North American Standards -
General Purpose**

4F

Gland Type:

Non-armoured

Cable Type:

Non-armoured and tray cable

Certifications and Compliances:

- cULus Listed - UL File E23223
- Suitable for use in Class I, Div. 2 hazardous locations when installed in accordance with NEC501.10(B)(2)

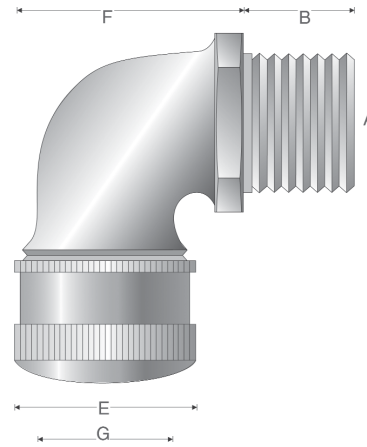

Features:

- 90° angle with male thread
- Standard body material is Feraloy® iron alloy
- Standard gland nut material is steel
- Weatherproof seal on outer sheath of cable
- Standard neoprene seal suitable for use in operating temperatures -25° to 40°C
- Available with NPT threads
- See page 102 for related accessories

SELECTION TABLE

Entry Thread Size 'A'		Thread Length 'B' NPT	Cable Acceptance		Gland Length 'F' (less entry)	External Diameter 'G'
NPT Size	NPT Catalog #		Outer Sheath 'E'			
			Min	Max		
1/2"	CGE192	0.710	0.1250	0.2500	1.438	1.188
1/2"	CGE193	0.710	0.2500	0.3750	1.438	1.188
1/2"	CGE194	0.710	0.3750	0.5000	1.438	1.188
1/2"	CGE195	0.710	0.5000	0.6250	1.438	1.188
1/2"	CGE196	0.710	0.6250	0.7500	2.000	1.625
1/2"	CGE197	0.710	0.7500	0.8750	2.000	1.625
3/4"	CGE292	0.710	0.1250	0.2500	1.406	1.188
3/4"	CGE293	0.710	0.2500	0.3750	1.406	1.188
3/4"	CGE294	0.710	0.3750	0.5000	1.406	1.188
3/4"	CGE295	0.710	0.5000	0.6250	1.406	1.188
3/4"	CGE296	0.710	0.6250	0.7500	1.875	1.625
3/4"	CGE297	0.710	0.7500	0.8750	1.875	1.625
1"	CGE395	0.710	0.5000	0.6250	2.063	1.625
1"	CGE396	0.710	0.6250	0.7500	2.094	1.625
1"	CGE397	0.710	0.7500	0.8750	2.094	1.625
1"	CGE3239	0.710	0.8750	1.0000	2.094	2.250
1"	CGE398	0.710	0.8750	1.0000	2.656	2.250
1"	CGE399	0.710	1.0000	1.1880	2.656	1.625
1"	CGE3911	0.710	1.1880	1.3750	2.656	2.250

All dimensions in inches unless otherwise noted.

**North American Standards -
General Purpose**

Gland Type:

Portable cord connector

Cable Type:

Non-armoured and tray cable

Certifications and Compliances:

- cULus Listed - UL File E23223
- Suitable for use in Class I, Div. 2 hazardous locations when installed in accordance with NEC501.10(B)(2)

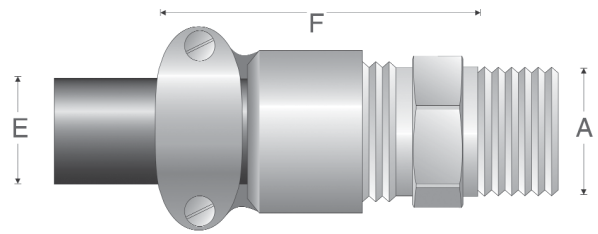

Features:

- Body – steel with zinc electroplate and chromate finish coat
- Gland nut – material is aluminum
- Standard neoprene seal suitable for use in operating temperatures -25° to 40°C
- Available with NPT threads
- See page 102 for related accessories

SELECTION TABLE

Entry Thread Size 'A'		Outer Sheath 'E'		
NPT Size	NPT Catalog #	Min		Max
1/2"	CGB1013	0.312		0.437
1/2"	CGB1014	0.375		0.500
1/2"	CGB1015	0.500		0.625
3/4"	CGB2013	0.312		0.437
3/4"	CGB2014	0.375		0.500
3/4"	CGB2015	0.500		0.625

All dimensions in inches unless otherwise noted.

4F

CGFP

North American Standards - General Purpose

4F

Gland Type:

Non-armoured

Cable Type:

Non-armoured and tray cable

Certifications and Compliances:

- Suitable for use in Class I, Div. 2 hazardous locations when installed in accordance with NEC501.10(B)(2)

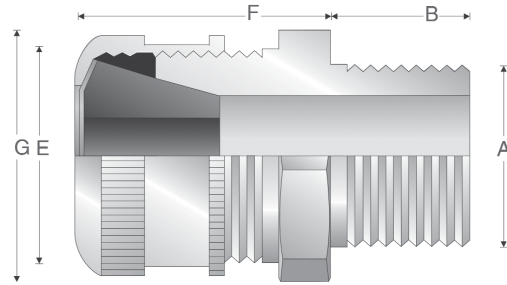

Features:

- Form B - C standard body and gland nut are turned steel
- Form D - G standard body and gland nut are Feraloy® iron alloy
- Weatherproof seal on outer sheath of cable
- Standard neoprene seal suitable for use in operating temperatures -25° to 40°C
- Available with NPT threads
- See page 102 for related accessories

SELECTION TABLE

Entry Thread Size 'A'		Form	Thread Length 'B' NPT	Cable Acceptance Outer Sheath 'E'		Gland Length 'F' (less entry)	External Diameter 'G'
NPT Size	NPT Catalog #			Min	Max		
1/2"	CGFP192	B	0.750	0.1250	0.2500	1.375	1.281
1/2"	CGFP193	B	0.750	0.2500	0.3750	1.375	1.281
1/2"	CGFP194	B	0.750	0.3750	0.5000	1.375	1.281
1/2"	CGFP195	B	0.750	0.5000	0.6250	1.375	1.281
3/4"	CGFP296	C	0.750	0.6250	0.7500	1.750	1.781
3/4"	CGFP297	C	0.750	0.7500	0.8750	1.750	1.781
3/4"	CGFP2239	C	0.750	0.8750	1.0000	1.750	1.781
1"	CGFP396	C	0.938	0.6250	0.7500	1.750	1.781
1"	CGFP397	C	0.938	0.7500	0.8750	1.750	1.781
1"	CGFP3239	C	0.938	0.8750	1.0000	1.750	1.781
1 1/4"	CGFP499	D	0.938	1.0000	1.1880	2.375	2.250
1 1/4"	CGFP4911	D	0.938	1.1880	1.3750	2.375	2.250
1 1/2"	CGFP599	D	0.938	1.0000	1.1880	2.375	2.250
1 1/2"	CGFP5911	D	0.938	1.1880	1.3750	2.375	2.250
2"	CGFP6913	E	1.000	1.3750	1.6250	3.250	3.250
2"	CGFP6915	E	1.000	1.6250	1.8750	3.250	3.250
2 1/2"	CGFP7917	F	1.438	1.8750	2.1880	3.250	3.875
2 1/2"	CGFP7920	F	1.438	2.1880	2.5000	3.250	3.875
3"	CGFP8917	F	1.500	1.8750	2.1880	3.250	3.875
3"	CGFP8920	F	1.500	2.1880	2.5000	3.250	3.875
3 1/2"	CGFP923	G	1.563	2.5000	3.0000	4.250	5.500
3 1/2"	CGFP927	G	1.563	3.0000	3.5000	4.250	5.500
4"	CGFP1023	G	1.625	2.5000	3.0000	4.250	5.500
4"	CGFP1027	G	1.625	3.0000	3.5000	4.250	5.500

All dimensions in inches unless otherwise noted.

**North American Standards -
General Purpose**

Gland Type:

Non-armoured

Cable Type:

Non-armoured and tray cable

Certifications and Compliances:

- cULus Listed - UL File E23223

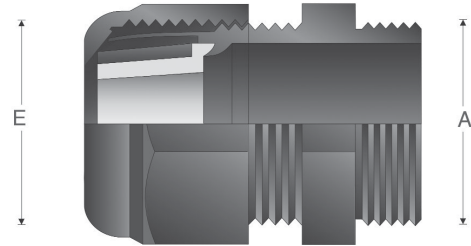

SELECTION TABLE

Entry Thread Size 'A'		Outer Sheath 'E'	
NPT Size	NPT Catalog #	Min	Max
3/8"	NCG38 35	0.10	0.35
1/2"	NCG50 50	0.20	0.50
3/4"	NCG75 75	0.35	0.75
1"	NCG100 100	0.55	1.00

All dimensions in inches unless otherwise noted.



NCG Features:

- Standard material is polyamide 6
- Weatherproof seal on outer sheath of cable
- Standard neoprene seal suitable for use in operating temperatures -25° to 40°C
- Available with NPT threads

**POLYAMIDE LOCK NUT
SELECTION TABLE**

Size	Catalog #
3/8"	10N
1/2"	11N
3/4"	12N
1"	13N

Gland Type:

Non-armoured

Cable Type:

Non-armoured and tray cable

Certifications and Compliances:

- cULus Listed - UL File E23223
- NEMA 3, 4X

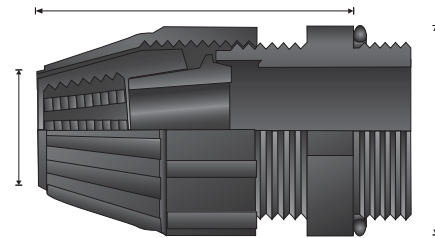

SELECTION TABLE

NPT Size	NPT Catalog #	Cable Acceptance Range 'E'		Gland Length (Less Entry) 'F'	External Diameter 'G'
		Min	Max		
1/2"	NCGB1231	0.25	0.42	2.25	1.33
1/2"	NCGB1232	0.40	0.57	2.25	1.33
3/4"	NCGB2233	0.54	0.68	2.52	1.58
3/4"	NCGB2234	0.64	0.78	2.52	1.58
1"	NCGB3235	0.76	0.91	3.19	2.02
1"	NCGB3236	0.89	1.03	3.19	2.02

All dimensions in inches unless otherwise noted.

NCGB Features:

- Standard material is thermoplastic polyester
- Tightens by hand to create a watertight seal
- Gasket on entry threads included
- Compact design allows close grouping of connectors
- Available with NPT threads

4F Accessories – A Series

4F

A Series – Lock Nut – Standard material is nickel-plated brass

METRIC SELECTION TABLE

Entry Thread	A	B	Catalog #
M16	3	19	CAP221694
M20	4	24	CAP222094
M25	4	30	CAP222594
M32	4.5	36	CAP223294
M40	4.5	46	CAP224094
M50	4.7	65	CAP225094
M63	6.4	80	CAP226394
M75	6.4	95	CAP227594
M90	8	110	CAP229094
M110	12	130	CAP221104

NPT SELECTION TABLE

Entry Thread	A	B	Catalog #
1/2"	3.75	25.4	CAP280124
3/4"	4	33	CAP280134
1"	4.75	40	CAP280144
1 1/4"	5.25	50	CAP280154
1 1/2"	5.75	55.9	CAP280164
2"	6.25	70	CAP280174
2 1/2"	9	90	CAP280184
3"	10	105	CAP280194

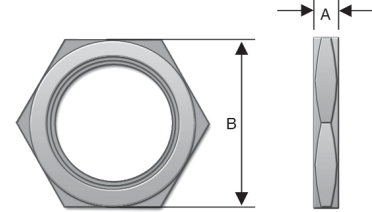

* For stainless steel replace last digit with "9".

A Series – Sealing Washer – Standard material is neoprene

METRIC SELECTION TABLE

Metric Size	Metric Catalog #	Metric Diam. 'D'	Metric Thickness 'E'
10	CAP221049	15.0	1.2
12	CAP221249	18.0	1.2
16	CAP221649	22.0	1.2
20	CAP222049	24.0	1.2
25	CAP222549	30.0	1.5
32	CAP223249	42.0	1.5
40	CAP224049	52.0	1.5
50	CAP225049	63.0	1.5
63	CAP226349	77.0	2.0
-	-	-	-
-	-	-	-

NPT SELECTION TABLE

NPT Size	NPT Catalog #	NPT Diam. 'D'	NPT Thickness 'E'
1/4"	CAP229014	20.0	1.5
3/8"	CAP229038	22.0	1.5
1/2"	CAP229012	27.0	1.5
3/4"	CAP229034	33.0	1.5
1"	CAP229010	41.0	1.5
1 1/4"	CAP229114	52.0	1.5
1 1/2"	CAP229112	57.0	1.5
2"	CAP229020	71.0	2.0
2 1/2"	CAP229212	85.0	2.0
3"	CAP229300	104.0	2.0
3 1/2"	CAP229312	120.0	2.0

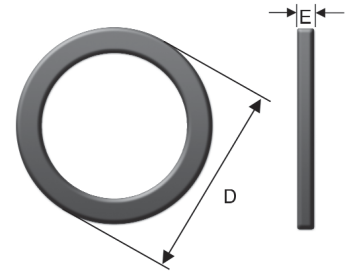

A Series – Earth Tag – Standard material is nickel-plated brass

METRIC SELECTION TABLE

Entry Thread	A	B	C	D	Catalog #
M16	48.75	30	6.75	24.5	CAP567034
M20	53.8	33	7	28.6	CAP567054
M25	61.5	36	10.5	34	CAP567074
M32	73	41	12.2	42	CAP567094
M40	86.5	44.5	13.5	54	CAP567124
M50	111.5	58	13.5	67	CAP567154
M63	125.5	67	13.5	77	CAP567184
M75	137.5	73	13.5	89	CAP567194

NPT SELECTION TABLE

Entry Thread	A	B	C	D	Catalog #
1/2"	61.5	36	10.5	34	CAP567064
3/4"	73	41	12.2	42	CAP567084
1"	73	41	12.2	42	CAP567104
1 1/4"	86.5	44.5	13.5	54	CAP567134
1 1/2"	111.5	58	13.5	67	CAP567154
2"	125.5	67	13.5	77	CAP567174
2 1/2"	137.5	73	13.5	89	CAP567194

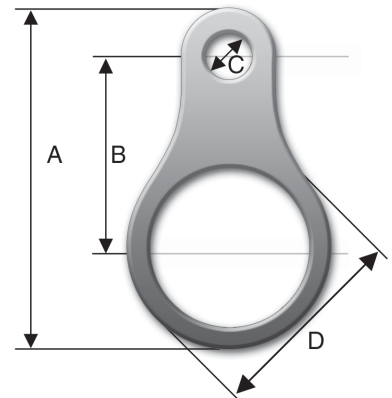

All dimensions in millimeters unless otherwise noted.

A Series – Serrated Lock Washer

– Standard material is stainless steel

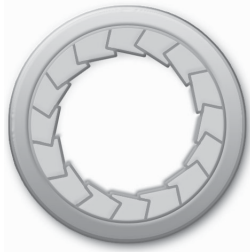

SELECTION TABLE

Metric Size	External Diameter	Catalog #
16	25.5	CAP280069
20	32.5	CAP280029
25	39.5	CAP280259
32	49.5	CAP280329
40	64.5	CAP280409
50	80.5	CAP280509
63	100	CAP280639
75	112	CAP280759
90	123	CAP280099

A-Series – Shroud

– Standard material is PVC



SELECTION TABLE

Gland Size	Catalog #
4	CAP506040
5	CAP506050
6	CAP506060
7	CAP506070
8	CAP506080
9	CAP506090
10	CAP506100
11	CAP506110
12	CAP506120
13	CAP506130
14	CAP506140
15	CAP506150
16	CAP506160

A Series – Clamping Module

– Standard materials are nickel-plated brass body with stainless steel screws and washers

SELECTION TABLE

Cable Range	Gland Size	Across Flats	Width	Thickness	Catalog #
4-8.5	4	15	18	5	CAP810434
6-11	5	19	22	5	CAP810534
8.5-16	6	24	27.5	6	CAP810634
12-21	7	30	33.5	8	CAP810734
16-27.5	8	41	45	8	CAP810834
21-34	9	48	52	9.5	CAP810934
27-41	10	55	59	9.5	CAP811034
33-48	11	64	69	12	CAP811134
40-56	12	72	78	12	CAP811234
47-65	13	85	92	16	CAP811334
54-74	14	95	103	16	CAP811434
63-83	15	110	118	18	CAP811534
72-93	16	120	128	18	CAP811634

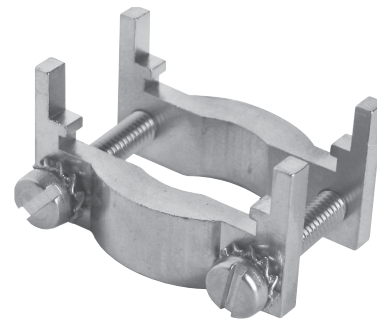

A Series – Earthing Washer – Standard material is brass

METRIC SELECTION TABLE

Gland Size	Lead Sheath Sealing Range		Cable Diameter	Catalog #
	Min	Max		
5	4	7.5	10	CAP560530
6	6	11	13.9	CAP560630
7	9	15	18.3	CAP560730
8	12	20	23.8	CAP560830
9	16	26.5	31	CAP560930
10	21	32.5	38.3	CAP561030
11	28	39.5	45.3	CAP561130
12	33	46.5	52.8	CAP561230
13	40	54.5	60.8	CAP561330
14	46.5	61	71	CAP561430
15	54	72.5	80.5	CAP561530
16	63	81.5	89.5	CAP561630

All dimensions in millimeters unless otherwise noted.



4F Accessories – A Series

4F

A Series – Adaptors and Reducers – Standard material is nickel-plated brass
ATEX Exe Exd with LCIE 98 ATEX 00010

ORDERING EXAMPLE: CAP745334

METRIC x METRIC SELECTION TABLE

Female →

Male	M12	M16	M20	M25	M32	M40	M50	M63	M75	M80	M90	M110
M12		745334										
M16	745834		740274									
M20	745844	740024		740544								
M25		740034	740294		740814							
M32			740304	740564		741084						
M40				740574	740834		741354					
M50					740844	741104		741624				
M63						741114	741374		741894			
M75							741384	741644		745394		
M90									745864			
M110												

METRIC x NPT SELECTION TABLE

Female →

Male	1/4"	3/8"	1/2"	3/4"	1"	1 1/4"	1 1/2"	2"	2 1/2"	3"	3 1/2"
M12	744104										
M16		744194	744694								
M20	744204	744214	744704	744964							
M25			744714	744974	745234						
M32			744724	744984	745244	745504					
M40				744994	745254	745514	745774				
M50					745264	745524	745784	746044			
M63							745794	746054	746314		
M75								746064	746324	746584	
M90										744304	
M110											

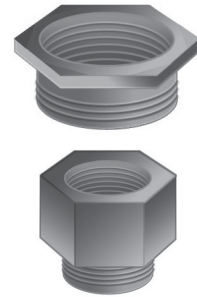

■ Size available – no part number
□ Size not available

NPT x METRIC SELECTION TABLE

Female →

Male	M12	M16	M20	M25	M32	M40	M50	M63	M75	M90	M100	M110
1/4"	740614	740624										
3/8"	740884	740894	740904									
1/2"	740914	740194	740454	740714								
3/4"		740204	740464	740724	740984							
1"			740474	740734	740994	741264	741524					
1 1/4"				740744	741004	741274	741534	741794				
1 1/2"						741104	741284	741544	741804	742064		
2"								741554	741814			
2 1/2"									741824			
3"												
3 1/2"												
4"												

NPT x NPT SELECTION TABLE

Female →

Male	1/4"	3/8"	1/2"	3/4"	1"	1 1/4"	1 1/2"	2"	2 1/2"	3"	3 1/2"	4"
1/4"												
3/8"	745574		744624									
1/2"		745594		745134								
3/4"			744884		745404							
1"			744894	745154		745674						
1 1/4"				745164	745424		745944					
1 1/2"					745434	745694		746214				
2"						745704	745964		746484			
2 1/2"								746234		746504		
3"								746244				
3 1/2"												
4"												

* For stainless steel replace last digit with "9".

A Series – Stopping Plug – Standard material is nickel-plated brass;
ATEX Exe Exd with LCIE 98 ATEX 00010

METRIC SELECTION TABLE

Metric Size	Metric Catalog #*	Across Flats 'A'	Hex Thickness 'B'	Thread Length 'E'
12	CAP190124	14	2.8	15
16	CAP190164	18	3.0	15
20	CAP190204	23	3.0	15
25	CAP190254	28	3.5	15
32	CAP190324	36	4.0	15
40	CAP190404	44	4.0	15
50	CAP190504	54	5.0	16
63	CAP190634	67	5.5	17
75	CAP190754	80	6.0	18
80	CAP190804	85	7.0	20
90	CAP199904	95	8.0	22
100	CAP191004	110	10.0	22

* For stainless steel replace last digit with "9".

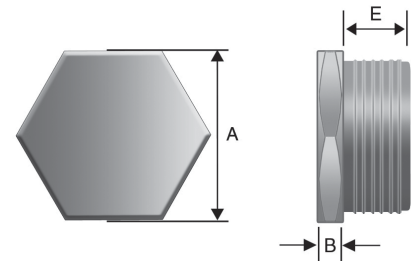

NPT SELECTION TABLE

NPT Size	NPT Catalog #*	Across Flats 'A'	Hex Thickness 'B'	Thread Length 'E'
1/4"	CAP190194	14	2.8	12
3/8"	CAP109294	18	2.8	12
1/2"	CAP190394	22	3.0	16
3/4"	CAP190494	28	3.0	16
1"	CAP190594	36	3.5	20
1 1/4"	CAP190694	44	4.0	20
1 1/2"	CAP190794	50	5.0	20
2"	CAP190894	64	5.5	20
2 1/2"	CAP190994	75	6.0	28
3"	CAP191094	90	6.0	30
3 1/2"	CAP191194	110	10.0	32

All dimensions in millimeters unless otherwise noted.

*For stainless steel replace last digit with "9".

A Series – Nonmetallic Stopping Plug – Standard material is polyamide 6; ATEX certified Ex e II with LCIE 97ATEX6007X

Washer and locknut are required for non-threaded holes (not included) see page 96

POLYAMIDE SELECTION TABLE

Metric Size	Metric Catalog #*	Across Flats 'A'	Hex Thickness 'B'	Thread Length 'E'
12	CAP191127	15	4	15
16	CAP191167	19	4	15
20	CAP191207	23	4	15
25	CAP191257	28	5	15
32	CAP191327	36	5.5	15
40	CAP191407	44	5.5	15
50	CAP191507	54	6	16
63	CAP191637	67	6.5	17

*For stainless steel replace last digit with "9".

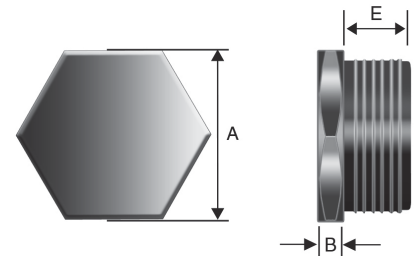

4F Accessories – B Series

4F

B Series – Lock Nut – Standard material is brass

METRIC SELECTION TABLE

Metric Entry Thread	Catalog #
M16	BLN/M16
M20	BLN/M20
M25	BLN/M25
M32	BLN/M32
M40	BLN/M40
M50	BLN/M50
M63	BLN/M63
M75	BLN/M75
M80	BLN/M80
M85	BLN/M85
M90	BLN/M90
M100	BLN/M100

NPT SELECTION TABLE

NPT Entry Thread	Catalog #
1/2"	BLN/050NPT
3/4"	BLN/075NPT
1"	BLN/100NPT
1 1/4"	BLN/125NPT
1 1/2"	BLN/150NPT
2"	BLN/200NPT
2 1/2"	BLN/250NPT
3"	BLN/300NPT
3 1/2"	BLN/350NPT
4"	BLN/400NPT



B Series – Sealing Washer – Standard material is nylon

METRIC SELECTION TABLE

Metric Entry Thread	Catalog #
M16	RNSW/M16
M20	RNSW/M20
M25	RNSW/M25
M32	RNSW/M32
M40	RNSW/M40
M50	RNSW/M50
M63	RNSW/M63
M75	RNSW/M75
M80	RNSW/M80
M85	RNSW/M85
M90	RNSW/M90
M100	RNSW/M100

NPT SELECTION TABLE

NPT Entry Thread	Catalog #
1/2"	RNSW/050NPT
3/4"	RNSW/075NPT
1"	RNSW/100NPT
1 1/4"	RNSW/125NPT
1 1/2"	RNSW/150NPT
2"	RNSW/200NPT
2 1/2"	RNSW/250NPT
3"	RNSW/300NPT
3 1/2"	RNSW/350NPT
4"	RNSW/400NPT



B Series – Earth Tag – Standard material is brass

METRIC SELECTION TABLE

Metric Entry Thread	Catalog #
M16	BET/M16
M20	BET/M20
M25	BET/M25
M32	BET/M32
M40	BET/M40
M50	BET/M50
M63	BET/M63
M75	BET/M75
M80	BET/M80
M85	BET/M85
M90	BET/M90
M100	BET/M100

NPT SELECTION TABLE

NPT Entry Thread	Catalog #
1/2"	BET/050NPT
3/4"	BET/075NPT
1"	BET/100NPT
1 1/4"	BET/125NPT
1 1/2"	BET/150NPT
2"	BET/200NPT
2 1/2"	BET/250NPT
3"	BET/300NPT
3 1/2"	BET/350NPT
4"	BET/400NPT



B Series – Shroud

PVC SELECTION TABLE

Size (Gland Size)	Catalog #
L24 (16, 20s)	PVC-L24
L30 (20)	PVC-L30
L38 (25)	PVC-L38
L46 (32)	PVC-L46
L55 (40)	PVC-L55
L65 (50, 50s)	PVC-L65
L80 (63, 63s)	PVC-L80
L90 (75, 75s)	PVC-L90
L104 (80,85)	PVC-L104
L114 (90, 100)	PVC-L114

PCP SELECTION TABLE

Size	Catalog #
L24 (16, 20s)	PCP-L24
L30 (20)	PCP-L30
L38 (25)	PCP-L38
L46 (32)	PCP-L46
L55 (40)	PCP-L55
L65 (50, 50s)	PCP-L65
L80 (63, 63s)	PCP-L80
L90 (75, 75s)	PCP-L90
L104 (80, 85)	PCP-L104



All dimensions in millimeters unless otherwise noted.

D Series – Lock Nut – Standard material is polyamide

SELECTION TABLE

Metric Entry Diameter	Width	Thickness	Catalog #
M12 x 1.5	17.00	5.00	GHG 960 1941 R0031
M16 x 1.5	22.00	5.00	GHG 960 1941 R0032
M20 x 1.5	26.00	6.00	GHG 960 1941 R0033
M25 x 1.5	32.00	6.00	GHG 960 1941 R0034
M32 x 1.5	41.00	7.00	GHG 960 1941 R0035
M40 x 1.5	50.00	7.00	GHG 960 1941 R0036
M50 x 1.5	60.00	8.00	GHG 960 1941 R0037
M63 x 1.5	75.00	8.00	GHG 960 1941 R0038



D Series – Reducing Ring – Standard material is polyamide

SELECTION TABLE

Thread 1	Thread 2	Length 1	Length 2	Length 3	Across Flats	Catalog #
20 x 1.5	M16 x 1.5	12.00	8.00	8.00	24.00	GHG 960 1946 R0071
25 x 1.5	M20 x 1.5	14.00	8.00	8.00	29.00	GHG 960 1946 R0072
32 x 1.5	M20 x 1.5	16.00	10.00	6.00	36.00	GHG 960 1946 R0056
32 x 1.5	M25 x 1.5	16.00	10.00	10.00	36.00	GHG 960 1946 R0074
40 x 1.5	M25 x 1.5	16.00	10.00	8.00	46.00	GHG 960 1946 R0059
40 x 1.5	M32 x 1.5	16.00	10.00	10.00	46.00	GHG 960 1946 R0077
50 x 1.5	M32 x 1.5	18.00	12.00	10.00	55.00	GHG 960 1946 R0062
50 x 1.5	M40 x 1.5	18.00	12.00	10.00	68.00	GHG 960 1946 R0080
63 x 1.5	M40 x 1.5	18.00	12.00	10.00	68.00	GHG 960 1946 R0065
63 x 1.5	M50 x 1.5	18.00	12.00	12.00	68.00	GHG 960 1946 R0083

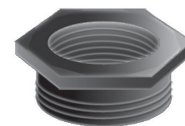

D Series – Screw Plug – Standard material is polyamide

SELECTION TABLE

Thread 1	Diameter	Length 1	Length 2	Catalog #
16 x 1.5	21.50	4.00	12.00	GHG 960 1952 R0111
20 x 1.5	25.50	4.00	13.00	GHG 960 1952 R0112
25 x 1.5	30.50	4.00	13.00	GHG 960 1952 R0113
32 x 1.5	37.50	5.50	15.00	GHG 960 1952 R0114
40 x 1.5	45.50	5.50	15.00	GHG 960 1952 R0115
50 x 1.5	55.50	5.50	16.00	GHG 960 1952 R0116
63 x 1.5	85.00	6.50	16.00	GHG 960 1952 R0117



D Series – Blanking Plug – For sealing unused cable glands;
Standard material is polyamide

SELECTION TABLE

Thread 1	Diameter	Length 1	Catalog #
12	6.00	30.30	GHG 960 1944 R0101
16	7.00	33.00	GHG 960 1944 R0102
20	8.50	34.50	GHG 960 1944 R0103
25	11.00	36.00	GHG 960 1944 R0104
32	14.00	39.50	GHG 960 1944 R0105
40	20.00	42.00	GHG 960 1944 R0106
50	26.00	44.00	GHG 960 1944 R0107
63	34.00	45.00	GHG 960 1944 R0108



All dimensions in millimeters unless otherwise noted.

4F Accessories – E Series

4F

E Series – Chico® LiquidSeal

SELECTION TABLE

Std. Carton Qty.	Size (ml.)	Catalog #
10	10 ml.	LSC 10
10	20 ml.	LSC 20
5	50 ml.	LSC 50



E Series – TSC Epoxy Sealing Compound

SELECTION TABLE

Std. Carton Qty.	Tube Size	Catalog #
10	0.5 oz.	TSC05
10	1.0 oz.	TSC1
5	4.0 oz.	TSC4



E Series – Wire Mesh Grip

SELECTION TABLE

Cord Range	Diameter	Gland Nut	Wire Mesh Grip Catalog #
.375 to .500		NUT94	RPE417-115
.500 to .625		NUT94	RPE417-116
.500 to .625		NUT95	RPE417-129
.625 to .750		NUT95	RPE417-117
.750 to .875		NUT95	RPE421-119
.875 to 1.000		NUT98	16676N
.875 to 1.000		NUT98	16676N
.875 to 1.000		NUT95	RPE421-120
.875 to 1.000		NUT98	16676N
1.000 to 1.188		NUT98	RPE421-121
1.188 to 1.375		NUT98	RPE433-122
1.375 to 1.625		NUT913	RPE433-123
1.625 to 1.875		NUT913	17317N



E Series – Cold Shrink™ Kit

SELECTION TABLE

Entry Thread	Catalog #
1/2"	TMC-K1
3/4"	TMC-K2
1"	TMC-K3
1 1/4"	TMC-K4
1 1/2"	TMC-K5
2"	TMC-K6
2 1/2"	TMC-K7
3"	TMC-K8
3 1/2"	TMC-K9
4"	TMC-K10

All dimensions in inches unless otherwise noted.

Cold Shrink™ Corrosion Protection Kits are specially designed for Eaton's Crouse-Hinds TMC, TMCX, and TECK fittings to provide protection against corrosive elements like salt spray and moisture. The TMC-K kit is made of a Cold Shrink material that is quick and easy to install on the gland. The Cold Shrink material is made of EPDM rubber that contains no chlorides or sulfurs. The protection kit installs easily over the gland without the use of a heat source to shrink the material tightly over the seal. The Cold Shrink material can be removed easily from the gland by simply cutting it off. See ordering information for complete offering of TMC-K Cold Shrink kits for corrosion protection. Cold Shrink is a registered trademark of the 3M Company.



Breather Drain – SIRA 99 ATEX 3050 U
 I M2 II, 2GD, EExe I & II (Stainless steel & brass only)
 II 2GD, EExe II (Nylon only)
 Enclosure type 4X IP66

SELECTION TABLE

Entry Thread	Material	Catalog #
M20	Brass	DPE1004S3
M20	Stainless Steel	DPE3004S3
M20	Nylon	DPE4004S3
M25	Brass	DPE1005S3
M25	Stainless Steel	DPE3005S3
M25	Nylon	DPE4005S3
1/2"	Brass	DPE1029S3
1/2"	Stainless Steel	DPE3029S3
3/4"	Brass	DPE1030S3
3/4"	Stainless Steel	DPE3030S3

Drainage Plug – Standard material is polyamide; PTB01 ATEX 1128X Ex 1126 Exe II

SELECTION TABLE

Thread 1	Diameter	Length 1	Length 2	Catalog #
M25 x 1.5	30.00	19.00	4.50	GHG 960 1927 R0105

Breathing and Drainage Plug – Standard material is glass-filled polyamide;
 SIRA 99 ATEX 3050 U Ex 1126 Exe II

SELECTION TABLE

Thread 1	Catalog #
M25 x 1.5	GHG 960 1954 R0002

All dimensions in millimeters unless otherwise noted.

Please refer to section 6F for additional breather and drain options.

4F LCC Series Cable Tray Conduit Clamps

4F

Applications:

LCC cable tray conduit clamps are used for installation on cable tray side rails with inside flanges (requiring inside tray mounting) and outside flanges; LCCF clamps are for use exclusively on inside flanges.

LCC/LCCF cable tray conduit clamps:

- Provide a means of clamping metal conduit (rigid steel or aluminum, IMC and EMT) to cable tray to provide for the exit of power and/or control cables from tray
- Provide a means to firmly bond exit conduit to cable tray for best grounding continuity
- Provide strong mechanical support for exit conduits and cables
- Can be used indoors or outdoors, wherever cable tray systems are installed
- Facilitate the safe exit of cables from tray – insure protection of cables from damage

Features:

- Quick and easy installation – low installed cost. Merely tighten clamp nut and/or set screw(s)
- Swivel hook clears conduit. No disassembly required for installation
- No drilling or welding necessary for installation
- Provides superior ground continuity between conduit and cable tray
- Clamps conduit at any angle with relation to tray – facilitates wire pulling, minimizes conduit bending
- Malleable iron body provides great strength
- Knurled body has no-slip surface for conduit and tray – positive grip assured
- Compact design has low profile – minimum tray space required for assembly
- Design accommodates all popular types of cable tray
- Accommodates wide range of conduit sizes – 1/2" through 4"

LCCF features:

- Outside mounting facilitates inside rail installation
- Adjustable hook assures positive grip on inside rail
- Accommodates 3/4" through 1 3/4" wide flange

Certifications and Compliances:

- UL Standard: 467 (Grounding and Bonding Equipment)

Standard Materials:

- Body – cast iron
- Hook – steel
- Set screws and clamping nut – steel
- Hook cap – vinyl

Standard Finishes:

- Cast iron – electrogalvanized and aluminum acrylic paint
- Steel – zinc electroplate
- Vinyl – natural

Conduit Size Ranges:

- 1/2" to 4"

LCC

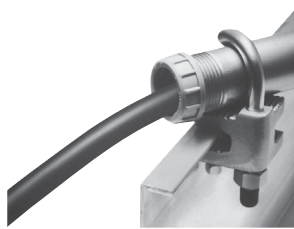

For use with outside rail tray

LCCF

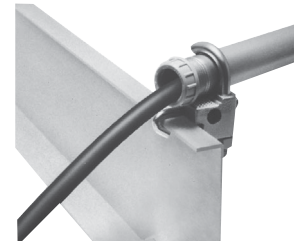

For use with inside rail tray

Ordering Information

Conduit Size	Cat. #	Cat. #
1/2	LCC1	LCCF1
3/4	LCC2	LCCF2
1	LCC3	LCCF3
1 1/4	LCC4	LCCF4
1 1/2	LCC5	LCCF5
2	LCC6	LCCF6
2 1/2	LCC7	LCCF7
3	LCC8	LCCF8
3 1/2	LCC9	LCCF9
4	LCC010	LCCF010

Dimensions In Inches:

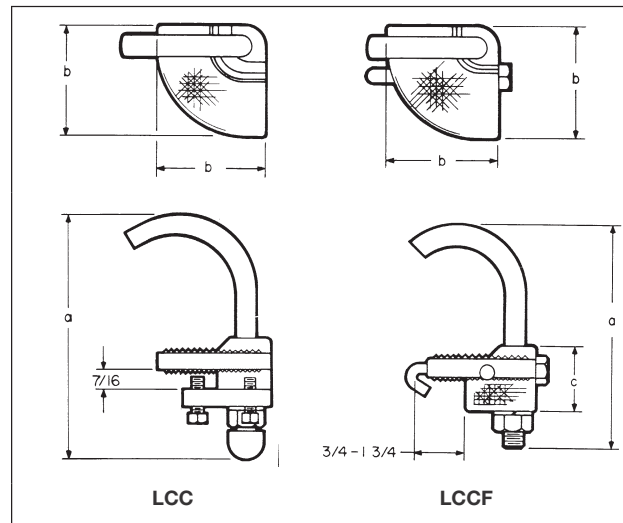

Conduit Size	LCC		LCCF		
	a	b	a	b	c
1/2	3 3/16	1 11/16	3 1/8	1 5/8	1 11/32
3/4	3 7/16	1 11/16	3 11/32	1 5/8	1 11/32
1	3 9/16	1 11/16	3 19/32	1 5/8	1 11/32
1 1/4	4	1 11/16	3 15/16	1 5/8	1 11/32
1 1/2	4 13/16	2 11/16	4 3/4	2 3/4	1 11/16
2	5 5/16	2 11/16	5 1/4	2 3/4	1 11/16
2 1/2	5 13/16	2 11/16	5 3/4	2 3/4	1 11/16
3	6 13/16	3 3/4	6 3/4	3 11/16	2 3/16
3 1/2	7 5/16	3 3/4	7 1/4	3 11/16	2 3/16
4	7 13/16	3 3/4	7 3/4	3 11/16	2 3/16

Applications:

Cable tray grounding conductor clamps are designed for use in heavy industrial applications:

- To provide a means for securely attaching a grounding conductor to cable tray to maintain grounding continuity for the entire cable tray system
- To provide protection of equipment through a reliable method for carrying ground fault currents
- To meet UL and NEC Code requirements
- For installation indoors or outdoors, with most types of cable trays with inside or outside flanges

Ordering Information

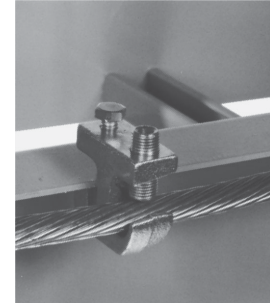
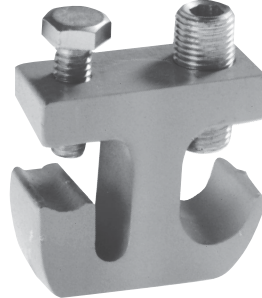

TGC Clamp installs on cable trays with inside or outside flanges

Ground Wire Size	Cat. #
#6 to 3/0	TGC40

Features:

- Meets requirements of NEC Code Article 318-7 for grounding and bonding
- Quick and easy installation – low installed cost. No drilling or special tools required.
- Accommodates solid (where suitable) or stranded aluminum or copper grounding conductors in sizes from #6 to 3/0
- Set screw bonds the clamp to the tray and another set screw securely attaches the grounding conductor to the clamp – outstanding pull-out and vibration resistance
- Design accommodates most popular types of cable tray
- Mechanical device – can be easily inspected
- Malleable iron body provides high strength

Dimensions In Inches:

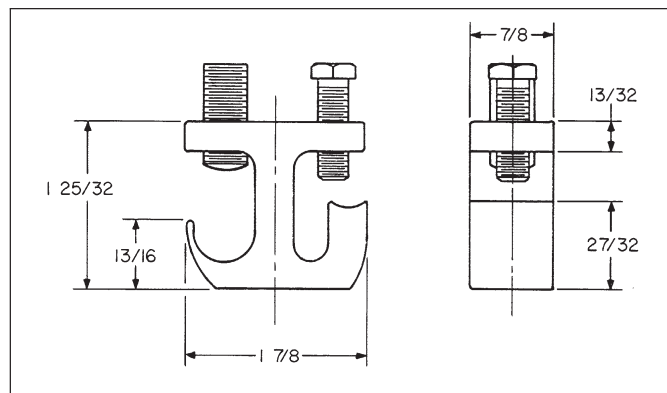

Certifications and Compliances:

- UL Standard: 467 (Grounding and Bonding Equipment)

Standard Materials:

- Body – malleable iron
- Set screws – steel

Standard Finishes:

- Malleable iron and steel – electrogalvanized

4F TW Series THRU-WALL BARRIER® Cable/Conduit Sealing Device

4F

Applications:

THRU-WALL BARRIER cable/conduit sealing device is used wherever there is a need to seal cables or conduits penetrating fire- or non-fire-rated walls, ceilings, floors, bulkheads or decks. For non-fire-rated walls, ceilings, floors, bulkheads or decks, THRU-WALL BARRIER also restricts water and dust and will help contain treated air. THRU-WALL BARRIER is designed:

- To provide a seal for cable/conduit penetrations through masonry, concrete or steel; to restrict the entrance of contaminants through cable/conduit penetrations into clean areas
- For use with most types of power, instrument and control cables as well as conduits
- To be used indoors or outdoors, in new construction or existing structures

Features:

System

- Few parts required to seal a wide range of diameters of cables or conduits
- Easy and fast installation, using factory assembled components
- High degree of flexibility with interchangeable sealing block assemblies and a selection of different sizes of frames

Mounting frame

- One-piece cast malleable iron or steel mounting frame can be cast into concrete during wall construction, grouted in masonry surfaces or welded into steel bulkheads at any time
- Retrofit frame allows for easy installation of frame where cables/conduit are already installed
- Available in sizes to accommodate a wide range of cable tray sizes and loadings, including single and multiple layers of cables for power or instrument applications
- Cast keyways in mounting frame align and position sealing block assemblies
- Frames can be installed in wall such that sealing block assemblies can be inserted in either horizontal or vertical position

Sealing block assembly

- Specially formulated elastomeric material between cast malleable iron pressure plates protects cable from mechanical damage; provides high pull-out resistance and positive cable separation; expands during fire to seal any voids left by burned cable insulation
- Interchangeable sealing block assemblies fit all THRU-WALL BARRIER mounting frames
- Cast stops on front pressure plate prevent sealing block assembly from slipping through mounting frame during installation
- Assemblies are offered for all cable/conduit outside diameters from .250" to 4.500" (6.4 mm to 114.3 mm); cables with diameters less than .250" can be accommodated – consult Eaton's Crouse-Hinds
- Sealing block openings will accommodate undersize and out-of-round cable
- Each sealing block assembly seals multiple cables/conduits; compact design permits close nesting of cables, saving space
- Reducers permit sealing block assemblies to accept cables with smaller O.D. than the specified range
- Plugs are used to fill unused openings in sealing block assemblies; blank sealing block assemblies fill unused spaces in mounting frames, providing for future expansion



Certifications and Compliances:

- ASTM Standard E-119
- NFPA 251
- UL Classification per UL Standard 1479
- USCG Acceptance – consult Eaton's Crouse-Hinds
- NAVSEA Approval – Electric Plant Installation Standard Methods No. S9300- AW-EDG-010/EPISM – TWFS/TWBS assemblies

Standard Materials:

- Mounting frame:
 - TWF, TWFR – cast malleable iron
 - TWFS – cast carbon steel, ASTM A27 Grade 60-30
- Pressure plate – cast malleable iron
- Sealing material – special elastomeric material
- Clamping hardware – steel

Standard Finishes:

- Malleable iron and hardware – electrogalvanized
- Steel – aluminized weldable paint
- Special elastomeric material – natural

Easy three step installation



1. Cast, grout or weld the one-piece mounting frame into masonry or steel surface.

2. Feed cables/conduit through the frame.

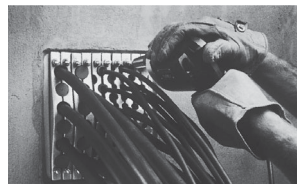

3. Position cables/conduit, insert factory assembled sealing blocks into keyways in mounting frame, and tighten nuts on clamping hardware to effect the seal.

TW Series THRU-WALL BARRIER® Cable/Conduit Sealing Device

4F

Sealing Block Assemblies & Mounting Frames Ordering Information

TWB Sealing Block Assemblies

TWB sealing block assemblies are offered for cable/conduit outside diameters (O.D.) from .250" to 4.500" (6.4 mm to 114.3 mm). Cables with diameters less than .250" can be accommodated – consult Eaton's Crouse-Hinds. Each assembly opening will accommodate a .250" (6.4 mm) O.D. range. When clamping hardware is tightened, the elastomeric material is uniformly compressed around all cable/conduits for a completely tight fit.

Sealing block assemblies are offered for use in marine applications. Each assembly has the required lubrication and sealing gaskets to meet U.S. Navy Hydrostatic Pressure Test Requirements. Assemblies for marine applications are available for cable/conduit outside diameters (O.D.) from .250" (6.4 mm) through 3.500" (88.9 mm). To order, add suffix S to TWB sealing block assembly Cat. No. Example: TWBS4036.



TWB2063

Depending on opening size range, a standard sealing block assembly will seal from one to eleven cables

Opening Size Range	In. mm	.250-.500 6.4-12.7	.500-.750 12.7-19.1	.750-1.000 19.1-25.4	1.000-1.250 25.4-31.8	1.250-1.500 31.8-38.1	1.500-1.750 38.1-44.5	1.750-2.000 44.5-50.8	2.000-2.250 50.8-57.2	2.250-2.500 57.2-63.5
No. Openings In Block		11 11 Added*	6 11 Added*	6	5	4	3	3	3	2
Sealing Block Assembly Cat. #		TWB2111 TWB1111	TWB2062 TWB2112	TWB2063	TWB3054	TWB3045	TWB30355	TWB4036	TWB40366	TWB5027
Frame Spaces Required		2 1	2 2	2	3	3	3	4	4	5
Plug Cat. #		TWP1		TWP3		TWP5		TWP6		TWP7
Reducer Cat. # §		—	TWR2	TWR3	TWR4	TWR5	TWR55	TWR6	TWR66	TWR7

TWF Mounting Frames

TWF(S) mounting frames may be installed either horizontally or vertically. TWFR retrofit frames are used wherever cables/conduits are already installed through a fire- or non-fire-rated wall, floor or ceiling. They are designed with a removable section to permit installation around cables/conduits. TWFR retrofit frames can be grouted into walls, floors, or ceilings, or welded into steel bulkheads or decks. TWFR retrofit frames will perform in the same manner as the one-piece TWF(S) frames.

TWFS steel mounting frames are welded directly into steel bulkheads, decks and prepared sleeves. For marine applications, keeper bars are provided to securely hold TWBS sealing block assemblies in position when installed.

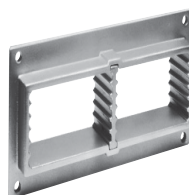

TWF12



TWF6

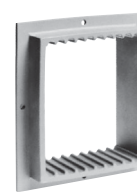

TWF10

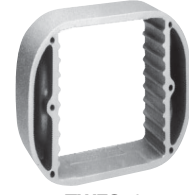

TWFS10

No. of Spaces Available	Frame Cat. #	Retrofit Frame Cat. #	Cast Steel Frame Cat. #
6	TWF6	TWFR6	
10	TWF10	TWFR10	TWFS10
12	TWF12†	TWFR12†	
20	TWF20	TWFR20	TWFS20
24	TWF24	TWFR24	
30	TWF30	TWFR30	TWFS30

†Includes removable partition.

†For 3.5" - 4" cable/conduit – use TWB7011010 assembly and reduce down using TWR reducers.

*Catalog # TWB1111 and TWB2112 are used between TWB2111 and TWB2062 in cases where the number of cables to be sealed in .250-.750 range exceeds the number of openings in standard assemblies. Use as many of these higher density assemblies as needed, sandwiched between halves of a standard assembly.

§TWR reducers match TWB sealing block assemblies shown in column above Cat. No. and reduce openings to accept cable size ranges shown in adjacent column to the left (in direction of arrow).

Crouse-Hinds

by **E•T•N**

4F

TW Series THRU-WALL BARRIER® Cable/Conduit Sealing Device

Plugs, Reducers, Closure Cover Kits, Anchors & Lubricant Ordering Information

4F

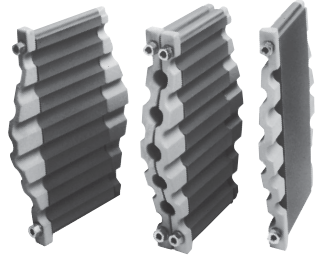

TWB2112 TWB2062

TWP Plugs



TWP plugs will close any unused openings in sealing block assemblies. See table for plug catalog numbers which match specific sealing block assemblies.

TWR Reducers



TWR reducers will reduce openings by .250" (6.4 mm) in sealing block assemblies. See table for reducer catalog numbers which match specific sealing block assemblies. More than one reducer can be used in a single opening.

It is possible to increase cable fill density with double-sided sealing block assemblies (TWB1111 and TWB2112) sandwiched between halves of a standard assembly.

2.500–2.750 63.5–69.9	2.750–3.000 69.9–76.2	3.000–3.250 76.2–82.6	3.250–3.500 82.6–88.9	3.500–4.250† 101.6–108.0	4.250–4.500 108.0–114.3	Blank – No Openings	
2	2	2	2	1	1	None	None
TWB50277	TWB5028	TWB60288	TWB6029	TWB7011010	TWB70111	TWB1	TWB3
5	5	6	6	7	7	1	3
TWP7	TWP8		TWP9	TWP10	TWP11	—	
TWR77	TWR8	TWR88	TWR9 TWR99	TWR1010 TWR10	TWR11	—	

TWB Closure Cover Kits

TWB closure cover kits offer an optional method to close TWF frames installed for future expansion or those that are abandoned. Closure cover kits include two covers clamped to opposite sides of the frame with hardware provided. The insulating material provided is sandwiched between the two covers to maintain the fire rating of the assembly. See table below for closure kit catalog numbers.

No. of Spaces Available	Closure Cover Kit Cat. #*
6	TWB600‡
10	TWB1000
12	TWB600‡
20	TWB2000
24	TWB2400
30	TWB3000

*TWB closure cover kits are not designed to provide a watertight seal in marine/shipboard applications or washdown areas. One kit seals one unused frame opening of same size. Example: use one TWB2000 kit to seal one TWF20, or TWFR20 frame.

‡Use two TWB600 kits to seal one TWF12 or TWFR12 frame opening.

TWK Anchors

TWK anchor assemblies are used to attach mounting frames to wall, ceiling or floor when grouting in frames.

Mounting Type	Cat. #
Flush	TWK1
Recessed	TWK2

TW Series THRU-WALL BARRIER® Cable/Conduit Sealing Device

Ordering Example A

Product Information

Selecting and specifying THRU-WALL BARRIER components is a simple procedure. Primary components for the THRU-WALL BARRIER consist of TWF mounting frames in various sizes and TWB sealing block assemblies for cable/conduit outside diameters (O.D.) in 1/4-inch increments from .250" to 4.500" (6.4 mm to 114.3 mm). Cables with diameters less than .250" can be accommodated – consult Eaton's Crouse-Hinds.

Cable/conduit sizes can be mixed within a sealing block assembly by inserting TWR reducers to accommodate smaller diameters. The use of reducers can decrease the number of sealing block assemblies required. More than one reducer can be used in a single opening.

Another way to increase density is to use TWB1111 and TWB2112 sealing block assemblies wherever there is a large number of cables/conduits in sizes ranging from .250" to .750".

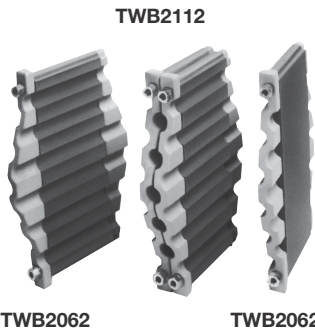

Shown here is a double-sided sealing block assembly (TWB2112) sandwiched between halves of a standard sealing block assembly (TWB2062). Additional double-sided sealing block assemblies may be used to accommodate larger quantities of cables or conduits.

Unused sealing block openings must be closed with TWP plugs. Blank sealing block assemblies TWB1 and TWB3 are used to fill each unused space in the mounting frame and permit future expansion of the system. Typical practice is to include space allowance of 20 to 50% for future expansion. TWB closure kits are used to seal entire frames and permit future system expansion.

Specifying & Ordering

The selection of components is based on the quantity and sizes of cables or conduits going through the penetrations. Once these are known, the sealing block assemblies and frames can be selected.

Step 1. Group cables/conduits by outside diameter (O.D.) and rank from the largest to the smallest.

Step 2. Keeping in mind that sealing block assemblies are available in one-quarter inch increments, group cables/conduits that fall within the same sealing block assembly O.D. size range.

Step 3. Starting with the largest cable/conduit O.D., select the sealing block assemblies required. All openings in each sealing block assembly must be filled.

Specify TWR reducers to accommodate smaller diameter cables where possible and TWP plugs to fill openings not used.

Step 4. Total the frame spaces required for the specified sealing block assemblies and select an appropriate mounting frame(s). Frames are available in 6-, 10-, 12-, 20-, 24- and 30-space sizes. Keep future expansion requirements in mind when specifying frame. Specify blank sealing block assemblies to fill unused mounting frame space and TWB closure cover kits to fill unused frames.

Step 5. Check specification/order to be sure it includes 1) frames, 2) sealing block assemblies, 3) plugs and 4) reducers.

Ordering Example A:

Cable tray size: 24"

Cables specified: 5 power cables – sizes ranging from 1.960" to 2.200" O.D.

Spare capacity required: 50%

Step 1. Group cables by O.D. and rank from largest to smallest.

	Cable Qty.	Cable O.D.
	4	2.200
	1	1.960
Total	5	

Step 2. Group cables that fall within the same sealing block assembly size.

	Cable Qty.	Sealing Block O.D. Range
	4	2.000–2.250
	1	1.750–2.000
Total	5	

Step 3. Starting with the largest cable O.D., select the quantity of sealing block assemblies required. Specify TWR reducers to accommodate smaller

diameter cables where possible and TWP plugs to fill openings not used. (See Example A diagram.)

Note: In the example, one TWR66 reducer is required to accommodate the cable with 1.960 O.D. and one TWP6 plug is required for the unused opening.

Step 4. Total the frame spaces required for sealing block assemblies and select appropriate size mounting frame. Factor in spare capacity required for future expansion.

Total frame spaces required	8
Specification requires 50% spare capacity	4
Total spaces	12

Selection: One TWF12 mounting frame with capacity of 12 spaces. Four TWB1 blank sealing block assemblies to fill unused frame space. (Choice of frame could vary based on future expansion needs and/or specific cable arrangement.)

Sealing Block Assy Cat. #	O.D. Range	Number of Openings	Cables to be Sealed	Number of Openings	Cables to be Sealed
TWB40366	2.000–2.250	3	3	—	4
TWB40366	2.000–2.250	3	2	1	4
Totals		66	5	1	8

Step 5. Bill of materials for specification/order should read:

- (1) TWF12
- (2) TWB40366
- (4) TWB1
- (1) TWR66
- (1) TWP6

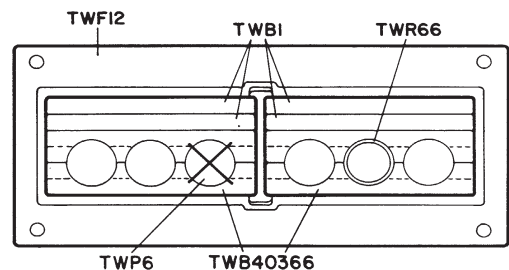

Example A diagram

4F TW Series THRU-WALL BARRIER® Cable/Conduit Sealing Device

Ordering Example B Dimensions

4F

Ordering Example B:

Cable tray size: 24"

Cables specified: 6 power cables – sizes ranging from 2.140" to 2.180" O.D. 31 control cables – sizes ranging from .550" to .945" O.D.

Spare capacity required: 25%

Step 1. Group cables by O.D. and rank from largest to smallest.

Cable Qty.	Cable O.D.
4	2.180
2	2.140
1	.945
4	.890
7	.700
9	.637
10	.550
Total	37

Step 2. Group cables that fall within the same sealing block assembly size.

Cable Qty.	Sealing Block O.D. Range
6	2.000–2.250
5	.750–1.000
26	.500–.750
Total	37

Step 3. Starting with the largest cable O.D., select the quantity of sealing block assemblies required. Specify TWR reducers to accommodate smaller diameter cables where possible and TWP plugs to fill openings not used. (See Example B diagram.)

Sealing Block Assy Cat. #	O.D. Range	Number of Openings	Cables to be Sealed	Openings Not Used	Frame Spaces Required
TWB40366	2.000–2.250	3	3	—	4
TWB40366	2.000–2.250	3	3	—	4
TWB2063	.750–1.000	6	5	1	2
TWB2062	.500–.750	6	6	—	2
TWB2112	.500–.750	11	11	—	2
TWB2112	.500–.750	11	9	2	2
Totals		40	37	3	16

Note: In this example, two TWB2112 sealing block assemblies are sandwiched between two halves of a TWB2062. This dramatically increases cable density in minimum frame space. One TWP3 plug is required for unused opening in TWB2063 and two TWP1 plugs are required for unused openings in the TWB2112.

Step 4. Total the frame spaces required for sealing block assemblies and select appropriate size mounting frame(s). Factor in spare capacity required for future expansion.

Total frame spaces required	16
Specification requires 25% spare capacity	4
Total	20

Selection: Two TWF10 (or one TWF20) mounting frames with total capacity of 20 spaces. One TWB3 and one TWB1 blank sealing block assembly to fill unused frame space. (Choice of frame could vary based on future expansion needs and/or specific cable/conduit arrangement.)

Step 5. Bill of materials for specification/order should read:

- (2) TWF10 or (1) TWF20
- (2) TWB40366
- (1) TWB2063
- (1) TWB2062
- (2) TWB2112
- (1) TWP3
- (2) TWP1
- (1) TWB3
- (1) TWB1

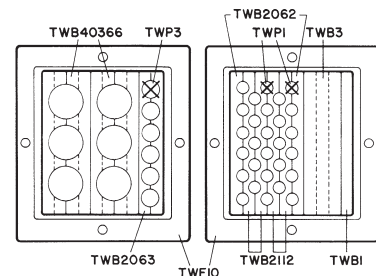

Example B diagram

*For TWFS mounting frame hole dimensions, contact Eaton's Crouse-Hinds ECM field representative or headquarters.

Dimensions In Inches:

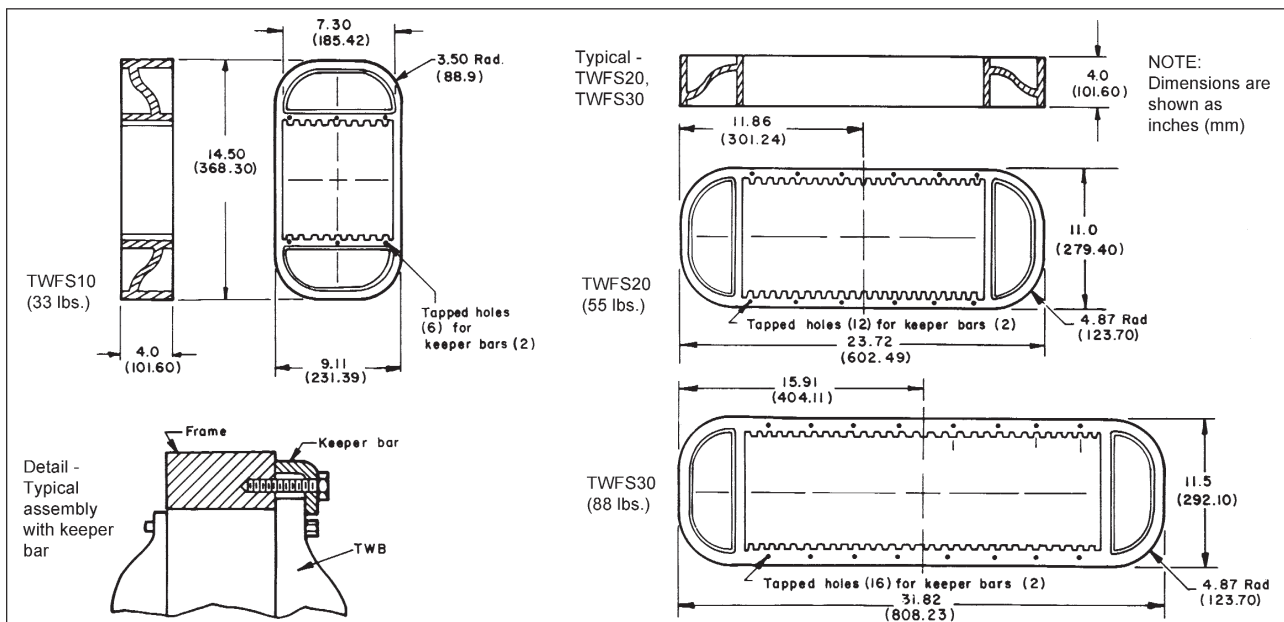

TW Series THRU-WALL BARRIER® Cable/Conduit Sealing Device

4F

Dimensions*

Dimensions In Inches:

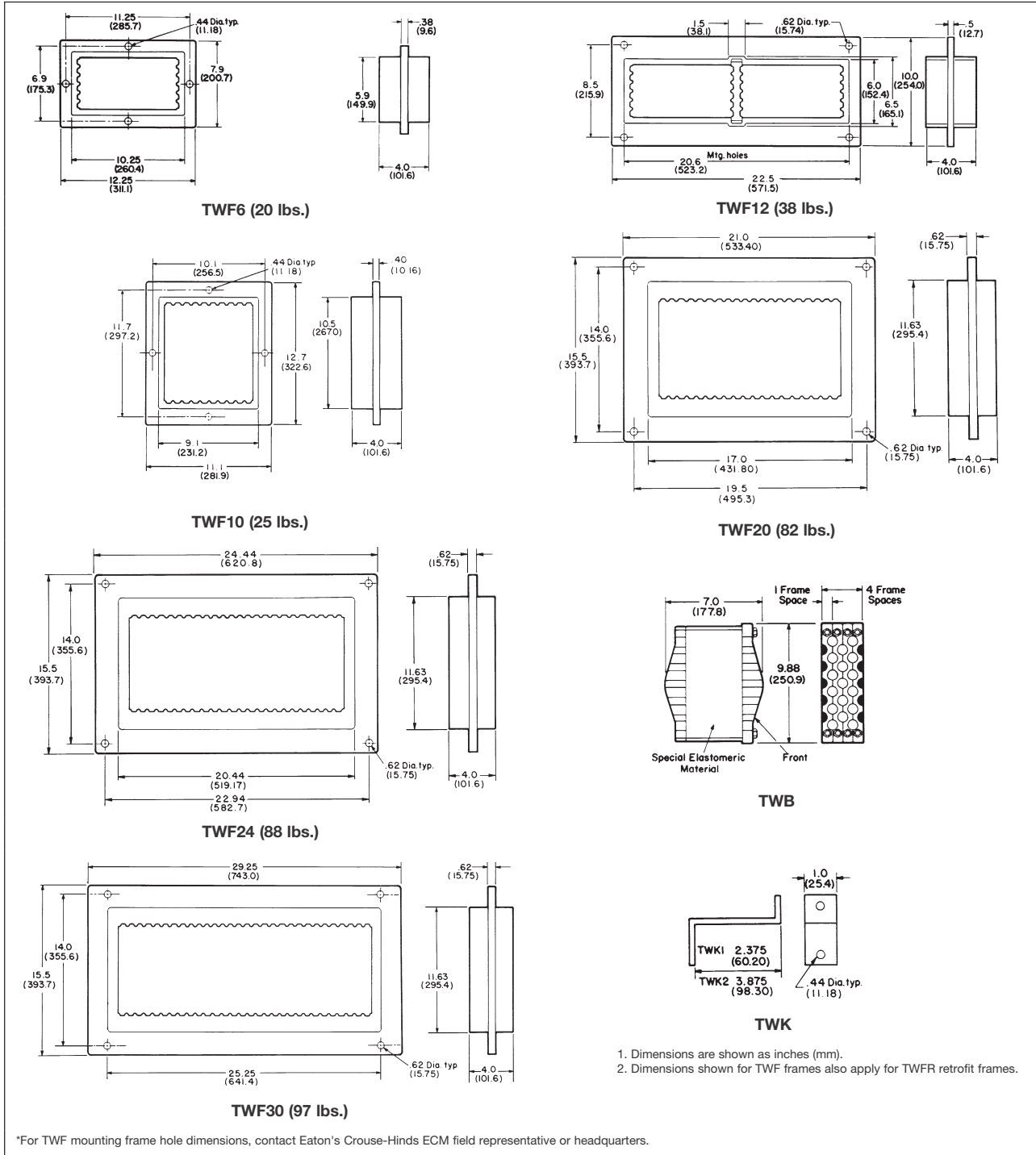

Environmental Seal for Conduit Passing Through Concrete Walls, Floors, or Ceilings

Link-Seal Devices

Applications:

- Eaton's Crouse-Hinds Link-Seal® is the quick, economical way to seal around conduit in concrete walls, floors and casings. Link-Seal is a modular mechanical seal used for any type of penetration.

Features and Benefits:

- Saves time and money – Link-Seal installs in up to 75% less time than competition products
- Positive Hydrostatic Sealing – properly installed, Link-Seal is rated at 20 psig (40 feet of head), which exceeds the performance requirements of most applications
- Environment Seals – Link-Seal environmental seal is designed for long life and use as a permanent seal. Seal elements are specially compounded to resist aging, ozone, sunlight, water and a wide range of chemicals
- Fire Seals – for fire protection in floor and wall penetrations Link-Seal is Factory Mutual approved
- Resistance to high and low temperatures – Link-Seal environmental seal is manufactured from special compounds that resist temperatures from -40°F to +250°F. Link-Seal Fire Seal is manufactured from a silicone material that resists temperatures from -67°F to +400°F
- Corrosion protection – where installation against galvanic corrosion (or electrolysis) is required, Link-Seal provides complete separation pipe and casing. Metal-to-metal contact is eliminated
- Compensates for misalignment – Link-Seal allows for some angular and off-center conduit conditions and still seals effectively
- Absorbs shock, sound and vibration – this inherent benefit of Link-Seal helps reduce conduit failure due to fatigue and threaded connections

Standard Materials:

- Rubber Seal Elements:
EPDM (Black) – Environmental Seals
Silicone (Grey) – Fire Seals
- Pressure Plates:
Glass Reinforced Nylon – Environmental Seals
Steel w/Zinc Dichromate Plate – Fire Seals
- Fasteners:
Carbon Steel, Zinc Dichromate Plate – Environmental Seals
316 Stainless Steel – Environmental with Option S316
Carbon Steel w/Zinc Dichromate – Fire Seals

Environmental Conduit Seal

Ordering Information:

It's easy. Locate the conduit size and type you are installing in the columns on the left. Then locate the seal and sleeve part numbers under the installation method you've selected. No sleeve is needed for cored or cast hole installation.

Cored or Cast Hole Method:

Note the appropriate hole diameter and select the seal part number. Example: For 3/4" EMT conduit through a cored hole – Core a 2" diameter hole and install the conduit using Link-Seal part number LSA200-C-04.

Sleeve Methods:

Select either the plastic or metal sleeve. Both types of sleeves are designed to be cast into concrete walls or floors. Sleeves are ordered separately. Remember to add the wall or floor thickness to the steel sleeve part number to insure the sleeve is provided in the proper length. Plastic sleeves are a standard 16 long and can be modified in the field.

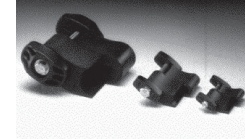
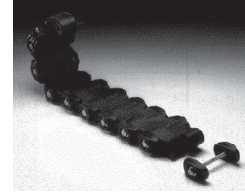

Materials:

The standard product for environmental conduit seals is made from EPDM supplied with steel bolts and nuts with a zinc dichromate finish. These seals are suitable for use in water, direct ground burial and atmospheric conditions. They provide electrical insulation where cathodic protection is required. EPDM rubber is resistant to most inorganic acids and alkalis, and some organic chemicals (acetone, alcohol, ketones).

Options:

To order the standard product with 316 stainless steel bolts and nuts, for corrosive environments, replace the "C" in the seal catalog number with "S316". For example, a 1/2" seal for rigid steel conduit for a cored hole is an LSA200-C-04; ordered with stainless steel bolts and nuts the catalog number becomes LSA200-S316-04.

Environmental Seal for Conduit passing through Concrete Walls, Floors or Ceilings

Ordering Information - Environmental Conduit Seal

Conduit Nominal Size	Conduit Type*	Conduit Actual O.D. (inches)	Cast/Cored Hole Dia. (inches)	Seal for Cast/Cored Hole Cat. #	Plastic Sleeve Cat. #	Seal for Plastic Sleeve Cat. #	Steel Sleeve Cat. #	Seal for Steel Sleeve Cat. #
1/2"	EMT	.706	2.000	LSA275 C 04	LS CS 2 16	LSA200 C 04	WS2 15 ①	LSA275 C 04
1/2"	IMC	.815	2.000	LSA200 C 04	LS CS 2 16	LSA200 C 04	WS2 21 ①	LSA200 C 04
1/2"	RSC	.840	2.000	LSA200 C 04	LS CS 2 16	LSA200 C 04	WS2 21 ①	LSA200 C 04
3/4"	EMT	.922	2.000	LSA200 C 04	LS CS 3 16	LSA315 C 04	WS2 15 ①	LSA200 C 04
3/4"	IMC	1.029	2.500	LSA275 C 06	LS CS 3 16	LSA315 C 04	WS2 15 ①	LSA200 C 04
3/4"	RSC	1.050	2.500	LSA275 C 06	LS CS 3 16	LSA315 C 04	WS2.5 20 ①	LSA275 C 06
1"	EMT	1.163	2.500	LSA315 C 04	LS CS 3 16	LSA300 C 04	WS2.5 20 ①	LSA275 C 06
1"	IMC	1.290	3.000	LSA300 C 04	LS CS 3 16	LSA300 C 04	WS2.5 10 ①	LSA275 C 06
1"	RSC	1.315	3.000	LSA300 C 04	LS CS 3 16	LSA300 C 04	WS2.5 20 ①	LSA200 C 05
1 1/4"	EMT	1.510	3.000	LSA300 C 04	LS CS 3.5 16	LSA315 C 05	WS3.5 22 ①	LSA315 C 05
1 1/4"	IMC	1.638	3.000	LSA275 C 07	LS CS 3.5 16	LSA300 C 05	WS3.5 22 ①	LSA315 C 05
1 1/4"	RSC	1.660	3.000	LSA275 C 07	LS CS 3 16	LSA200 C 06	WS3.5 22 ①	LSA315 C 05
1 1/2"	EMT	1.740	3.500	LSA315 C 05	LS CS 3.5 16	LSA300 C 05	WS3.5 32 ①	LSA315 C 05
1 1/2"	IMC	1.883	3.500	LSA300 C 05	LS CS 3.5 16	LSA275 C 08	WS3.5 22 ①	LSA300 C 05
1 1/2"	RSC	1.900	3.500	LSA300 C 05	LS CS 3.5 16	LSA275 C 08	WS3.5 22 ①	LSA300 C 05
2"	EMT	2.197	4.000	LSA315 C 06	LS CS 4 16	LSA315 C 06	WS4 23 ①	LSA315 C 06
2"	IMC	2.360	4.000	LSA300 C 06	LS CS 4 16	LSA300 C 06	WS4 23 ①	LSA300 C 06
2"	RSC	2.375	4.000	LSA300 C 06	LS CS 4 16	LSA300 C 06	WS4 23 ①	LSA300 C 06
2 1/2"	EMT/RSC	2.875	4.000	LSA200 C 09	LS CS 4 16	LSA200 C 09	WS4 23 ①	LSA200 C 09
2 1/2"	IMC	2.857	4.000	LSA200 C 09	LS CS 4 16	LSA200 C 09	WS4 23 ①	LSA200 C 09
3"	EMT/RSC	3.500	5.000	LSA300 C 08	LS CS 5 16	LSA300 C 08	WS5 25 ①	LSA300 C 08
3"	IMC	3.476	5.000	LSA300 C 08	LS CS 5 16	LSA300 C 08	WS5 25 ①	LSA300 C 08
3 1/2"	EMT/RSC	4.000	6.000	LSA325 C 05	LS CS 6 16	LSA325 C 05	WS6 28 ①	LSA325 C 05
3 1/2"	IMC	3.971	6.000	LSA325 C 05	LS CS 6 16	LSA325 C 05	WS6 28 ①	LSA325 C 05
4"	EMT/RSC	4.500	6.000	LSA300 C 10	LS CS 6 16	LSA300 C 10	WS6 28 ①	LSA300 C 10
4"	IMC	4.466	6.000	LSA300 C 10	LS CS 6 16	LSA300 C 10	WS6 28 ①	LSA300 C 10
5"	RSC	5.563	8.000	LSA425 C 06	LS CS 8 16	LSA425 C 06	WS8 32 ①	LSA425 C 06
6"	RSC	6.625	10.000	LSA475 C 10	LS CS 10 16	LSA475 C 10	WS8 18 ①	LSA300 C 15

*EMT – Electrical Metallic Tubing; IMC – Intermediate Metal Conduit; RSC – Rigid Steel Conduit

①Specify length of steel sleeve in inches. Example: S6-28-08 is 8" long. All plastic sleeves come in standard 16" lengths and can be field cut to desired length.

The last two digits of the seal part number indicate the number of links (and the number of bolts) per seal.

**Fire Seal for
Conduit passing through
Concrete Walls, Floors or Ceilings**

4F

**Fire Conduit Seal
Ordering Information:**

Locate the conduit size and type you are installing in the columns on the left. Then locate the seal and sleeve part number under the installation method you've selected. No sleeve is needed for cored or cast hole installation.

**Cored or Cast Hole
Method:**

Note the appropriate hole diameter and select the seal part number. Example: For 3/4" EMT conduit through a cored hole –Core a 2" diameter hole and install the conduit using Link-Seal Part number LSA200-T-04.

Sleeve Methods:

Select the appropriate metal sleeve for the size and type of conduit being installed. The sleeve should be ordered separately. Remember to add the wall or floor thickness to the steel sleeve part number to insure the sleeve is provided in the proper length.

Materials:

The standard product for fire conduit seals is made from grey silicone supplied with steel bolts and nuts with a zinc dichromate finish. These seals are Factory Mutual approved for use as a 1-hour fire stop and can handle temperature extremes of -67°F to +400°F.

Options:

To order the fire seal for a 3-hour rating, replace the "T" in the seal catalog number with a "FS". For example, a 1/2" seal for rigid steel conduit for a cored hole is an LSA200-T-04; ordered with option FS the catalog number becomes LSA200-FS-04. A 3-hour fire seal can also be made by using two Model T's back-to-back. The Model FS is basically two Model T's back-to-back. In Model FS, a tie rod tightens both seals simultaneously – for use when only one side of an opening is accessible.

Fire Conduit Seal - Ordering Information

Conduit Nominal Size	Conduit Type*	Conduit Actual O.D. (inches)	Cast/Cored Hole Dia. (inches)	Seal for Cast/Cored Hole Cat. #	Steel Sleeve Cat. #	Seal for Steel Sleeve Cat. #
1/2"	EMT	0.706	2.000	LSA275 T 04	WS2 15 ①	LSA275 T 04
1/2"	IMC	0.815	2.000	LSA200 T 04	WS2 21 ①	LSA200 T 04
1/2"	RSC	0.840	2.000	LSA200 T 04	WS2 21 ①	LSA200 T 04
3/4"	EMT	0.922	2.000	LSA200 T 04	WS2 15 ①	LSA200 T 04
3/4"	IMC	1.029	2.500	LSA275 T 06	WS2 15 ①	LSA200 T 04
3/4"	RSC	1.050	2.500	LSA275 T 06	WS2.5 20 ①	LSA275 T 06
1"	EMT	1.163	3.000	LSA315 T 04	WS2.5 20 ①	LSA275 T 06
1"	IMC	1.290	3.000	LSA300 T 04	WS2.5 10 ①	LSA275 T 06
1"	RSC	1.315	3.000	LSA300 T 04	WS2.5 20 ①	LSA200 T 05
1 1/4"	EMT	1.510	3.000	LSA300 T 04	WS3.5 22 ①	LSA315 T 05
1 1/4"	IMC	1.638	3.000	LSA275 T 07	WS3.5 22 ①	LSA315 T 05
1 1/4"	RSC	1.660	3.000	LSA275 T 07	WS3.5 22 ①	LSA300 T 05
1 1/2"	EMT	1.740	3.500	LSA315 T 05	WS3.5 32 ①	LSA300 T 05
1 1/2"	IMC	1.883	3.500	LSA300 T 05	WS3.5 22 ①	LSA300 T 05
1 1/2"	RSC	1.900	3.500	LSA300 T 05	WS3.5 22 ①	LSA275 T 08
2"	EMT	2.197	4.000	LSA315 T 06	WS4 23 ①	LSA315 T 06
2"	IMC	2.360	4.000	LSA300 T 06	WS4 23 ①	LSA300 T 06
2"	RSC	2.375	4.000	LSA300 T 06	WS4 23 ①	LSA300 T 06
2 1/2"	EMT/RSC	2.875	4.000	LSA200 T 09	WS4 23 ①	LSA200 T 09
2 1/2"	IMC	2.857	4.000	LSA200 T 09	WS4 23 ①	LSA200 T 09
3"	EMT/RSC	3.500	5.000	LSA300 T 08	WS5 25 ①	LSA300 T 08
3"	IMC	3.476	5.000	LSA300 T 08	WS5 25 ①	LSA300 T 08
3 1/2"	EMT/RSC	4.000	6.000	LSA325 T 05	WS6 28 ①	LSA325 T 05
3 1/2"	IMC	3.971	6.000	LSA325 T 05	WS6 28 ①	LSA325 T 05
4"	EMT/RSC	4.500	6.000	LSA300 T 10	WS6 28 ①	LSA300 T 10
4"	IMC	4.466	6.000	LSA300 T 10	WS6 28 ①	LSA300 T 10
5"	RSC	5.563	8.000	LSA425 T 06	WS8 32 ①	LSA425 T 06
6"	RSC	6.625	10.000	LSA475 T 10	WS8 18 ①	LSA300 T 15

①Specify length of steel sleeve in inches. Example: WS6-28-08 is 8" long.
*EMT – Electrical Metallic Tubing; IMC – Intermediate Metal Conduit; RSC – Rigid Steel Conduit
The last two digits of the seal part number indicate the number of links (and the number of bolts) per seal.

Dimensions

In Inches:

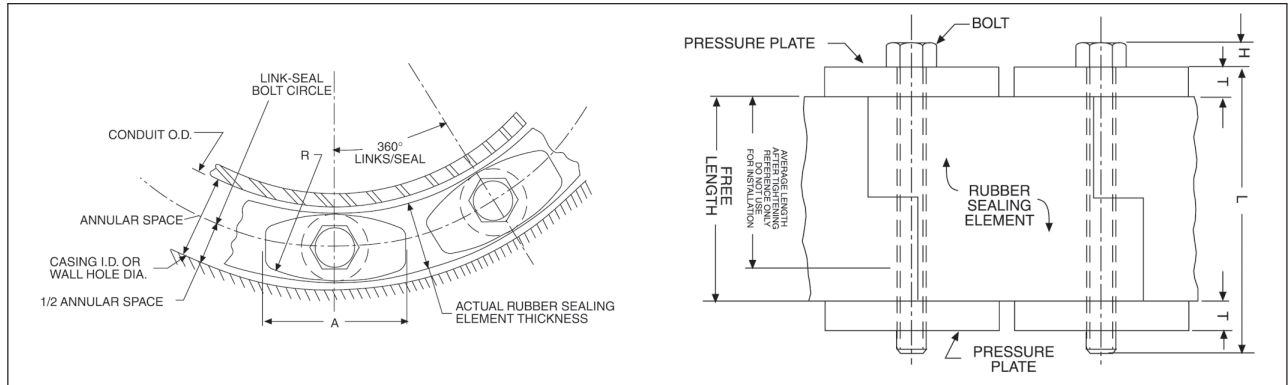

Technical Information

Link-Seal Cat. #	Rubber Sealing Element			Pressure Plate			Bolt			
	Actual Thickness (inches)	Free Length (inches)	Avg. Length After Tightening (inches)	A (inches)	R (inches)	T (inches)	Hex Across Flats	H (inches)	Thread Size (inches)	L
LSA200 C	.478	1¾	1⅝	1⅙	2¼	⅝	M5 slotted hex	.180	M5	2½
LSA275 C	.607	1¾	1⅝	7⁄8	1⅞	5⁄16	M5 slotted hex	.180	M5	2½
LSA300 C	.687	2½	2	1½	2½	7⁄16	½	7⁄32	5⁄16-5⁄18	3½
LSA315 C	.807	2½	2	1⅞	2½	7⁄16	½	7⁄32	5⁄16-5⁄18	3½
LSA325 C	.875	3	2⅞	3⅞	2	½	½	7⁄32	5⁄16-5⁄18	4
LSA425 C	1.062	3½	2¾	3½	3	¾	9⁄16	¼	3⁄8-3⁄16	5
LSA475 C	1.562	3½	2¾	3½	3½	½	9⁄16	¼	3⁄8-3⁄16	4½

4F

4F

Elbows, Couplings, Hubs, Grounding Devices, Plugs, Reducers, Service Entrance and Unions Hazardous and Non-hazardous

5F

Description	Page No.
Application/Selection	see page 118
Elbows	
EL Series	see page 121
FE / FT Series	see page 122
Flexible & Expansion Joint Couplings	
EC Series	see pages 127-128
XD Series	see page 129
XJG Series	see page 130
XJG-EMT Series	see page 131
XJGD Series	see page 132
Grounding Devices, Straps, Clamps	
GC Series	see page 134
Hubs	
HUB Series	see page 133
Pipe Plugs	
PLG Series	see page 124
NOR Series	see page 126
Reducers and Adapters	
AMN / ANM Series	see page 125
RE Series	see page 124
REA Series	see page 124
REC Series	see page 124
NOR Series	see page 126

Description	Page No.
Service Entrance Fittings	
Heads	
F Series	see page 135
Unions	
Non-Expansion	
UNA Series	see page 121
UNF Series	see page 120
UNL Series	see page 120
UNY Series	see page 120
Expansion	
UNF Series	see page 123
UNY Series	see page 123
UNFL Series	see page 123
UNYL Series	see page 123
Nipples	
NOR Series	see page 126
Conduit Liners	
LNR Series	see page 136



5F Elbows, Couplings, Hubs, Grounding Devices, Plugs, Reducers, Service Entrance and Unions

Application and Selection

5F

Applications:

Service entrance heads, elbows, unions, couplings, grounding receptacle and stud and grounding straps with clamps are the miscellaneous fittings needed to complete an electrical conduit system from the overhead service entrance to machinery, lighting fixtures and/or final electrical outlets. These fittings are installed in conduit systems within non-hazardous areas to:

- Plug
- Connect
- Reduce
- Terminate
- Change direction
- Ground

Use in Hazardous Areas:

- Most of the items shown above are also suitable for hazardous areas (see specific listings for compliance information).

Considerations for Selection:

Service Heads:

- Size required – determine from size and number of conductors in service and conduit or mast size.
- Type required – (threaded, slip fit, clamp) – determine from conduit used with service head.

Elbows, Unions, Reducers, Couplings and Grounding Receptacles/Connectors:

- Size required – determine from conduit size.
- Type required – determine from intended function in system (i.e. male and female thread for connecting conduit to outlet box etc.)
- Material and finish required – determine from environmental conditions (corrosive fumes, buried in concrete, etc.)

Options:

Description

Corro-free™ epoxy powder coat

Suffix

S752

Series	Page	Series	Page	Series	Page
--------	------	--------	------	--------	------

F	see page 135	UNL	see page 120	XD	see page 129
---	--------------	-----	--------------	----	--------------

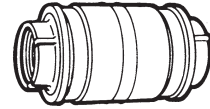
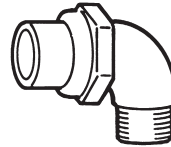
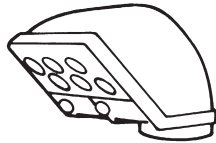

GCT	see page 134	UNF	see page 120	XJG	see page 130
-----	--------------	-----	--------------	-----	--------------

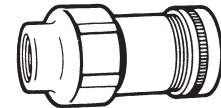
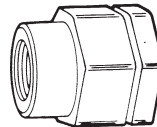
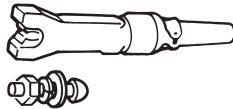

GC	see page 134	EL / FE	see pages 121-122	RE	see page 124
----	--------------	---------	-------------------	----	--------------

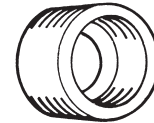
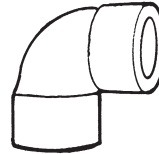

GCR	see page 134	LNR	see page 136	REA / AMN	see page 124
-----	--------------	-----	--------------	-----------	--------------

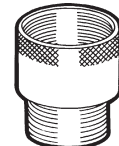
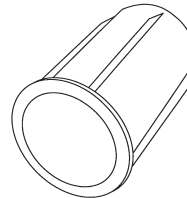
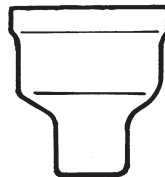

UNYL	see page 123	PLG	see page 124	REC	see page 124
------	--------------	-----	--------------	-----	--------------

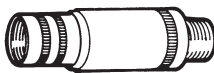

EC	see pages 127-128				
----	-------------------	--	--	--	--

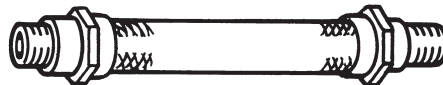

HUB	see page 133				
-----	--------------	--	--	--	--



XJGD	see page 132				
------	--------------	--	--	--	--



XJG-EMT	see page 131				
---------	--------------	--	--	--	--



Elbows, Couplings, Hubs, Grounding Devices, Plugs, Reducers, Service Entrance and Unions

5F

5F

Quick Selector Chart

Series	Description	Size Range	Conduit Type	Standard Materials
XD	Expansion/deflection coupling	1" to 6"	Threaded rigid	<i>Feraloy</i> ® iron alloy hubs, neoprene outer jacket, tinned copper grounding strap
F	Threaded service entrance head	½" to 4" conduit	Threaded rigid	Copper-free aluminum
F	Clamp type service entrance head	¾" to 2" conduit	Threadless rigid or EMT	Copper-free aluminum
GCT	Ground connector and stud	.312" to .406"	Used to provide "quick connect" static electricity grounding connections with portable cable	Bronze connector body; aluminum cable clamp; brass stud
GC100	Grounding strap	50' coil	Used for bonding and grounding	Flexible copper, tinned
GCR	Grounding receptacle	¾" threaded grounding rod	Used to provide static electricity grounding connection	Bronze body, cap and chain; brass grounding stud
GC102	Grounding clamp	Adjustable	Used as clamp for GC100	Brass
HUB	Conduit hub	½" to 4"	Threaded rigid	Steel or <i>Feraloy</i> iron alloy
UNL	Union, 90° angle; for connecting conduit to cast boxes	½" - ½" to ¾" - ¾"	Threaded rigid	<i>Feraloy</i> iron alloy
UNY	Union, male; for connecting conduit to cast boxes	½" to 6" / 20mm to 50mm	Threaded rigid	Steel or <i>Feraloy</i> iron alloy
UNF	Union, female; for connecting conduit to conduit	½" to 6" / 20mm to 50mm	Threaded rigid	Steel or <i>Feraloy</i> iron alloy
UNA Male	Union, 90° to 180° adjustable; for connecting conduit to boxes for conduit support	½" to 1"	Threaded rigid	<i>Feraloy</i> iron alloy
EL-45°	45° elbow, female	12" to 4"	Threaded rigid	<i>Feraloy</i> iron alloy
EL-90°	90° elbow, male; 90° elbow, female; 90° elbow, male and female	½" to 1¼" male; ½" to 2½" female; ½" to 1¼" male and female	Threaded rigid	<i>Feraloy</i> iron alloy
FE	90° elbow, metric	20mm to 25mm	Threaded rigid	Copper-free aluminium
RE	Reducer, threaded	½" - ⅝" to 6" - 5" / 20mm to 50mm	Threaded rigid	Steel or <i>Feraloy</i> iron alloy
REA / AMN	Adapter fitting	½" male to ¾" female; ¾" male to 1" female; 1" male to 1¼" female; 16mm to 63mm	Threaded rigid	Steel or Brass
REC	Reducer coupling	¾" - ½" to 5" - 4"	Threaded rigid	<i>Feraloy</i> iron alloy
PLG	Pipe plug, recessed head or square head	½" to 4" / 20mm to 63mm	Threaded rigid	Steel or <i>Feraloy</i> iron alloy or Brass
EC	Flexible coupling	½" to 4"	See catalog page 7F for details	
LNR	Conduit liner	½" to 4"	Threaded rigid & IMC	Polypropylene
XJG	Expansion fitting	½" to 6"	Threaded rigid or IMC	<i>Feraloy</i> iron alloy
XJG-EMT	Expansion fitting	½" to 4"	EMT	<i>Feraloy</i> iron alloy
XJGD	Expansion-deflection	1" to 4"	Threaded rigid	<i>Feraloy</i> iron alloy

5F Unions and Elbows

Cl. I, Div. 1 & 2, Groups A, B, C, D†
 Cl. II, Div. 1, Groups E, F, G
 Cl. II, Div. 2, Groups F, G
 Cl. III
 Explosionproof
 Dust-Ignitionproof

5F

Applications:

UNY and UNF unions are installed in threaded thickwall conduit systems:

- UNY – to connect conduit to a conduit fitting, junction box or device enclosure
- UNF – to connect conduit to conduit, or to provide a means for future modification of the conduit system

UNA unions are used in conduit and fitting installations when entrance angle is between 90° and 180°.

EL elbows are installed in conduit run or in box or fitting hub:

- To change direction in threaded rigid conduit run by 90°, or when terminating at a box or fitting

Features:

UNY, UNF and UNL unions have:

- Compact design which permits assembly with a minimum of clearance to other adjacent conduit and/or equipment
- Strong and durable construction

UNA unions:

- Have a single clamping nut on angle, making it both a union and a connector
- Permit conduit joints at angles between 90° and 180°

EL elbows have a smooth interior and are both strong and compact.

Certifications and Compliances:

<ul style="list-style-type: none"> • NEC/CEC: <p>Class I, Division 1 & 2, Groups A, B, C, D Class II, Division 1, Groups E, F, G Class II, Division 2, Groups F, G Class III EL ½", ¾", 1" UNF/UNY 105, -215, -205, -305 UNL 105, -125, -215, -205</p>
<p>Class I, Division 1 & 2, Groups B, C, D Class II, Division 1, Groups E, F, G Class II, Division 2, Groups F, G Class III UNF/UNY406, -506, -606, -706, -806, -905, -1005</p>
<p>Class I, Division 1 & 2, Groups C, D Class II, Division 1, Groups E, F, G Class II, Division 2, Groups F, G Class III EL, UNF, UNL, UNY - all sizes</p>
<p>Class I, Division 1 & 2, Group D Class II, Division 1, Groups E, F, G Class II, Division 2, Groups F, G Class III UNA</p>

- UL Standard: 1203
- CSA Standard: C22.2 No. 30

†See compliances for classification of each product.

Standard Materials:

- UNY, UNF unions – ½" to 1" – steel
- UNY, UNF unions – 1¼" to 6" – *Feraloy*® iron alloy
- UNL, UNA unions – *Feraloy* iron alloy
- EL elbows – *Feraloy* iron alloy or ductile iron

Standard Finishes:

- Steel – electrogalvanized with chromate treatment
- *Feraloy* iron alloy, malleable iron – electrogalvanized and aluminum acrylic paint

Options:

Description
 Copper-free aluminum
 Not available on UNA or 5" and 6" UNY/UNF

Suffix SA

UNY

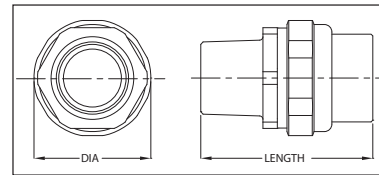

UNL



90° Angle

Size	Cat. #
½ to ½	UNL105
¾ female to ½ male	UNL125
½ female to ¾ male	UNL215
¾ to ¾	UNL205

Dimensions In Inches:

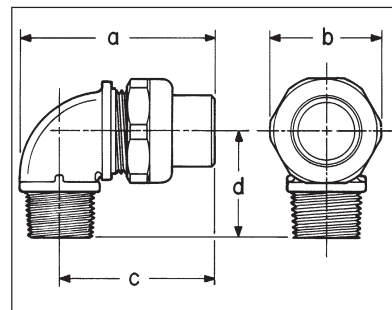

Size	Cat. #	Size	Cat. #
½	UNY105	½	UNF105
½ female to ¾ male	UNY215	¾ to ½	UNF215
¾	UNY205	¾	UNF205
1	UNY305	1	UNF305
1¼	UNY405	1¼	UNF405
1¼	UNY406	1¼	UNF406
1½	UNY505	1½	UNF505
1½	UNY506	1½	UNF506
2	UNY605	2	UNF605
2	UNY606	2	UNF606
2½	UNY705	2½	UNF705
2½	UNY706	2½	UNF706
3	UNY805	3	UNF805
3	UNY806	3	UNF806
3½	UNY905	3½	UNF905
4	UNY1005	4	UNF1005
5	UNY012	5	UNF012
6	UNY014	6	UNF014

UNY			UNF	
Size	Length	Max. Dia.	Length	Max. Dia.
½	2 ⁵ / ₁₆	1½	1 ¹³ / ₁₆	1½
¾ - ½	2 ¹¹ / ₁₆	1 ¹³ / ₁₆	1¾	1 ¹³ / ₁₆
¾	2 ¹¹ / ₁₆	1 ¹³ / ₁₆	1¾	1 ¹³ / ₁₆
1	3	1 ⁷ / ₈	2	1 ⁷ / ₈
1¼	3 ¹ / ₁₆	2¾	2¼	2¾
1½	4¼	3 ¹ / ₁₆	2 ⁵ / ₈	3 ¹ / ₁₆
2	4¼	3 ¹³ / ₁₆	2 ⁹ / ₁₆	3 ¹³ / ₁₆
2½	5 ⁷ / ₁₆	4 ⁵ / ₁₆	3 ³ / ₁₆	4 ⁵ / ₁₆
3	5¾	5 ¹ / ₁₆	3 ⁷ / ₁₆	5 ¹ / ₁₆
3½	6½	5 ¹¹ / ₁₆	4 ⁷ / ₈	5 ¹ / ₁₆
4	6 ⁵ / ₈	6 ³ / ₁₆	4 ⁷ / ₈	6 ¹ / ₁₆
5	6 ¹ / ₈	8 ³ / ₁₆	3 ¹³ / ₁₆	8 ³ / ₁₆
6	6 ¹ / ₈	9 ⁵ / ₁₆	3 ¹³ / ₁₆	9 ⁵ / ₁₆

UNL				
Dim.	105	125	215	205
a	2 ¹¹ / ₁₆	2 ¹¹ / ₁₆	2 ⁷ / ₈	2 ⁷ / ₈
b	1 ¹⁷ / ₃₂	1 ¹³ / ₁₆	1 ¹³ / ₁₆	1 ¹³ / ₁₆
c	2 ¹ / ₁₆	2 ¹ / ₁₆	2 ¹ / ₄	2 ¹ / ₄
d	1 ⁷ / ₁₆	1 ⁷ / ₁₆	1 ⁵ / ₈	1 ⁵ / ₈

Unions and Elbows

Cl. I, Div. 1 & 2, Groups C, D†
 Cl. II, Div. 1, Groups E, F, G
 Cl. II, Div. 2, Groups F, G
 Cl. III

Explosionproof
 Dust-Ignitionproof

5F



UNA

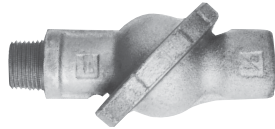

Male (with removable nipple)

Male
 Size

Cat. #

1/2	UNA16
3/4	UNA26
1	UNA36

EL

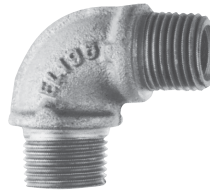

90° Male



45° Female

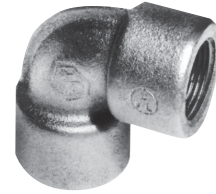

90° Female



90° Male and female

90° Male

Size	Cat. #
1/2	EL195
3/4	EL295
1	EL395

45° Female

Size	Cat. #
1/2	EL1
3/4	EL2
1	EL3
1 1/4	EL4
1 1/2	EL5
2	EL6
2 1/2	EL7
3	EL8
3 1/2	EL9
4	EL10

90° Female

Size	Cat. #
1/2	EL19*
3/4	EL29*
1	EL39*
1 1/4	EL49*
1 1/2	EL59*
2	EL69*
2 1/2	EL79

90° Male and Female

Size	Cat. #
1/2	EL196*
3/4	EL296*
1	EL396*
1 1/4	EL496

*Available in copper free aluminum – add suffix SA to catalog number.

Dimensions In Inches:

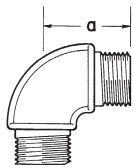

90° Male

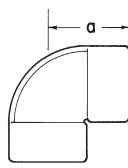

90° Female

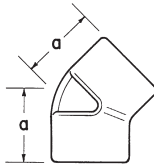

45° Female

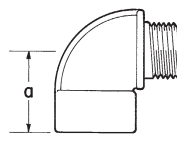

90° Male and female

EL

UNA

Male

Size	Length	Width
1/2	4 ⁹ / ₁₆	2 ⁵ / ₈
3/4	4 ¹³ / ₁₆	2 ⁷ / ₈
1	5 ¹ / ₁₆	3 ¹ / ₂

EL

Size	45° Female	90° Male	90° Female	90° Male & Female
	a	a	a	a
1/2	1 ³ / ₁₆	1 ⁷ / ₁₆	1 ¹⁷ / ₃₂	1 ¹⁷ / ₃₂
3/4	1 ³ / ₈	1 ⁵ / ₈	1 ³ / ₄	1 ⁵ / ₈
1	1 ²¹ / ₃₂	1 ⁷ / ₈	2	1 ⁷ / ₈
1 1/4	1 ³ / ₄		2 ¹ / ₄	2 ¹ / ₈
1 1/2	1 ¹⁵ / ₁₆		4	
2	2 ¹ / ₄		5	
2 1/2	2 ³ / ₄		6 ⁷ / ₁₆	
3	3 ¹ / ₈			
3 1/2	3 ⁷ / ₁₆			
4	3 ⁵ / ₈			

†See compliances for classification of each product.

FE and FT Series

5F

Applications:

FE and FT conduit fittings are installed in hazardous areas to:

- Act as draw-in outlets especially for cables that are stiff due to large size or type of insulation
- Make 90° bends in conduit systems, allowing for a straight pull in either direction
- Provide access to wiring for maintenance and future system changes

Features:

- Maximum volume for bends within a compact overall size
- Large openings to facilitate cable pulling

Certifications and Compliances:

Type of Protection

- Ex d, DIP A21, IP67

Degree of Protection

- IP67

Gas Group

- IIB

Approvals

- Ex1108U

Standard Materials:

- Body – Copper-free aluminum
- Cover – Brass

Standard Finishes:

- Natural

Options:

Description

NPT & BSP thread sizes

Suffix

Consult Factory



Ordering Information:

Inspection Elbows and Tees Selection

Cat. #	Type	Entry Size (metric)
FE1	Elbow	M20 (F)-M20 (F)
FE2	Elbow	M25 (F)-M25 (F)
FT1	Tee	M20 (F)-M20 (F)
FT2	Tee	M25 (F)-M25 (F)

Dimensions (mm)

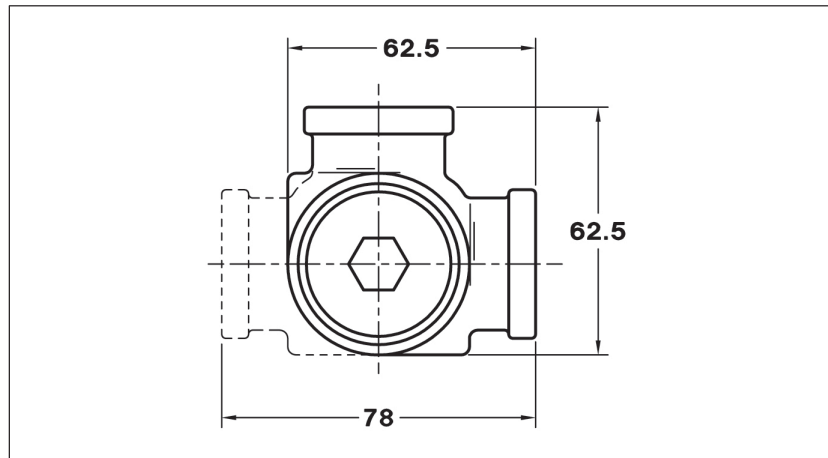

UNF/UNY Expansion Unions

Cl. I, Div. 1 & 2, Groups C, D
 Cl. II, Div. 1, Groups E, F, G
 Cl. II, Div. 2, Groups F, G
 Cl. III

Explosionproof
 Dust-Ignitionproof

5F

Applications:

UNF/UNY expansion unions are designed to be used in all threaded rigid metal† conduit systems indoors and outdoors, in hazardous locations to:

- Connect conduit to conduit
- Connect conduit to a junction box or device enclosure
- Compensate for conduit cut too short
- Allow for expansion and contraction of conduit
- Connect stub-ups to threaded conduit
- Replace sections of conduit runs

Features:

- Compact design
- Internal beryllium copper grounding spring to insure positive grounding continuity.
- Knurled surface on body and sleeve allows secure gripping with wrench.
- Steel construction for maximum strength.
- Available in two styles – short length where space is limited, long length when extra expansion is required.

Certifications and Compliances:

- NEC/CEC:
 - Class I, Division 1 & 2, Groups C, D
 - Class II, Division 1, Groups E, F, G
 - Class II, Division 2, Groups F, G
 - Class III
- UL Standard: 1203
- CSA Standard: C22.2 No. 30

Standard Materials:

- Body and sleeve – steel
- Grounding spring – beryllium copper

Standard Finishes:

- Steel – electrogalvanized with chromate finish
- Beryllium copper – natural

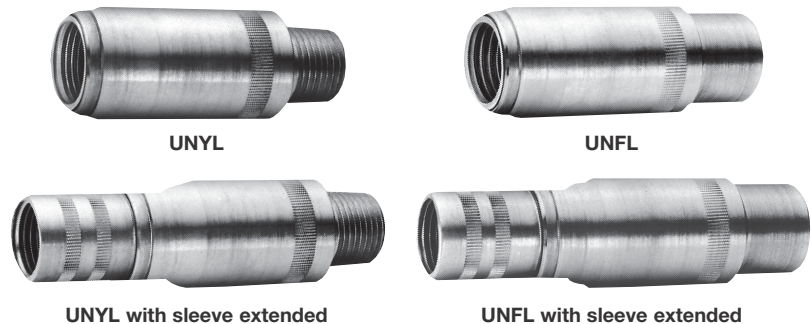

UNY

Male – Short

Conduit Size	Cat. #
1/2	UNY17
3/4	UNY27
1	UNY37

UNYL

Male – Long

Conduit Size	Cat. #
1/2	UNYL17
3/4	UNYL27
1	UNYL37

UNF

Female – Short

Conduit Size	Cat. #
1/2	UNF17
3/4	UNF27
1	UNF37

UNFL

Female – Long

Conduit Size	Cat. #
1/2	UNFL17
3/4	UNFL27
1	UNFL37

Dimensions In Inches:

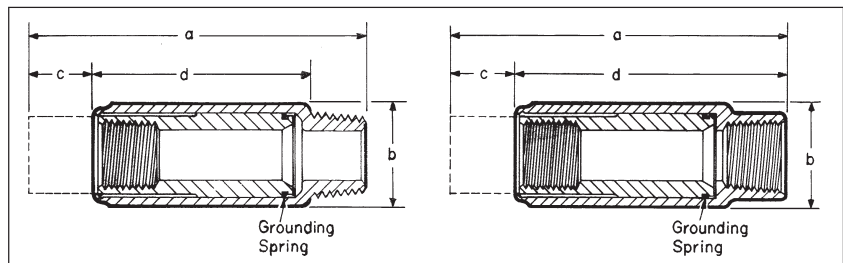

Size	Dimension a*	b	c‡	d
UNY				
1/2	3 ⁵ / ₁₆	1 ³ / ₁₆	1/2	2 ¹ / ₁₆
3/4	3 ⁷ / ₁₆	1 ⁷ / ₁₆	1/2	2 ¹ / ₈
1	3 ¹³ / ₁₆	1 ¹¹ / ₁₆	5/8	2 ¹ / ₄
UNYL				
1/2	4 ⁵ / ₁₆	1 ³ / ₁₆	1	2 ⁹ / ₁₆
3/4	4 ¹ / ₂	1 ⁷ / ₁₆	1 ¹ / ₁₆	2 ¹¹ / ₁₆
1	5 ³ / ₁₆	1 ¹¹ / ₁₆	1 ⁵ / ₁₆	2 ¹⁵ / ₁₆
UNF				
1/2	3 ⁷ / ₁₆	1 ³ / ₁₆	1/2	2 ⁷ / ₁₆
3/4	3 ⁷ / ₁₆	1 ⁷ / ₁₆	1/2	2 ¹⁵ / ₁₆
1	3 ¹³ / ₁₆	1 ¹¹ / ₁₆	5/8	3 ³ / ₁₆
UNFL				
1/2	4 ⁷ / ₁₆	1 ³ / ₁₆	1	3 ³ / ₁₆
3/4	4 ⁹ / ₁₆	1 ⁷ / ₁₆	1 ¹ / ₁₆	3 ¹ / ₂
1	5 ¹ / ₁₆	1 ¹¹ / ₁₆	1 ⁵ / ₁₆	3 ¹³ / ₁₆

*Overall length at maximum expansion

‡Maximum expansion

†Suitable with intermediate Metal Conduit in non-hazardous locations

Crouse-Hinds

by **E.T.N**

5F Reducers, Couplings and Plugs

Cl. I, Div. 1 & 2, Groups A†, B, C, D
 Cl. II, Div. 1, Groups E, F, G
 Cl. II, Div. 2, Groups F, G
 Cl. III

Explosionproof
 Dust-Ignitionproof

5F

Applications:

- RE and REC reducers are used in threaded heavy wall conduit systems.
- RE reduces conduit hubs to a smaller size.
- REA adapters enlarge drilled and tapped openings by 1 NPT size.
- REC connects two different sizes of conduit together or is used to replace a coupling and reducer in an installation.
- PLG plugs are used for closing threaded conduit hubs.

Features:

RE reducers have:

- Integral bushing which prevents damage to wires

- Full, clean cut tapered threads

REC reducers have:

- Integral bushings in both ends which prevents damage to wires
- Funnel shaped interior to guide the wires from large to small conduit, making it easy to pull wire

REA adapters have:

- Smooth integral bushing to protect wire insulation

- Knurled body for easy wrenching

PLG plugs:

- Have clean tapered threads
- Are available in two styles, flush (recessed), or square head type

Certifications and Compliances:

- NEC/CEC:
 - Class I, Division 1 & 2, Groups A, B, C, D
 - Class II, Division 1, Groups E, F, G
 - Class II, Division 2, Groups F, G
 - Class III

(see listings for specific Cat. Nos. suitable for Groups A or B)

- UL Standard: 1203
- CSA Standard: C22.2 No. 30

Standard Materials:

- RE reducers – RE1108 through RE54 in steel; all others in *Feraloy*® iron alloy
- REA adapters – steel
- REC reducers – REC21 and REC32 in steel; all others in *Feraloy* iron alloy
- PLG plugs – Recessed: PLG28-PLG3: steel, PLG4-PLG10: grey iron alloy; Square Head: PLG15-PLG55: steel, PLG65-PLG105: grey iron alloy

Standard Finishes:

- Feraloy* iron alloy – electrogalvanized and aluminum acrylic paint
- Steel – electrogalvanized with chromate treatment

Options:

Description	Suffix
Copper-free aluminum	SA

RE



Size	Cat. #
1/2 - 1/8	RE1108*
1/2 - 1/4	RE1208*
1/2 - 3/8	RE1308
3/4 - 1/2	RE21†
1 - 1/2	RE31†
1 - 3/4	RE32†
1 1/4 - 1/2	RE41†
1 1/4 - 3/4	RE42†
1 1/4 - 1	RE43†
1 1/2 - 1/2	RE51†
1 1/2 - 3/4	RE52†
1 1/2 - 1	RE53†
1 1/2 - 1 1/4	RE54†
2 - 1/2	RE61†
2 - 3/4	RE62†
2 - 1	RE63†
2 - 1 1/4	RE64†
2 - 1 1/2	RE65†
2 1/2 - 1	RE73†
2 1/2 - 1 1/4	RE74†
2 1/2 - 1 1/2	RE75†
2 1/2 - 2	RE76†
3 - 1	RE83†
3 - 1 1/4	RE84†
3 - 1 1/2	RE85†
3 - 2	RE86†
3 - 2 1/2	RE87†
3 1/2 - 2	RE96†
3 1/2 - 2 1/2	RE97†
3 1/2 - 3	RE98†
4 - 2	RE106†
4 - 2 1/2	RE107†
4 - 3	RE108†
4 - 3 1/2	RE109†
5 - 4	RE01210
6 - 5	RE01412

REC



Large Hub Size	Small Hub Size	Cat. #
3/4	1/2	REC21†
1	1/2	REC31†
1	3/4	REC32
1 1/4	3/4	REC42
1 1/4	1	REC43
1 1/2	3/4	REC52
1 1/2	1	REC53
1 1/2	1 1/4	REC54
2	3/4	REC602
2	1	REC603
2	1 1/4	REC604
2	1 1/2	REC605
2 1/2	1 1/2	REC75
3	2	REC86
3 1/2	2 1/2	REC97*
4	3	REC108*
5	4	REC01210*

REA



Male Hub Size	Female Hub Size	Cat. #
1/2	3/4	REA12†
3/4	1	REA23†
1	1 1/4	REA34†

PLG



Recessed



Square Head

Recessed

Size	Cat. #
1/4	PLG28†
1/2	PLG1†
3/4	PLG2†
1	PLG3†
1 1/4	PLG4
1 1/2	PLG5
2	PLG6
2 1/2	PLG7
3	PLG8
3 1/2	PLG9
4	PLG10

Square Head

Size	Cat. #
1/2	PLG15†
3/4	PLG25†
1	PLG35†
1 1/4	PLG45
1 1/2	PLG55
2	PLG65
2 1/2	PLG75
3	PLG85
3 1/2	PLG95
4	PLG105

*Not available in aluminum.

†Suitable for use in Class I, Groups A and B areas.

AMN / ANM Adapters For IEC Applications

Zone 1
Zone 2

Zone 21
Zone 22

5F

5F

Application:

Adapters are used to change the thread form and/or size in a wide range of BSP, NPT, and metric cable and conduit entries.

Certifications and Compliances:

- Type of Protection
- Ex d, DIP A21, IP67
- Degree of Protection
- IP66/67
- Gas Group
- IIC
- Approvals
- Ex1108U

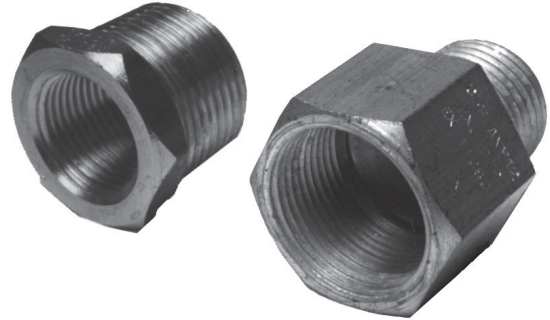

Standard Materials:

- Brass, nickel plated

Standard Finish:

- Natural

Options:

Stainless Steel - Replace NP with SS

Size Ranges:

- Standard sizes listed in table below; other sizes may be available; please consult factory

Notes:

1. Adapters have different size thread at each end
2. Adapters may step up the same type of thread
3. Downwards adapters are Type A; upward or same size adapters are Type B
4. For downward adapters of same thread type, see Reducers Catalog Page
5. For same size and type of thread, see Unions Catalog Page

Ordering Information:

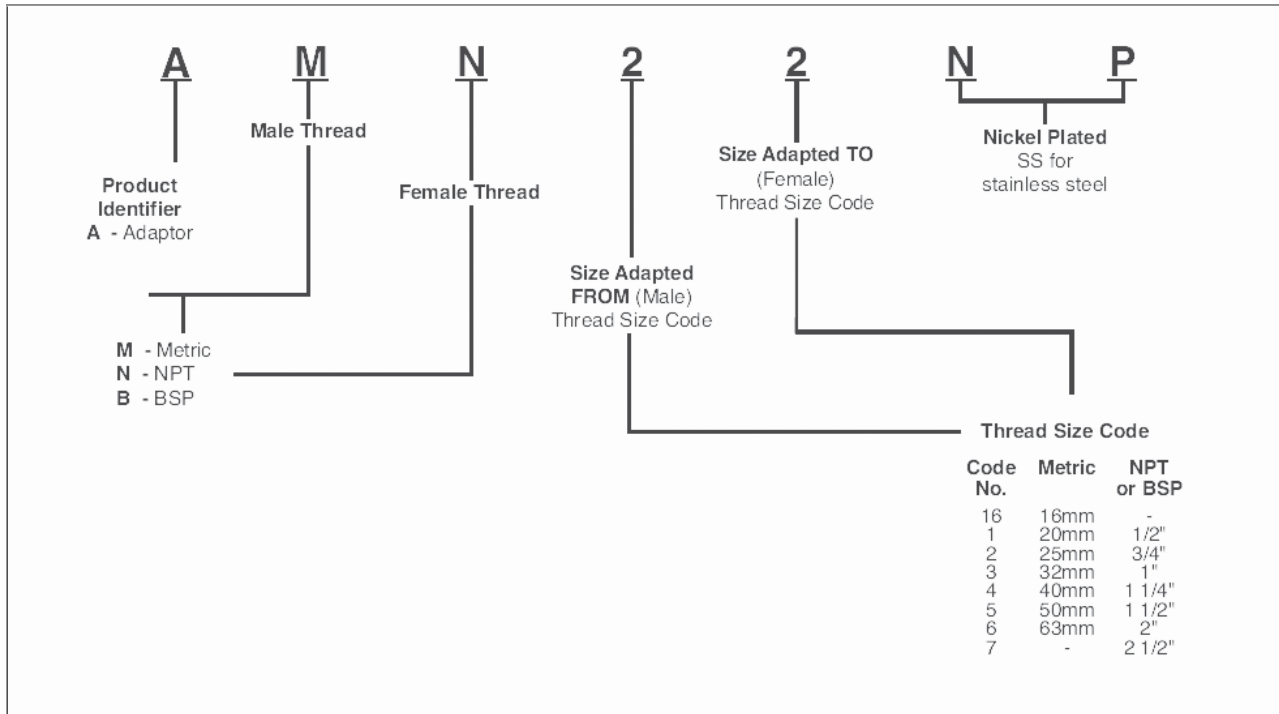

5F

Applications:

- Reducers are used in threaded heavy wall conduit systems to reduce conduit hubs to a smaller size or to connect two different sizes of conduit together
- Adapters enlarge drilled and tapped openings by 1 NPT size
- Plugs are used for closing unused threaded conduit hubs

Features:

Reducers:

- Integral bushing which prevents damage to wires
- Full, clean cut tapered threads
- Funnel shaped interior to guide the wires from large to small conduit, making it easy to pull wire

Adapters:

- Smooth integral bushing to protect wire insulation
- Knurled body for easy wrenching

Plugs:

- Full, clean cut tapered threads

Certifications and Compliances:

- Plugs:
 - Ex II 2 G EEx e II
 - Ex II 2 G EEx d IIC
 - EC-Type examination certificate LOM 02 ATEX 3035U
 - IP67
- Reducers and Adapters:
 - Ex II 2 G EEx e II
 - Ex II 2 G EEx d IIC
 - Ex II 2 D
 - EC-Type examination certificate LOM 03 ATEX 3019U
 - IP67
- Nipples:
 - Ex II 2 G EEx d IIC
 - EC-Type examination certificate LOM 03 ATEX 3019U
 - IP67

Standard Materials:

- Reducers, Adapters, Plugs and Nipples - Zinc Plated Steel

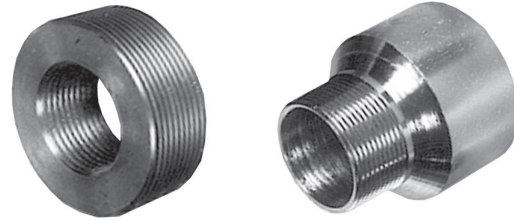

Ordering Information - Reducers

Male Thread	Female Thread	Cat. #
3/4" ISO 7/8	1/2" ISO 7/8	NOR 000 002 190 112
1" ISO 7/8	3/4" ISO 7/8	NOR 000 002 190 188
1/2" ISO 7/8	3/4" ISO 7/8	NOR 000 002 190 675
3/4" ISO 7/8	1" ISO 7/8	NOR 000 002 190 740

Ordering Information - Adapters

Male Thread	Female Thread	Cat. #
M20 x 1.5	1/2" ISO 7/8	NOR 000 112 190 010
PG13	1/2" ISO 7/8	NOR 000 112 190 015
PG16	1/2" ISO 7/8	NOR 000 112 190 014
M20 x 1.5	3/4" ISO 7/8	NOR 000 112 190 009
M25 x 1.5	3/4" ISO 7/8	NOR 000 112 190 008
PG13	3/4" ISO 7/8	NOR 000 112 190 013
PG16	3/4" ISO 7/8	NOR 000 112 190 012
PG21	3/4" ISO 7/8	NOR 000 112 190 011
1/2" ISO 7/8	M20 x 1.5	NOR 000 112 190 002
3/4" ISO 7/8	M20 x 1.5	NOR 000 112 190 001
PG13	M20 x 1.5	NOR 000 112 190 017
PG16	M20 x 1.5A	NOR 000 112 190 016
3/4" ISO 7/8	M25 x 1.5	NOR 000 112 190 000
PG16	M25 x 1.5	NOR 000 112 190 020
1/2" ISO 7/8	PG13	NOR 000 112 190 007
3/4" ISO 7/8	PG13	NOR 000 112 190 005
1/2" ISO 7/8	PG16	NOR 000 112 190 006
3/4" ISO 7/8	PG16	NOR 000 112 190 004
M20 x 1.5	PG16	NOR 000 112 190 018
M25 x 1.5	PG16	NOR 000 112 190 019
3/4" ISO 7/8	PG21	NOR 000 112 190 003



Ordering Information - Plugs

Thread Size	Cat. #
1/2" ISO 7/8	NOR 000 002 140 117
3/4" ISO 7/8	NOR 000 002 140 125
1" ISO 7/8	NOR 000 002 140 133
1" NPT	NOR 000 002 140 365
M20 x 1.5	NOR 000 002 140 655
M25 x 1.5	NOR 000 002 140 656
M32 x 1.5	NOR 000 002 140 657
M50 x 1.5	NOR 000 002 140 658
M60 x 1.5	NOR 000 002 140 659

Type PLG

Ordering Information - Nipples

Thread Size	Type	Cat. #
1/2" ISO 7/8	EMM 1	NOR 000 002 130 118
3/4" ISO 7/8	EMM 2	NOR 000 002 130 126
1" ISO 7/8	EMM 3	NOR 000 002 130 134
1/2" ISO 7/8	EMF 1	NOR 000 002 130 217
3/4" ISO 7/8	EMF 2	NOR 000 002 130 225
1" ISO 7/8	EMF 3	NOR 000 002 130 233

Couplings

Cl. I, Groups A, B, C, D
Cl. II, Groups E, F, G
Cl. III

Explosionproof
Dust-Ignitionproof
Wet Locations

5F

1/2"-2" Brass Construction
2-1/2"-4" Stainless Steel construction only

Applications:

EC couplings are used:

- In hazardous areas where a flexible member is required in a conduit system to accomplish difficult bends, or to allow for movement or vibration of connected equipment or units

Features:

- Rugged design to withstand explosive pressure (Class I)
- Mechanical abuse
- Liquid-tight for wet locations
- For use where lack of space makes use of rigid conduit difficult
- Wire duct liner in sizes 1/2" to 2" insulates against grounds and burn-through from short circuit
- No bonding jumpers required, metallic braid provides continuous electrical path
- ECGJH combination has two threaded male end fittings
- ECLK combination has one female union and one male threaded end fitting

Certifications and Compliances:

- NEC:
 - 1/2" and 3/4" (Brass and S516) – Class I, Division 1, Groups A, B, C, D
 - 1" to 2" (Brass and S516) – Class I, Division 1, Groups C, D
- All sizes also for use in Class II, Division 1, Groups E, F, G and Class III
- UL Standard: 1203
- ATEX and IECEx - **ECGJH S516 Only:**
 - 1/2" and 3/4" (4" to 36" flexible length only) – Ex d IIC, IP66
 - 1", 1 1/4", 1 1/2", 2" (4" to 36" flexible length only) – Ex d IIB, IP66

Standard Materials and Finishes:

- End fittings:
 - 1/2" to 2" – forged brass; natural
 - 2 1/2" to 4" – stainless steel; natural
- Female unions:
 - 1/2" to 1" – steel; electrogalvanized with chromate treatment
 - 1 1/4" to 4" – *Feraloy*® iron alloy; electrogalvanized with aluminum acrylic paint
- 1/2" to 2" have bronze braid covering and flexible brass inner core; packing is woven cotton braid impregnated with asphalt
- 2 1/2" to 4" have a Type 304 stainless steel braid

Options:

Description

All stainless steel (available for ECGJH only)

For severely corrosive locations, a flexible PVC protective coating will be supplied

Special coupling lengths available up to 144 inches. To order, change last two digits in any standard catalog number to the two or three digit length desired in whole inches i.e. To order a 3/4" trade size 110 inches long, use catalog number ECGJH2110.



ECGJH (Male connections both ends)

Flexible Length (In.)	Size	Cat. #	Flexible Length (In.)	Size	Cat. #	Flexible Length (In.)	Size	Cat. #
4	1/2	ECGJH14	18	1	ECGJH318	27	2 1/2	ECGJH727
4	3/4	ECGJH24	18	1 1/4	ECGJH418	27	3	ECGJH827
6	1/2	ECGJH16	18	1 1/2	ECGJH518	27	4	ECGJH1027
6	3/4	ECGJH26	18	2	ECGJH618	30	1/2	ECGJH130
6	1	ECGJH36	18	2 1/2	ECGJH718	30	3/4	ECGJH230
8	1/2	ECGJH18	18	3	ECGJH818	30	1	ECGJH330
8	3/4	ECGJH28	18	4	ECGJH1018	30	1 1/4	ECGJH430
8	1	ECGJH38	21	1/2	ECGJH121	30	1 1/2	ECGJH530
10	1/2	ECGJH110	21	3/4	ECGJH221	30	2	ECGJH630
10	3/4	ECGJH210	21	1	ECGJH321	30	2 1/2	ECGJH730
10	1	ECGJH310	21	1 1/4	ECGJH421	30	3	ECGJH830
12	1/2	ECGJH112	21	1 1/2	ECGJH521	30	4	ECGJH1030
12	3/4	ECGJH212	21	2	ECGJH621	33	1/2	ECGJH133
12	1	ECGJH312	21	2 1/2	ECGJH721	33	3/4	ECGJH233
12	1 1/4	ECGJH412	21	3	ECGJH821	33	1	ECGJH333
12	1 1/2	ECGJH512	21	4	ECGJH1021	33	1 1/4	ECGJH433
12	2	ECGJH612	24	1/2	ECGJH124	33	1 1/2	ECGJH533
12	2 1/2	ECGJH712	24	3/4	ECGJH224	33	2	ECGJH633
12	3	ECGJH812	24	1	ECGJH324	33	2 1/2	ECGJH733
12	4	ECGJH1012	24	1 1/4	ECGJH424	33	3	ECGJH833
15	1/2	ECGJH115	24	1 1/2	ECGJH524	33	4	ECGJH1033
15	3/4	ECGJH215	24	2	ECGJH624	36	1/2	ECGJH136
15	1	ECGJH315	24	2 1/2	ECGJH724	36	3/4	ECGJH236
15	1 1/4	ECGJH415	24	3	ECGJH824	36	1	ECGJH336
15	1 1/2	ECGJH515	24	4	ECGJH1024	36	1 1/4	ECGJH436
15	2	ECGJH615	27	1/2	ECGJH127	36	1 1/2	ECGJH536
15	2 1/2	ECGJH715	27	3/4	ECGJH227	36	2	ECGJH636
15	3	ECGJH815	27	1	ECGJH327	36	2 1/2	ECGJH736
15	4	ECGJH1015	27	1 1/4	ECGJH427	36	3	ECGJH836
18	1/2	ECGJH118	27	1 1/2	ECGJH527	36	4	ECGJH1036
18	3/4	ECGJH218	27	2	ECGJH627			

Dimensions In Inches:

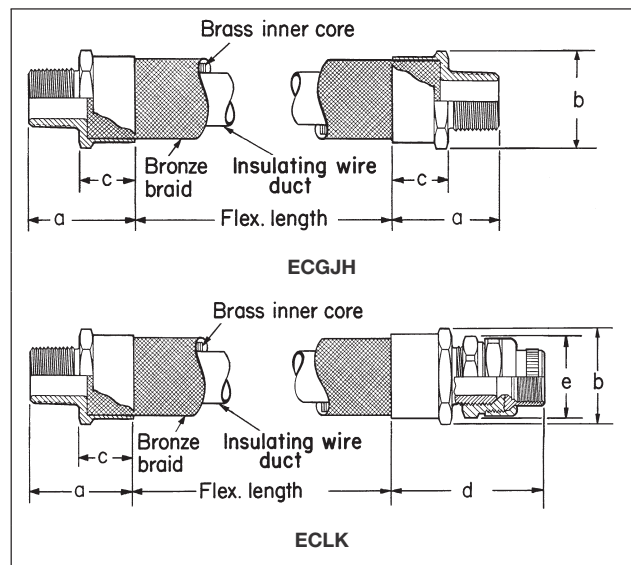

Crouse-Hinds

by **E.T.N**

5F

5F

Couplings

Cl. I, Groups A, B, C, D
Cl. II, Groups E, F, G
Cl. III

Explosionproof
Dust-Ignitionproof
Wet Locations

1/2"-2" Brass Construction
2-1/2-4" Stainless Steel construction only

5F



ECLK (ECGJH provide with UNF Female union – male connection 1 end, female connection 1 end)

Flexible Length (In.)	Size	Cat. #	Flexible Length (In.)	Size	Cat. #	Flexible Length (In.)	Size	Cat. #
4	1/2	ECLK14	18	1	ECLK318	27	2 1/2	ECLK727
4	3/4	ECLK24	18	1 1/4	ECLK418	27	3	ECLK827
6	1/2	ECLK16	18	1 1/2	ECLK518	27	4	ECLK1027
6	3/4	ECLK26	18	2	ECLK618	30	1/2	ECLK130
6	1	ECLK36	18	2 1/2	ECLK718	30	3/4	ECLK230
8	1/2	ECLK18	18	3	ECLK818	30	1	ECLK330
8	3/4	ECLK28	18	4	ECLK1018	30	1 1/4	ECLK430
8	1	ECLK38	21	1/2	ECLK121	30	1 1/2	ECLK530
10	1/2	ECLK110	21	3/4	ECLK221	30	2	ECLK630
10	3/4	ECLK210	21	1	ECLK321	30	2 1/2	ECLK730
10	1	ECLK310	21	1 1/4	ECLK421	30	3	ECLK830
12	1/2	ECLK112	21	1 1/2	ECLK521	30	4	ECLK1030
12	3/4	ECLK212	21	2	ECLK621	33	1/2	ECLK133
12	1	ECLK312	21	2 1/2	ECLK721	33	3/4	ECLK233
12	1 1/4	ECLK412	21	3	ECLK821	33	1	ECLK333
12	1 1/2	ECLK512	21	4	ECLK1021	33	1 1/4	ECLK433
12	2	ECLK612	24	1/2	ECLK124	33	1 1/2	ECLK533
12	2 1/2	ECLK712	24	3/4	ECLK224	33	2	ECLK633
12	3	ECLK812	24	1	ECLK324	33	2 1/2	ECLK733
12	4	ECLK1012	24	1 1/4	ECLK424	33	3	ECLK833
15	1/2	ECLK115	24	1 1/2	ECLK524	33	4	ECLK1033
15	3/4	ECLK215	24	2	ECLK624	36	1/2	ECLK136
15	1	ECLK315	24	2 1/2	ECLK724	36	3/4	ECLK236
15	1 1/4	ECLK415	24	3	ECLK824	36	1	ECLK336
15	1 1/2	ECLK515	24	4	ECLK1024	36	1 1/4	ECLK436
15	2	ECLK615	27	1/2	ECLK127	36	1 1/2	ECLK536
15	2 1/2	ECLK715	27	3/4	ECLK227	36	2	ECLK636
15	3	ECLK815	27	1	ECLK327	36	2 1/2	ECLK736
15	4	ECLK1015	27	1 1/4	ECLK427	36	3	ECLK836
18	1/2	ECLK118	27	1 1/2	ECLK527	36	4	ECLK1036
18	3/4	ECLK218	27	2	ECLK627			

ECGJH and ECLK

Size	a	b	c	d	e
1/2	1 1/8	1 1/2	1 1/8	3	1 9/16
3/4	2 1/16	1 7/8	1 3/16	3 1/4	1 13/16
1	2 1/2	2 1/8	1 1/2	3 3/8	1 7/8
1 1/4	2 7/8	2 15/16	1 7/8	4 3/16	2 3/4
1 1/2	3 5/16	3 1/2	1 7/8	5 1/16	3 1/16
2	3 3/4	4 1/4	2	5 1/16	3 13/16
2 1/2	3	4 7/16	1 5/8	5 1/16	4 5/16
3	3 3/8	4 9/16	1 3/4	5 5/8	5 1/16
4	4 3/8	4 15/16	3 1/4	7 1/2	6 3/16

Minimum Recommended Radius of Bend

Size	Radius	Size	Radius
1/2	10	2	16
3/4	12	2 1/2	16
1	14	3	18
1 1/4	14	4	30
1 1/2	16		

Applications:

XD couplings can be installed indoors, outdoors, buried underground, or embedded in concrete in non-hazardous areas. XD's are used with standard rigid conduit or PVC rigid conduit. (PVC requires rigid metal conduit nipples and rigid metal-to-PVC conduit adapters.) XD's provide a flexible and watertight connection for protection of conduit wiring systems from damage due to movement.

Typical applications include:

- Underground conduit feeder runs
- Runs between sections of concrete subject to relative movement
- Runs between fixed structures
- Conduit entrances in high-rise buildings
- Bridges
- Marinas, docks, piers

Features:

- XD couplings accommodate the following movements without collapsing or fracturing the conduit, and damaging the wires it contains:
 1. Axial expansion or contraction up to 3/4"
 2. Angular misalignment of the axes of the coupled conduit runs in any direction to 30°
 3. Parallel misalignment of the axes of coupled conduit runs in any direction to 3/4"
- Inner sleeve maintains constant I.D. in any position and provides a smooth insulated wireway for protection of wire insulation
- Watertight flexible neoprene outer jacket is corrosion resistant and protects the grounding strap and the attachment points of the hubs
- Tinned copper flexible braid grounding straps assure grounding continuity
- Stainless steel jacket clamps for strength and corrosion resistance
- Standard tapered electrical threads fit standard rigid conduit
- Integral hub bushing protects insulation of conductors

Certifications and Compliances:

- UL Standard: 514B

Standard Materials:

- Hubs – *Feraloy*® iron alloy
- Outer jacket – molded neoprene
- Jacket clamps – stainless steel
- Inner sleeve – molded plastic
- Grounding straps – tinned copper flexible braid

Standard Finishes:

- *Feraloy* – electrogalvanized
- Neoprene – natural (black)
- Molded plastic – natural (brown)

Options:

Description	Suffix
Hot dipped galvanized	HDG

Size Ranges:

- 1" to 6" (Smaller sizes can be obtained by using reducing bushings)

Crouse-Hinds

by **E•T•N**

XD

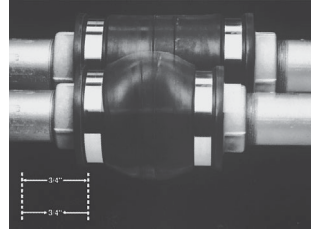

1. Axial expansion/contraction.

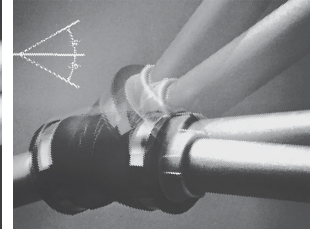

2. Angular misalignment.

Ordering Information

Hub Size	Cat. #	Hub Size	Cat. #
1	XD3	3	XD8
1 1/4	XD4	3 1/2	XD9
1 1/2	XD5	4	XD010
2	XD6	5	XD012
2 1/2	XD7	6	XD014

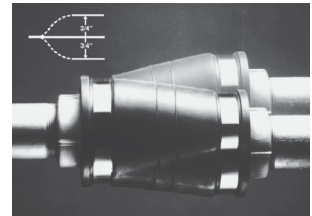

3. Parallel misalignment.

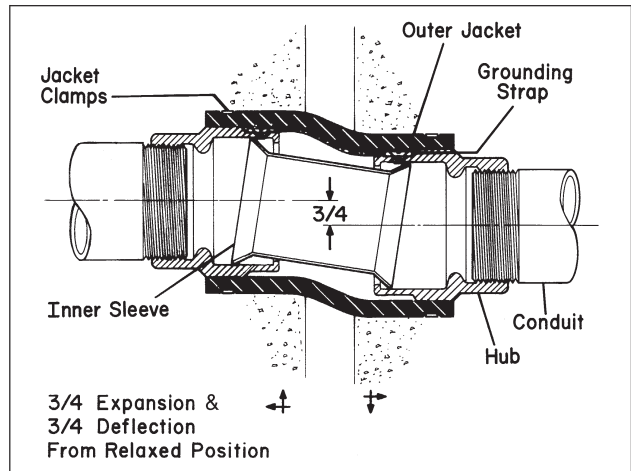

Dimensions In Inches:

Hub Size	a	b
1	7	3 15/16
1 - 1/4	7 3/8	4 1/4
1 1/2	7 1/4	4 1/2
2	7 1/4	4 15/16
2 1/2	7 1/2	5 5/16
3	7 5/8	5 15/16
3 1/2	7 3/4	6 1/2
4	7 7/8	6 15/16
5	7 3/4	8
6	8 3/8	9

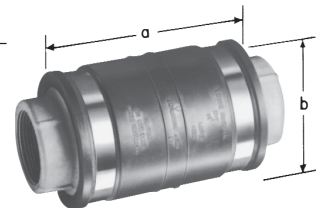

5F XJG Conduit Expansion Joints With Internal Grounding For Rigid Metal Conduit and IMC

Wet Locations

5F

Applications:

XJG expansion couplings are used with rigid metal conduit and IMC:

- Without the need for an external bonding jumper and clamps (up to 4")
- To couple together two (2) sections of conduit subject to longitudinal movement
- In long conduit runs to permit linear movement caused by thermal expansion and contraction
- On long conduit runs to prevent conduit from buckling and ensuing circuit failures
- Indoors or outdoors where conduit expansion occurs and there are wide temperature ranges
- In conduit runs that cross structural joints
- In conduit runs to prevent damage to conduit supports such as in a building or on a bridge
- With optional redundant visible grounding strap

Certifications and Compliances:

- UL Standard: 514B
- CSA Standard: C22.2 No. 18
- NEC Articles 250-77 and 300-7 (b)
- NEMA FB1
- Wet Locations

Standard Materials and Finishes:

Body

- Steel - electrogalvanized
- Copper-free aluminum - natural
- *Feraloy*[®] iron alloy - electrogalvanized (5" + 6" only)

Reducer

- 1/2" through 1" - Steel - electrogalvanized
- 1 1/4" through 6" - *Feraloy*[®] iron alloy - electrogalvanized and aluminum paint
- Copper-free aluminum - natural

Gland Nut

- 1/2" through 1" - Steel - electrogalvanized
- 1 1/4" through 6" - *Feraloy*[®] iron alloy - electrogalvanized and aluminum paint
- Copper-free aluminum - natural

Packing

- Teflon[®] (trademark of E.I. DuPont Co.)

Washer

- Steel - electrogalvanized
- Copper-free aluminum - natural

Gasket

- Vellum

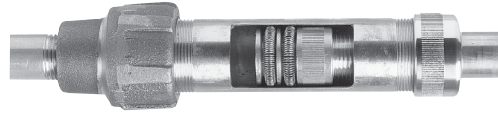

Patented Design

Ordering Information

Conduit Size	Maximum Conduit Movement	Cat. #	Optional Bonding Jumper†	A Diameter	B Length	Bonding Jumper Length
1/2	4	XJG14	BJ14	1.75	6.75	20"
	8	XJG18	BJ18	1.75	10.75	30"
3/4	4	XJG24	BJ24	2.12	6.75	20"
	8	XJG28	BJ28	2.12	10.75	30"
1	4	XJG34	BJ34	2.43	7.25	20"
	8	XJG38	BJ38	2.43	11.25	30"
1 1/4	4	XJG44	BJ44	3.19	7.56	24"
	8	XJG48	BJ48	3.19	11.56	30"
1 1/2	4	XJG54	BJ54	3.68	7.87	24"
	8	XJG58	BJ58	3.68	11.87	30"
2	4	XJG64	BJ64	4.75	8.25	24"
	8	XJG68	BJ68	4.75	12.25	30"
2 1/2	4	XJG74	BJ74	4.87	9.31	24"
	8	XJG78	BJ78	4.87	13.31	36"
3	4	XJG84	BJ84	5.37	10.00	30"
	8	XJG88	BJ88	5.37	14.00	36"
3 1/2	4	XJG94	BJ94	6.62	9.81	30"
	8	XJG98	BJ98	6.62	13.81	36"
4	4	XJG104	BJ104	6.62	9.81	30"
	8	XJG108	BJ108	6.62	13.81	36"
5	8	XJ128‡	—	7.64	15.50	—
6	8	XJ148‡	—	9.56	16.00	—

†XJG expansion couplings use a metallic bushing and ground springs to create a high integrity internal ground connection. External ground straps offer a redundant ground path and easy visible indication of ground.

‡XJ128 and XJ148 are not internally grounded. A pair of 36" bonding jumpers are provided with fitting.

Bushing

- 1/2" through 1" - Steel - electrogalvanized
- 1 1/4" through 6" - *Feraloy*[®] iron alloy - electrogalvanized and aluminum paint
- Copper-free aluminum - natural

Ground Springs

- Phosphor bronze - electrogalvanized

Ground Strap

- Braided tinned copper

U-Bolts

- Malleable iron - electrogalvanized

Options:

Description

Available in copper-free aluminum
Not available on 5" and 6" sizes

Hot dipped galvanized

Available with redundant† ground strap for visible indication of grounding – order separately (BJ Series)

Size Ranges:

- 1/2" through 6" conduit size
- 4" and 8" maximum conduit movement

Dimensions In Inches:

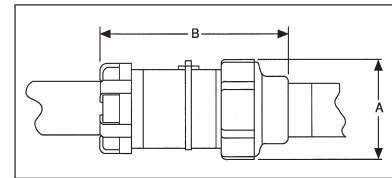

XJG shown with optional bonding jumper

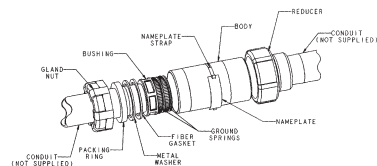

Crouse-Hinds
by E.T.N

XJG-EMT Conduit Expansion Joints With Internal Grounding For EMT Conduit



Applications:

- XJG expansion couplings are used with EMT Conduit:
- Without the need for an external bonding jumper and clamps
 - To couple together two (2) sections of conduit subject to longitudinal movement
 - In long conduit runs to permit linear movement caused by thermal expansion and contraction
 - On long conduit runs to prevent conduit from buckling and ensuing circuit failures
 - Indoors or outdoors where conduit expansion occurs and there are wide temperature ranges
 - In conduit runs that cross structural joints
 - In conduit runs to prevent damage to conduit supports such as in a building or on a bridge
 - With optional redundant visible grounding strap

Certifications and Compliances:

- UL Standard: 514B
- CSA Standard: C22.2 No. 18
- NEC Articles 250-77 and 300-7 (b)
- NEMA FB1

Standard Materials and Finishes:

Body

- Steel - electrogalvanized
- Copper-free aluminum - natural

Reducer

- 1/2" through 1" - Steel - electrogalvanized
- 1 1/4" through 4" - *Feraloy*[®] iron alloy - electrogalvanized and aluminum paint

Gland Nut

- 1/2" through 1" - Steel - electrogalvanized
- 1 1/4" through 4" - *Feraloy*[®] iron alloy - electrogalvanized and aluminum paint

Packing

- Teflon[®] (trademark of E.I. DuPont Co.)

Washer

- Steel - electrogalvanized

Gasket

- Vellum

Bushing

- 1/2" through 1" - Steel - electrogalvanized
- 1 1/4" through 4" - *Feraloy*[®] iron alloy - electrogalvanized and aluminum paint

Ground Springs

- Phosphor bronze - electrogalvanized

Ground Strap

- Braided tinned copper

U-Bolts

- Malleable iron – electrogalvanized

Crouse-Hinds

by **E.T.N**

Options:

Available with redundant† ground strap for visible indication of grounding – order separately (BJ Series)

Size Ranges:

- 1/2" through 4" conduit size
- 4" maximum conduit movement

Ordering Information

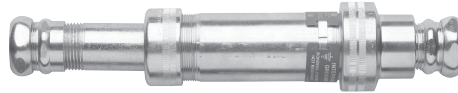

Conduit Size	Maximum Conduit Movement	Cat. #	Optional Bonding Jumper	A Diameter	B Length
1/2"	4"	XJG14 EMT	BJ14	1 3/4"	10 3/4"
3/4"	4"	XJG24 EMT	BJ24	2 1/8"	11"
1"	4"	XJG34 EMT	BJ34	2 7/16"	11 1/2"
1 1/4"	4"	XJG44 EMT	BJ44	3 3/8"	15 1/4"
1 1/2"	4"	XJG54 EMT	BJ54	3 5/8"	15 1/2"
2"	4"	XJG64 EMT	BJ64	4 3/4"	15 1/2"
2 1/2"	4"	XJG74 EMT	BJ74	4 7/8"	18 3/4"
3"	4"	XJG84 EMT	BJ84	5 3/8"	19 7/8"
3 1/2"	4"	XJG94 EMT	BJ94	6 3/8"	21 1/4"
4"	4"	XJG104 EMT	BJ104	6 5/8"	21 1/4"



XJG shown with optional bonding jumper

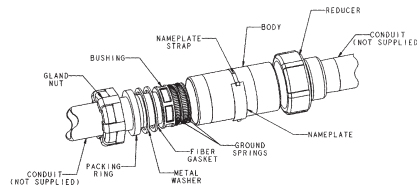

†XJG expansion couplings use a metallic bushing and ground springs to create a high integrity internal ground connection. External ground straps offer a redundant ground path and easy visible indication of ground.

XJGD Combination Expansion/Deflection Coupling and Expansion Joint Internally Grounded

Applications:

XJGD combination fittings are used with rigid metal conduit and IMC:

- To accommodate axial expansion, angular misalignment and parallel misalignment
- To couple together two (2) sections of conduit subject to longitudinal movement
- To maintain a ground connection without the need for an external bonding jumper and clamps
- In long conduit runs to prevent conduit from buckling and causing circuit failures
- Indoors or outdoors where conduit expansion occurs and there are wide temperature swings
- In conduit runs that cross structural joints
- In conduit runs to prevent damage to conduit supports such as in a building or on a bridge

Certifications and Compliances:

- UL Standard: 514B

Standard Materials:

- Body, Hubs, Gland Nut, Washer, Bushing – *Feraloy*[®]
- Packing – Teflon[®]
- Gasket – vellum
- Ground Spring – phosphor bronze
- Outer Jacket – molded neoprene
- Jacket Clamps – stainless steel
- Inner Sleeve – molded plastic
- Ground Straps – tinned copper braid

Standard Finishes:

- *Feraloy*[®] – electrogalvanized

Ordering Information



Hub Size	Maximum Conduit Movement	Cat. #	A Diameter	B Length
1"	4"	XJGD34	3 ¹⁵ / ₁₆ "	17 ³ / ₄ "
1 ¹ / ₄ "	4"	XJGD44	4 ¹ / ₄ "	18 ¹ / ₈ "
1 ¹ / ₂ "	4"	XJGD54	4 ¹ / ₂ "	18 ⁵ / ₈ "
2"	4"	XJGD64	4 ¹⁵ / ₁₆ "	19 ¹ / ₄ "
2 ¹ / ₂ "	4"	XJGD74	5 ³ / ₁₆ "	20 ³ / ₄ "
3"	4"	XJGD84	5 ¹⁵ / ₁₆ "	21 ⁵ / ₈ "
3 ¹ / ₂ "	4"	XJGD94	6 ¹ / ₂ "	21 ¹ / ₈ "
4"	4"	XJGD104	8"	27 ³ / ₄ "

(Also see Myers Hubs see page 211)

Applications:

HUB Conduit Hubs:

- Provide a convenient means for installing a threaded conduit hub on a junction box or device enclosure
- Are used to connect conduit to a sheet metal or cast enclosure
- Are used with threaded rigid conduit or IMC, steel or aluminum; indoors or outdoors

Features:

- Smooth insulated throat provides easier wire pulling and protection for conductors during installation.
- Neoprene sealing gasket provides a watertight seal.
- Compact design permits close spacing of conduit.
- Wide range of sizes from 1/2" to 4".

Certifications and Compliances:

- UL Standard: 514B
- CSA Standard: C22.2 No. 18
- NEC/CEC:
 - Class I, Division 2, Groups A, B, C, D
 - Per NEC 501-4(b), 502-4(a) and 503-3(a)

Standard Materials:

- 1/2" to 4" malleable iron

Standard Finishes:

- *Feraloy* iron alloy – electrogalvanized and aluminum acrylic paint

Size Ranges:

- 1/2" to 4"

Ordering Information

Conduit Size	Cat. #
1/2	HUB1
3/4	HUB2
1	HUB3
1 1/4	HUB4
1 1/2	HUB5
2	HUB6
2 1/2	HUB7
3	HUB8
3 1/2	HUB9
4	HUB10

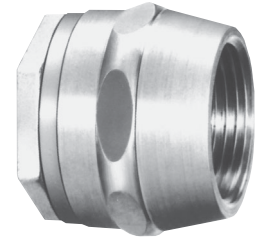

Dimensions In Inches:

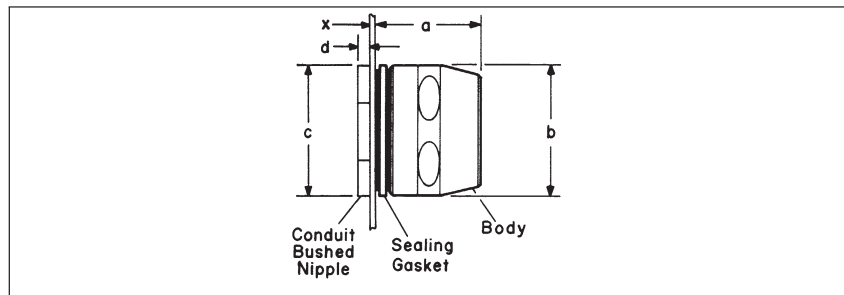

Cat. #	Conduit Size	a	b	c	d	x
HUB1	1/2	1	1 1/4	1	1/8	9/64
HUB2	3/4	1 1/8	1 9/16	1 3/8	5/32	1/4
HUB3	1	1 3/8	1 7/8	1 5/8	3/16	9/32
HUB4	1 1/4	1 1/2	2 5/16	2	1/4	7/16
HUB5	1 1/2	1 5/8	2 1/2	2 3/8	1/4	7/16
HUB6	2	1 11/16	3	2 13/16	1/4	7/16
HUB7	2 1/2	2 3/16	3 5/8	3 7/16	1/4	7/16
HUB8	3	2 7/16	4 1/4	4 1/16	1/4	7/16
HUB9	3 1/2	2 7/16	4 3/4	4 11/16	5/16	3/4
HUB10	4	2 9/16	5 1/4	5 1/16	5/16	1 1/8

Dimension "x" is maximum wall thickness of box that will meet the requirement for three full threads engagement of nipple and fitting body when liquidtight box connector or rigid conduit hub is installed in a knockout or slip hole.

5F Grounding Devices Straps and Clamps

5F

Applications:

- GCR grounding receptacles are used to provide static electricity grounding connections; particularly suited for, but not limited to, use in aircraft hangar floors and airport aprons.
- GCT ground connector and studs are used to provide "quick-connect" static electricity grounding connections with portable cable.
- GC grounding strap and clamp are suitable for bonding and grounding equipment in wiring systems, such as meter circuits, service entrance equipment, and appliances per NEC requirements.

Features:

GCR grounding receptacles have:

- Grounding stud integral with housing
- Grounding stud designed to accept standard battery clip
- Thread at bottom for attaching to 3/4" threaded grounding rod
- Cover attached to receptacle by chain to prevent loss of cover
- Corrosion resistant material

GCT grounding connector and studs have:

- Substantial clip tension for grounding
- Integral cable clamp to prevent cable from breaking free of connector or fraying at connector
- Lock washer on stud to maintain good electrical contact

GC strap:

- Is pliable, strong and corrosion resistant
- Assures a lasting bond. Prongs on strap clamp engage strap perforations, preventing slippage.

Certifications and Compliances:

- UL Standard: GC strap and clamps – 467
- CSA Standard: C22.2 No. 41

Standard Materials:

- GCR – Bronze body, cap and chain; brass grounding stud
- GCT – Bronze connector body; aluminum cable clamp; brass stud
- Strap – flexible copper
- Clamp – brass

Standard Finishes:

- Bronze, brass, aluminum parts – natural
- Flexible copper strap – tinned

GCT Grounding Connector



Cable Dia.	Cat. #
.312" to .406"	GCT8

GCT Stud*

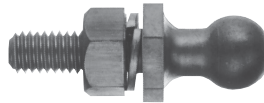

Description	Thread Size	Cat. #
Brass	3/8 - 16	GCT2

*Not a replacement for grounding stud in GCR receptacle.

GC Grounding Strap

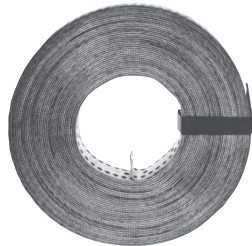

Used with GC102 Strap Clamp

Description	Cat. #
50' coil, 1" wide	GC100

GCR Receptacles For Static Electricity Grounding



Description	Thread Size	Cat. #
With cap and chain	5/16 - 18	GCR210

Strap Clamp

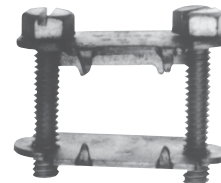

Description	Cat. #
Brass	GC102

Dimensions In Inches:

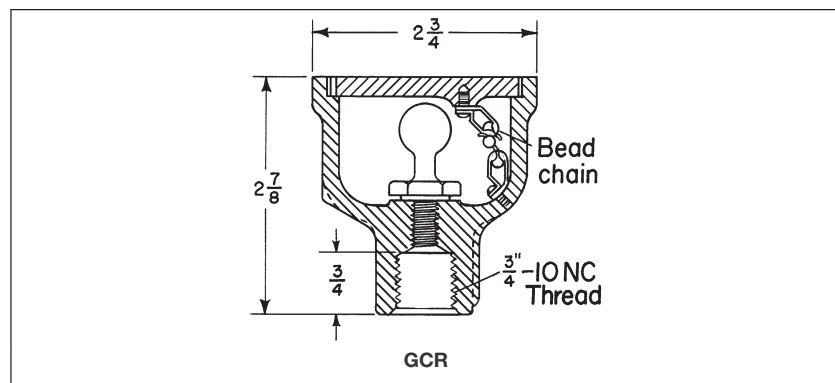

Service Entrance Heads and Replacement Covers

5F

5F

Applications:

- F type service entrance heads are used:
- For overhead service entrance to buildings
 - With threaded rigid, threadless rigid or threadless thinwall (EMT) conduit and rigid conduit masts

Features:

- Two types available:
- Threaded rigid – threads to conduit.
 - Threadless rigid or EMT – clamps to conduit.
 - Available knockouts in covers allow use with variety of sizes and numbers of wires.
 - Simple construction and easy assembly.
 - Consists of only two pieces plus the insulating knockout cover.
 - Easy to install.

Certifications and Compliances:

- UL Standard: 514B
- CSA Standard: C22.2 No. 18

Standard Materials:

- Copper-free aluminum

Standard Finishes:

- Natural

F Service Heads Threaded Rigid



1/2" size



3/4" - 2" size



1/2" size

Conduit Size	Number and Dia. of Cover Knockouts	Cat. #	Replacement Cover Cat. #
1/2	6 - 9/32	F186	CF690
3/4	2 - 3/8 and 3 - 13/32	F285	5 H
1	2 - 7/16 and 3 - 1/2	F385	5 NS
1 1/4	2 - 27/64 and 3 - 5/8	F485	5 NL
1 1/2	2 - 27/64 and 3 - 5/8	F585	5 NL
2	2 - 7/8, 1 - 13/16, 1 - 11/16, 1 - 9/16 and 1 - 21/32	F686	CF60
2 1/2	2 - 17/16, 1 - 17/32, 1 - 1 1/64, 1 - 61/64 and 1 - 55/64	F766	CF707
3	2 - 1 1/16, 1 - 1 1/32, 1 - 1 1/64, 1 - 61/64 and 1 - 55/64	F866	CF707
3 1/2	3 - 1 3/4, 1 - 1 7/16, 1 - 1 5/16 and 1 - 1 3/16	F966	CF708
4	3 - 1 3/4, 1 - 1 7/16, 1 - 1 5/16 and 1 - 1 3/16	F1066	CF708

Overall Dimensions of Replacement Covers for F Series Service Heads

Cat. #	Dim.
CF690	1 1/2 dia.
5 H	1 31/32 dia.
5 NS	2 15/64 dia.
5 NL	2 19/32 dia.
CF60	3 3/16 dia.
CF707	7 13/16 x 3 11/16
CF708	10 1/4 x 4 3/4

Clamp Type Threadless Rigid or EMT



Conduit Size	Number and Dia. of Cover Knockouts	Cat. #	Replacement Cover Cat. #
3/4	2 - 3/8 and 3 - 13/32	F235	5 H
1	2 - 7/16 and 3 - 1/2	F335	5 NS
1 1/4	2 - 27/64 and 3 - 5/8	F435	5 NL
1 1/2	2 - 27/64 and 3 - 5/8	F535	5 NL
2	2 - 7/8, 1 - 13/16, 1 - 11/16, 1 - 9/16 and 1 - 21/32	F636	CF60

5F LNR Conduit Liner

5F

Applications:

- LNR conduit liners are installed in rigid metal conduit or IMC:
- To provide a smooth wire entry from conduit into enclosures to protect wires from abrasion as they are pulled.
 - With thin wall or thick wall enclosures.
 - Entering drilled and tapped openings or slip holes.
 - Entering an enclosure vertically or horizontally.
 - Regardless of where the conduit ends in relation to the enclosure wall.

Features:

- UL listed and CSA certified.
- No need for threaded bushings, reducers, or special machining.
- Corrosion and heat resistant polypropylene material.
- Smooth flange providing easy wire pulling and protects conductors being installed.
- Space saving.
- Molded ribs ensure a tight fit, preventing the liner from sliding out while conductors are being pulled.
- Quick and easy to install.

Certifications and Compliances:

- NEC Article 346-8
- UL Standard 514B
- CSA Standard C22.2 No. 18
- U.S. Patent No. 5,383,688

Standard Materials:

- Polypropylene

Standard Finishes:

- Natural (clear)

Sizes:

- 1/2" through 4"

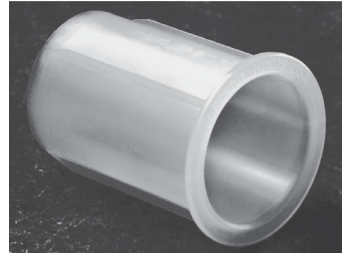

Ordering Information

Cat. #	Size	A	B	C	D
LNR1	1/2"	1 3/16"	7/8"	5/8"	9/16"
LNR2	3/4"	1 9/16"	1 1/8"	13/16"	3/4"
LNR3	1"	2 1/16"	1 3/8"	1 1/16"	7/8"
LNR4	1 1/4"	2 7/16"	1 3/4"	1 3/8"	1 1/4"
LNR5	1 1/2"	2 9/16"	2"	1 5/8"	1 7/16"
LNR6	2"	2 9/16"	2 7/16"	2 1/16"	1 7/8"
LNR7	2 1/2"	2 7/8"	2 7/16"	2 1/4"	
LNR8	3"	2 7/8"	3 9/16"	3 1/16"	2 7/8"
LNR9	3 1/2"	3 1/16"	4 1/16"	3 9/16"	3 3/8"
LNR10	4"	3 1/16"	4 9/16"	4"	3 7/8"

Dimensions In Inches:

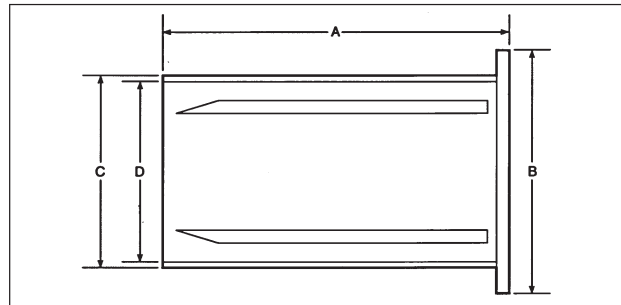



Description	Page No.
Application/Selection	see page 138
Breathers & Drains	
Standard	
ECD Series	see page 158
CD Series (Non-hazardous)	see page 159
Universal	
ECD Series	see page 158
Sealing Compound	
Chico® A	see pages 155–156
Chico® SpeedSeal™	see pages 155–156
Sealing Fiber	
Chico® X	see pages 155–156
Sealing Fittings Tool Kit	
EYS Tool Kit	see page 157
Seals	
Drains	
EYD Series	see page 144
EZD Series	see page 145
EYDX Series	see page 147
Elbows	
EYS	see page 140
Horizontal/Vertical	
ES Series	see page 149
EYS Series	see page 140
EYS Series with ATEX	see page 142
EYSA Series	see page 143
EYSX Series	see page 146
Inspection	
EZD Series	see page 145
Retrofit	
EYSR Series	see page 148
Universal	
EZS Series	see page 141
EZS Series with ATEX	see page 142
Secondary Process Seals	
Ultra High Pressure Seal	see page 150
Secondary Process Seal Assembly with Rupture Sensor	see pages 151–154

6F Conduit Seals, Breathers and Drains

Application and Selection

6F

Applications:

Seals:

- Seals are installed in conduit runs to prevent the passage of gases, vapors or flames from one portion of the electrical installation to another through the conduit, limiting any explosion to the enclosure and preventing precompression or "pressure piling."
- While not a National Electrical Code requirement, many engineers consider it good practice to sectionalize long conduit runs by inserting seals not more than 50' to 100' apart, depending on the conduit size, to minimize the effects of "pressure piling."

Breathers:

- Breathers (vents), are installed in the top of enclosures to provide ventilation to minimize condensation in enclosures.

Drains:

- Drains are used in humid atmospheres or in wet locations where it is likely that water can gain entrance to the interiors of enclosures or raceways. The raceways should be inclined so that water will not collect in enclosures or on seals, but will be led to low points where it may pass out through ECD drains.
- Frequently the arrangement of raceway runs makes this method impractical if not impossible. In such instances, EZD or EYD drain seal fittings should be used. These fittings prevent harmful accumulations of water above the seal.

Considerations for Selection:

Seals:

- Select the proper sealing fitting for the hazardous vapor involved; i.e., Class I, Division 1 & 2, Groups A, B, C or D.
- Select the appropriate seal for new or retrofit installations.
- Select a sealing fitting for the proper use in respect to mounting position. This is particularly critical when the conduit runs between hazardous and non-hazardous areas. Improper positioning of a seal may permit hazardous gases or vapors to enter the system beyond the seal and permit them to escape into another portion of the hazardous area or to enter a non-hazardous area. Some seals are designed to be mounted in any position; others are restricted to vertical mounting.

The amount of *Chico*® fiber and compound required for any seal is determined by volume, hub size and mounting position of the seal.

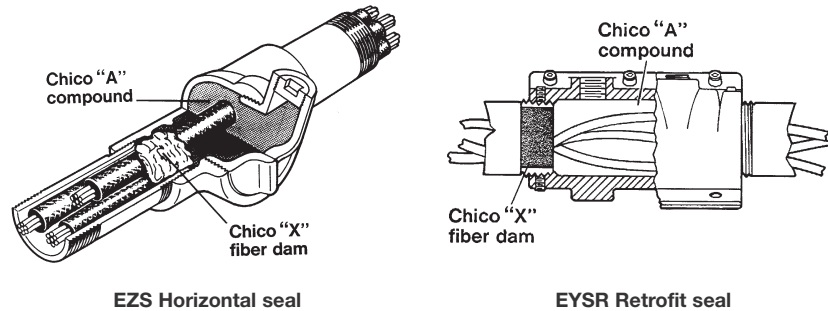

EZS Horizontal seal

EYSR Retrofit seal

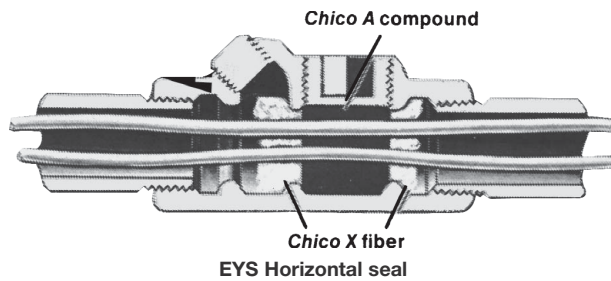

EYS Horizontal seal

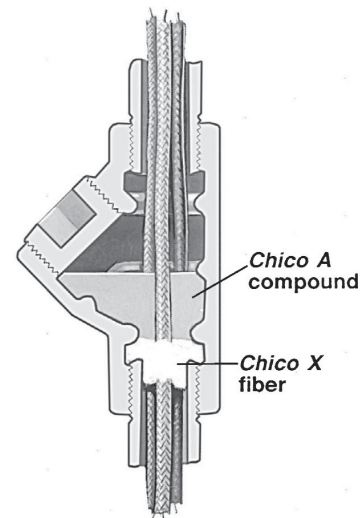

EYS 1 Vertical sealing







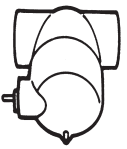
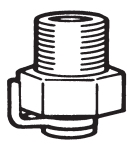

Drains:

- In locations which are usually considered dry, surprising amounts of water frequently collect in conduit systems. No conduit system is airtight, therefore, it may "breathe". Alternate increases and decreases in temperature and/or in barometric pressure, due to weather changes or due to the nature of the process carried on in the location where the conduit is installed, will cause "breathing," resulting in condensation and water accumulation.
- In view of this likelihood, it is therefore good practice to insure against such water accumulations and probable subsequent insulation failures by installing breathers, drain seals, or inspection seals, even though conditions prevailing at the time of planning or installing do not indicate their need.

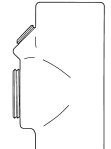
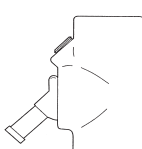
Options:

Description	Suffix
Corro-free™ epoxy powder coat	S752

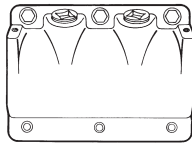
Shape Selector Chart Quick Selector Chart

Series	Page	Series	Page	Series	Page	Series	Page	Series	Page	Series	Page
EYS / EYSA	see page 140	EZD	see page 145	ECD Standard	see page 158	ECD Universal	see page 158	EYSX	see page 146	EYDX	see page 147
											
EYS Elbow Seal	see page 140	ES	see page 149			EYD	see page 144	EYSR	see page 144	EZS	see page 141
											

Quick Selector Chart

Series	Description	NEC Hazardous Group	For Conduit Angle
EYS	Seal	Class I, Groups A, B, C, D Class II, Groups E, F, G	Vertical and Horizontal
EYS ATEX	Seal	Ex II 2 G EEx d IIC	Vertical and Horizontal
EYSA	Seal	Flameproof, Exd, IIC	Vertical and Horizontal
EYS 29	Elbow Seal	Class I, Groups C, D Class II, Groups E, F, G	90° turn
EYSR	Retrofit Seal/Drain Seal*	Class I, Div. 2, Groups C, D Class II, Div. 2, Groups E, F, G Class III	Vertical and Horizontal
EYSX	Expanded Fill Sealing Fittings	Class I, Groups B, C, D Class II, Groups E, F, G	Vertical and Horizontal
EZS	Seal	Class I, Groups C, D Class II, Groups E, F, G	All
EZS ATEX	Seal	Ex II 2 G EEx d IIC	All
ES	Sealing Hub	Class I, Groups C, D	Vertical
EYD	Seal and Drain	Class I, Groups B, C, D Class II, Groups F, G	Vertical
EYDX	Expanded Fill Sealing Fittings and Drain	Class I, Groups B, C, D Class II, Groups F, G	Vertical
EZD	Inspection Seal and Drain – Inspection Seal only	Class I, Groups C, D Class II, Groups E, F, G	Vertical
ECD	Standard Breather only Drain only	Class I, Groups B, C, D Class II, Groups E, F, G Class III	
ECD	Universal Drain – Breather	Class I, Groups C, D Class II, Groups F, G	
CD	Non-hazardous Drain		
UHPS	Ultra High Pressure Seal	Class I, Div. 1, Groups B, C, D Certified to CSA Standards through QPS	
SPSR	Secondary Process Seal with Rupture Sensor	Class I, Div. 1 & 2, Groups B, C, D Class I, Zone 1 & 2 IIB + H ₂ Class II, Div. 1 & 2, Groups E, F, G	

*Drain purchased separately.



Conduit Sealing Fittings

Chico Sealing Compound and Fiber see pages 155-156

Cl. I, Div. 1 & 2, Groups A, B, C, D Explosionproof
 Cl. II, Div. 1, Groups E, F, G Dust-Ignitionproof
 Cl. II, Div. 2, Groups F, G
 Cl. III

6F

Applications:

- EYS and EZS sealing fittings:
- Restrict the passage of gases, vapors or flames from one portion of the electrical installation to another at atmospheric pressure and normal ambient temperatures
 - Limit explosions to the sealed off enclosure
 - Limit precompression or pressure "piling" in conduit systems
- Sealing fittings are required:
- At each entrance to an enclosure housing an arcing or sparking device when used in Class I, Division 1 and 2 hazardous locations. To be located as close as practicable and, in no case, more than 18" from such enclosures
 - At each conduit entrance of 2" size or larger to an enclosure or fitting housing terminals, splices or taps when used in Class I, Division 1 hazardous locations. To be located as close as practicable and, in no case, more than 18" from such enclosures
 - In conduit systems when leaving Class I, Division 1 or Division 2 hazardous locations
 - In cable systems when the cables either do not have a gas/vaportight continuous sheath or are capable of transmitting gases or vapors through the cable core when those cables leave the Class I, Division 1 or Division 2 hazardous locations

Features:

- EYS and EZS sealing fittings include:
- Minimum turning radius
 - Large openings with threaded closures to provide easy access to conduit hubs for making dams
 - Integral bushings in conduit hubs to protect conductor insulation from damage
 - Taper-tapped hubs to ensure ground continuity
- EYS sealing fittings are available for installation in either vertical only or in both horizontal or vertical positions.
- EZS sealing fittings for installation at any angle; the covers with opening for sealing compound can be properly positioned to accept the compound.

Certifications and Compliances:

- NEC/CEC:
 - EYS1-3, 11-31, 16-36, 116-316**
Class I, Division 1 & 2, Groups A, B, C, D
Class II, Division 1, Groups E, F, G
Class II, Division 2, Groups F, G
Class III
 - EYS41-101, 416-1016**
Class I, Division 1 & 2, Groups B, C, D
Class II, Division 1, Groups E, F, G
Class II, Division 2, Groups F, G
Class III
 - EYS29, 4-014, 46-0146**
EZS1-8, 16-86
Class I, Division 1 & 2, Groups C, D
Class II, Division 1, Groups F, G
Class II, Division 2, Groups F, G
Class III
- UL Standard: 1203
- CSA Standard: C22.2

Sealing fittings are approved for use in hazardous locations only when *Chico*® X fiber and *Chico A* sealing compound or Chico SpeedSeal are used to make the seal.

Standard Materials:

- Bodies – *Feraloy*® iron alloy and/or ductile iron
- Plugs – *Feraloy* iron alloy and/or steel
- Removable nipples – steel

Standard Finishes:

- Feraloy* iron alloy and ductile iron – electrogalvanized and aluminum acrylic paint
- Steel – electrogalvanized

Options:

Description
Copper-free aluminum bodies, nipples and enclosures

Suffix
SA

Size Ranges:

- 1/2" – 6"

Ordering Information - EYS

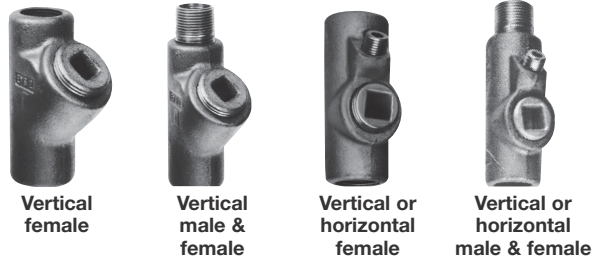

For Sealing in Vertical Positions Only

Hub Size	Female Hub Cat. #	Male & Female Hub Cat. #	Approximate Internal Volume in Cubic Inches
1/2	EYS1*	EYS16*	1
3/4	EYS2*	EYS26*	2
1	EYS3*	EYS36*	3 3/4

For Sealing in Vertical or Horizontal Positions

Hub Size	Female Hub Cat. #	Male & Female Hub Cat. #	Approximate Internal Volume in Cubic Inches	
			Vertical	Horizontal
1/2	EYS11*	EYS116*	1	1
3/4	EYS21*	EYS216*	2	2
1	EYS31*	EYS316*	3	3 3/4
1 1/4	EYS41	EYS416	6	8
1 1/2	EYS51	EYS516	10 3/4	12 1/4
2	EYS61	EYS616	19	22 3/4
2 1/2	EYS71	EYS716	25 1/2	30
3	EYS81	EYS816	56	64 1/2
3 1/2	EYS91	EYS916	72	82
4	EYS101	EYS1016	95	110

*Available in copper-free aluminum – to order, add suffix SA to Cat. No.

Dimensions (In Inches)

EYS 16 Series				EYS 116 Series		
Size	a	b	Turning Radius	a	b	Turning Radius
1/2	3 9/32	1 1/4	1 5/8	3 11/16	1 1/4	1 3/32
3/4	3 11/16	1 1/2	1 29/32	3 11/16	1 1/2	1 1/4
1	4 5/16	1 3/4	2 3/8	4 5/16	1 3/4	1 5/8

EYS 46 Series				EYS 116 Series		
Size	a	b	Turning Radius	a	b	Turning Radius
1 1/4	5 1/16	2 3/16	1 23/32	5 1/16	2 3/16	1 23/32
1 1/2	5 1/2	2 7/16	2 1/16	5 1/2	2 7/16	2 1/16
2	6 1/4	3	2 5/16	6 1/4	3	2 5/16
2 1/2	7 1/2	3 1/2	2 11/16	7 1/2	3 1/2	2 11/16
3	8 1/2	4 1/4	3 5/16	8 1/2	4 1/4	3 5/16
3 1/2	9 3/16	4 3/4	3 7/16 ‡	9 3/16	4 3/4	3 7/16 ‡
4	9 3/4	5 1/4	3 11/16 ‡	9 3/4	5 1/4	3 11/16 ‡
5	11 1/16	6 1/2	4 19/32 ‡			
6	12 1/8	7 5/8	5 11/32 ‡			

‡With cover removed.

Crouse-Hinds
by **E.T.N**

Conduit Sealing Fittings

Chico Sealing Compound and Fiber see pages 155-156

Cl. I, Div. 1 & 2, Groups C, D
Cl. II, Div. 1, Groups E, F, G
Cl. II, Div. 2, Groups F, G
Cl. III

Explosionproof
Dust-Ignitionproof

6F

Ordering Information - EYS

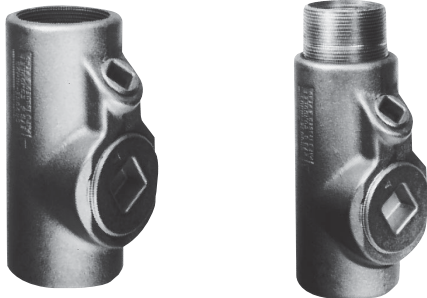

Vertical or horizontal male & female

Ordering Information - EZS

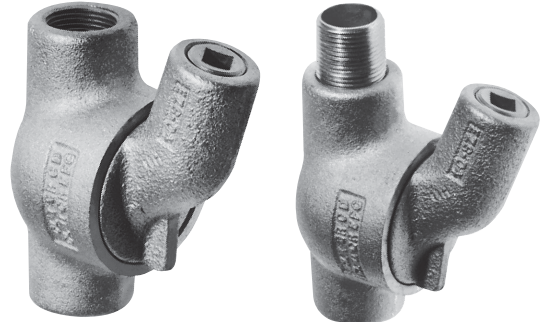

Male & female hub

For Sealing in Vertical or Horizontal Positions

Hub Size	Female Hub Cat. #	Male & Female Hub Cat. #	Approximate Internal Volume in Cubic Inches	
			Vert.	Horiz.
1¼	EYS4*	EYS46*	6	8
1½	EYS5*	EYS56*	10¾	12¼
2	EYS6*	EYS66*	19	22¾
2½	EYS7*	EYS76*	25½	30
3	EYS8*	EYS86*	56	64½
3½	EYS9*	EYS96*	72	82
4	EYS10*	EYS106*	95	110
5	EYS012	EYS0126	200	222
6	EYS014	EYS0146	290	315

*Available in copper-free aluminum – to order, add suffix SA to Cat. No.

For Sealing at Any Angle

Hub Size	Female Hub Cat. #	Male & Female Hub Cat. #	Approximate Internal Volume in Cubic Inches	
			Vert.	Horiz.
½	EZS1	EZS16	6¼	6¼
¾	EZS2	EZS26	6½	6½
1	EZS3	EZS36	10¼	10¼
1¼	EZS4	EZS46	12½	12½
1½	EZS5	EZS56	14½	14½
2	EZS6	EZS66	46	46
2½	EZS7	EZS76	55	55
3	EZS8	EZS86	90	90

EYS



Elbow seal

For Sealing in Vertical Positions

Hub Size	Cat. #	Approximate Internal Volume in Cubic Inches
¾	EYS29	1¾

Dimensions In Inches

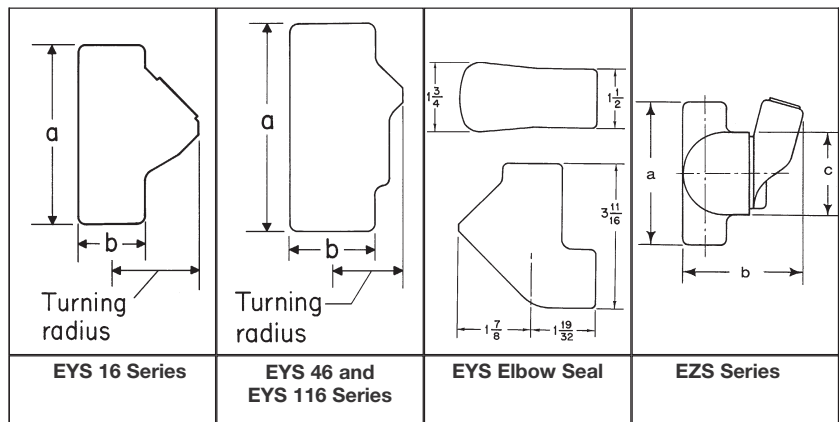

EYS Elbow Seal

Size	a	b	Turning Radius (Vertical)
¾	3 ¹¹ / ₁₆	1¾	1 ⁷ / ₈

EZS Series

Size	a	b	c	Turning Radius†
½	4 ⁹ / ₁₆	3 ⁵ / ₈	2½	1 ⁷ / ₈
¾	4 ³ / ₁₆	3 ⁵ / ₈	2½	1 ⁷ / ₈
1	4 ¹⁵ / ₁₆	3 ³¹ / ₃₂	3	2 ¹ / ₈
1¼	5 ¹ / ₁₆	4 ¹³ / ₃₂	3	2 ⁹ / ₁₆
1½	5 ³ / ₁₆	4 ⁹ / ₁₆	3¼	2 ¹¹ / ₃₂
2	7 ¹ / ₁₆	5 ¹³ / ₃₂	5 ¹ / ₁₆	3 ⁹ / ₃₂
2½	7 ¹⁵ / ₁₆	5 ²⁷ / ₃₂	5 ⁹ / ₁₆	3 ³ / ₈
3	8 ⁵ / ₈	6½	5 ⁷ / ₈	3 ⁷ / ₈

†With cover removed.

for IEC Applications

6F

Applications:

EYS and EZS sealing fittings:

- Restrict the passage of gases, vapors or flames from one portion of the electrical installation to another at atmospheric pressure and normal ambient temperatures
- Limit explosions to the sealed off enclosure
- Limit precompression or pressure "piling" in conduit systems

Sealing fittings are required:

- At each entrance to an enclosure housing an arcing or sparking device when used in Class I, Division 1 and 2 hazardous locations. To be located as close as practicable and, in no case, more than 18" from such enclosures
- At each conduit entrance of 2" size or larger to an enclosure or fitting housing terminals, splices or taps when used in Class I, Division 1 hazardous locations. To be located as close as practicable and, in no case, more than 18" from such enclosures
- In conduit systems when leaving Class I, Division 1 or Division 2 hazardous locations
- In cable systems when the cables either do not have a gas/vaportight continuous sheath or are capable of transmitting gases or vapors through the cable core when those cables leave the Class I, Division 1 or Division 2 hazardous locations

Features:

EYS and EZS sealing fittings include:

- Minimum turning radius
- Large openings with threaded closures to provide easy access to conduit hubs for making dams
- Integral bushings in conduit hubs to protect conductor insulation from damage
- Taper-tapped hubs to ensure ground continuity

EYS sealing fittings are available for installation in either vertical only or in both horizontal or vertical positions.

EZS sealing fittings for installation at any angle; the covers with opening for sealing compound can be properly positioned to accept the compound.

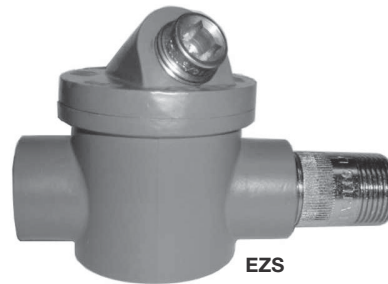

EZS



EYS

Certifications and Compliances:

- IEC:
 - Ex II 2 G EEx d IIC
 - EC-Type examination certificate LOM 03 ATEX 2108
- IP67 according to EN 60529

Standard Materials:

- Bodies – Light alloy, natural finish
- Plugs – Light alloy, natural finish
- Removable nipples – Light alloy, natural finish

Size Ranges:

- EYS - 1/2" – 4"
- EZS - 1/2" – 1"

Ordering Information:

Series	Mounting Direction	Hub Size	Cat. #
EYS	Vertical	1/2" NPT	NOR 000 002 220 117
EYS	Vertical	3/4" NPT	NOR 000 002 220 125
EYS	Vertical	1" ISO	NOR 000 002 220 133
EYS	Vertical	1" NPT	NOR 000 002 220 620
EYS	Horizontal	1 1/2" NPT	NOR 000 002 220 160
EYS	Horizontal	2" NPT	NOR 000 002 220 168
EZS	Horizontal	1/2" NPT	NOR 000 002 220 216
EZS	Horizontal	3/4" NPT	NOR 000 002 220 224
EZS	Horizontal	1" ISO	NOR 000 002 220 232
EZS	Horizontal	1" NPT	NOR 000 002 220 729

EYSA Flameproof Sealing Fitting



Applications:

EYSA sealing fittings:

- Restrict the passage of gases, vapors, or flames from one portion of the electrical installation to another at atmospheric pressure and normal ambient temperatures
- Limit explosions to the sealed off enclosure
- Prevent pre-compression or "pressure piling" in conduit systems

Sealing fittings are required:

- At each entrance to an enclosure housing an arcing or sparking device when used in Zone 1, hazardous locations to be located as close as practicable and in no case more than 450mm from such enclosures
- In conduit systems when leaving the Zone 1 area and entering an area of lesser hazard

Features:

- Minimum turning radius
- Large openings with threaded closures to provide easy access to conduit hubs for making dams
- Integral bushings to protect conductor insulation from damage
- Removable male nipple supplied when male and female hub style is ordered

Certifications and Compliances:

- Type of Protection: Ex d, DIP A21, T60°C, IP66
- Degree of Protection: IP66
- Gas Group: IIC
- Approvals: IEC Ex TSA07.0015-1

Standard Materials:

- Bodies - copper-free aluminum
- Removable nipples and plugs - brass

Standard Finishes:

- Body - polyurethane gray
- Nipples and plugs - natural

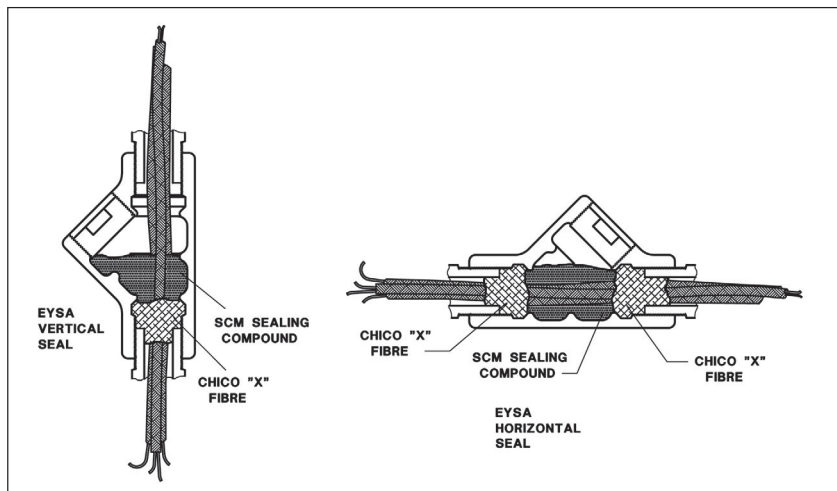
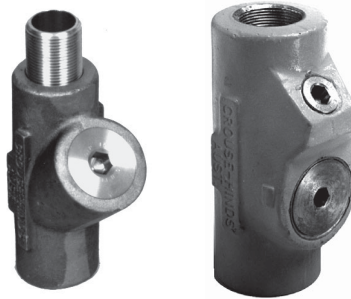

Ordering Information:

Entry Size	Female	Male & Female	Weight of Sealing Compound per Seal (g)	Weight of Chico X Fiber per Seal (g)
20mm/20mm	EYSA1M	EYSA16M	50	1
25mm/25mm	EYSA2M	EYSA26M	100	2
32mm/32mm	EYSA3M	EYSA36M	188	3.5
40mm/40mm	EYSA4M	EYSA46M	406	7
50mm/50mm	EYSA5M	EYSA56M	550	14
¾" BSP/¾" BSP	EYSA2B	EYSA26B	100	2
20mm/1½" BSP	EYSA11MB	-	50	1
20mm/¾" BSP	EYSA12MB	-	50	1
25mm/1½" BSP	EYSA21MB	-	100	2
25mm/¾" BSP	EYSA22MB	-	100	2

6F Conduit Sealing Fittings With Drains

Cl. I, Div. 1 & 2, Groups B, C, D§ Explosionproof
 Cl. II, Div. 1, Groups E, F, G Dust-Ignitionproof
 Cl. II, Div. 2, Groups F, G
 Cl. III

6F

Applications:

- EYD drain and EZD drain and inspection sealing fittings:
- Restrict the passage of gases, vapors or flames from one portion of the electrical installation to another at atmospheric pressure and normal ambient temperatures
 - Limit explosions to the sealed-off enclosure
 - Prevent precompression or "pressure piling" in conduit systems

Drain sealing fittings are installed in vertical conduit runs and at low points in conduit systems to prevent accumulation of condensate above seal.

For sealing fittings requirements see page 139.

Features:

- EYD and EZD drain sealing fittings include:
- Drain to provide continuous, automatic drainage of condensate
 - Large openings with threaded closures to provide easy access to conduit hubs for making dams
 - Integral bushings to protect conductor insulation from damage
 - Taper-tapped hubs to ensure ground continuity
- EZD drain and inspection sealing fittings also include:
- Removable covers for periodic inspection of seals
 - Barrier for sealing compound easily installed after dams are made and before compound is poured.

Certifications and Compliances:

- NEC/CEC:
 - EYD11-101, 116-1016**
 Class I, Division 1 & 2, Groups B, C, D
 Class II, Division 1, Groups E, F, G
 Class II, Division 2, Groups F, G
 Class III
 - EYD1-10, 16-106, EZD10-60, 111-611**
 Class I, Division 1 & 2, Groups C, D
 Class II, Division 1, Groups F, G
 Class II, Division 2, Groups F, G
 Class III
- UL Standard: 1203
- CSA Standard: C22.2

Standard Materials:

- Bodies, and inspection or drain covers – *Feraloy*® iron alloy and/or ductile iron
- Closure for drain – copper-free aluminum or ductile iron
- Small closure plug – *Feraloy* iron alloy and/or steel
- Drain – stainless steel
- Removable nipples – steel

Standard Finishes:

- Feraloy* iron alloy and ductile iron – electrogalvanized and aluminum acrylic paint
- Copper-free aluminum – natural
- Stainless steel – natural
- Steel – electrogalvanized

Options:

Description
 Copper-free aluminum bodies, nipples and enclosures

Suffix
 SA

Size Ranges:

- EYD – ½" – 4"
- EZD – ½" – 2"

Ordering Information - EYD



½" – 1"
 Female hub



½" – 1"
 Male & female hub



1¼" – 4"
 Female hub



1¼" – 4"
 Male & female hub

Hub Size	Female Hub Cat. #	Male & Female Hub Cat. #	Female Hub Cat. #	Male & Female Hub Cat. #	Approximate Internal Volume in Cubic Inches
½	EYD1*	EYD16*	EYD11	EYD116	1
¾	EYD2*	EYD26*	EYD21	EYD216	2
1	EYD3*	EYD36*	EYD31	EYD316	3¾
1¼	EYD4*	EYD46*	EYD41	EYD416	8
1½	EYD5*	EYD56*	EYD51	EYD516	10¾
2	EYD6*	EYD66*	EYD61	EYD616	20
2½	EYD7*	EYD76*	EYD71	EYD716	35
3	EYD8*	EYD86*	EYD81	EYD816	57
3½	EYD9*	EYD96*	EYD91	EYD916	75
4	EYD10*	EYD106*	EYD101	EYD1016	105

Dimensions In Inches

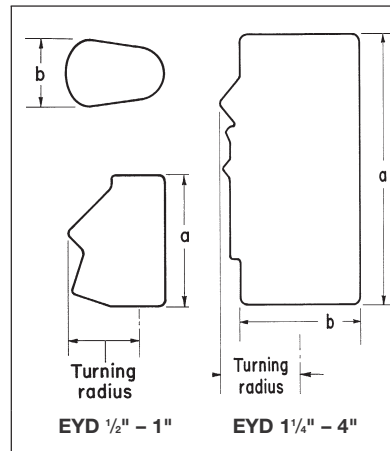

EYD Drain Seal

Size	a	b	Turning Radius
½	3 ³ / ₃₂	1¼	1 ⁵ / ₈
¾	3 ¹¹ / ₁₆	1½	1 ²⁹ / ₃₂
1	4 ³ / ₁₆	2 ³ / ₁₆	2 ³ / ₈
1¼	5 ¹ / ₁₆	2 ³ / ₁₆	1-27 ¹ / ₃₂ †
1½	5½	2 ⁷ / ₁₆	2-1 ¹ / ₁₆ †
2	6¼	3	2-5 ¹ / ₁₆ †
2½	7½	3½	2-11 ¹ / ₁₆ †
3	8½	4¼	3-5 ¹ / ₁₆ †
3½	9 ³ / ₁₆	4¾	3-7 ¹ / ₁₆ †
4	9¾	5¼	3-1½†

†With cover removed.
 *Available in copper-free aluminum – to order, add suffix SA to Cat. No.
 Sealing Fittings are approved for use in hazardous locations only when *Chico*® X fiber and *Chico A* sealing compound or *Chico SpeedSeal* are used to make the seal.
 §See Certifications and Compliances for classification of each product.

Conduit Sealing Fittings with Drain and Inspection Cover

Cl. I, Div. 1 & 2, Groups C, D Explosionproof
 Cl. II, Div. 1, Groups E, F, G Dust-Ignitionproof
 Cl. II, Div. 2, Groups F, G
 Cl. III

6F

Chico Sealing Compound and Fiber
 see pages 155–156

EZD With Drain Cover

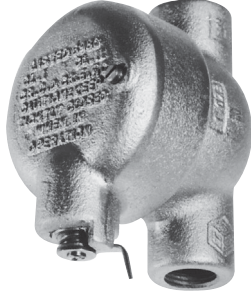

Hub Size	Cat. #	Approximate Internal Volume in Cubic Inches
1/2	EZD111	5
3/4	EZD211	6
1	EZD311	10
1 1/4	EZD411	11
1 1/2	EZD511	13
2	EZD611	40

Dimensions In Inches:

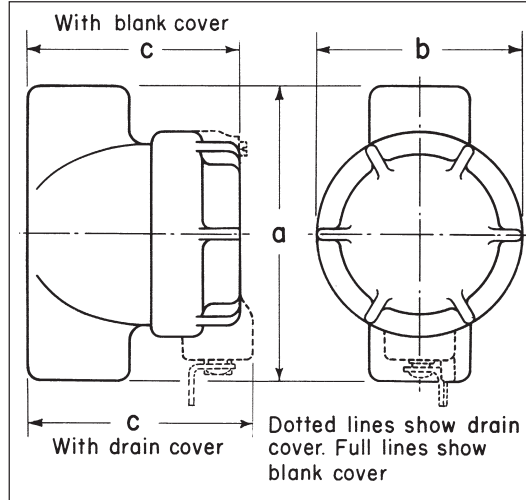

EZD Drain and Inspection Seals

Size	a	b	Drain Cover c	Turning Radius†
1/2	4 ³ / ₁₆	3	3 ³ / ₈	2 ¹ / ₁₆
3/4	4 ³ / ₁₆	3	3 ⁵ / ₈	2 ³ / ₁₆
1	4 ¹⁵ / ₁₆	3 ¹ / ₂	3 ⁷ / ₈	2 ⁷ / ₁₆
1 1/4	4 ¹⁵ / ₁₆	3 ¹ / ₂	4 ⁵ / ₁₆	2 ⁵ / ₈
1 1/2	5 ³ / ₁₆	3 ¹ / ₂	4 ⁹ / ₁₆	2 ¹¹ / ₁₆
2	7 ¹ / ₈	5 ¹ / ₁₆	5 ¹ / ₄	3 ¹¹ / ₁₆

†With cover removed.

6F

EYSX Expanded Fill Sealing Fittings

Chico Sealing Compound and Fiber see pages 155-156

Cl. I, Div. 1 & 2, Groups B, C, D§
 Cl. II, Div. 1, Groups E, F, G
 Cl. II, Div. 2, Groups F, G
 Cl. III

Explosionproof
 Dust-Ignitionproof

6F

Applications:

EYSX Expanded Fill Sealing Fittings:

- Restrict the passage of gases, vapors or flames from one portion of the electrical installation to another at atmospheric pressure and normal ambient temperatures
- Limit explosions to the sealed-off enclosure
- Limit precompression or "pressure piling" in conduit systems
- Provide 40% wire fill capacity to allow uninterrupted runs in a conduit system

Sealing fittings are required:

- At each entrance to an enclosure housing an arcing or sparking device when used in Class I, Division 1 and 2 hazardous locations. To be located as close as practicable and, in no case, more than 18" from such enclosures
- At each entrance of 2" size or larger to an enclosure or fitting housing terminals, splices or taps when used in Class I, Division 1 hazardous locations. To be located as close as practicable and, in no case, more than 18" from such enclosures
- In conduit systems when leaving Class I, Division 1 or 2 hazardous locations
- In cable systems when the cables either do not have a gas/vaportight continuous sheath or are capable of transmitting gases or vapors through the cable core when those cables leave the Class I, Division 1 or 2 hazardous locations

Features:

EYSX Expanded Fill Sealing Fittings provide:

- A 40% wire fill capacity for expanded fill sealing
- Large openings with threaded closures to provide easy access to conduit hubs for making dams
- Integral bushings in conduit hubs to protect conductor insulation from damage
- Taper-tapped hubs to ensure ground continuity
- Minimum turning radius

EYSX Expanded Fill Sealing Fittings are available for installation in both horizontal or vertical positions.

Certifications and Complies:

• NEC/CEC:

EYSX11 – EYSX81

Class I, Division 1 and 2, Groups B, C, D
 Class II, Division 1, Groups E, F, G
 Class II, Division 2, Groups F, G
 Class III

EYSX9, EYSX10, EYSX1 SA – EYSX10 SA

Class I, Division 1 and 2, Groups C, D
 Class II, Division 1, Groups E, F, G
 Class II, Division 2, Groups F, G
 Class III

- UL Standard: 1203
- CSA Standard: C22.2 No. 30

Standard Materials:

- Bodies – *Feraloy*® iron alloy and/or ductile iron or copper-free aluminum (SA Suffix)
- Closures – *Feraloy* iron alloy and/or steel or copper-free aluminum (SA Suffix)

Standard Finishes:

- Feraloy* iron alloy and ductile iron – electrogalvanized and aluminum acrylic paint
- Steel – electrogalvanized
- Copper-free aluminum – natural

Options:

Description
 Copper-free aluminum bodies and enclosures

Suffix

SA

Size Ranges:

- 1/2" – 4"

Ordering Information For Sealing in Vertical or Horizontal Positions

Hub Size	Female Cat. #	Internal Volume in Cubic Inches	
		Vertical	Horizontal
1/2	EYSX11*	2	2
1/2	EYSX1 SA	2	2
3/4	EYSX21*	3	3 3/4
3/4	EYSX2 SA	3	3 3/4
1	EYSX31	6	8
1	EYSX3 SA	6	8
1 1/4	EYSX41	19	22 3/4
1 1/4	EYSX4 SA	19	22 3/4
1 1/2	EYSX51	19	22 3/4
1 1/2	EYSX5 SA	19	22 3/4
2	EYSX61	56	64 1/2
2	EYSX6 SA	56	64 1/2
2 1/2	EYSX71	72	82
2 1/2	EYSX7 SA	72	82
3	EYSX81	95	110
3	EYSX8 SA	95	110
3 1/2	EYSX9*	200	222
3 1/2	EYSX9 SA	200	222
4	EYSX10*	200	222
4	EYSX10 SA	200	222



Vertical or horizontal female

Sealing fittings are approved for use in hazardous locations only when *Chico*® X fiber and *Chico A* sealing compound or *Chico SpeedSeal* are used to make the seal.

Dimensions

In Inches:

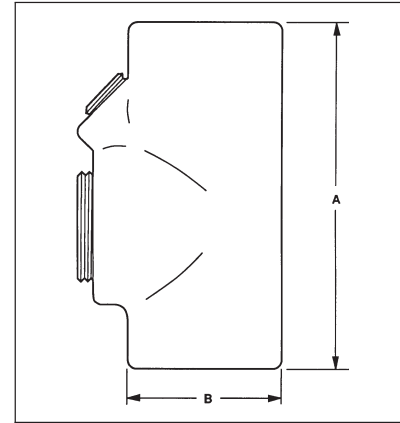

NPT Size	A	B	Turning Radius
1/2	3 11/16	1 1/2	1 1/4
3/4	4 5/16	1 3/4	1 3/8
1	5 1/16	2 3/16	1 23/32
1 1/4	6 7/4	3	2 5/16
1 1/2	6 1/4	3	2 5/16
2	8 1/2	4 1/4	3 5/16
2 1/2	9 7/16	4 3/4	3 - 7/16 ‡
3	9 3/4	5 1/4	3 - 11/16 ‡
3 1/2	11 1/16	6 1/2	4 - 19/32 ‡
4	11 7/16	6 1/2	4 - 19/32 ‡

§ See Certifications and Complies for classification of each product.

‡With plug cover removed.

*Feraloy®

EYDX Expanded Fill Sealing Fittings With Drains

Chico Sealing Compound and Fiber
see pages 155–156

Cl. I, Div. 1 & 2, Groups B, C, D§
Cl. II, Div. 1, Groups E, F, G
Cl. II, Div. 2, Groups F, G
Cl. III

Explosionproof
Dust-Ignitionproof

6F

Applications:

EYDX Expanded Fill Sealing Fittings with drains:

- Restrict the passage of gases, vapors or flames from one portion of the electrical installation to another at atmospheric pressure and normal ambient temperatures
- Limit explosions to the sealed-off enclosure
- Prevent precompression or "pressure piling" in conduit systems
- Provide 40% wire fill capacity to allow uninterrupted runs in a conduit system

Drain sealing fittings are installed in vertical conduit runs and at low points in conduit systems to prevent accumulation of condensate above seal.

For sealing fittings requirements see page 139.

Features:

EYDX Expanded Fill drain sealing fittings provide:

- A 40% wire fill capacity for expanded fill sealing
- Drain to provide continuous, automatic drainage of condensate
- Large openings with threaded closures to provide easy access to conduit hubs for making dams
- Integral bushings to protect conductor insulation from damage
- Taper-tapped hubs to ensure ground continuity

Certifications and Compliances:

- NEC/CEC:
 - EYDX11 – EYDX81**
Class I, Division 1 and 2, Groups B, C, D
Class II, Division 1, Groups E, F, G
Class II, Division 2, Groups F, G
Class III
 - EYDX1 SA – EYDX8 SA**
Class I, Division 1 and 2, Groups C, D
Class II, Division 1, Groups F, G
Class II, Division 2, Groups F, G
Class III
- UL Standard: 1203
- CSA Standard: C22.2 No. 30

Standard Materials:

- Bodies and drain covers – *Feraloy*® iron alloy, and ductile iron or copper-free aluminum (SA Suffix)
- Closure for drain – copper-free aluminum or malleable iron
- Small closure plug – *Feraloy* iron alloy and/or steel or copper-free aluminum (SA Suffix)
- Drain – stainless steel

Standard Finishes:

- *Feraloy* iron alloy and ductile iron – electrogalvanized and aluminum acrylic paint
- Copper-free aluminum – natural
- Stainless steel – natural
- Steel – electrogalvanized

Options:

Description
Copper-free aluminum bodies and enclosures

Suffix
SA

Size Ranges:

- EYDX – ½" – 3"

Sealing Fittings are approved for use in hazardous locations only when *Chico*® X fiber and *Chico A* sealing compound or *Chico SpeedSeal* are used to make the seal.

Ordering Information

Hub Size	Female Hub Cat #	Internal Volume in Cubic Inches
½	EYDX11*	2
½	EYDX1 SA	2
¾	EYDX21*	3¾
¾	EYDX2 SA	3¾
1	EYDX31	8
1	EYDX3 SA	8
1¼	EYDX41	20
1¼	EYDX4 SA	20
1½	EYDX51	20
1½	EYDX5 SA	20
2	EYDX61	57
2	EYDX6 SA	57
2½	EYDX71	75
2½	EYDX7 SA	75
3	EYDX81	105
3	EYDX8 SA	105

§ See Certifications and Compliances for classification of each product.
* *Feraloy*®

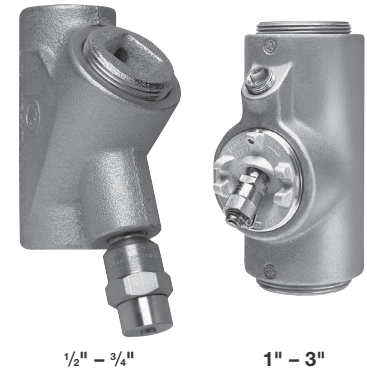

Dimensions In Inches:

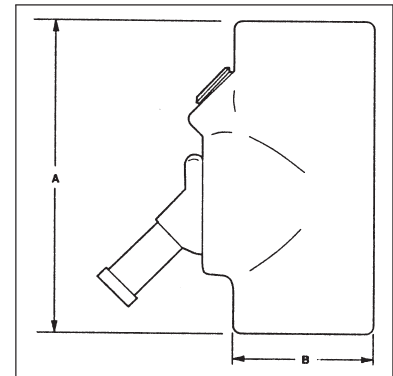

EYDX NPT

Size	A	B	Turning Radius
½	3 ¹¹ / ₁₆	1 ³ / ₄	1 ²⁹ / ₃₂
¾	4 ⁵ / ₁₆	2 ³ / ₁₆	2 ³ / ₁₆
1	5 ¹ / ₁₆	2 ³ / ₁₆	1 ⁻²⁷ / ₃₂ †
1¼	6 ¹ / ₄	3	2 ⁻⁵ / ₁₆ †
1½	6 ¹ / ₄	3	2 ⁻⁵ / ₁₆ †
2	8 ¹ / ₂	4 ¹ / ₄	3 ⁻⁵ / ₁₆ †
2½	9 ³ / ₁₆	4 ³ / ₄	3 ⁻⁷ / ₁₆ †
3	9 ³ / ₄	5 ¹ / ₄	3 ⁻¹ / ₂ †

†With drain cover removed.

Crouse-Hinds

by **E.T.N**

EYSR Retrofit Sealing Fitting

Chico Sealing Compound and Fiber see pages 155–156

Cl. I, Div. 2, Groups C, D
 Cl. II, Div. 2, Groups E, F, G
 Explosionproof
 Dust-Ignitionproof

6F

Applications:

- EYSR retrofit sealing fittings are installed:
- In rigid metal conduit systems in Class I, Division 2 hazardous locations
 - To replace installed Eaton's Crouse-Hinds type EYS or EYD sealing fittings
 - Without disassembly of the conduit system
 - In vertical or horizontal positions, indoors or outdoors
 - To restrict the passage of gases, vapors, or flames from one portion of the electrical system to another at atmospheric pressures and normal ambient temperatures
 - To limit explosions to the sealed-off enclosure
 - To limit precompression or "pressure piling" in the conduit system
 - To prevent accumulation of water in the conduit system when installed with an ECD15 drain

Features:

- Seal may be installed in the existing conduit run without disassembly of the conduit system saving time and labor
- Overall length and spacing requirements do not exceed those of standard EYS seals; permits close nesting of seals
- Pipe plugs permit the installation of a standard ECD15 drain fitting (order separately) for use in vertical conduit runs to drain any water that might accumulate in the conduit system
- Steel set screws provide grounding continuity
- Suitable for vertical and horizontal installations for indoor and outdoor applications
- Available in 3/4" to 4" NPT sizes

Certifications and Compliances:

- NEC:
 - Class I, Division 2, Groups C, D
 - Class II, Division 2, Groups E, F, G
- UL Standard: 1203
- CEC:
 - Class I, Division 1, Groups C, D
 - Class II, Division 1, Groups E, F, G
- CSA Standard: C22.2 No. 30

EYSR sealing fittings are approved for use in hazardous locations only when *Chico*® A sealing compound and *Chico X* fiber are used to make the seal.

Standard Materials:

- Body – *Feraloy*® iron alloy
- Pipe plugs, bolts and set screws – steel
- Gasket – neoprene

Standard Finishes:

- *Feraloy* iron alloy – electrogalvanized and aluminum acrylic paint
- Steel – electrogalvanized
- Gasket – natural

Options:

Description
 Copper-free aluminum

Suffix
 SA

Size Ranges:

- 3/4" – 4"

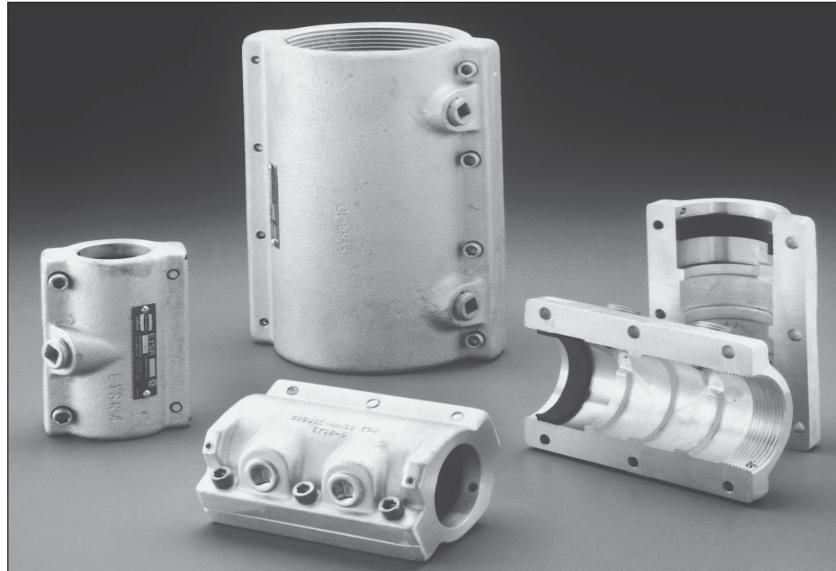

Ordering Information

Hub Size	Cat. #	Approximate Internal Volume in Cubic Inches*		Approximate Amount (oz.) of Fiber per Hub	
		Vert.	Horiz.	Vert.	Horiz.
3/4	EYSR2	3 1/2	5 3/4	1/16	1/8
1	EYSR3	4 3/4	9 1/2	1/8	1/4
1 1/4	EYSR4	7	13 1/2	1/4	1/2
1 1/2	EYSR5	12 1/4	24 1/4	1/2	1
2	EYSR6	25 1/4	40 1/2	1	2
2 1/2	EYSR7	48	75 1/2	1 1/2	3
3	EYSR8	86 1/2	126	2	4
3 1/2	EYSR9	147	210	4 1/2	9
4	EYSR10	186	252	4 1/2	9

*Use the approximate internal volume in cubic inches to determine how much Chico A sealing compound is required.

Dimensions In Inches:

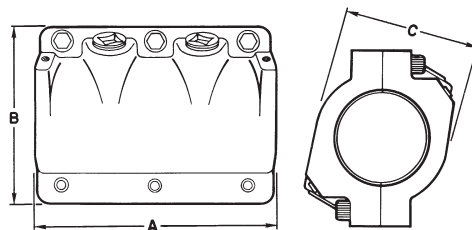

Cat. #	A	B	C	Cat. #	A	B	C
EYSR2	3 11/16	2 1/2	1 1/2	EYSR7	7 1/2	5	3 3/8
EYSR3	4 3/8	3 1/8	3 1/8	EYSR8	8 1/2	5 1/2	4 1/4
EYSR4	5	3 3/8	3	EYSR9	9 13/64	6 1/16	4 3/4
EYSR5	5 1/4	3 5/8	3	EYSR10	9 3/4	6 5/8	5 1/4
EYSR6	6 1/4	4	3				

Crouse-Hinds
 by **E.T.N**

ES Sealing Hubs

Cl. I, Div. 1 & 2, Groups C, D
Explosionproof
Watertight

6F

Chico Sealing Compound and Fiber
see pages 155–156

Applications:

ES sealing hubs are used to:

- Seal vertical conduit risers at switchgear and motor control centers, sheet metal structures or cast boxes and enclosures
- Seal horizontal conduit runs at enclosures when used with TSC sealing compound



Certifications and Compliances:

- Class I, Division 1 & 2, Groups C & D
- UL Standard: 1203
- CSA Standard: C22.2 No. 30

Standard Materials:

- *Feraloy*® iron alloy

Standard Finishes:

- Electrogalvanized and aluminum acrylic paint

Options:

ES sealing hubs, when used with SG armored gaskets and locknuts, provide a water and oiltight connection

Description

Sealing gaskets and locknuts

Suffix
SG

Ordering Information

Female Hub Size	Male Hub Size	Cat. #	Approximate Internal Volume in Cubic Inches
1/2	1	ES31	.65
3/4	1	ES32	.65
1	1 1/2	ES53	3.2
1 1/4	2	ES64	4.9
1 1/2	2	ES65	4.7
2	2 1/2	ES76	9.1
3	4	ES108	36.0
4	5	ES01210	95.0
5	6	ES014012	155.0

Note: Sealing hubs are approved for use in hazardous locations when *Chico*® X fiber and *Chico* A sealing compound are used to make the seal. Sealing hubs are approved for horizontal conduit runs for use in hazardous locations when used with TSC sealing compound, order 1 oz. tube as TSC1.

TSC Epoxy Sealing Compound



A two part epoxy sealing compound may be used to seal ES sealing hubs. It is quick and easy to measure, mix and install. The compound is kneaded until a uniform color is obtained. It is then packed around the conductors to effectively seal the cable.

Std. Ctn. Qty.	Tube Size	Cat. #†
10	0.5 oz	TSC05
10	1.0 oz	TSC1
5	4.0 oz	TSC4

†Order quantity of one (1) TSC05 or TSC1 equals 10 tubes; one (1) TSC4 equals 5 4.0 oz tubes.

Typical Installations

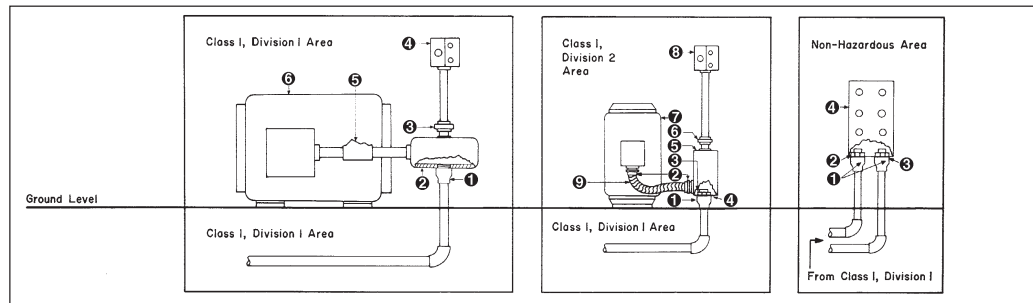

1. ES Sealing Hub
2. EJB Junction Box
3. UNY Union
4. EDS Factory Sealed Control Station
5. EYS Horizontal Seal
6. Explosion-Proof Motor

1. ES Sealing Hub
2. LT Connector
3. Locknut
4. Sealing Gasket
5. Junction Box
6. UNY Union
7. Synchronous Motor
8. EDS Factory Sealed Control Station
9. LT Conduit

1. ES Sealing Hub
2. Locknut
3. Sealing Gasket
4. Sheet Metal Structure, Motor Control Center, Panelboard, Unit Substation, Etc.

Dimensions In Inches:

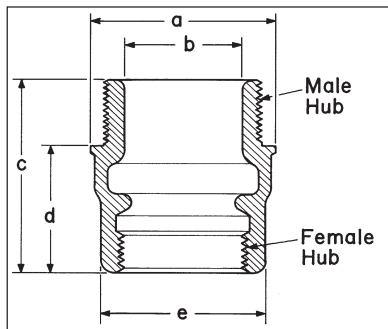

Cat. #	a	b	c	d	e
ES31	1 9/16	7/8	2	2 9/32	1 1/4
ES32	1 13/16	7/8	2	2 5/32	1 1/2
ES53	2 1/4	1 3/8	2 3/4	1 15/16	1 3/4
ES64	2 3/4	1 3/4	2 3/4	1 15/16	2 3/16
ES65	2 3/4	1 5/8	3 1/16	2	2 7/16
ES76	3 1/2	2 1/16	3 9/16	2	3
ES108	5 1/4	3 5/8	4 3/4	2 31/32	4 1/4
ES01210	6 5/8	4 5/8	6 3/4	4 27/32	5 1/4
ES014012	7 1/4	5 25/32	7 1/4	5 11/32	6 1/2

Crouse-Hinds

by E.T.N

6F Ultra High Pressure Seal

Cl. I, Div. 1, Groups B, C, D
 Certified to CSA Standards through QPS

Rated to 1500 PSI

6F

Applications:

- If the primary seal in an instrument should fail, the Eaton's Crouse-Hinds Ultra High Pressure Seal (UHPS) will prevent gases from migrating through the electrical system into a non-classified location.
- Are designed to prevent the passage of gases under pressure through conduits, cables and conductors.
- Are ideal where volatile liquids or gases are stored, processed or transported under pressure.

Certifications & Compliances:

- Class I, Division 1, Groups B, C, D
- Certified to CSA Standards through QPS
- 24 Volt DC - 120 Volt AC
- Wire grade is rated to a 600 Volt safety factor
- 1/2" MNPT x 1/2" NPT
- Conforms to Section 18-108 and 18-158 of the CEC® for The Requirements of a Secondary Seal.

Standard Materials & Finishes:

- Stainless steel body - natural finish

Quality Assurance:

Each fitting is tested at 1.5 times working pressure (max. working pressure 1500 PSI) as a gas and liquidtight explosionproof fitting. Each seal is also di-electric and resistance tested.

Ordering Information:

Catalog Number	Description
CH6DR500X002D14G	UHPS, 2 wire, 14 gauge
CH6DR500X002D16G	UHPS, 2 wire, 16 gauge
CH6DR500X002D18G	UHPS, 2 wire, 18 gauge
CH6DR500X002D22G	UHPS, 2 wire, 22 gauge
CH6DR500X004D14G	UHPS, 4 wire, 14 gauge
CH6DR500X004D16G	UHPS, 4 wire, 16 gauge
CH6DR500X004D18G	UHPS, 4 wire, 18 gauge
CH6DR500X004D22G	UHPS, 4 wire, 22 gauge
CH6DR500X234D14G	UHPS, 4 wire, 14G, 2' input, 3' output
CH6DR500X264D16G	UHPS, 4 wire, 16G, 2' input, 6' output
CH6DR500X294D16G	UHPS, 4 wire, 16G, 2' input, 9' output
CH6DR500X2D2D16G	UHPS, 2 wire, 16G, 2' input, CF output

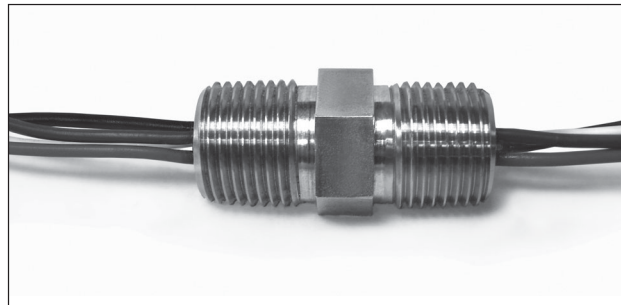
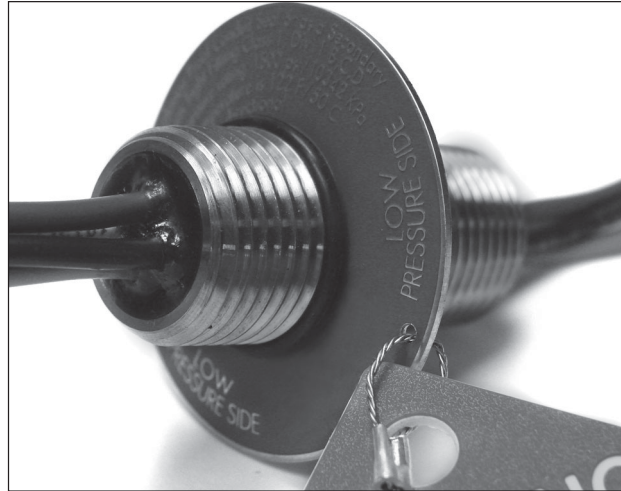

INSTALLATION EXAMPLE:

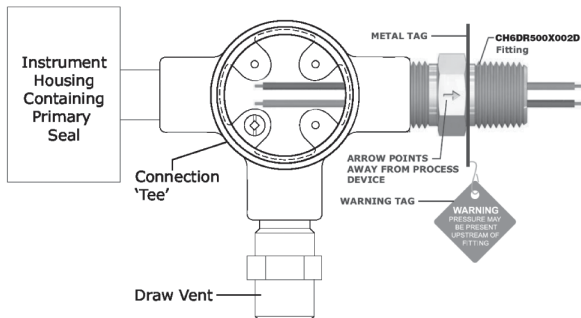

Secondary Process Seal Assemblies

Cl. I, Div. 1 & 2, Groups B, C, D NEMA 3, 4, 7BCD, 9
 Cl. I, Zone 1 & 2 IIB + H₂
 Cl. II, Div. 1 & 2, Groups E, F, G

6F



Applications:

Eaton's Crouse-Hinds Secondary Process Seal Assembly with Rupture Indication Sensor is designed to prevent the passage of gases under pressure through conduit, cables and conductors while providing immediate notification of a dangerous, potentially explosive seal rupture. These assemblies are ideal where volatile liquids or gases are stored, processed or transported under pressure. If the primary seal in an instrument should fail, the Eaton's Crouse-Hinds Secondary Process Seal will prevent gases, vapors and liquids from migrating into the non-classified location through the electrical system.

Rupture Indication Sensor:

The Secondary Process Seal features a rupture indication sensor that opens safely at 60 psi minimum and activates a circuit to a control system or alarm, which immediately alerts maintenance personnel that the primary seal has ruptured. The location of the problem can be pinpointed so the problem can be quickly addressed.

Innovative, intelligent technology combined with easy installation and low maintenance cost provides a safe and reliable solution for detection of a process seal rupture within your facility.



Features and Benefits:

Secondary Process Seal

- CSA and CSAus certified
- Meets or exceeds ANSI / ISA / CSA / CEC / NEC / API requirements for a secondary process seal and explosionproof conduit seal
- Sealed to 1500 psi, operates in any position
- Simplified design allows for easier installation in new and existing applications
- Integrated packaging contains all necessary components for installation
- The explosionproof drain allows for the safe release of gas, vapor or liquid from the electrical system to meet required codes
- Explosionproof terminal box features a simple design to provide access for quick connection of circuits
- Assembly with drain provides local "make obvious" indication of primary seal failure

Rupture Indication Sensor

- Rupture detection and indication at 60 psi
- Provides remote, immediate notification of a seal rupture, allowing for maintenance to quickly address the problem and isolate safety concerns
- Stainless steel construction provides superior corrosion resistance and durability

Ordering Information:

	Assembly with Vent/Drain	Assembly with Rupture Indication Sensor and Vent/Drain
2 wire, 14 gauge	SPS214	SPS214R
2 wire, 16 gauge	SPS216	SPS216R
2 wire, 18 gauge	SPS218	SPS218R
2 wire, 22 gauge	SPS222	SPS222R
4 wire, 14 gauge	SPS414	SPS414R
4 wire, 16 gauge	SPS416	SPS416R
4 wire, 18 gauge	SPS418	SPS418R
4 wire, 22 gauge	SPS422	SPS422R

For Process Seal Rupture Indication Sensor replacement, order catalog #PSRIS.

Options:

Description	Suffix
No terminal blocks	(leave option blank)
2 terminal blocks	DIN12
4 terminal blocks	DIN14

6F

Assembly Information

Assembly with process seal rupture indication sensor

Terminal Housing

- Cast ears on cover permit easy opening and tightening
- Neoprene o-ring meets NEMA 4 requirements
- Compact, explosionproof design
- Various termination methods available
- DIN rail mounted terminal blocks provided as option

Ultra High Pressure Seal (UHPS) (available separately)

- Rated to 1500 PSI
- 2 or 4 wire versions available
- Conductors available in 14, 16, 18, and 22 gauge
- Two foot pigtail leads
- Additional conduit seal not required

Process Seal Rupture Indication Sensor (PSRIS) (available separately)

- Switch is activated (open) when the primary seal is ruptured, by Hall Effect (magnetic)
- Switch activates at internal pressure of 60 psi or higher*
- Must be wired as intrinsically safe (Div. 1, Zone 1) or non-incendive (Div. 2, Zone 2)
- 2 meter silicon cable

Explosionproof Vent / Drain

- Patented labyrinth design
- NEMA 4 rated

Installation Example

- Explosionproof seal not required if process device or sensor is labeled "factory-sealed" or "seal not required"

*60 psi internal pressure rating at 25°C ambient. Activation pressure may vary +/- 10% depending on ambient variation.

Secondary Process Seal Assemblies

Cl. I, Div. 1 & 2, Groups B, C, D NEMA 3, 4, 7BCD, 9
 Cl. I, Zone 1 & 2 IIB + H₂
 Cl. II, Div. 1 & 2, Groups E, F, G

6F



Installation Examples

Secondary Process Seal with local "make obvious" indication using an ECD explosionproof drain

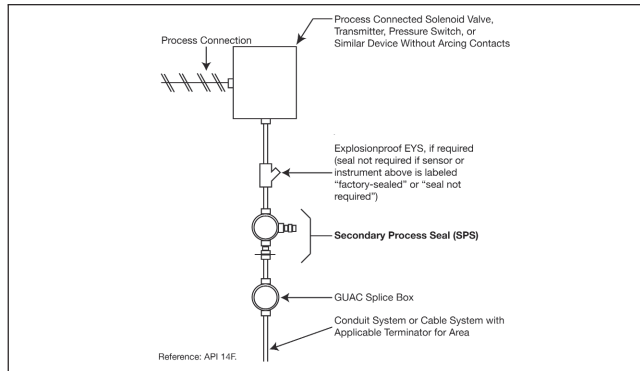

Secondary Process Seal with Rupture Indication Sensor for remote indication, and ECD explosionproof drain for local "make obvious" indication

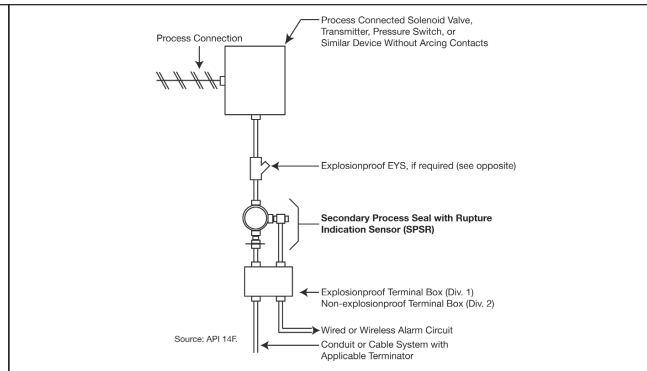

Technical Data - Assembly

Product Certification

The Secondary Process Seal and Assemblies are CSA certified (Canada, U.S.)

Operating Pressure Rating

Rupture protection to 1500 psi
 Rupture indication at 60 psi minimum

Operating Temperature Range

-25°C to +50°C

Note: For more extreme temperature and/or pressure requirements, please consult factory.

Technical Data - Components

Components	Construction	Certifications and Compliances	Rating	Area Suitability
Process Seal Rupture Indication Sensor	Hub - 316 stainless steel	ANSI / ISA 12.27.01 - 2003 CEC 18 - 108, 158 NEC 501.15(F)(3)	-	Cl. I, Div. 1 & 2, Groups B, C, D Cl. II, Div. 1 & 2, Groups E, F, G Zone 1 IIB+H ₂ and Zone 2 IIB+H ₂ NEMA 3, 4, 7BCD, 9
	Switch Assembly - hermetically sealed, nicked brass, with silicon cable	(Div. 1, Zone 1) intrinsically safe (Div. 2, Zone 2) non-incendive Simple apparatus (NEC 504.4)	174 mA 24VDC T6 (Tamb ≤ 40°C) T5 (40°C < Tamb ≤ 55°C) T4 (55°C < Tamb ≤ 80°C)	
Ultra High Pressure Seal	Stainless steel	CSA 22.2 No. 30 - 03 CSA 22.2 No. 14 - 2005 ANSI / ISA 12.27.01 - 2003 CEC 18 - 108, 158 NEC 501.15(F)(3)	24VDC 120VAC	
Terminal Housing	Copper-free aluminum	UL1203 CSA C22.2 No. 30	-	
Drain / Vent	Stainless steel	UL1203 CSA C22.2 No. 30	-	

6F Secondary Process Seal Assemblies

Cl. I, Div. 1 & 2, Groups B, C, D NEMA 3, 4, 7BCD, 9
 Cl. I, Zone 1 & 2 IIB + H₂
 Cl. II, Div. 1 & 2, Groups E, F, G

6F

Dimensions (Inches):

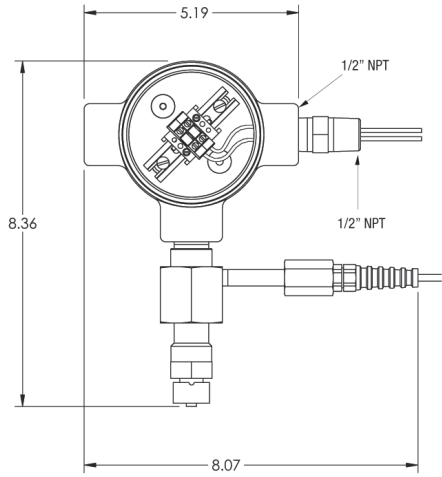

Assembly with rupture sensor and vent/drain

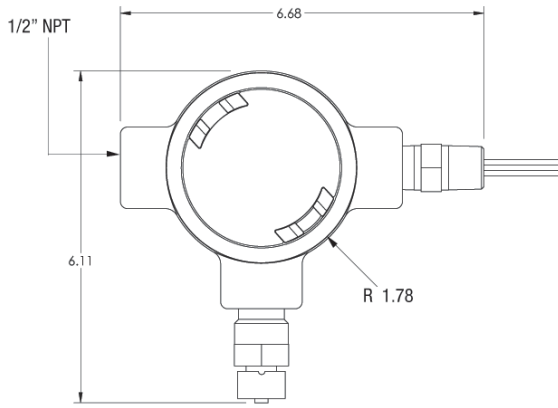

Assembly with vent/drain

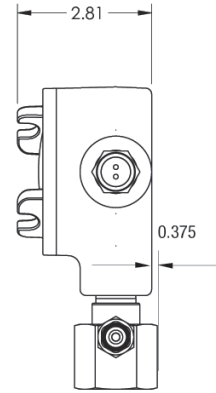

Note: Assemblies shown with DIN12 terminal blocks (optional)

Chico® A and Chico® A-P Sealing Compound

Chico® X Fiber

Chico® SpeedSeal™

For Sealing Fittings and Hubs



Applications:

Chico X fiber:

- Forms a dam between the integral bushing of the sealing fitting and the end of the conduit and around the electrical conductors entering the hub

Chico A sealing compound:

- Forms a seal around each electrical conductor and between them and inside of the sealing fitting to restrict the passage of gases, vapors or flames through the sealing fitting at atmospheric pressure and at normal ambient temperatures

Chico® SpeedSeal™ Compound:

- Designed to separate and form an explosionproof seal around each electrical conductor in Eaton's Crouse-Hinds EYS and EYD sealing fittings
- Restricts the passage of gases, vapors or flames through the sealing fitting
- Creates a seal for Class I, Division 1, Groups C, D and Class II, Division 1, Groups E, F, G hazardous areas

Features:

Chico A sealing compound:

- A water soluble powder that can be easily mixed and poured. The compound, unusually dense, expands slightly when hardening and bonds to inner walls of sealing fittings. Compound hardens in 60–70 minutes
- Chico A cure time is 8 hours for Class I, Group C and D applications and 72 hours for Class I, Group A and B applications.
- Chico A has a 1 year shelf life from date of manufacture.
- Chico A ambient temperature range (after curing) is –40°F to +165°F.

Chico A-P Intrapak®:

- Packaged in two-compartment plastic pouch with precise amount of water for mixing. No mixing or measuring implements required.
- A hard squeeze of the water compartment forces the water into the compartment containing the Chico compound. Mixing is completed by kneading the pouch for one minute.
- The mixed sealing compound is poured directly into the sealing fitting – no funnel required. The package label indicates the size and quantity of sealing fittings each pouch will properly fill. Compound hardens in 60–70 minutes.

Chico X fiber:

- A mineral wool that packs easily, forming around each conductor

Chico® SpeedSeal™ Compound:

- Installs a reliable seal in five minutes - *every time*
- Hardens to a dense, strong mass that is suitable for Class I, Division 1, Groups C, D and Class II, Division 1, Groups E, F, G hazardous applications.
- UL and cUL Listed for use with 1/2" to 2" Eaton's Crouse-Hinds sealing fittings only.
- Packaged in a 2 oz. or 6 oz. pre-measured cartridge, eliminating the need for measuring before mixing.
- Packaged with a screw-on nozzle for accurate dispensing.
- Expands four times its original size in the sealing fitting, eliminating the need to separate the individual conductors with Chico X fiber.
- Chico X fiber dams are not required in horizontal applications, reducing installation times.
- Completely hardens in 20 minutes, simplifying use for OEMs.
- Suitable for cold temperature environments without the costly need to build a temporary shelter around sealing fittings. All ice crystals must be removed from inside the conduit seal before dispensing Chico SpeedSeal compound. The Chico SpeedSeal compound should be kept above 10°C (50°F) and below 85°F (29°C) prior to mixing. The sealing fitting must be kept at or above 4°C (40°F) during the 4 to 10 minute expansion/gel time of the compound.
- 18 months shelf-life.
- Patent pending.

Size Ranges:

- *Chico A* compound – 1 lb. to 5 lbs. (provides 23–115 cubic inches of compound)
- *Chico X* fiber – 2 oz. to 1 lb.
- *Chico A-P* (5 pouches per carton) – provides 25 and 55 cubic inches of compound
- *Chico SpeedSeal* - 2 oz. or 6 oz. cartridge

Eaton's Crouse-Hinds sealing fittings are approved for use in hazardous locations only when *Chico X* fiber and *Chico A* Sealing Compound or *Chico SpeedSeal* are used to make the seal.

Ordering Information - Chico A



Net Weight	Vol. Cu. In.†	Cat. #
1 lb.	23	Chico A3
1 lb.‡	23	Chico A4
5 lb.	115	Chico A05

Ordering Information - Chico A-P Intrapak®



Cu. In. Fill per Pouch†	No. of Pouches per Carton	Cat. #
5	5	Chico A19 PX*
11	5	Chico A39 PX*

*A sixth pouch, containing an appropriate quantity of Chico X fiber, is included in these cartons.

†Number of cubic inches this amount will fill when set. See internal volume requirements for EYS, EZS, EYD, EZD and EYSR sealing fittings and ES sealing hubs (see pages 140–149).

‡Includes 1 oz. Chico X fiber.

Crouse-Hinds

by **E.T.N**

6F Chico® A and Chico® A-P Sealing Compound Chico® X Fiber Chico® SpeedSeal™ For Sealing Fittings and Hubs

6F

Ordering Information - Chico X Fiber

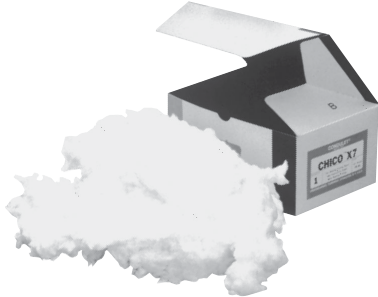

Net Weight	Cat. #
2 oz.	Chico X4
8 oz.	Chico X6
1 lb.	Chico X7

Chart for Approximate Amount of Fiber Per Hub

Hub Size	Ozs. Required
1/2	1/32
3/4	1/16
1	1/8
1 1/4	1/4
1 1/2	1/2
2	1
2 1/2	1 1/2
3	2
3 1/2	3
4	4 1/2
5	7
6	10

Ordering Information - Chico SpeedSeal

Class I, Div. 1, Groups C & D and Class II, Div. 1, Groups E, F and G



Sealing Fitting Cat. #	Amount of SpeedSeal Material needed per fitting (in ounces)	SpeedSeal Cat. #
EYS1, EYS16; EYS11, EYS116 EYD1, EYD16, EYD11, EYD116 EYS2, EYS26, EYS21, EYS216 EYD2, EYD26, EYD21, EYD216 EYSX11, EYDX11	1	CHICO SS2 (2 oz. Cartridge)
EYS3, EYS36, EYS31, EYS316 EYD3, EYD36, EYD31, EYD316 EYSX21, EYDX21	2	CHICO SS2 (2 oz. Cartridge)
EYS41, EYS416, EYS4, EYS46 EYD4, EYD46, EYD41, EYD416 EYS51, EYS516, EYS5, EYS56 EYD5, EYD56, EYD51, EYD516 EYSX31, EYDX31 EYSX41, EYDX41	3	CHICO SS6 (6 oz. Cartridge)
EYS61, EYS616, EYS6, EYS66 EYD6, EYD66, EYD61, EYD616 EYSX51, EYDX51	6	CHICO SS6 (6 oz. Cartridge)

MSDS sheets are available at www.crouse-hinds.com

For Use with Sealing Fittings and Hubs

Eaton's Crouse-Hinds EYS Tool Kit lets you safely and reliably pack the fiber dam in explosionproof sealing fittings. Consisting of five patented, two-sided tools in a handy canvas bag, the EYS Tool Kit makes the critical steps of separating electrical conductors and packing fiber dams quick and easy.

Features and Benefits:

- The EYS Tool Kit consists of five tools and a canvas tool bag. Four tools have two unique ends for a total of 9 different tools.
- Each tool is numbered for easy identification.
- Tools are constructed of durable plastic with smooth and rounded surfaces that will not abrade the electrical insulation.
- The Hook tool (#3) with a large hook on one end and a small hook on the other end is designed to lift and separate individual wires.
- The Packing tools (#1, #2 & #4) have rounded ends designed for packing fiber in between and around electrical conductors.
- The Wedge tools (#2 & #5) are designed for hands-free separation of conductors while packing fiber.
- The Mirrored tool (#5) allows for easy inspection of the sealing fittings.
- All tools are sized and precisely angled to accommodate various sizes of fittings.
- The canvas tool bag is designed to neatly store and protect tools while not in use.



Ordering Information

Description	Cat. #
EYS Tool Kit	EYS TOOL KIT

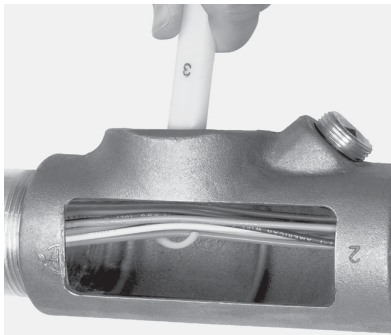

The large hook on Tool #3 quickly lifts all the conductors.

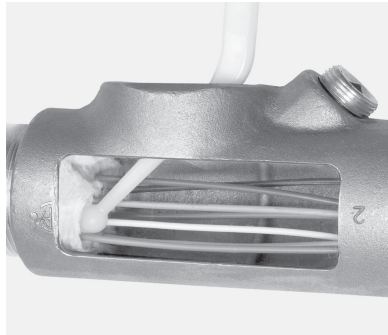

With one of the packing tools, packing fiber in between and around electrical conductors is effortless.

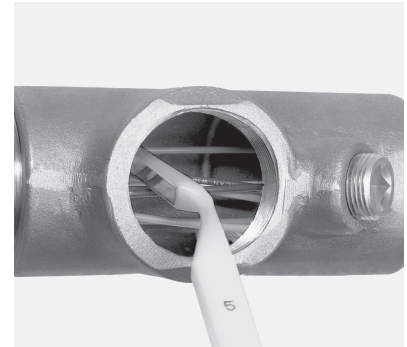

The mirrored tool allows for proper inspection of the fiber dam in difficult to see areas.

6F Drains and Breathers

Cl. I, Div. 1 & 2, Groups B, C, D
 Cl. II, Div. 1, Groups E, F, G
 Cl. II, Div. 2, Groups F, G
 Cl. III

II 2 G Ex d IIB (ECD15)
 II 2 G Ex d IIB + Hydrogen
 (ECD Type 4X Series)
 Explosionproof
 Dust-Ignitionproof

6F

Applications:

- ECD drains and breathers are installed in enclosures or conduit systems to:
 - Provide ventilation to minimize condensation
 - Drain accumulated condensate
- At least one breather should be used with each drain
- A breather is installed in top of enclosure or upper section of conduit system
- A "standard" drain is installed in bottom of enclosure or in lower section of conduit system
- "Universal" breather or drain functions as a breather when mounted at the top of an enclosure, or as a drain when mounted in the bottom of an enclosure
- "Combination" breather and drain is used in those applications where the use of a top mounted breather is not practical due to limited space; or in offshore and marine installations where moisture may enter the enclosure through the breather located on top of enclosure
- Drains and breathers are installed in hubs or drilled and tapped openings

Features:

ECD284, ECD384, ECD385 and ECD15 "Universal" drains and breathers have:

- Patented labyrinth design, suitable for use in Class I, Division 1 & 2, Groups C,D and Class II, Division 1 & 2, Groups F,G areas
- Capability to pass 50 cc of water per minute and 0.2 cubic feet of air per minute at atmospheric pressure
- ECD15 and ECD385 each have a well inside the inner, threaded end to provide for accumulation of sediment without clogging when used as a drain

"Standard" ECD drains and breathers have:

- Thread-in-thread design, suitable for use in Class I, Division 1 & 2, Groups C,D; Class II, Division 1, Groups E,F,G; Class II, Division 2, Groups F,G and Class III areas
- ECD 11, 13 have capability to pass 25 cc of water per minute and .05 cubic feet of air per minute at atmospheric pressure
- ECD387 and ECD16 are a unique thread-in-shaft design for use in Class I, Division 1 & 2, Groups B,C,D; Class II, Division 1, Groups E,F,G; Class II, Division 2, Groups F,G; Class III areas. The ECD387 and ECD16 can pass 15cc of water per minute. The ECD16 can pass .01 cubic feet of air per minute.

"Combination" ECD breather and drain:

- Provides ventilation to minimize condensation and drains accumulated condensate – two functions performed by a single device installed in the bottom of an enclosure or conduit system
- Have the capability to pass 25 cc of water per minute and .10 cubic feet of air per minute at atmospheric pressure
- Thread-in-thread and labyrinth design, suitable for use in Class I, Division 1 & 2, Groups C and D; Class II, Division 1 & 2, Groups F and G; and Class III areas

Certifications and Compliances:

- NEC/CEC:
 - ECD 16, ECD387, ECD-N4D, ECD-N4B** – Class I, Division 1 & 2, Groups B, C, D
Class II, Division 1, Groups E, F, G
Class II, Division 2, Groups F, G
Class III
IP46 (ECD-N4D and ECD-N4B only)
IIB + Hydrogen (ECD-N4D and ECD-N4B only)
 - ECD11, ECD13, ECD281** – Class I, Division 1 & 2, Groups C, D
Class II, Division 1, Groups E, F, G
Class II, Division 2, Groups F, G
Class III
 - ECD18, ECD384, ECD15, ECD385** – Class I, Division 1 & 2, Groups C, D
Class II, Division 1, Groups F, G
Class II, Division 2, Groups F, G
Class III
IP42 IIB (ECD 15 only)
 - ECD284** – Class I, Division 1 & 2, Group C, D
Class II, Division 1, Groups F, G
Class II, Division 2, Groups F, G
- UL Standard: 1203
- CSA Standard: C22.2 No. 30
- Type 4X: ECD-N4D and ECD-N4B
- ATEX Certificate # ITS07ATEX15639U

Standard Materials:

- ECD11, ECD15, ECD281, ECD284, ECD384, ECD385 – stainless steel
- ECD13 – stainless steel with aluminum cap
- ECD16, ECD-N4D, ECD-N4B – stainless steel
- ECD387 – stainless steel
- ECD18 – stainless steel with neoprene tube

Size Ranges:

- 1/4" to 1/2"

Breather



Drain

Typical installation of drain and breather in a combination motor starter

- At least 5 full threads of drain or breather must be engaged in matching female thread, taper-tapped in accordance with NEMA/EEMAC Standard FB-1, Type NTC or National Bureau of Standards Handbook H28, Part II, Table 7.6.
- These breathers and drains can be factory installed on various explosion-proof equipment. See options on applicable equipment pages for suffixes to be used.



ECD11



ECD13



ECD15



ECD16



ECD18

Ordering Information ECD "Type 4X" Drain and Breather

Size	Drain Cat. #	Breather Cat. #
3/8	ECD38 N4D	ECD38 N4B
1/2	ECD1 N4D	ECD1 N4B

ECD "Standard" Drain and Breather

Size	Drain Cat. #	Breather Cat. #
1/4	ECD281	
3/8	ECD387	
1/2	ECD11	ECD13

ECD "Universal" Drain or Breather

Size	Cat. #
1/4	ECD284†
3/8	ECD384†
3/8	ECD385
1/2	ECD15
1/2	ECD16

†Shorter overall length than ECD15 and ECD385. For use in confined spaces such as panelboard assemblies.

ECD "Combination" Drain or Breather

Size	Cat. #
1/2	ECD18

Straight Body • Male Thread

Applications:

CD Series drains are for use in conduit systems to:

- Drain accumulated condensate.
 - Provide ventilation to minimize condensation.
- Drains are installed in hubs or drilled and tapped openings.

Certifications and Compliances:

- UL Standard 514B

Standard Materials:

- CD bodies and nuts – steel or aluminum
- CD screen – stainless steel

Standard Finishes:

- Steel – electrogalvanized with chromate treatment.

Options:

Description	Suffix
Copper-free aluminum construction	SA



Ordering Information

Size	Cat. #
1/2"	CD1
3/4"	CD2

NEMA 4X Breather/Drain

I M2 II 2GD, E Exe I & II
(Stainless Steel & Brass only)
II 2GD, E Exe II (Nylon version)
CSA Class I, Division 2, Groups
A, B, C & D, Exe II

Enclosure Type 4X
IP66

ATEX and GENELEC Range

Applications:

For use in enclosures to provide a method to effectively drain moisture while allowing the enclosure to breathe.

Features:

- All NEMA 4X breather/drains offer:
- Castellated locknuts that allow moisture to pass between the enclosure and the locknut to the drain holes in the fitting.
 - Available in brass, stainless steel (Type 316) or 30% glass filled nylon.
 - Captive "O" ring on recess of the face of the breather/drain to optimize ingress protection.
 - ATEX and CSA Certified for worldwide market acceptance.
 - Available with metric or NPT threads.

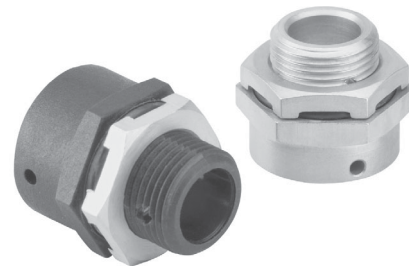

Certifications and Compliances:

- SIRA 99 ATEX 3050U
- I M2 II 2GD, E Exe I & II (Stainless Steel & Brass only)
- II 2GD, E Exe II (Nylon only)
- CSA Class I, Division 2, Groups A, B, C & D, Exe II
- Enclosure Type 4X
- IP66

Ordering Information

Entry Method	Material	Cat. #
M20	Brass	ACDPEB/M20/15
M20	Stainless Steel	ACDPES/M20/15
M20	Nylon	ACDPEN/M20/15
M25	Brass	ACDPEB/M25/15
M25	Stainless Steel	ACDPES/M25/15
M25	Nylon	ACDPEN/M25/15
1/2"	Brass	ACDPEB/050NPT/15
1/2"	Stainless Steel	ACDPES/050NPT/15
3/4"	Brass	ACDPEB/075NPT/15
3/4"	Stainless Steel	ACDPES/075NPT/15

Operating Temperature:

- -50°C to +85°C

Crouse-Hinds

by **E.T.N**

6F

6F
