

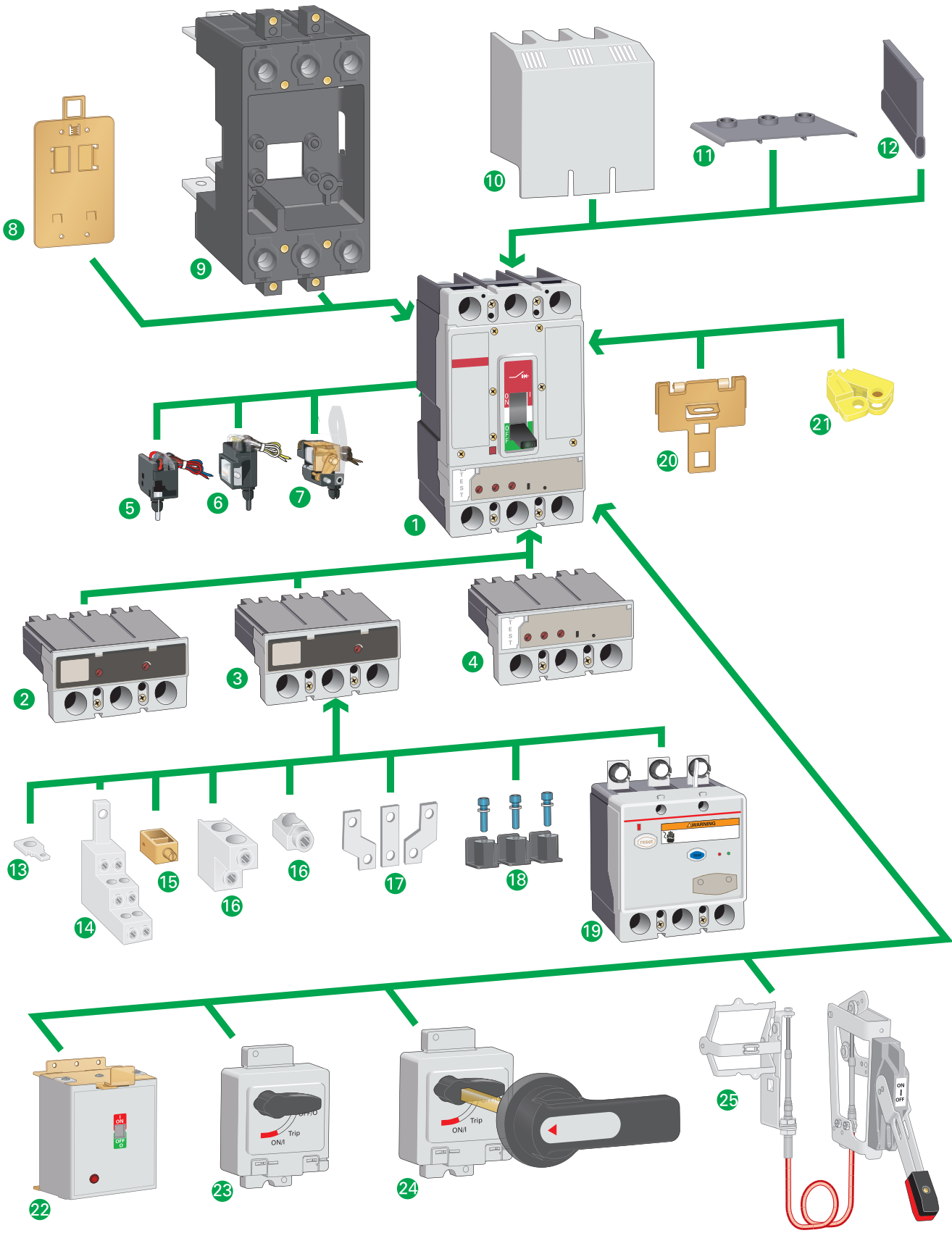

Series G Moulded Case Circuit Breakers 15 – 2500 A for IEC & NEMA Applications

Product Focus





World-class accessories include: **1** Circuit breaker **2** Thermal-magnetic trip unit, integrated on E Frame **3** Magnetic only trip unit, integrated on E Frame **4** Electronic protection trip unit, J/L Frame only **5** Auxiliary/alarm contact **6** Shunt trip **7** Undervoltage release **8** DIN-rail mounting adapter, E Frame only **9** Plug-in block **10** Terminal cover **11** Terminal end cover **12** Interphase barrier **13** Control wire kit **14** Multiwire connector **15** Steel cable terminal **16** Aluminum/copper terminal **17** Terminal spreader **18** Endcap kit **19** Earth leakage module, side mounted on E Frame **20** Padlockable handle lock hasp **21** Padlockable handle block **22** Motor operator **23** Direct close coupled handle mechanism **24** Through-the-door handle mechanism **25** Flex Shaft handle mechanism

<i>Description</i>	<i>Page</i>
Standards	1
General Information	2
Typical Applications	3
Electrical Characteristics	4
Multi-Function Electronic Trip Units	10
Electronic Trip Unit Selection Guide	12
Breaker Ordering Information/ Catalogue Numbers/ Termination Accessories	
GE-Frame, 15 – 160 Amperes	13
GJ-Frame, 20 – 250 Amperes	17
GL-Frame, 100 – 630 Amperes	21
GN-Frame, 400 – 1250 Amperes	26
GN-Frame, 1600 Amperes	29
GR-Frame, 800 – 2500 Amperes	30
Motor Circuit Protectors	35
30 mA Ground Fault (Earth Leakage) Modules	36
Special Features and Accessories	37
Plug-in Blocks and Drawout Cassettes	40
Handle Mechanisms	41
Time Current Curves	44
Current Limiting Curves	52
Dimensions	53

Standards

Eaton Moulded Case Circuit Breakers from Eaton’s electrical business are designed to conform with the following international standards:

- Australian Standard AS 2184 and AS 3947-2 Moulded Case Circuit Breakers.
- British Standards Institution Standard BS 4752: Part 1, Switchgear and Control Gear Part 1, Circuit Breakers.
- International Electrotechnical Commission Recommendations IEC 60947.2 Circuit Breakers. **CE**
- Japanese T-Mark Standard Moulded Case Circuit Breakers.
- National Electrical Manufacturers Association Standards Publication No. AB1-1975 Moulded Case Circuit Breakers.
- South African Bureau of Standards, Standard SABS 156, Standard Specification for Moulded Case Circuit Breakers.
- Swiss Electro-Technical Association Standard SEV 947.2, Safety Regulations for Circuit Breakers.
- Union Technique de l’Electricite Standard NF C 63-120, Low Voltage Switchgear and Control Gear Circuit Breaker Requirements.
- Verband Deutscher Elektrotechnike (Association of German Electrical Engineers) Standard VDE 0660, Low Voltage Switchgear and Control Gear, Circuit Breakers.

Trademarks

Cutler-Hammer is a federally registered trademark of Eaton Corporation.

CSA is a registered trademark of Canadian Standards Association.

UL is a registered trademark of Underwriters Laboratories Inc.

ISO is the registered trademark and sole property of the International Organization for Standardization.

NEMA is the registered trademark and service mark of the National Electrical Manufacturers Association.

Global Third Party Certification

Certification marks ensure product compliance with the total standard via the third party witnessing of tests by globally recognized independent certification organizations.

KEMA is a highly recognized, independent international organization that offers certification and inspection facilities for equipment in many industries. The KEMA-KEUR mark is the highest certification an electrical product can receive from KEMA. Our IEC 60947-2 Moulded Case Circuit Breakers are KEMA tested and certified. These breakers are also listed in accordance with UL® 489, as well as CSA C22.2 No. 5-02.

KEMA and UL provide ongoing follow-up testing and inspections to ensure that Eaton Moulded Case Circuit Breakers continue to meet their exacting standards.

Note: The Eaton Series G Frames GE, GJ, GL, GN and GR, although they are UL and CSA approved, do not carry the UL and CSA labels on the breakers. For applications that require UL/CSA labels, please contact your Eaton representative.

Frame Sizes GE through GR (15 – 2500 Amperes)

General Information

Eaton Series G Moulded Case Circuit Breakers provide increased performance in considerably less space than standard circuit breakers or comparable fusible devices.

The “G” signifies global applications: Series G circuit breakers are marked with UL, CSA®, CE, IEC and KEMA KEUR listings. Other advantages include:

- Field-fit accessories.
- Common accessories through 630 amperes.
- Electronic trip units from 20 to 2500 amperes.
- UL-listed and IEC-rated, 30 mA ground fault/earth leakage modules.
- Built-in ground fault protection down to 20 amperes.

The GE, GJ and GL frames are new circuit breakers designed around space-saving footprints. The GN and GR use the proven Cutler-Hammer Series C® ND and RD designs but use metric threading on their line and load conductors.

Eaton Series G Circuit Breakers meet applicable UL 489 and IEC 60947-2 standards.

The Eaton Series G family includes five frame sizes in ratings from 15 to 2500 amperes. Series G offers a choice of several interrupting capacities up to 100 kA at 480 volts ac (200 kA at 240 volts ac).

Standard calibration is 40°C. For applications in high ambient temperature conditions, 50°C factory calibration is available on thermal magnetic breakers.

The Most Logically Designed Contact Assembly

The flexibility and outstanding performance characteristics of Eaton Circuit Breakers are made possible by the best contact designs in circuit breaker history. Our patented technology creates a high-speed “blow-open” action using the electromechanical forces produced by high-level fault currents.

Eaton Circuit Breakers are operated by a toggle-type mechanism that is mechanically trip-free from the handle so that the contacts cannot be held closed against short circuit currents. Tripping due to overload or short circuits is clearly indicated by the position on the handle. This remarkably fast and dependable contact action is designed to enhance safety.

Thorough In-Plant Testing

The quality, dependability and reliability of every Eaton Circuit Breaker is ensured by a thorough program of in-plant testing. Two calibration tests are conducted on every pole of every circuit breaker to verify the trip mechanism, operating mechanism, continuity and accuracy.

ISO Certification

Eaton Circuit Breakers are manufactured in ISO® certified facilities.

Current Limiting Characteristics

Eaton Series G Circuit Breakers are current limiting because of their high repulsion contact arrangement and use of state-of-the-art arc extinguishing technology.

Operating Mechanisms

Eaton Circuit Breakers have a toggle handle operating mechanism, which also serves as a switching position indicator. The indicator shows the positions of: ON, OFF and TRIPPED.

The toggle handle snaps into the TRIPPED position if the breaker is tripped by one of its overcurrent, short circuit, shunt or undervoltage releases. Before the circuit breaker can be reclosed following a trip-out, the toggle handle must be brought beyond the OFF position (RESET). The circuit breaker can then be reclosed.

As an additional switching position indicator for GE- to GR-Frame circuit breakers, there are two windows on the right and on the left of the toggle handle, in which the switching state is indicated by means of the colors red, green and white corresponding to the ON, OFF and TRIPPED positions respectively.

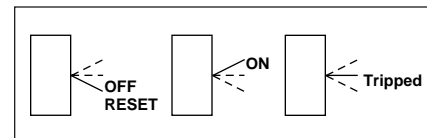

Figure 1. Positions of the Toggle Handle Drive

Typical Applications

Machine Tool Control Panels and Motor Control Centers

Designed for these equipment requirements, including new world-class accessories.

Panelboards

As both main and branch circuit protection devices.

Feeder Pillars

In distribution systems to provide main and branch circuit protection.

Switchgear

In distribution systems to provide main and branch circuit protection up to 2500 amperes (GR-Frame).

Bus Bar Trunking Tap-Offs

In bus bar trunking tap-offs to provide circuit protection.

Individual Enclosures

Completely assembled in enclosures to meet specific customer requirements.

Additional Applications

Special versions of each Cutler-Hammer frame are available to provide safe equipment control and protection in mining and other applications. Contact your Eaton agent or distributor for additional information.

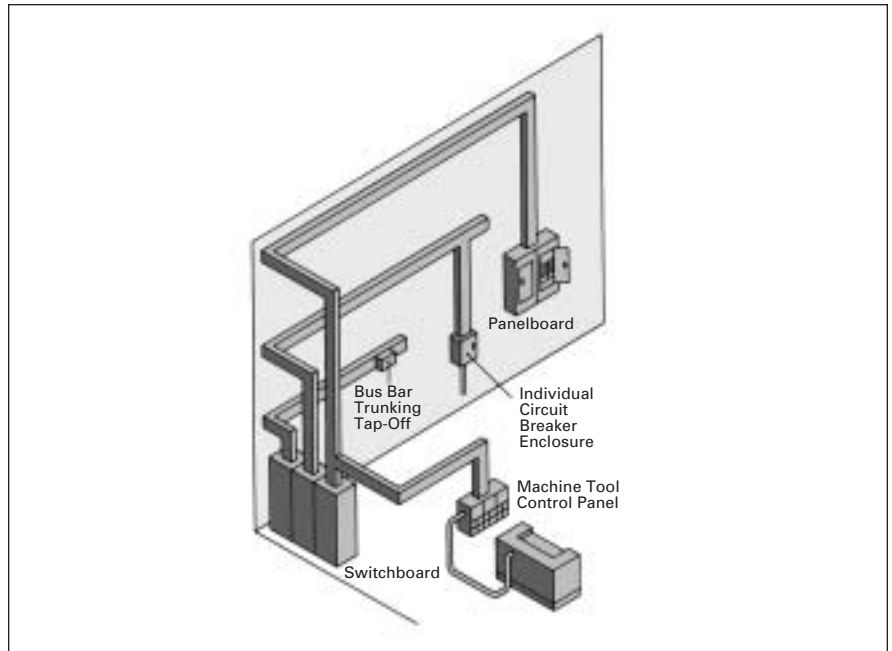

Figure 2. Typical Eaton Applications

Table 1. Typical Eaton Applications

Frame	Continuous Ampere Rating Range	Trip Unit Type					Moulded Case Switch
		Adjustable Thermal Fixed Magnetic	Fixed Thermal Fixed Magnetic	Adjustable Thermal Adjustable Magnetic	30 mA Ground Fault/Earth Leakage	Digitrip™ RMS Electronic Trip Units	
E	15 – 160 ①	■	■	—	■	—	■
J	20 – 250	—	—	■	■	■	■
L	100 – 630 ②	—	—	■	■	■	■
N	400 – 1600 ③	—	—	—	—	■	■
R	800 – 2500	—	—	—	—	■	■



① 125 amperes is the maximum NEMA rating for the GE.

② 630 amperes is not NEMA rated. 600 amperes is the maximum NEMA rating for the GL.

③ 1200 amperes is the maximum NEMA rating for the GN.

Electrical Characteristics

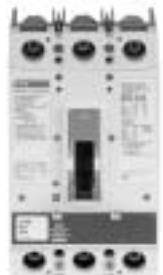
Table 2. Electrical Characteristics

Maximum Rated Current (Amperes)		GE								GJ				GL					
																			
		125, 160 ^①								250				400, 630 ^②					
Breaker Type		B		E		S		H		E	S	H	C	E	S	H	C		
Number of Poles		1	2, 3, 4 ^③		2, 3, 4 ^③		1	2, 3, 4 ^③		1	2, 3, 4 ^③		2, 3, 4 ^③		3, 4 ^③				
Breaker Capacity (kA rms) ac 50 – 60 Hz																			
NEMA®, UL, CSA	240 Vac	25	25	35	85	85	100	100	65	85	100	200	65	85	100	200			
	480 Vac	—	18	25	—	35	—	65	25	35	65	100	35	50	65	100			
	600 Vac	—	—	—	—	—	—	—	18	25	35	50	18	25	35	50			
	250 Vdc ^④	10	10	10	35	35	42	42	10	35	42	42	22	22	42	42			
IEC 60947-2	220 – 240 Vac	I_{CU}	25	25	35	85	85	100	100	65	85	100	200	65	85	100	200		
		I_{CS}	25	25	35	43	43	50	50	65	85	100	150	65	85	100	150		
	380 – 415 Vac	I_{CU}	—	18	25	—	40	—	70	25	40	70	100	35	50	70	100		
		I_{CS}	—	18	25	—	30	—	35	25	40	70	75	35	50	70	75		
	660 – 690 Vac	I_{CU}	—	—	3	—	4	—	6	12	12	14	20	12	20	25	35		
		I_{CS}	—	—	3	—	3	—	3	6	6	7	10	6	10	13	18		
	250 Vdc ^④	I_{CU}	10	10	10	35	35	42	42	10	35	42	42	22	22	42	42		
		I_{CS}	10	10	10	35	35	42	42	10	35	42	42	22	22	42	42		
Ampere Range		15 – 160 A ^①								20 – 250 A				100 – 630 A ^②					
Trip Units F= Fixed A= Adjustable T= Thermal M= Magnetic		FT-FM AT-FM								FT-AM AT-AM Electronic (Digitrip RMS 310)				FT-AM AT-AM Electronic (Digitrip RMS 310)					
Interchangeable		—								■				■					
Built-in		■								■				■					
Thermal Magnetic	Fixed Thermal	■								■				■					
	Adjustable Thermal	■								■				■					
	Magnetic	Fixed								Adjustable				Adjustable					
Electronic rms ^⑤	LS	—								■				■ ^④					
	LSI	—								■				■ ^④					
	LSG	—								■				■ ^④					
	LSIG	—								■				■ ^④					
Dimensions mm (Inches)	1-Pole	H		W		D		H		W		D		H		W		D	
	2-Pole	139.7 (5.50)		25.4 (1.00)		76.0 (2.99)		—		—		—		—		—		—	
	3-Pole			50.8 (2.00)				177.8 (7.00)		105.0 (4.13)		87.4 (3.57)		258.0 (10.13)		140.0 (5.48)		104.0 (4.09)	
	4-Pole			76.2 (3.00)						135.6 (5.34)						183.0 (7.22)			
Weight (approximate) kg (lbs.)		1-Pole		2-Pole		3-Pole		4-Pole		2-Pole		3-Pole		4-Pole		3-Pole		4-Pole	
		0.5 (1.1)		0.9 (2.0)		1.4 (3.1)		1.8 (3.9)		5.2 (11.4)		5.2 (11.4)		7.0 (15.3)		7.3 (16.0)		9.1 (20.0)	
Utilization Category		A								A				A					

^① 125 amperes is the maximum NEMA rating for the GE.



^② 630 amperes is not NEMA rated. 600 amperes is the maximum NEMA rating for the GL.

^③ Neutral on left side.

^④ Two poles in series.

^⑤ Not suitable for dc application. 4-pole ground fault not available with neutral protection.

Table 2. Electrical Characteristics (Continued)

Maximum Rated Current (Amperes)	GN ①					GR ①		
								
	800, 1250			1600 ②		1600, 2000, 2500		
Breaker Type	S	H	C ③		S	H	H	C ③
Number of Poles	2, 3, 4 ④			2, 3, 4 ④		3, 4 ④		

Breaker Capacity (kA rms) ac 50 – 60 Hz

NEMA, UL, CSA	240 Vac		65	100	200	—	—	125	200		
	480 Vac		50	65	100	—	—	65	100		
	600 Vac		25	35	50	—	—	50	65		
IEC 60947-2	220 – 240 Vac	<i>I_{cu}</i>	85	100	200	85	100	135	200		
		<i>I_{cs}</i>	85	100	100	85	100	100	100		
	380 – 415 Vac	<i>I_{cu}</i>	50	70	100	50	70	70	100		
		<i>I_{cs}</i>	50	50	50	50	50	50	50		
	660 – 690 Vac	<i>I_{cu}</i>	20 ⑤	25 ⑤	35	20 ⑤	25	25 ⑤	35 ⑤		
		<i>I_{cs}</i>	10	13	18	10	13	13	18		
250 Vdc	<i>I_{cu}</i>	—	—	—	—	—	—	—			
	<i>I_{cs}</i>	—	—	—	—	—	—	—			
Ampere Range	400 – 1250 A				1600 A		800 – 2500 A				
Trip Units	Electronic (Digitrip RMS 310)								Electronic (Digitrip RMS 310, 610 and 910)		
	Interchangeable	—								—	
	Built-in	■								■	
Electronic ⑥	LI	—								■ ⑦	
	LS	■								■	
	LSI	■								■	
	LIG	—								■ ⑦	
	LSG	■								■	
	LSIG	■								■	
Dimensions mm (Inches)	1-Pole 2-Pole 3-Pole 4-Pole	H	W	D		H	W	D			
		—	—	—		—	—	—			
		406.0 (16.00)	210.0 (8.25)	140.0 (5.50)		406.0 (16.00)	394.0 (15.50)	229.0 (9.75)			
		—	280.0 (11.13)	—		—	508.0 (20.00)	—			
Weight (approximate) kg (lbs.)	3-Pole		4-Pole		3-Pole		4-Pole				
	21.3 (46.8)		28.3 (62.0)		47.0 (103.0)		54.0 (118.4)				
Utilization Category	A				A						

① The GN and GR MCCBs use metric threading in their line and load terminals. If English (Imperial) threading is needed, use Series C ND and RD MCCBs. Contact Eaton for more information.
 ② GN 1600 ampere frame is not NEMA rated.
 ③ Not KEMA-KEUR listed.
 ④ Neutral on right side.
 ⑤ IEC 60947-2 H.5 Annex H is not KEMA-KEUR tested.
 ⑥ Not suitable for dc application. 4-pole ground fault not available with neutral protection.
 ⑦ Available only on Digitrip 610 and 910 trip units.

Frame Sizes GE through GR
Table 3. GE through GR Electrical Characteristics

Technical Data	GE	GJ	GL	GN	GR																																																																																																																																																																																																																									
Maximum Rated Current I_n Depending on the Version	160 A ^①	250 A	400, 630 A ^②	800, 1200, 1600 A ^③	1600, 2000, 2500 A																																																																																																																																																																																																																									
Rated Insulation Voltage U, According to IEC 60947-2 Main Conducting Paths Auxiliary Circuits	690 Vac 690 Vac	750 Vac 690 Vac	750 Vac 690 Vac	750 Vac 690 Vac	750 Vac 690 Vac																																																																																																																																																																																																																									
Rated Impulse Withstand Voltage U_{imp} Main Conducting Paths Auxiliary Circuits	6 kV 4 kV	8 kV 4 kV	8 kV 4 kV	8 kV 4 kV	8 kV 4 kV																																																																																																																																																																																																																									
Rated Operational Voltage U_e IEC NEMA	690 Vac 600 Y/347 Vac	690 Vac 600 Vac	690 Vac 600 Vac	690 Vac 600 Vac	690 Vac 600 Vac																																																																																																																																																																																																																									
UL and CSA Listed	Yes ^④	Yes ^④	Yes ^④	Yes ^④	Yes ^④																																																																																																																																																																																																																									
Permissible Ambient Temperature	-20 to +70°C	-20 to +70°C	-20 to +70°C	-5 to +60°C	-5 to +60°C																																																																																																																																																																																																																									
Permissible Load for Various Ambient Temperatures Close to the Circuit Breaker, Related to the Rated Current of the Circuit Breaker	<table border="1"> <thead> <tr> <th rowspan="2"></th> <th colspan="2">⑤</th> <th colspan="2">⑥</th> <th colspan="2">⑤</th> <th colspan="2">⑥</th> <th rowspan="2">—</th> <th rowspan="2">—</th> </tr> <tr> <th>⑤</th> <th>⑥</th> <th>⑤</th> <th>⑥</th> <th>⑤</th> <th>⑥</th> <th>⑤</th> <th>⑥</th> </tr> </thead> <tbody> <tr> <td>■ Circuit Breakers for Plant Protection</td> <td colspan="10"></td> </tr> <tr> <td>– At 40°C</td> <td>100%</td> <td>100%</td> <td>100%</td> <td>100%</td> <td>100%</td> <td>100%</td> <td>100%</td> <td>100%</td> <td>100%</td> <td>100%</td> </tr> <tr> <td>– At 50°C</td> <td>96%</td> <td>92%</td> <td>96%</td> <td>94%</td> <td>96%</td> <td>91%</td> <td>91%</td> <td>91%</td> <td>91%</td> <td>91%</td> </tr> <tr> <td>– At 55°C</td> <td>93%</td> <td>87%</td> <td>94%</td> <td>90%</td> <td>93%</td> <td>86%</td> <td>85%</td> <td>85%</td> <td>85%</td> <td>85%</td> </tr> <tr> <td>– At 60°C</td> <td>91%</td> <td>83%</td> <td>92%</td> <td>87%</td> <td>90%</td> <td>82%</td> <td>81%</td> <td>81%</td> <td>81%</td> <td>81%</td> </tr> <tr> <td>– At 70°C</td> <td>86%</td> <td>73%</td> <td>88%</td> <td>80%</td> <td>84%</td> <td>70%</td> <td>—</td> <td>—</td> <td>—</td> <td>—</td> </tr> <tr> <td>■ Circuit Breakers for Motor Protection</td> <td colspan="10"></td> </tr> <tr> <td>– At 40°C</td> <td>—</td> <td>—</td> <td>100%</td> <td>—</td> <td>100%</td> <td>—</td> <td>—</td> <td>—</td> <td>—</td> <td>—</td> </tr> <tr> <td>– At 50°C</td> <td>—</td> <td>—</td> <td>100%</td> <td>—</td> <td>100%</td> <td>—</td> <td>—</td> <td>—</td> <td>—</td> <td>—</td> </tr> <tr> <td>– At 55°C</td> <td>—</td> <td>—</td> <td>100%</td> <td>—</td> <td>100%</td> <td>—</td> <td>—</td> <td>—</td> <td>—</td> <td>—</td> </tr> <tr> <td>– At 60°C</td> <td>—</td> <td>—</td> <td>100%</td> <td>—</td> <td>100%</td> <td>—</td> <td>—</td> <td>—</td> <td>—</td> <td>—</td> </tr> <tr> <td>– At 70°C</td> <td>—</td> <td>—</td> <td>90%</td> <td>—</td> <td>90%</td> <td>—</td> <td>—</td> <td>—</td> <td>—</td> <td>—</td> </tr> <tr> <td>■ Circuit Breakers for Starter Combinations and Isolating Circuit Breakers</td> <td colspan="10"></td> </tr> <tr> <td>– At 40°C</td> <td>100%</td> <td>—</td> <td>100%</td> <td>—</td> <td>100%</td> <td>—</td> <td>100%</td> <td>—</td> <td>100%</td> <td>—</td> </tr> <tr> <td>– At 50°C</td> <td>100%</td> <td>—</td> <td>100%</td> <td>—</td> <td>100%</td> <td>—</td> <td>91%</td> <td>—</td> <td>91%</td> <td>—</td> </tr> <tr> <td>– At 55°C</td> <td>96%</td> <td>—</td> <td>96%</td> <td>—</td> <td>95%</td> <td>—</td> <td>85%</td> <td>—</td> <td>85%</td> <td>—</td> </tr> <tr> <td>– At 60°C</td> <td>91%</td> <td>—</td> <td>82%</td> <td>—</td> <td>90%</td> <td>—</td> <td>81%</td> <td>—</td> <td>81%</td> <td>—</td> </tr> <tr> <td>– At 70°C</td> <td>86%</td> <td>—</td> <td>88%</td> <td>—</td> <td>84%</td> <td>—</td> <td>—</td> <td>—</td> <td>—</td> <td>—</td> </tr> </tbody> </table>						⑤		⑥		⑤		⑥		—	—	⑤	⑥	⑤	⑥	⑤	⑥	⑤	⑥	■ Circuit Breakers for Plant Protection											– At 40°C	100%	100%	100%	100%	100%	100%	100%	100%	100%	100%	– At 50°C	96%	92%	96%	94%	96%	91%	91%	91%	91%	91%	– At 55°C	93%	87%	94%	90%	93%	86%	85%	85%	85%	85%	– At 60°C	91%	83%	92%	87%	90%	82%	81%	81%	81%	81%	– At 70°C	86%	73%	88%	80%	84%	70%	—	—	—	—	■ Circuit Breakers for Motor Protection											– At 40°C	—	—	100%	—	100%	—	—	—	—	—	– At 50°C	—	—	100%	—	100%	—	—	—	—	—	– At 55°C	—	—	100%	—	100%	—	—	—	—	—	– At 60°C	—	—	100%	—	100%	—	—	—	—	—	– At 70°C	—	—	90%	—	90%	—	—	—	—	—	■ Circuit Breakers for Starter Combinations and Isolating Circuit Breakers											– At 40°C	100%	—	100%	—	100%	—	100%	—	100%	—	– At 50°C	100%	—	100%	—	100%	—	91%	—	91%	—	– At 55°C	96%	—	96%	—	95%	—	85%	—	85%	—	– At 60°C	91%	—	82%	—	90%	—	81%	—	81%	—	– At 70°C	86%	—	88%	—	84%	—	—	—	—	—
	⑤		⑥		⑤		⑥		—	—																																																																																																																																																																																																																				
	⑤	⑥	⑤	⑥	⑤	⑥	⑤	⑥																																																																																																																																																																																																																						
■ Circuit Breakers for Plant Protection																																																																																																																																																																																																																														
– At 40°C	100%	100%	100%	100%	100%	100%	100%	100%	100%	100%																																																																																																																																																																																																																				
– At 50°C	96%	92%	96%	94%	96%	91%	91%	91%	91%	91%																																																																																																																																																																																																																				
– At 55°C	93%	87%	94%	90%	93%	86%	85%	85%	85%	85%																																																																																																																																																																																																																				
– At 60°C	91%	83%	92%	87%	90%	82%	81%	81%	81%	81%																																																																																																																																																																																																																				
– At 70°C	86%	73%	88%	80%	84%	70%	—	—	—	—																																																																																																																																																																																																																				
■ Circuit Breakers for Motor Protection																																																																																																																																																																																																																														
– At 40°C	—	—	100%	—	100%	—	—	—	—	—																																																																																																																																																																																																																				
– At 50°C	—	—	100%	—	100%	—	—	—	—	—																																																																																																																																																																																																																				
– At 55°C	—	—	100%	—	100%	—	—	—	—	—																																																																																																																																																																																																																				
– At 60°C	—	—	100%	—	100%	—	—	—	—	—																																																																																																																																																																																																																				
– At 70°C	—	—	90%	—	90%	—	—	—	—	—																																																																																																																																																																																																																				
■ Circuit Breakers for Starter Combinations and Isolating Circuit Breakers																																																																																																																																																																																																																														
– At 40°C	100%	—	100%	—	100%	—	100%	—	100%	—																																																																																																																																																																																																																				
– At 50°C	100%	—	100%	—	100%	—	91%	—	91%	—																																																																																																																																																																																																																				
– At 55°C	96%	—	96%	—	95%	—	85%	—	85%	—																																																																																																																																																																																																																				
– At 60°C	91%	—	82%	—	90%	—	81%	—	81%	—																																																																																																																																																																																																																				
– At 70°C	86%	—	88%	—	84%	—	—	—	—	—																																																																																																																																																																																																																				
Rated Short Circuit Breaking Capacity (dc) Not for Circuit Breakers for Motor Protection (Time Constant $\tau = 10$ rms) 2 Conducting Paths in Series For GE to GL up to 250 Vdc NEMA (Time Constant $\tau = 8$ rms) 2 Conducting Paths in Series 250 Vdc	42 kA Max. 42 kA Max.	42 kA Max. 42 kA Max.	42 kA Max. 42 kA Max.	⑦ ⑦ ⑦	⑦ ⑦ ⑦																																																																																																																																																																																																																									
Main Switch Characteristics According to IEC 60947-2 in Combination with Lockable Rotary Drives	Yes	Yes	Yes	Yes	Yes																																																																																																																																																																																																																									
Rated Short Circuit Breaking Capacity According to IEC 60947-2 (at ac 50/60 Hz)	Rated Short Circuit Breaking Capacity See Table 2 on Page 4																																																																																																																																																																																																																													
Endurance (Operating Cycles)	10,000	10,000	8,000	3,000	3,000																																																																																																																																																																																																																									
Maximum Switching Frequency	300 1/h	240 1/h	240 1/h	60 1/h	20 1/h																																																																																																																																																																																																																									

^① 125 amperes is the maximum NEMA rating for the GE.

^② 630 amperes is not NEMA rated. 600 amperes is the maximum NEMA rating for the GL.

^③ 1200 amperes is the maximum NEMA rating for the GN.

^④ See footnotes for exceptions.

^⑤ Thermal overload release set to the lower value.

^⑥ Thermal overload release set to the upper value.

^⑦ Not suitable for dc switching.

Table 3. GE through GR Electrical Characteristics (Continued)

Technical Data	GE	GJ	GL	GN	GR	
Conductor Cross Sections and Terminal Types for Main Conductors ■ Solid or Stranded ■ Finely Stranded with End Sleeve ■ Bus Bar Tightening Torque for Box Terminals Tightening Torque for Bus Bar Connection Pieces	Box Terminals 2.5 to 95 mm ² 2.5 to 50/70 mm ² — 5.6 Nm 5.6 Nm	Box Terminals 50 to 150 mm ² 35 to 120 mm ² — 20 Nm 15 Nm	Box Terminals 95 to 240 mm ² 70 to 150 mm ² — 42 Nm 30 Nm	Flat Bar Terminals — — 600 A 31 Nm 6 Nm	Flat Bar Terminals — — Optional 31 Nm 50 Nm	Flat Bar Terminals — — Optional — 20 Nm
Conductor Cross Sections for Auxiliary Circuits with Terminal Connection or Terminal Strip ■ Solid ■ Finely Stranded with End Sleeve ■ With Brought-out Cable Ends ■ Tightening Torque for Fitting Screws	0.75 to 2.5 mm ² 0.75 to 2.5 mm ²	0.75 to 2.5 mm ² 0.75 to 2.5 mm ² 0.82 (AWG 18) mm ² 0.8 to 1.4 Nm	0.75 to 2.5 mm ² 0.75 to 2.5 mm ² 0.82 (AWG 18) mm ² 0.8 to 1.4 Nm	Up to 2x4 mm ² Up to 2x2.5 mm ² 0.82 (AWG 18) mm ² 0.8 to 1.4 Nm	Up to 2x4 mm ² Up to 2x2.5 mm ² 0.82 (AWG 18) mm ² 0.8 to 1.4 Nm	
Power Loss per Circuit Breaker at Maximum Rated Current I_n (The Power Losses of the Undervoltage Releases ("r" Releases) Must Be Observed if Necessary) at Three-Phase Symmetrical Load) ■ For Plant Protection ■ As Isolating Circuit Breaker ■ For Starter Combinations ■ For Motor Protection	50 W 40 W 40 W —	75 W 75 W 45 W 75 W	255 W 160 W 160 W 120 W	87/210 W 87/210 W — —	220/270/400 W 220/270/400 W — —	
Permissible Mounting Position						
Arc Spacing — Suitable for Reverse-Feed Applications	Yes (Except HMCPE)	Yes	Yes	Yes	Yes	

Frame Sizes GE through GR
Table 3. GE through GR Electrical Characteristics (Continued)

Technical Data	GE	GJ	GL	GN	GR
Auxiliary Switches					
Rated Thermal Current I_{th} Rated Making Capacity	6 A 20 A	6 A 20 A	6 A 20 A	6 A 20 A	6 A 20 A
ac (ac-15) <ul style="list-style-type: none"> ■ Rated Operational Voltage ■ Rated Operational Current 	230/400/600 V 6/3/0.25 A	230/400/600 V 6/3/0.25 A	230/400/600 V 6/3/0.25 A	600 V 6 A	600 V 6 A
dc (dc-13) <ul style="list-style-type: none"> ■ Rated Operational Voltage ■ Rated Operational Current 	125/250 V 0.5/0.25 A	125/250 V 0.5/0.15 A	125/250 V 0.5/0.15 A	125/250 V 0.5/0.25 A	125/250 V 0.5/0.25 A
Backup Fuse Miniature Circuit Breaker	6/4/4 A 6/4 A	4 6/4/4 A 6/4 A	4 6/4/4 A 6/4 A	4 6/4/4 A 6/4 A	4 6/4/4 A 6/4 A
Releases					
Undervoltage Releases ("r" Releases) Response Voltage: <ul style="list-style-type: none"> ■ Drop (Breaker Tripped) U_S ■ Pickup (Breaker May Be Switched on) U_S 	35 – 70% 85 – 110%	35 – 70% 85 – 110%	35 – 70% 85 – 110%	35 – 70% 85 – 110%	35 – 70% 85 – 110%
Power Consumption in Continuous Operation at: <ul style="list-style-type: none"> ■ 50/60 Hz 12 Vac ■ 50/60 Hz 24 Vac ■ 50/60 Hz 48 – 60 Vac ■ 50/60 Hz 110 – 127 Vac ■ 50/60 Hz 208 – 240 Vac ■ 50/60 Hz 380 – 500 Vac ■ 50/60 Hz 525 – 600 Vac ■ 12 Vdc ■ 24 Vdc ■ 48 – 60 Vdc ■ 110 – 125 Vdc ■ 220 – 250 Vdc 	0.95 VA 0.72 VA 1.15 – 1.78 VA 0.96 – 1.25 VA 1.28 – 1.68 VA 2.2 – 3.9 VA 3.4 – 4.3 VA 0.88 W 0.70 W 1.12 – 1.76 W 0.94 – 1.21 W 1.45 – 1.86 W	1.9 VA 3.9 VA 2.5 – 3.8 VA 1.8 – 2.4 VA 2.7 – 3.8 VA 3.4 – 5.8 VA 3.4 – 4.3 VA 1.6 W 3.1 W 2.0 – 3.1 W 1.6 – 2.2 W 3.1 – 4 W	1.9 VA 3.9 VA 2.5 – 3.8 VA 1.8 – 2.4 VA 2.7 – 3.8 VA 3.4 – 5.8 VA 3.4 – 4.3 VA 1.6 W 3.1 W 2.0 – 3.1 W 1.6 – 2.2 W 3.1 – 4 W	1.9 VA 2.4 VA 2.3 – 4.1 VA 3.4 – 4.2 VA 4.8 – 6.5 VA 6.8 – 12.0 VA — 2.6 W 3.6 W 3.5 – 5.5 W 2.9 – 3.6 W 4.8 – 6.3 W	2.9 VA 3.1 VA 3.4 – 6.0 VA 3.3 – 3.8 VA 4.2 – 7.2 VA 3.8 – 10.0 VA — 3.4 W 4.3 W 4.8 – 7.2 W 3.3 – 3.8 W 6.6 – 7.5 W
Maximum Opening Time	50 ms	50 ms	50 ms	62 ms	62 ms
Shunt Trips					
Shunt Trips ("f" Releases) Response Voltage: <ul style="list-style-type: none"> ■ Pickup (Breaker Tripped) U_S 	70 – 110%	70 – 110%	70 – 110%	70 – 110%	70 – 110%
Power Consumption in (Short Time) at: <ul style="list-style-type: none"> ■ 50/60 Hz 24 Vac ■ 50/60 Hz 48 – 60 Vac ■ 50/60 Hz 48 – 127 Vac ■ 50/60 Hz 110 – 240 Vac ■ 50/60 Hz 380 – 440 Vac ■ 50/60 Hz 380 – 600 Vac ■ 50/60 Hz 480 – 600 Vac ■ 12 – 24 Vdc ■ 48 – 60 Vdc ■ 110 – 125 Vdc ■ 220 – 250 Vdc 	10 – 41 VA 139 – 210 VA — 83 – 360 VA — 418 – 1080 VA — 29 – 120 W 475 – 720 W 99 – 121 W —	87 – 405 VA 710 – 1105 VA — 66 – 432 VA 127 – 188 VA — 34 – 60 VA 164 – 631 W 830 – 1580 W 112 – 150 W 40 – 58 W	87 – 405 VA 710 – 1105 VA — 66 – 432 VA 127 – 188 VA — 34 – 60 VA 164 – 631 W 830 – 1580 W 112 – 150 W 40 – 58 W	98 – 475 VA 24 – 50 VA — 67 – 432 VA 76 – 110 VA — 19 – 42 VA 145 – 610 W 67 – 102 W 121 – 150 W 46 – 55 W	612 VA 403 – 666 VA — 396 – 1896 VA 1596 – 2156 VA — 230 – 384 VA 396 W 341 – 528 W 264 – 350 W 374 – 475 W
Maximum Load Duration	Interrupts Automatically				
Maximum Opening Time	50 ms	50 ms	50 ms	62 ms	62 ms
Moulded Case Switch (with High Magnetic Trip)					
Unfused kAIC at 480 Vac (415 Vac) Self-Protected, Will Trip Above: 	65 (70) 1250 for GE125; 1600 for GE160	65 (70) 2500	65 (70) 4000/6300	65 (70) 12,500	65 (70) 20,000

dc Switching Duty

The GE- to GL-Frame circuit breakers are also suitable for switching dc currents.

The GN- and GR-Frame circuit breakers are not suitable for dc currents due to the solid-state overcurrent release system.

For switching dc currents, however, the maximum permissible dc voltage per conducting path has to be considered.

For voltages higher than 250 volts, the series connection of two or three conducting paths is required.

As the current has to flow through all conducting paths so as to maintain the thermal tripping characteristics, the following circuit arrangements are recommended. With dc, the trip values of the instantaneous short circuit release (“n” release) are increased by 30 to 40%.

Table 4. For 3- and 4-Pole Circuit Breakers

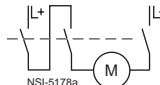
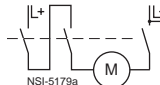
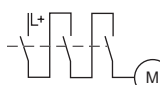
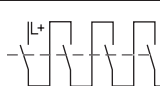
Proposed Circuit	Maximum Permissible Vdc U _e	Remarks
 <p>NSI-5178a</p>	250 Vdc	Double-pole switching. If there is no risk of an earth fault, or if any earth fault which occurs is immediately eliminated (earth fault monitoring), the maximum permissible dc voltage can be 600 volts.
 <p>NSI-5179a</p>	440 Vdc	Double-pole switching (earth system). The earthed pole must always be assigned to the individual conducting path, so that two paths are always in series in the event of an earth fault.
 <p>NSI-5180</p>	600 Vdc	Single-pole switching (earthed system). Three conducting paths in series. The earthed pole must be assigned to the nonswitched conducting path.
 <p>NSI-5181</p>	750 Vdc	Single-pole switching (earthed system). Four conducting paths in series. The earthed pole must be assigned to the nonswitched conducting path.

Multi-Function Electronic Trip Units for All Applications

Digitrip RMS Trip Units

True rms Sensing

Digitrip RMS Trip Units utilize our patented microprocessor-based intelligence to provide true rms sensing, permitting increased accuracy and reliable system protection. True rms sensing is not susceptible to nuisance tripping when waveforms containing high harmonic currents are present.

Digitrip RMS 310

Digitrip RMS 310 Electronic Trip Units are available with Cutler-Hammer Circuit Breakers J-, L-, N- and R-Frames 20 through 2500 amperes. Digitrip RMS 310 Trip Units are available in four styles with either fixed or adjustable rating plugs which establishes the continuous ampere rating of the breaker.

Note: GJ- and GL-Frames have selectable long time delay (t_{LD}) and pickup settings (I_p). A rating plug is not required.

Rating Plugs

If rating plugs are needed, they are marked for 50/60 Hz applications. Both fixed and adjustable rating plugs are available, providing further flexibility when applied to selectively coordinated systems.

Note: Digitrip RMS rating plugs are not interchangeable with Seltronic™ rating plugs.

Curve Shaping

When selectively coordinated systems are called for, Digitrip RMS 310 will provide a cost-effective solution for a variety of applications.

The standard Digitrip RMS 310 includes an adjustable short time pickup setting encompassing an I^2t ramp function which provides the basic LS curve shaping function. GJ- and GL-Frames have an adjustable long time delay.

Note: GJ- and GL-Frames have selectable long time delay (t_{LD}) and pickup settings (I_p). A rating plug is not required.

The optional Digitrip RMS 310 provides additional flat response short time delay adjustments on an instantaneous setting to provide LSI curve shaping capability.

Digitrip RMS 310 Trip Units are available with ground fault pickup and flat response ground fault delay which provides the trip unit with full function LSG and LSG curve shaping flexibility.

Note: Contact factory for availability of ground fault for GL-Frame trip unit.

Digitrip RMS 310 Trip Units can effectively coordinate with both sophisticated upstream power breakers as well as downstream thermal magnetic breakers...making Digitrip RMS 310 Trip Units the cost-effective reliable choice for selectively coordinated systems.

Thermal Memory

All Digitrip RMS Trip Units incorporate a long delay. Thermal memory prevents the system from cumulative overheating due to repeated overcurrent events that may occur in quick succession.

Field Testing

A field test kit is available for Digitrip RMS 310 trip units.

Digitrip RMS 610 and 910



RMS 610



RMS 910

Digitrip RMS 610 and 910 Trip Units are available with Cutler-Hammer R-Frame Circuit Breakers 800 through 2500 amperes. Digitrip 610 and 910 Trip Units provide unparalleled system protection with the added convenience of a local display.

Curve Shaping

Digitrip RMS 610 and 910 Trip Units are available with up to nine curve shaping choices achieved by adjusting up to seven switches on the front of the unit for optimum system coordination. Maximum curve shaping flexibility is provided by dependent long and short delay adjustments that are long delay pickup (I_p) based, depicted on the front of the unit by the blue portion of the time-current curve.

Additional coordination capability can be provided by utilizing the short delay and ground fault zone selective interlocking features available on these trip units.

System Diagnostics

Digitrip RMS 610 and 910 models of trip units provide long delay, short delay, instantaneous, and ground fault cause of trip LEDs on the front of the unit. Their display shows a magnitude of trip information, as well as remote signal contacts, for improved system alarming.

System Monitoring

Digitrip 610 and 910 Trip Units have the capability to monitor phase currents, as well as neutral or ground currents. This information is displayed on a large digital display mounted on the unit.

Digitrip RMS 910 Trip Units can also provide the user with power and energy monitoring capability. Peak power demand, present power demand, and total energy, as well as forward and reverse energy can be monitored with this unit.

Digitrip RMS 910 Trip Units have the additional capability of monitoring line-to-line voltage, as well as system power factor. Both parameters are displayed in the digital display window and are supported by LEDs to indicate which parameter is being displayed.

Harmonics Monitoring

Digitrip RMS 910 Trip Units are capable of displaying values of current harmonics in the digital display window. Percentage of harmonic content can be monitored for each phase, up to the 27th harmonic. Additionally, a total harmonic distortion value can be calculated and displayed.

Communications



Digitrip RMS 910 units have built-in communications options to allow all protection, monitoring, and control information to be transmitted back to a central location via the Cutler-Hammer PowerNet™ system.

Field Testing

Integral field testing capability is provided on all 610 and 910 Trip Units. No additional test set is needed to perform both trip and no trip field testing.

Digitrip RMS Electronic Trip Unit Selection Guide

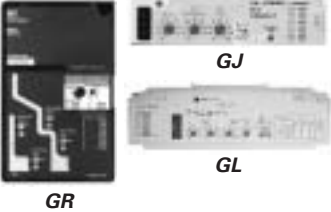
Table 5. Digitrip RMS Electronic Trip Unit Selection Guide

Digitrip	RMS 310	RMS 610	RMS 910
	 <p style="text-align: center;">GJ GL GR</p>		

Breaker Type

Cutler-Hammer Frame(s)	GJ-, GL-, GN- and GR-Frames	GR-Frame	GR-Frame
Ampere Rating	20 – 2500 A	800 – 2500 A	800 – 2500 A
Interrupting Rating at 415 V	35, 70, 100 kA	70, 100 kA	70, 100 kA

Trip Unit Sensing

rms Sensing	Yes	Yes	Yes
-------------	-----	-----	-----

Protection and Coordination

Protection	Ordering Options	LS, LSG	LSI, LSIG	LI, LS, LSI, LIG, LSG, LSIG	LI, LS, LSI, LIG, LSG, LSIG
	Fixed Rating Plug (I_N) ^①	Yes	Yes	Yes	Yes
	Overtemperature Trip	Yes	Yes	Yes	Yes
	Adjustable Rating Plug (I_N) ^①	Yes	Yes	No	No
Long Delay	Long Delay Setting	0.5 – 1.0 (I_N) ^②	0.5 – 1.0 (I_N) ^②	0.5 – 1.0 x (I_N)	0.5 – 1.0 x (I_N)
	Long Delay Time I^2t at 6x	10 Seconds ^②	10 Seconds ^②	2 – 24 Seconds	2 – 24 Seconds
	Long Delay Thermal Memory	Yes	Yes	Yes	Yes
	High Load Alarm	No	No	0.85 x I_r	0.85 x I_r
Short Delay	Short Delay Setting	200 – 800% x (I_N) ^③	200 – 800% x (I_N) ^③	200 – 600% S1 & S2 x (I_r)	200 – 600% S1 & S2 x (I_r)
	Short Delay Time I^2t	100 ms	No	100, 300, 500 ms	100, 300, 500 ms
	Short Delay Time Flat	No	1 – 300 ms	100 – 500 ms	100 – 500 ms
	Short Delay Time ZSI	No	No	Yes	Yes
Instantaneous	Instantaneous Setting	No	200 – 800% x (I_N) ^④	200 – 600% M1 & M2 x (I_N)	200 – 600% M1 & M2 x (I_N)
	Discriminator	No	No	Yes ^⑤	Yes ^⑤
	Instantaneous Override	Yes	Yes	Yes	Yes
Ground Fault	Ground Fault Setting	Var/Frame ^⑥	Var/Frame ^⑥	25 – 100% x (I_N) ^⑥	25 – 100% x (I_N) ^⑥
	Ground Fault Delay I^2t at .62x	No	No	100, 300, 500 ms	100, 300, 500 ms
	Ground Fault Delay Flat	1 – 500 ms ^⑦	1 – 500 ms ^⑦	100 – 500 ms	100 – 500 ms
	Ground Fault ZSI	No	No	Yes	Yes
	Ground Fault Thermal Memory	No	No	Yes	Yes

System Diagnostics

Cause of Trip LEDs	No	No	Yes	Yes
Magnitude of Trip Information	No	No	Yes	Yes
Remote Signal Contacts	No	No	Yes	Yes

System Monitoring

Digital Display	No	No	Yes	Yes
Current	No	No	Yes	Yes
Voltage	No	No	No	Yes
Power and Energy	No	No	No	Yes
Power Quality — Harmonics	No	No	No	Yes
Power Factor	No	No	No	Yes

System Communications

PowerNet	No	No	No	Yes
----------	----	----	----	-----

Field Testing

Testing Method	Test Set	Test Set	Integral	Integral
----------------	----------	----------	----------	----------

① GJ- and GL-Frames have selectable settings instead of a rating plug.

② GJ- and GL-Frames have adjustable long delay times of 2 – 24 seconds.

③ 2500 ampere GR-Frame 200 – 600% x (I_N).

④ GJ-Frame also has a 14X setting.

⑤ LS, LSG only.

⑥ Not to exceed 1200 amperes.

⑦ GJ- and GL-Frames are Instantaneous, 120 ms. GN- and GR-Frames are Instantaneous, 100, 300 and 500 ms.

Note: I_N = Rating plug rating.
 I_r = Long delay setting.

GE-Frame, 160 Amperes — Selection Guide and Ordering Information



GE Frame

Table 6. UL 489/IEC 60947-2 Interrupting Capacity Ratings

Circuit Breaker Type	Number of Poles	Interrupting Capacity (Symmetrical Amperes) (kA)										Volts dc ①			
		Volts ac (50/60 Hz)										125		250 ②③	
		120	220 – 240		277	347		380 – 415		480	600Y/347	I _{cu}	I _{cs}	I _{cu}	I _{cs}
	I _{cu}	I _{cs}		I _{cu}	I _{cs}	I _{cu}	I _{cs}				I _{cu}	I _{cs}	I _{cu}	I _{cs}	
GEB	1 2, 3, 4	35 —	25 25	25 25	18 —	— —	— —	— —	— —	— —	— —	10 —	10 —	— 10	— 10
GEE	2, 3, 4	—	35	35	—	—	—	25	25	25	18	—	—	10	10
GES	1 2, 3, 4	100 —	85 85	43 43	35 —	22 —	— —	— 40	— 30	— 35	22 22	35 —	35 —	— 35	— 35
GEH	1 2, 3, 4	200 —	100 100	50 50	65 —	25 —	— —	— 70	— 35	— 65	25 25	42 —	42 —	— 42	— 42

- ① dc ratings apply to substantially non-inductive circuits.
 - ② 2-pole circuit breaker, or two poles of 3-pole circuit breaker.
 - ③ Time constant is 3 milliseconds minimum at 10 kA and 8 milliseconds minimum at 42 kA.
- Note:** Contact Eaton for availability of E125 frame breakers in panelboards and switchboards.

Table 7. Complete Circuit Breaker ④ — Includes Frame, Trip Unit, End Caps and Metric Mounting Hardware ⑤

Maximum Continuous Ampere Rating at 40°C ⑦	1-Pole		2-Pole		3-Pole ④		4-Pole ⑥				
	Fixed Thermal	Fixed Magnetic ⑦	Fixed Thermal	Fixed Magnetic ⑦	Fixed Thermal	Fixed Magnetic ⑦	Adjustable Thermal	Thermal	Fixed Thermal	Adjustable Thermal	Thermal
							Fixed Magnetic ⑦	Range	Fixed Magnetic	Fixed Magnetic ⑦	Range
IC Rating: 25 kAIC at 240 Vac			IC Rating: 18 kAIC at 415 and 480 Vac								
15	GEB1015FFG	—	GEB2015FFG	—	GEB3015FFM	—	—	—	GEB7015FFM	—	—
16	GEB1016FFG	—	GEB2016FFG	—	GEB3016FFM	—	—	—	GEB7016FFM	—	—
20	GEB1020FFG	—	GEB2020FFG	—	GEB3020FFM	GEB3020AFM	16 – 20	—	GEB7020FFM	GEB7020AFM	16 – 20
25	GEB1025FFG	—	GEB2025FFG	—	GEB3025FFM	GEB3025AFM	20 – 25	—	GEB7025FFM	GEB7025AFM	20 – 25
30	GEB1030FFG	—	GEB2030FFG	—	GEB3030FFM	—	—	—	GEB7030FFM	—	—
32	GEB1032FFG	—	GEB2032FFG	—	GEB3032FFM	GEB3032AFM	25 – 32	—	GEB7032FFM	GEB7032AFM	25 – 32
35	GEB1035FFG	—	GEB2035FFG	—	GEB3035FFM	—	—	—	GEB7035FFM	—	—
40	GEB1040FFG	—	GEB2040FFG	—	GEB3040FFM	GEB3040AFM	32 – 40	—	GEB7040FFM	GEB7040AFM	32 – 40
45	GEB1045FFG	—	GEB2045FFG	—	GEB3045FFM	—	—	—	GEB7045FFM	—	—
50	GEB1050FFG	—	GEB2050FFG	—	GEB3050FFM	GEB3050AFM	40 – 50	—	GEB7050FFM	GEB7050AFM	40 – 50
60	GEB1060FFG	—	GEB2060FFG	—	GEB3060FFM	—	—	—	GEB7060FFM	—	—
63	GEB1063FFG	—	GEB2063FFG	—	GEB3063FFM	GEB3063AFM	50 – 63	—	GEB7063FFM	GEB7063AFM	50 – 63
70	GEB1070FFG	—	GEB2070FFG	—	GEB3070FFM	—	—	—	GEB7070FFM	—	—
80	GEB1080FFG	—	GEB2080FFG	—	GEB3080FFM	GEB3080AFM	63 – 80	—	GEB7080FFM	GEB7080AFM	63 – 80
90	GEB1090FFG	—	GEB2090FFG	—	GEB3090FFM	—	—	—	GEB7090FFM	—	—
100	GEB1100FFG	—	GEB2100FFG	—	GEB3100FFM	GEB3100AFM	80 – 100	—	GEB7100FFM	GEB7100AFM	80 – 100
125	GEB1125FFG	—	GEB2125FFG	—	GEB3125FFM	GEB3125AFM	100 – 125	—	GEB7125FFM	GEB7125AFM	100 – 125
160	—	—	—	—	GEB3160FFM	GEB3160AFM	125 – 160	—	GEB7160FFM	GEB7160AFM	125 – 160
IC Rating: 35 kAIC at 240 Vac			IC Rating: 25 kAIC at 415 and 480 Vac								
15	—	—	GEE2015FFG	—	GEE3015FFM	—	—	—	GEE7015FFM	—	—
16	—	—	GEE2016FFG	—	GEE3016FFM	—	—	—	GEE7016FFM	—	—
20	—	—	GEE2020FFG	—	GEE3020FFM	GEE3020AFM	16 – 20	—	GEE7020FFM	GEE7020AFM	16 – 20
25	—	—	GEE2025FFG	—	GEE3025FFM	GEE3025AFM	20 – 25	—	GEE7025FFM	GEE7025AFM	20 – 25
30	—	—	GEE2030FFG	—	GEE3030FFM	—	—	—	GEE7030FFM	—	—
32	—	—	GEE2032FFG	—	GEE3032FFM	GEE3032AFM	25 – 32	—	GEE7032FFM	GEE7032AFM	25 – 32
35	—	—	GEE2035FFG	—	GEE3035FFM	—	—	—	GEE7035FFM	—	—
40	—	—	GEE2040FFG	—	GEE3040FFM	GEE3040AFM	32 – 40	—	GEE7040FFM	GEE7040AFM	32 – 40
45	—	—	GEE2045FFG	—	GEE3045FFM	—	—	—	GEE7045FFM	—	—
50	—	—	GEE2050FFG	—	GEE3050FFM	GEE3050AFM	40 – 50	—	GEE7050FFM	GEE7050AFM	40 – 50
60	—	—	GEE2060FFG	—	GEE3060FFM	—	—	—	GEE7060FFM	—	—
63	—	—	GEE2063FFG	—	GEE3063FFM	GEE3063AFM	50 – 63	—	GEE7063FFM	GEE7063AFM	50 – 63
70	—	—	GEE2070FFG	—	GEE3070FFM	—	—	—	GEE7070FFM	—	—
80	—	—	GEE2080FFG	—	GEE3080FFM	GEE3080AFM	63 – 80	—	GEE7080FFM	GEE7080AFM	63 – 80
90	—	—	GEE2090FFG	—	GEE3090FFM	—	—	—	GEE7090FFM	—	—
100	—	—	GEE2100FFG	—	GEE3100FFM	GEE3100AFM	80 – 100	—	GEE7100FFM	GEE7100AFM	80 – 100
125	—	—	GEE2125FFG	—	GEE3125FFM	GEE3125AFM	100 – 125	—	GEE7125FFM	GEE7125AFM	100 – 125
160	—	—	—	—	GEE3160FFM	GEE3160AFM	125 – 160	—	GEE7160FFM	GEE7160AFM	125 – 160

- ④ Replace suffix “M” or “G” with “W” for no line and load terminals. Replace suffix M with G for standard cable terminals included.
- ⑤ 1- and 2-pole breakers include standard terminals.
- ⑥ Neutral protection is indicated by the fourth character: 4=0%, 7=100%.
- ⑦ 16, 32, 63, 160 amperes are not NEMA rated. Maximum NEMA rating for GE is 125 amperes. Adjustable thermal trip units are typically used in IEC markets and are not NEMA rated.

Frame Size GE, 160 Amperes (125 Amperes NEMA)

Table 7. Complete Circuit Breaker ^① — Includes Frame, Trip Unit, End Caps and Metric Mounting Hardware (Continued) ^②

Maximum Continuous Ampere Rating at 40°C ^④	1-Pole		2-Pole		3-Pole ^①		4-Pole ^③		
	Fixed Thermal Fixed Magnetic ^④	Fixed Thermal Fixed Magnetic ^④	Fixed Thermal Fixed Magnetic ^④	Fixed Thermal Fixed Magnetic ^④	Adjustable Thermal Fixed Magnetic ^④	Thermal Range	Fixed Thermal Fixed Magnetic ^④	Adjustable Thermal Fixed Magnetic ^④	Thermal Range
IC Rating: 85 kAIC at 240 Vac			IC Rating: 40 kAIC at 415 Vac, 35 kAIC at 480 Vac						
15	GES1015FFG	GES2015FFG	GES3015FFM	—	—	—	GES7015FFM	—	—
16	GES1016FFG	GES2016FFG	GES3016FFM	—	—	—	GES7016FFM	—	—
20	GES1020FFG	GES2020FFG	GES3020FFM	GES3020AFM	16 – 20	GES7020FFM	GES7020AFM	16 – 20	16 – 20
25	GES1025FFG	GES2025FFG	GES3025FFM	GES3025AFM	20 – 25	GES7025FFM	GES7025AFM	20 – 25	20 – 25
30	GES1030FFG	GES2030FFG	GES3030FFM	—	—	GES7030FFM	—	—	—
32	GES1032FFG	GES2032FFG	GES3032FFM	GES3032AFM	25 – 32	GES7032FFM	GES7032AFM	25 – 32	25 – 32
35	GES1035FFG	GES2035FFG	GES3035FFM	—	—	GES7035FFM	—	—	—
40	GES1040FFG	GES2040FFG	GES3040FFM	GES3040AFM	32 – 40	GES7040FFM	GES7040AFM	32 – 40	32 – 40
45	GES1045FFG	GES2045FFG	GES3045FFM	—	—	GES7045FFM	—	—	—
50	GES1050FFG	GES2050FFG	GES3050FFM	GES3050AFM	40 – 50	GES7050FFM	GES7050AFM	40 – 50	40 – 50
60	GES1060FFG	GES2060FFG	GES3060FFM	—	—	GES7060FFM	—	—	—
63	GES1063FFG	GES2063FFG	GES3063FFM	GES3063AFM	50 – 63	GES7063FFM	GES7063AFM	50 – 63	50 – 63
70	GES1070FFG	GES2070FFG	GES3070FFM	—	—	GES7070FFM	—	—	—
80	GES1080FFG	GES2080FFG	GES3080FFM	GES3080AFM	63 – 80	GES7080FFM	GES7080AFM	63 – 80	63 – 80
90	GES1090FFG	GES2090FFG	GES3090FFM	—	—	GES7090FFM	—	—	—
100	GES1100FFG	GES2100FFG	GES3100FFM	GES3100AFM	80 – 100	GES7100FFM	GES7100AFM	80 – 100	80 – 100
125	GES1125FFG	GES2125FFG	GES3125FFM	GES3125AFM	100 – 125	GES7125FFM	GES7125AFM	100 – 125	100 – 125
IC Rating: 100 kAIC at 240 Vac			IC Rating: 70 kAIC at 415 Vac, 65 kAIC at 480 Vac						
15	GEH1015FFG	GEH2015FFG	GEH3015FFM	—	—	GEH7015FFM	—	—	—
16	GEH1016FFG	GEH2016FFG	GEH3016FFM	—	—	GEH7016FFM	—	—	—
20	GEH1020FFG	GEH2020FFG	GEH3020FFM	GEH3020AFM	16 – 20	GEH7020FFM	GEH7020AFM	16 – 20	16 – 20
25	GEH1025FFG	GEH2025FFG	GEH3025FFM	GEH3025AFM	20 – 25	GEH7025FFM	GEH7025AFM	20 – 25	20 – 25
30	GEH1030FFG	GEH2030FFG	GEH3030FFM	—	—	GEH7030FFM	—	—	—
32	GEH1032FFG	GEH2032FFG	GEH3032FFM	GEH3032AFM	25 – 32	GEH7032FFM	GEH7032AFM	25 – 32	25 – 32
35	GEH1035FFG	GEH2035FFG	GEH3035FFM	—	—	GEH7035FFM	—	—	—
40	GEH1040FFG	GEH2040FFG	GEH3040FFM	GEH3040AFM	32 – 40	GEH7040FFM	GEH7040AFM	32 – 40	32 – 40
45	GEH1045FFG	GEH2045FFG	GEH3045FFM	—	—	GEH7045FFM	—	—	—
50	GEH1050FFG	GEH2050FFG	GEH3050FFM	GEH3050AFM	40 – 50	GEH7050FFM	GEH7050AFM	40 – 50	40 – 50
60	GEH1060FFG	GEH2060FFG	GEH3060FFM	—	—	GEH7060FFM	—	—	—
63	GEH1063FFG	GEH2063FFG	GEH3063FFM	GEH3063AFM	50 – 63	GEH7063FFM	GEH7063AFM	50 – 63	50 – 63
70	GEH1070FFG	GEH2070FFG	GEH3070FFM	—	—	GEH7070FFM	—	—	—
80	GEH1080FFG	GEH2080FFG	GEH3080FFM	GEH3080AFM	63 – 80	GEH7080FFM	GEH7080AFM	63 – 80	63 – 80
90	GEH1090FFG	GEH2090FFG	GEH3090FFM	—	—	GEH7090FFM	—	—	—
100	GEH1100FFG	GEH2100FFG	GEH3100FFM	GEH3100AFM	80 – 100	GEH7100FFM	GEH7100AFM	80 – 100	80 – 100
125	GEH1125FFG	GEH2125FFG	GEH3125FFM	GEH3125AFM	100 – 125	GEH7125FFM	GEH7125AFM	100 – 125	100 – 125

^① Replace suffix "M" or "G" with "W" for no line and load terminals. Replace suffix M with G for standard cable terminals included.

^② 1- and 2-pole breakers include standard terminals.

^③ Neutral protection is indicated by the fourth character: 4 = 0%, 7 = 100%.

^④ 16, 32, 63, 160 amperes are not NEMA rated. Maximum NEMA rating for GE is 125 amperes. Adjustable thermal trip units are typically used in IEC markets and are not NEMA rated.

Table 8. Moulded Case Switches

Ampere Rating	Number of Poles	Catalogue Number
125	3	GEK3125KSM
160	3	GEK3160KSM ^⑤

^⑤ 16, 32, 63, 160 amperes are not NEMA rated. Maximum NEMA rating for GE is 125 amperes. Adjustable thermal trip units are typically used in IEC markets and are not NEMA rated.

Line and Load Terminals

GE-Frame circuit breakers and Moulded case switches have 3T125EF line and load terminals as standard equipment.

Table 9. Line and Load Terminals

Maximum Breaker Amperes	Terminal Body Material	Wire Type	Metric Wire Range mm ²	AWG Wire Range	Catalogue Number Package of 3 Terminals
Standard Cu/Al Pressure Type Terminals					
125	Steel	Cu/Al	2.5-95	#14-3/0	3T125EF ①
125	Aluminum	Cu/Al	2.5-50	#14-1/0	3TA125EF
125	Aluminum	Cu/Al	16-95	#6-3/0	3TA150EF
160	Aluminum	Cu/Al	35-120	#3-250	3TA160EFK ②
160	Aluminum	Cu/Al	35-120	#3-250	4TA160EFK ③

① Standard line and load terminals included with GE-Frame MCCBs.

② 3 terminals with terminal shield.

③ 4 terminals with terminal shield.

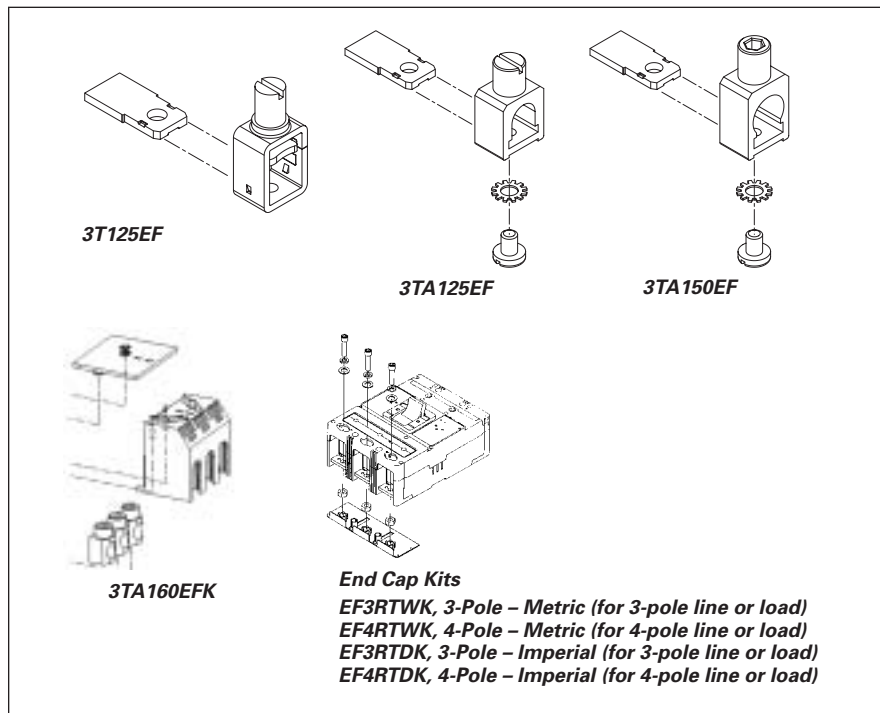

Figure 3. Line and Load Terminals, and End Cap Kits

Insert collar enclosing conductor as shown in **Figure 3**. Locate nut on top of conductor and tighten securely with screw and washer.

Caution: Collar must surround conductor.

Insert collar enclosing conductor and center on extrusion. Tighten securely with screw and washer.

End cap kits are used on the E-Frame breaker line side to connect bus bar or similar electrical connections. Includes hardware.

Control Wire Terminal Kit

For use with steel or stainless steel terminals only.

Note: Standard line and load terminals included with GE-Frame MCCBs.

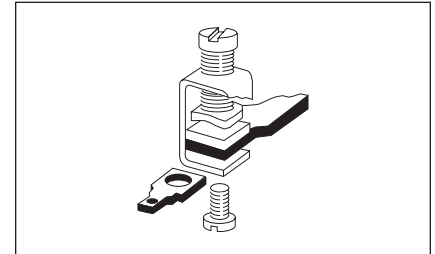

Figure 4. Control Wire Terminal Kit

Table 10. Control Wire Terminal Kit

Description	Catalogue Number
Package of 12 (Priced Individually)	GCWTK

Interphase Barriers

The interphase barrier is available for extended insulation between circuit breaker poles. Specify quantity when ordering.

Table 11. Interphase Barriers

Description	Catalogue Number
Package of 2	EIPBK

Base Mounting Hardware

Metric base mounting hardware is included with a circuit breaker or Moulded case switch. A DIN rail adapter is available.

Note: English mounting hardware kit can be supplied: Catalogue Number **BMHE**.

Table 12. Base Mounting Hardware

DIN Rail Adapter	Catalogue Number
3- or 4-Pole	EF34DIN

Frame Size GE, 160 Amperes (125 Amperes NEMA)

Multiwire Connectors

Field-installed multiwire connectors for the load side (OFF) end terminals. They are used to distribute the load from the circuit breaker to multiple devices without the use of separate distribution terminal blocks.

Multiwire lug kits include mounting hardware, insulators and tin-plated aluminum connectors to replace three mechanical load lugs. UL listed for copper only as used on the load side (OFF) end.

Table 13. GE-Frame Multiwire Connectors Ordering Information (Package of 3)

Maximum Amperes	Wires per Terminal	Wire Size Range AWG Cu	Kit Catalogue Number
125	3	14 – 2	3TA100E3K
125	6	14 – 6	3TA100E6K

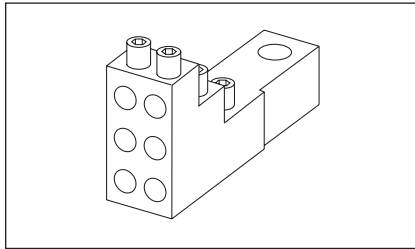

Figure 5. Multiwire Connectors

Terminal Shields

The terminal shield is available for line terminal areas in 2-, 3- and 4-pole circuit breakers. The standard style number by pole for each terminal shield is for a package of 2 and is priced per each package.

Table 14. Terminal Shields

Number of Poles	Standard Package of 2	IP30 Protection
1P (Load end)	EFTS1KA	
1P (Line end)	EFTS1KB	
2	EFTS2K	
3	EFTS3K	
4	EFTS4K	

Terminal End Covers (Gas Barrier)

The terminal end cover is available for 3-pole circuit breakers only. Two conductor opening sizes are available. Specify quantity (one per circuit breaker) when ordering.

Table 15. Terminal End Covers (Gas Barrier)

Conductor Opening Diameter — mm (Inches)	Catalogue Number
6.4 (0.25)	EEC3K
10.4 (0.41)	EEC4K

Terminal Extensions

Table 16. Terminal Extensions

Number of Poles	Catalogue Number
3	EFTES3
4	EFTES4

Terminal Spreaders

Table 17. Terminal Spreaders

Number of Poles	Catalogue Number
3	EFTEW3
4	EFTEW4

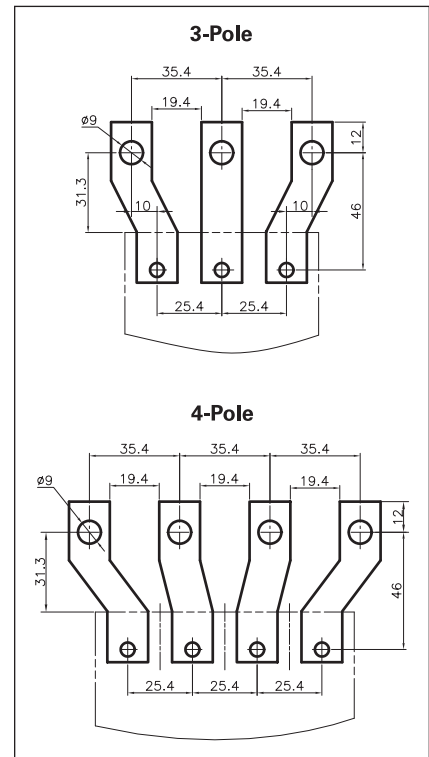
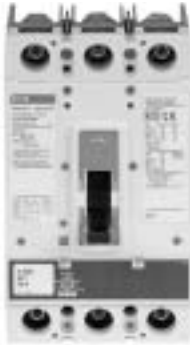

Figure 6. Terminal Spreaders

GJ-Frame, 250 Amperes — Selection Guide and Ordering Information



GJ Frame

Table 18. UL 489/IEC 60947-2 Interrupting Capacity Ratings

Circuit Breaker Type	Number of Poles	Interrupting Capacity (kA Symmetrical Amperes)									
		Volts ac (50/60 Hz)								Volts dc ①	
		220 – 240		380 – 415		480	600	690		250 ②③	
		I _{cu}	I _{cs}	I _{cu}	I _{cs}			I _{cu}	I _{cs}	I _{cu}	I _{cs}
GJE	2, 3, 4	65	65	25	25	25	18	12	6	10	10
GJS	2, 3, 4	85	85	40	40	35	18	12	6	22	22
GJH	2, 3, 4	100	100	70	70	65	25	14	7	22	22
GJC	2, 3, 4	200	150	100	75	100	50	20	10	42	42

① dc ratings apply to substantially non-inductive circuits.
 ② 2-pole circuit breaker, or two poles of 3-pole circuit breaker.
 ③ Time constant is 3 milliseconds minimum at 10 kA and 8 milliseconds minimum at 22 kA.
Note: Contact Eaton for availability of J250 frame breakers in panelboards and switchboards.

Table 19. Complete Circuit Breaker with Thermal-Magnetic Trip Unit — Includes Frame, Thermal-Magnetic Trip Units, End Caps and Metric Mounting Hardware ④⑤

Maximum Continuous Ampere Rating at 40°C	Magnetic Range	2-Pole		3-Pole		4-Pole ⑥		
		Fixed Thermal Adjustable Magnetic	Fixed Thermal Adjustable Magnetic	Adjustable Thermal Adjustable Magnetic ⑦	Thermal Range	Fixed Thermal Adjustable Magnetic	Adjustable Thermal Adjustable Magnetic ⑦	Thermal Range

IC Rating: 25 kAIC at 415 and 480 Vac

70	350 – 700	GJE2070FAG	GJE3070FAM	—	—	GJE4070FAM	—	—
80	400 – 800	—	—	GJE3080AAM	64 – 80	—	GJE4080AAM	—
90	450 – 900	GJE2080FAG	GJE3080FAM	—	—	GJE4080FAM	—	—
100	500 – 1000	GJE2100FAG	GJE3100FAM	GJE3100AAM	80 – 100	GJE4100FAM	GJE4100AAM	80 – 100
125	625 – 1250	GJE2125FAG	GJE3125FAM	GJE3125AAM	100 – 125	GJE4125FAM	GJE4125AAM	100 – 125
150	750 – 1500	GJE2150FAG	GJE3150FAM	—	—	GJE4150FAM	—	—
160	800 – 1600	—	—	GJE3160AAM	128 – 160	—	GJE4160AAM	128 – 160
175	875 – 1750	GJE2175FAG	GJE3175FAM	—	—	GJE4175FAM	—	—
200	1000 – 2000	GJE2200FAG	GJE3200FAM	GJE3200AAM	160 – 200	GJE4200FAM	GJE4200AAM	160 – 200
225	1125 – 2250	GJE2225FAG	GJE3225FAM	—	—	GJE4225FAM	—	—
250	1250 – 2500	GJE2250FAG	GJE3250FAM	GJE3250AAM	200 – 250	GJE4250FAM	GJE4250AAM	200 – 250

IC Rating: 40 kAIC at 415 Vac, 35 kAIC at 480 Vac

70	350 – 700	GJS2070FAG	GJS3070FAM	—	—	GJS4070FAM	—	—
80	400 – 800	—	—	GJS3080AAM	64 – 80	—	GJS4080AAM	—
90	450 – 900	GJS2090FAG	GJS3090FAM	—	64 – 80	GJS4090FAM	—	—
100	500 – 1000	GJS2100FAG	GJS3100FAM	GJS3100AAM	80 – 100	GJS4100FAM	GJS4100AAM	80 – 100
125	625 – 1250	GJS2125FAG	GJS3125FAM	GJS3125AAM	100 – 125	GJS4125FAM	GJS4125AAM	100 – 125
150	750 – 1500	GJS2150FAG	GJS3150FAM	—	—	GJS4150FAM	—	—
160	800 – 1600	—	—	GJS3160AAM	128 – 160	—	GJS4160AAM	128 – 160
175	875 – 750	GJS2175FAG	GJS3175FAM	—	—	GJS4175FAM	—	—
200	1000 – 2000	GJS2200FAG	GJS3200FAM	GJS3200AAM	160 – 200	GJS4200FAM	GJS4200AAM	160 – 200
225	1125 – 2250	GJS2225FAG	GJS3225FAM	—	—	GJS4225FAM	—	—
250	1250 – 2500	GJS2250FAG	GJS3250FAM	GJS3250AAM	200 – 250	GJS4250FAM	GJS4250AAM	200 – 250

IC Rating: 70 kAIC at 415 Vac, 65 kAIC at 480 Vac

70	350 – 700	GJH2070FAG	GJH3070FAM	—	—	GJH4070FAM	—	—
80	400 – 800	—	—	GJH3080AAM	64 – 80	—	GJH4080AAM	—
90	450 – 900	GJH2090FAG	GJH3090FAM	—	64 – 80	GJH4090FAM	—	—
100	500 – 1000	GJH2100FAG	GJH3100FAM	GJH3100AAM	80 – 100	GJH4100FAM	GJH4100AAM	80 – 100
125	625 – 1250	GJH2125FAG	GJH3125FAM	GJH3125AAM	100 – 125	GJH4125FAM	GJH4125AAM	100 – 125
150	750 – 1500	GJH2150FAG	GJH3150FAM	—	—	GJH4150FAM	—	—
160	800 – 1600	—	—	GJH3160AAM	128 – 160	GJH4160FAM ⑧	GJH4160AAM	128 – 160
175	875 – 1750	GJH2175FAG	GJH3175FAM	—	—	GJH4175FAM	—	—
200	1000 – 2000	GJH2200FAG	GJH3200FAM	GJH3200AAM	160 – 200	GJH4200FAM	GJH4200AAM	160 – 200
225	1125 – 2250	GJH2225FAG	GJH3225FAM	—	—	GJH4225FAM	—	—
250	1250 – 2500	GJH2250FAG	GJH3250FAM	GJH3250AAM	200 – 250	GJH4250FAM	GJH4250AAM	200 – 250

④ Replace suffix “M” or “G” with “W” for no line and load terminals. Replace suffix M with G for standard cable terminals included.
 ⑤ 2-pole includes standard terminals.
 ⑥ Adjustable thermal trip units are typically used in IEC markets and are not NEMA rated.
 ⑦ Neutral protection is indicated by the fourth character: 4 = 0%, 8 = adjustable 0 or 60% and 9 = 0 or 100%. 4-pole ground fault option does not have neutral protection.

Frame Size GJ, 250 Amperes

Table 19. Complete Circuit Breaker with Thermal-Magnetic Trip Unit — Includes Frame, Thermal-Magnetic Trip Units, End Caps and Metric Mounting (Continued) ①②

Maximum Continuous Ampere Rating at 40°C	Magnetic Range	2-Pole		3-Pole		4-Pole ④		
		Fixed Thermal Adjustable Magnetic	Fixed Thermal Adjustable Magnetic	Adjustable Thermal Adjustable Magnetic ③	Thermal Range	Fixed Thermal Adjustable Magnetic	Adjustable Thermal Adjustable Magnetic ③	Thermal Range
IC Rating: Component Frame Only — 25 kAIC at 415 and 480 Vac								
250	—	GJE2250NN	GJE3250NN	—	—	GJE4250NN	—	—
IC Rating: Component Frame Only — 40 kAIC at 415 Vac, 35 kAIC at 480 Vac								
250	—	GJS2250NN	GJS3250NN	—	—	GJS4250NN	—	—
IC Rating: Component Frame Only — 70 kAIC at 415 Vac, 65 kAIC at 480 Vac								
250	—	GJH2250NN	GJH3250NN	—	—	GJH4250NN	—	—
Thermal-Magnetic Trip Unit								
70	350 – 700	JT2070FA	JT3070FA	—	—	JT4070FA	—	—
80	400 – 800	—	—	JT3080AA ③	64 – 100	—	JT4080AA ③	—
90	450 – 900	JT2090FA	JT3090FA	—	—	JT4090FA	—	—
100	500 – 1000	JT2100FA	JT3100FA	JT3100AA ③	80 – 100	JT4100FA	JT4100AA ③	80 – 100
125	625 – 1250	JT2125FA	JT3125FA	JT3125AA ③	100 – 125	JT4125FA	JT4125AA ③	100 – 125
150	750 – 1500	JT2150FA	JT3150FA	—	—	JT4150FA	—	—
160	800 – 1600	JT2160FA ③	—	JT3160AA ③	128 – 160	—	JT4160AA ③	128 – 160
175	875 – 1750	JT2175FA	JT3175FA	—	—	JT4175FA	—	—
200	1000 – 2000	JT2200FA	JT3200FA	JT3200AA ③	160 – 200	JT4200FA	JT4200AA ③	160 – 200
225	1125 – 2250	JT2225FA	JT3225FA	—	—	JT4225FA	—	—
250	1250 – 2500	J2T250FA	JT3250FA	JT3250AA ③	200 – 250	JT4250FA	JT4250AA ③	200 – 250

① Replace suffix "M" or "G" with "W" for no line and load terminals. Replace suffix M with G for standard cable terminals included.

② 2-pole includes standard terminals.

③ Adjustable thermal trip units are typically used in IEC markets and are not NEMA rated.

④ Neutral protection is indicated by the fourth character: 4 = 0%, 8 = adjustable 0 or 60% and 9 = 0 or 100%.

Table 20. Complete GJ Breakers with Electronic Trip Unit ⑤⑥

Ampere Rating	LS	LSI	LSG ⑦	LSIG ⑦	Neutral CT ⑦⑧ for LSG & LSIG
3-Pole ⑨ — IC Rating: 25 kAIC at 415 and 480 Vac					
50	GJE305033M	GJE305032M	GJE305035M	GJE305036M	JGFCT050
100	GJE310033M	GJE310032M	GJE310035M	GJE310036M	JGFCT100
160	GJE316033M	GJE316032M	GJE316035M	GJE316036M	JGFCT160
250	GJE325033M	GJE325032M	GJE325035M	GJE325036M	JGFCT250
4-Pole ⑩ — IC Rating: 25 kAIC at 415 and 480 Vac					
50	GJE405033M	GJE405032M	GJE405035M	GJE405036M	JGFCT050
100	GJE410033M	GJE410032M	GJE410035M	GJE410036M	JGFCT100
160	GJE416033M	GJE416032M	GJE416035M	GJE416036M	JGFCT160
250	GJE425033M	GJE425032M	GJE425035M	GJE425036M	JGFCT250
3-Pole — IC Rating: 40 kAIC at 415 Vac, 35 kAIC at 480 Vac					
50	GJS305033M	GJS305032M	GJS305035M	GJS305036M	JGFCT050
100	GJS310033M	GJS310032M	GJS310035M	GJS310036M	JGFCT100
160	GJS316033M	GJS316032M	GJS316035M	GJS316036M	JGFCT160
250	GJS325033M	GJS325032M	GJS325035M	GJS325036M	JGFCT250
4-Pole ⑩ — IC Rating: 40 kAIC at 415 Vac, 35 kAIC at 480 Vac					
50	GJS405033M	GJS405032M	GJS405035M	GJS405036M	JGFCT050
100	GJS410033M	GJS410032M	GJS410035M	GJS410036M	JGFCT100
160	GJS416033M	GJS416032M	GJS416035M	GJS416036M	JGFCT160
250	GJS425033M	GJS425032M	GJS425035M	GJS425036M	JGFCT250
3-Pole — IC Rating: 70 kAIC at 415 Vac, 65 kAIC at 480 Vac					
50	GJH305033M	GJH305032M	GJH305035M	GJH305036M	JGFCT050
100	GJH310033M	GJH310032M	GJH310035M	GJH310036M	JGFCT100
160	GJH316033M	GJH316032M	GJH316035M	GJH316036M	JGFCT160
250	GJH325033M	GJH325032M	GJH325035M	GJH325036M	JGFCT250
4-Pole ⑩ — IC Rating: 70 kAIC at 415 Vac, 65 kAIC at 480 Vac					
50	GJH405033M	GJH405032M	GJH405035M	GJH405036M	JGFCT050
100	GJH410033M	GJH410032M	GJH410035M	GJH410036M	JGFCT100
160	GJH416033M	GJH416032M	GJH416035M	GJH416036M	JGFCT160
250	GJH425033M	GJH425032M	GJH425035M	GJH425036M	JGFCT250

⑤ Replace suffix "M" or "G" with "W" for no line and load terminals. Replace suffix M with G for standard cable terminals included.

⑥ For ac use only.

⑦ Neutral CT for LSG and LSIG applied to 4-wire applications must be ordered as a separate item.

⑧ Required for 4-wire systems if neutral protection is desired.

⑨ For 2-pole applications, use two outer poles.

⑩ Neutral protection 4 = 0%, 6 = 60%, 7 = 100% electronic trip unit neutral protection is not adjustable. 4-pole ground fault option does not have neutral protection.

Table 21. GJ Electronic Trip Units

Ampere Rating	LS	LSI	LSG	LSIG	Neutral CT ^① for LSG & LSIG
3-Pole					
50	JT305033	JT305032	JT305035	JT305036	JGFCT050
100	JT310033	JT310032	JT310035	JT310036	JGFCT100
160	JT316033	JT316032	JT316035	JT316036	JGFCT160
250	JT325033	JT325032	JT325035	JT325036	JGFCT250
4-Pole ^②					
50	JT405033	JT405032	JT405035	JT405036	JGFCT050
100	JT410033	JT410032	JT410035	JT410036	JGFCT100
160	JT416033	JT416032	JT416035	JT416036	JGFCT160
250	JT425033	JT425032	JT425035	JT425036	JGFCT250

^① Required for 4-wire systems if neutral protection is desired.

^② Neutral protection 4 = 0%, 6 = 60%, 7 = 100% electronic trip unit neutral protection is not adjustable.

Note: Long time pickup — no rating plug.

250 Ampere Settings — 250, 225, 200, 175, 160, 150, 125, 100.

160 Ampere Settings — 160, 150, 125, 110, 100, 90, 80, 63.

100 Ampere Settings — 100, 90, 80, 70, 63, 50, 45, 40.

50 Ampere Settings — 50, 45, 40, 32, 30, 25, 20.

Note: Adjustable long time delay — 2 – 24 seconds at 6 x I_r.

Adjustable short time delay — Inst., 120, 300 ms.

Note: Plug-in test kit — Catalogue Numbers **MTST120V** (120 Vac) or **MTST230V** (230 Vac).

**Table 22. Moulded Case Switches ^③
(Includes Line and Load Collars)**

Ampere Rating	Number of Poles	Catalogue Number
250	3	GJK3250KSM
	4	GJK7250KSM ^④

^③ For 2-pole applications, use outer poles of a 3-pole MCS.

^④ 100% neutral protection.



Digitrip 310+ Test Kit



Digitrip 310+ Test Kit Shown with GJ MCCB



GJ Digitrip 310+ Electronic Trip Unit

Frame Size GJ, 250 Amperes

Line and Load Terminals

GJ-Frame circuit breakers include Cu/Al terminals T250FJ as standard. When optional copper only terminals are required, order by catalogue number.

Table 23. Line and Load Terminals

Maximum Breaker Amperes	Terminal Body Material	Wire Type	Metric Wire Range mm ²	AWG Wire Range/Number of Conductors	Catalogue Number
-------------------------	------------------------	-----------	-----------------------------------	-------------------------------------	------------------

Standard Pressure Type Terminals

250	Stainless Steel	Cu	25 – 185	#4 – 350 (1)	T250FJ ①②
250	Aluminum	Cu/Al	25 – 185	#4 – 350 (1)	TA250FJ ①

Optional Copper and Cu/Al Pressure Type Terminals

250	Copper	Cu/Al	25 – 185	#4 – 350 (1)	TC250FJ ①③
-----	--------	-------	----------	--------------	------------

- ① Single terminals individually packed.
- ② Standard line and load terminals.
- ③ Contact factory for availability.

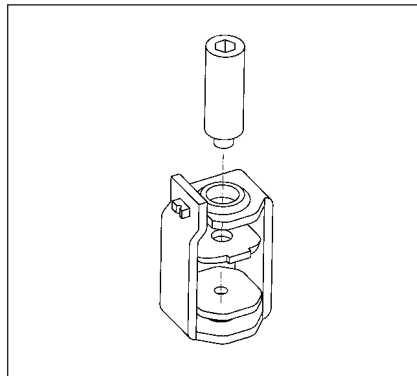

Figure 7. Standard Pressure Type Terminal T250FJ

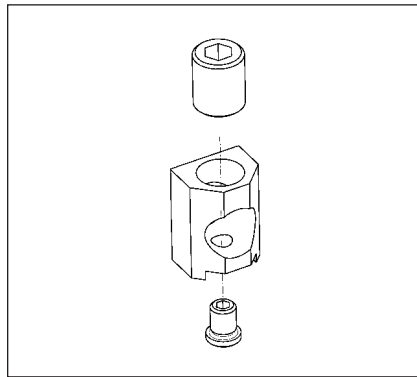

Figure 8. Standard and Optional Pressure Type Terminal TA250FJ/TC250FJ

End Cap Kit

End cap kits are used on J250-Frame breaker line side to connect bus bar or similar electrical connections. Includes hardware.

Table 24. Kit Catalogue Number — for Line or Load

Number of Poles	Catalogue Number	
	Metric	Imperial
3	FJ3RTWK	FJ3RTDK
4	FJ4RTWK	FJ4RTDK

Control Wire Terminal Kit

For use with aluminum or copper terminals only.

Table 25. Control Wire Terminal Kit

Description	Catalogue Number
Package of 14 (Priced Individually)	FJCVTK

Terminal Extensions

Table 26. Terminal Extensions

Number of Poles	Catalogue Number
3	FJTES3
4	FJTES4

Terminal Spreaders

Table 27. Terminal Spreaders

Number of Poles	Catalogue Number
3	FJTEW3
4	FJTEW4

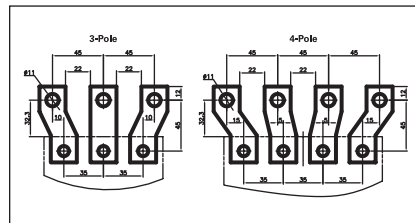

Figure 9. Terminal Spreaders

Multiwire Connectors

Field-installed multiwire connectors for the load side (OFF) end terminals. They are used to distribute the load from the circuit breaker to multiple devices without the use of separate distribution terminal blocks.

Multiwire lug kits include mounting hardware, insulators and tin-plated aluminum connectors to replace three mechanical load lugs. UL listed for copper only as used on the load side (OFF) end.

Table 28. GJ-Frame Multiwire Connectors Ordering Information (Package of 3)

Maximum Amperes	Wires per Terminal	Wire Size Range AWG Cu	Kit Catalogue Number
250	3	14 – 2	3TA250J3
250	6	14 – 6	3TA250J6

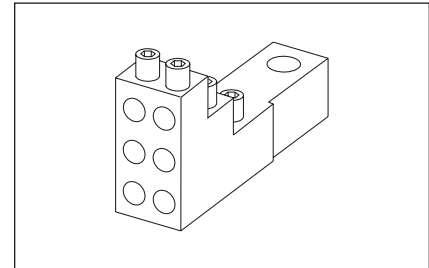

Figure 10. GJ-Frame Multiwire Connectors

Base Mounting Hardware

Base mounting hardware is included with a circuit breaker or Moulded case switch.

Table 29. Terminal Shields IP30

Location	Number of Poles	Catalogue Number Package of 1
Line or Load	2, 3, 4	FJTS3K FJTS4K

Table 30. Interphase Barriers

Package of 2	
Number of Poles	Catalogue Number
3	FJIPBK
4	FJIPBK4

GL-Frame, 630 Amperes



GL Frame

Table 31. UL 489/IEC 60947-2 Interrupting Capacity Ratings

Circuit Breaker Type	Number of Poles	Interrupting Capacity (kA Symmetrical Amperes)									
		Volts ac (50/60 Hz)								Volts dc	
		220 – 240 Vac		380 – 415 Vac		480 Vac	600 Vac	690 Vac		250 V	
		I_{cu}	I_{cs}	I_{cu}	I_{cs}			I_{cu}	I_{cs}	I_{cu}	I_{cs}
GLE	3, 4	65	65	35	35	35	18	12	9	22	22
GLS	3, 4	85	85	50	50	50	25	20	10	22	22
GLH	3, 4	100	100	70	70	65	35	25	13	42	42
GLC	3, 4	200	150	100	75	100	50	35	18	42	42

Table 32. Complete Breaker (Includes Frame, Trip Unit, End Caps and Mounting Hardware) ①

Ampere Rating	3-Pole ②		4-Pole (0%) ③		3-Pole ②		4-Pole (0%) ③		
	Fixed Thermal Adj. Magnetic	Adj. Thermal Adj. Magnetic ④⑤	Fixed Thermal Adj. Magnetic	Adj. Thermal Adj. Magnetic ④⑤	Fixed Thermal Adj. Magnetic	Adj. Thermal Adj. Magnetic ④⑤	Fixed Thermal Adj. Magnetic	Adj. Thermal Adj. Magnetic ④⑤	
IC Rating: 35 kAIC at 415 and 480 Vac					IC Rating: 50 kAIC at 415 and 480 Vac				
250	GLE3250FAM	GLE3250AAM	GLE4250FAM	GLE4250AAM	GLS3250FAM	GLS3250AAM	GLS4250FAM	GLS4250AAM	
300	GLE3300FAM	—	GLE4300FAM	—	GLS3300FAM	—	GLS4350FAM	—	
320	—	GLE3320AAM	—	GLE4320AAM	—	GLS3320AAM	—	GLS4320AAM	
350	GLE3350FAM	—	GLE4350FAM	—	GLS3350FAM	—	GLS4350FAM	—	
400	GLE3400FAM	GLE3400AAM	GLE4400FAM	GLE4400AAM	GLS3400FAM	GLS3400AAM	GLS4400FAM	GLS4400AAM	
500	GLE3500FAM	GLE3500AAM	GLE4500FAM	GLE4500AAM	GLS3500FAM	GLS3500AAM	GLS4500FAM	GLS4500AAM	
600	GLE3600FAM	—	GLE4600FAM	—	GLS3600FAM	—	GLS4600FAM	—	
630 ④	—	GLE3630AAM	—	GLE4630AAM	—	GLS3630AAM	—	GLS4630AAM	
IC Rating: 70 kAIC at 415 Vac, 65 kAIC at 480 Vac					IC Rating: 100 kAIC at 415 and 480 Vac				
250	GLH3250FAM	GLH3250AAM	GLH4250FAM	GLH4250AAM	GLC3250FAM	GLC3250AAM	GLC4250FAM	GLC4250AAM	
300	GLH3300FAM	—	GLH4300FAM	—	GLC3300FAM	—	GLC4300FAM	—	
320	—	GLH3320AAM	—	GLH4320AAM	—	GLC3320AAM	—	GLC4320AAM	
350	GLH3350FAM	—	GLH4350FAM	—	GLC3350FAM	—	GLC4350FAM	—	
400	GLH3400FAM	GLH3400AAM	GLH4400FAM	GLH4400AAM	GLC3400FAM	GLC3400AAM	GLC4400FAM	GLC4400AAM	
500	GLH3500FAM	GLH3500AAM	GLH4500FAM	GLH4500AAM	GLC3500FAM	GLC3500AAM	GLC4500FAM	GLC4500AAM	
600	GLH3600FAM	—	GLH4600FAM	—	GLC3600FAM	—	GLC4600FAM	—	
630 ④	—	GLH3630AAM	—	GLH4630AAM	—	GLC3630AAM	—	GLC4630AAM	

- ① Replace suffix "M" with "W" for no line and load terminals. Replace suffix "M" with "G" for standard cable terminals included.
- ② For 2-pole applications, use two outer poles.
- ③ Neutral protection is indicated by the fourth character: 4 = 0%, 7 = 100%, 8 = adjustable 0 – 60% and 9 = 0 – 100%. 4-pole ground fault option does not have neutral protection.
- ④ 630 amperes is not NEMA rated. 600 amperes is the maximum NEMA rating for the GL.
- ⑤ Adjustable thermal units are typically used in IEC markets and are not NEMA rated.

Table 33. Thermal Magnetic Trip Unit

Ampere Rating	3-Pole ⑥		4-Pole (0%) ⑦	
	Fixed Thermal/ Adj. Magnetic	Adj. Thermal/ Adj. Magnetic ⑧	Fixed Thermal/ Adj. Magnetic	Adj. Thermal/ Adj. Magnetic ⑧
250	LT3250FA	LT3250AA	LT4250FA	LT4250AA
300	LT3300FA	—	LT4300FA	—
320	—	LT3320AA	—	LT4320AA
350	LT3350FA	—	LT4350FA	—
400	LT3400FA	LT3400AA	LT4400FA	LT4400AA
500	LT3500FA	LT3500AA	LT4500FA	LT4500AA
600	LT3600FA	—	LT4600FA	—
630	—	LT3630AA	—	LT4630AA

- ⑥ For 2-pole applications, use two outer poles.
- ⑦ Neutral protection is indicated by the third character: 4 = 0%, 7 = 100%, 8 = adjustable 0 – 60% and 9 = 0 – 100%. 4-pole ground fault option does not have neutral protection.
- ⑧ Adjustable thermal, adjustable magnetic trip units are typically used in IEC markets and are not NEMA rated.

Table 34. Moulded Case Switches

Ampere Rating	Number of Poles	Catalogue Number
400	3 ⑨	GLK3400KSM
	4	GLK4400KSM
630 ⑩	3 ⑨	GLK3630KSM
	4	GLK4630KSM

- ⑨ For 2-pole applications, use two outer poles.
- ⑩ 630 amperes is not NEMA rated. 600 amperes is the maximum NEMA rating for the GL.

Table 35. Components Frame

Ampere Rating ⑪	IC Rating at 415/480 V	3-Pole ⑫	4-Pole (0%)
630	35/35	GLE3630NN	GLE4630NN
630	50/50	GLS3630NN	GLS4630NN
630	70/65	GLH3630NN	GLH4630NN
630	100/100	GLC3630NN	GLC4630NN

- ⑪ 630 amperes is not NEMA rated. 600 amperes is the maximum NEMA rating for the GL.
- ⑫ For 2-pole applications, use two outer poles.

Frame Size GL, 630 Amperes (600 Amperes NEMA)
Table 36. Electronic Trip Units — Digitrip 310+

Ampere Rating	LS	LSI	LSG	LSIG	Neutral CT for LSG & LSIG ①
3-Pole					
250	LT325033	LT325032	LT325035	LT325036	LGFACT250
400	LT340033	LT340032	LT340035	LT340036	LGFACT400
600	LT360033	LT360032	LT360035	LT360036	LGFACT600
630 ②	LT363033	LT363032	LT363035	LT363036	LGFACT630
4-Pole ③					
250	LT425033	LT425032	LT425035	LT425036	LGFACT250
400	LT440033	LT440032	LT440035	LT440036	LGFACT400
600	LT460033	LT460032	LT460035	LT460036	LGFACT600
630 ②	LT463033	LT463032	LT463035	LT463036	LGFACT630

① Required for 4-wire systems if neutral protection is desired.

② 630 amperes is not NEMA rated. 600 amperes is the maximum NEMA rating for the GL.

③ Neutral protection: 4 = 0%, 6 = 60%, 7 = 100%. Electronic trip unit neutral protection is not adjustable. 4-pole ground fault option does not have neutral protection.

Note: Long time pickup — no rating plug needed.

630 Ampere Settings — 630, 600, 500, 400, 350, 315, 300, 250 (315, 630 are IEC ratings only).

600 Ampere Settings — 600, 500, 450, 400, 350, 315, 300, 250 (315 is IEC rating only).

400 Ampere Settings — 400, 350, 315, 300, 250, 225, 200, 160 (315 is IEC rating only).

250 Ampere Settings — 250, 225, 200, 175, 160, 150, 125, 100 (160 is IEC rating only).

Note: Adjustable long time delay — 2 – 24 seconds at $6 \times I_r$.

Adjustable short time delay — Inst., 120, 300 ms.

Note: Plug-in test kit — Catalogue Numbers **MTST120V** (120 Vac) and **MTST230V** (230 Vac).

Digitrip 310+ Test Kit

Digitrip 310+ Test Kit Shown with GJ MCCB

GL Digitrip 310+ Electronic Trip Unit

Table 37. IC Rating at 415/480 V — Complete GL Breakers with Electronic Trip Unit (Includes Frame, Trip Unit, Standard Terminals and Mounting Hardware) ①

Ampere Rating	LS	LSI	LSG	LSIG	Neutral CT for LSG & LSIG ②
3-Pole ③ — IC Rating: 35 kAIC at 415 and 480 Vac					
250	GLE325033M	GLE325032M	GLE325035M	GLE325036M	LGFACT250
400	GLE340033M	GLE340032M	GLE340035M	GLE340036M	LGFACT400
600	GLE360033M	GLE360032M	GLE360035M	GLE360036M	LGFACT600
630 ④	GLE363033M	GLE363032M	GLE363035M	GLE363036M	LGFACT630
4-Pole ⑤ — IC Rating: 35 kAIC at 415 and 480 Vac					
250	GLE425033M	GLE425032M	GLE425035M	GLE425036M	LGFACT250
400	GLE440033M	GLE440032M	GLE440035M	GLE440036M	LGFACT400
600	GLE460033M	GLE460032M	GLE460035M	GLE460036M	LGFACT600
630 ④	GLE463033M	GLE463032M	GLE463035M	GLE463036M	LGFACT630
3-Pole ③ — IC Rating: 50 kAIC at 415 and 480 Vac					
250	GLS325033M	GLS325032M	GLS325035M	GLS325036M	LGFACT250
400	GLS340033M	GLS340032M	GLS340035M	GLS340036M	LGFACT400
600	GLS360033M	GLS360032M	GLS360035M	GLS360036M	LGFACT600
630 ④	GLS363033M	GLS363032M	GLS363035M	GLS363036M	LGFACT630
4-Pole ⑤ — IC Rating: 50 kAIC at 415 and 480 Vac					
250	GLS425033M	GLS425032M	GLS425035M	GLS425036M	LGFACT250
400	GLS440033M	GLS440032M	GLS440035M	GLS440036M	LGFACT400
600	GLS460033M	GLS460032M	GLS460035M	GLS460036M	LGFACT600
630 ④	GLS463033M	GLS463032M	GLS463035M	GLS463036M	LGFACT630
3-Pole ③ — IC Rating: 70 kAIC at 415 Vac, 65 kAIC at 480 Vac					
250	GLH325033M	GLH325032M	GLH325035M	GLH325036M	LGFACT250
400	GLH340033M	GLH340032M	GLH340035M	GLH340036M	LGFACT400
600	GLH360033M	GLH360032M	GLH360035M	GLH360036M	LGFACT600
630 ④	GLH363033M	GLH363032M	GLH363035M	GLH363036M	LGFACT630
4-Pole ⑤ — IC Rating: 70 kAIC at 415 Vac, 65 kAIC at 480 Vac					
250	GLH425033M	GLH425032M	GLH425035M	GLH425036M	LGFACT250
400	GLH440033M	GLH440032M	GLH440035M	GLH440036M	LGFACT400
600	GLH460033M	GLH460032M	GLH460035M	GLH460036M	LGFACT600
630 ④	GLH463033M	GLH463032M	GLH463035M	GLH463036M	LGFACT630

- ① Replace suffix "M" with "W" for no line and load terminals. Replace suffix "M" with "G" for standard cable terminals included.
- ② Required for 4-wire systems if neutral protection is desired.
- ③ For 2-pole applications, use two outer poles.
- ④ 630 amperes is not NEMA rated. 600 amperes is the maximum NEMA rating for the GL.
- ⑤ Neutral protection: 4= 0%, 6 = 60%, 7 = 100%. Electronic trip unit neutral protection is not adjustable. 4-pole with ground fault option does not have neutral protection.

Frame Size GL, 630 Amperes (600 Amperes NEMA)

Line and Load Terminals

Table 38. Line and Load Terminals

Maximum Breaker Amperes	Terminal Body Material	Wire Type	AWG Wire Range/ Number of Conductors	Metric Wire Range (mm ²)	Number of Terminals Included	Catalogue Number
400	Aluminum	Cu/Al	500 – 750 (1)	240 – 380 (1)	3	3TA631LK ①
400	Aluminum	Cu/Al	500 – 750 (1)	240 – 380 (1)	4	4TA631LK ①
400	Copper	Cu	500 – 750 (1)	240 – 380 (1)	3	3T631LK ①
400	Copper	Cu	500 – 750 (1)	240 – 380 (1)	4	4T631LK ①
630	Aluminum	Cu/Al	2 – 500 (2)	35 – 240 (2)	3	3TA632LK ①②
630	Aluminum	Cu/Al	2 – 500 (2)	35 – 240 (2)	4	4TA632LK ①②
630	Copper	Cu	2 – 500 (2)	35 – 240 (2)	3	3T632LK ①
630	Copper	Cu	2 – 500 (2)	35 – 240 (2)	4	4T632LK ①
400	Aluminum	Cu/Al	2 – 500 (1)	35 – 240 (1)	1	TA350LK ②
400	Copper	Cu	2 – 500 (1)	35 – 240 (1)	1	T350LK

① Includes LTS3K (3-pole) or LTS4K (4-pole) terminal covers.
② Standard terminal included with complete breaker.

Table 39. Terminal Covers

Description	Catalogue Number
3-Pole Terminal Cover ③	LTS3K
4-Pole Terminal Cover ③	LTS4K

③ Included in TA631L, T631L, TA632L kits listed above.

Table 40. End Cap Kits

Number of Poles	Catalogue Number
3	L3RTWK
4	L4RTWK

Table 41. Terminal Extensions

Number of Poles	Catalogue Number
3	LGTEW3
4	LGTEW4

Table 42. Terminal Spreaders

Number of Poles	Catalogue Number
3	LGTES3
4	LGTES4

Table 43. Interphase Barriers

Description	Catalogue Number
3 (Pack of 2)	IPB3
4 (Pack of 3)	IPB34

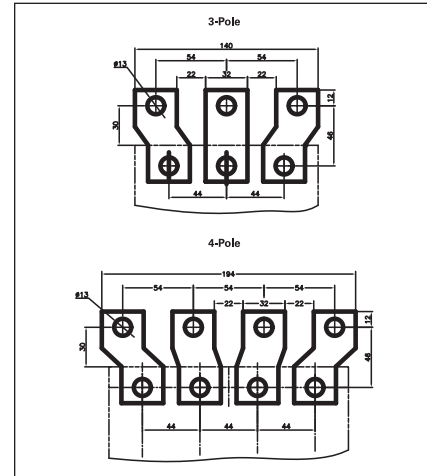

Figure 11. Terminal Spreaders

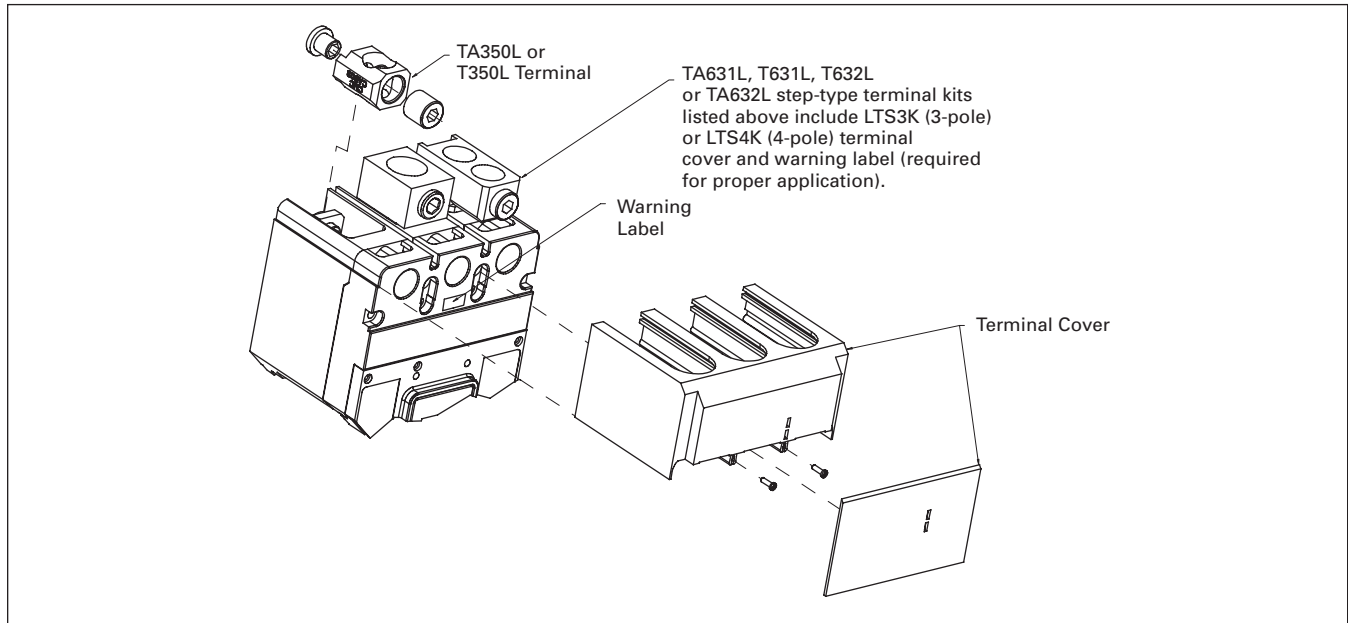

Figure 12. Terminals and Terminal Cover for the GL Breaker — Includes LTS3K (3-Pole) or LTS4K (4-Pole) Terminal Covers

Note: Extended terminal covers add 54.0 mm (2.13 inches) to breaker length.

GN-Frame



GN Frame

1250 Amperes — Selection Guide and Ordering Information

Table 44. UL 489/IEC 60947-2 Interrupting Capacity Ratings

Circuit Breaker Type	Number of Poles	Interrupting Capacity (kA Symmetrical Amperes)									
		Volts ac (50/60 Hz)								Volts dc	
		220 – 240 Vac		380 – 415 Vac		480 Vac	600 Vac	690 Vac		250 V	
		<i>I_{cu}</i>	<i>I_{cs}</i>	<i>I_{cu}</i>	<i>I_{cs}</i>			<i>I_{cu}</i>	<i>I_{cs}</i>	<i>I_{cu}</i>	<i>I_{cs}</i>
S	2, 3, 4 ①	85	85	50	50	50	25	20 ②	10	—	—
H	2, 3, 4 ①	100	100	70	50	65	35	25 ②	13	—	—
C ③	2, 3, 4 ①	200	100	100	50	100	50	35	18	—	—

- ① Neutral on right side.
- ② IEC 60947-2 H.5 Annex H is not KEMA-KEUR tested.
- ③ Not KEMA-KEUR listed.

1600 Amperes — Selection Guide and Ordering Information

Table 45. UL 489/IEC 60947-2 Interrupting Capacity Rating

Circuit Breaker Type	Number of Poles	Interrupting Capacity (kA Symmetrical Amperes)									
		Volts ac (50/60 Hz)								Volts dc	
		220 – 240 Vac		380 – 415 Vac		480 Vac	600 Vac	690 Vac		250 V	
		<i>I_{cu}</i>	<i>I_{cs}</i>	<i>I_{cu}</i>	<i>I_{cs}</i>			<i>I_{cu}</i>	<i>I_{cs}</i>	<i>I_{cu}</i>	<i>I_{cs}</i>
S	2, 3, 4 ④	85	85	50	50	50	25	20 ⑤	10	—	—
H	2, 3, 4 ④	100	100	70	50	65	35	25 ⑤	13	—	—

- ④ Neutral on right side.
- ⑤ IEC 60947-2 H.5 Annex H is not KEMA-KEUR tested.

Frame Size GN, 1250 Amperes 50 kA at 480 Vac or 415 Vac

Table 46. Type GNS Standard Interrupting Capacity — U_e Max. 690 Vac, 50 kA I_{CU} at 480 Vac or 415 Vac

Maximum Continuous Ampere Rating at 40°C ①②	Number of Poles	Circuit Breaker Frame Including Digitrip RMS 310 Electronic Trip Unit without Rating Plugs — Catalogue Number ③				Ampere Rating	Must Add Proper Rating Plug Suffix to Complete Breaker		Separate Rating Plugs			
		LS	LSI	LSG	LSIG		Fixed	Adj.	Fixed	Adjustable		
		L – Adj. Long Delay Pickup (By Adj. Rating Plug) S – Adj. Short Delay Pickup with Fixed Short Delay Time (I^2t Response) or Adj. Short Delay Time (Flat Response) I – Adj. Instantaneous Pickup by Setting Short Delay Time to Inst. G – Adj. Ground Fault Pickup with Adj. Ground Fault Delay (Flat Response)										
Short Time Range		2 – 8 x I_n	2 – 8 x I_n	2 – 8 x I_n	2 – 8 x I_n							
Short Time Delay		—	1 – 300 ms	—	1 – 300 ms							
Ground Fault Pickup		—	—	200 – 1200 A	200 – 1200 A							
Ground Fault Delay		—	—	1 – 500 ms	1 – 500 ms							
800	2-Pole	GNS2800T33W	GNS2800T32W	GNS2800T35W	GNS2800T36W	400	P17	400/500/	8NES400T 8NES450T 8NES500T 8NES550T	400/500/ 600/800		
						450	P16	600/800				
						500	P15	P18				
						550	P14					
						600	P13	400/500/			8NES600T 8NES630T 8NES700T 8NES800T	400/500/ 630/800
						630	P12	630/800				
	700	P11	P19									
	800	P10										
	3-Pole	GNS3800T33W	GNS3800T32W	GNS3800T35W	GNS3800T36W	400	P17	400/500/	8NES400T 8NES450T 8NES500T 8NES550T	400/500/ 600/800		
						450	P16	600/800				
						500	P15	P18				
						550	P14					
600						P13	400/500/	8NES600T 8NES630T 8NES700T 8NES800T			400/500/ 630/800	
630						P12	630/800					
700	P11	P19										
800	P10											
4-Pole ④	GNS4800T33W	GNS4800T32W	⑤	⑤	400	P17	400/500/		8NES400T 8NES450T 8NES500T 8NES550T	400/500/ 600/800		
					450	P16	600/800					
					500	P15	P18					
					550	P14						
					600	P13	400/500/	8NES600T 8NES630T 8NES700T 8NES800T			400/500/ 630/800	
					630	P12	630/800					
700	P11	P19										
800	P10											

NEMA GN 1200 with 1200 A Trip Units is Also Available

1250	2-Pole	GNS2125T33W	GNS2125T32W	GNS2125T35W	GNS2125T36W	600	P07	600/800/	12NES600T 12NES630TW 12NES700T 12NES800T	600/800/ 1000/1200		
						630	P06	1000/1200				
						700	P05	P08				
						800	P04					
						900	P20	630/800/			12NES900T 12NES1000T 12NES1200T 12NES1250TW	630/800/ 1000/1250
						1000	P03	1000/1250				
	1200	P02	P09									
	1250	P01										
	3-Pole	GNS3125T33W	GNS3125T32W	GNS3125T35W	GNS3125T36W	600	P07	600/800/	12NES600T 12NES630TW 12NES700T 12NES800T	600/800/ 1000/1200		
						630	P06	1000/1200				
						700	P05	P08				
						800	P04					
900						P20	630/800/	12NES900T 12NES1000T 12NES1200T 12NES1250TW			630/800/ 1000/1250	
1000						P03	1000/1250					
1200	P02	P09										
1250	P01											
4-Pole ④	GNS4125T33W	GNS4125T32W	⑤	⑤	600	P07	600/800/		12NES600T 12NES630TW 12NES700T 12NES800T	600/800/ 1000/1200		
					630	P06	1000/1200					
					700	P05	P08					
					800	P04						
					900	P20	630/800/	12NES900T 12NES1000T 12NES1200T 12NES1250TW			630/800/ 1000/1250	
					1000	P03	1000/1250					
1200	P02	P09										
1250	P01											

① For ac use only.
 ② GN MCCBs are suitable for 40°C or 50°C applications. Order suffix V3 to eliminate standard 40°C labeling.
 ③ Order terminals separately.
 ④ Unprotected left pole neutral. Insert “E” for 100% neutral or “EH” for 60% neutral between “W” and “P” (e.g., GNS412T32EHP08). 4-pole with ground fault option does not have neutral protection.
 ⑤ Contact Eaton for availability.
Note: GN MCCBs have metric threading on line and load conductors. Use ND MCCBs if imperial threading is required.

Table 47. Moulded Case Switches ⑥⑦

Ampere Rating	Number of Poles	U_e Max. 690 Vac Catalogue Number	
800	3-Pole	GNK3800KSW	MCS Only without Line and Load Terminals
	4-Pole	GNK4800KSW	
1250	3-Pole	GNK312KSW	MCS Only without Line and Load Terminals
	4-Pole	GNK412KSW	

⑥ For ac use only.
 ⑦ For 2-pole applications, use outer poles of 3-pole moulded case switch.

Table 48. Type GNH High Interrupting Capacity — U_g Max. 690 Vac, 65 kA I_{CU} at 480 Vac, 70 kA I_{CU} at 415 Vac

Maximum Continuous Ampere Rating at 40°C ①②	Number of Poles	Circuit Breaker Frame Including Digitrip RMS 310 Electronic Trip Unit without Rating Plugs — Catalogue Number ③				Ampere Rating	Must Add Proper Rating Plug Suffix to Complete Breaker		Separate Rating Plugs	
		LS	LSI	LSG	LSIG		Fixed	Adj.	Fixed	Adjustable
		L – Adj. Long Delay Pickup (By Adj. Rating Plug) S – Adj. Short Delay Pickup with Fixed Short Delay Time (I^2t Response) or Adj. Short Delay Time (Flat Response) I – Adj. Instantaneous Pickup by Setting Short Delay Time to Inst. G – Adj. Ground Fault Pickup with Adj. Ground Fault Delay (Flat Response)								
		2 – 8 x I_n	2 – 8 x I_n I – 300 ms	2 – 8 x I_n — 200 – 1200 A I – 500 ms	2 – 8 x I_n I – 300 ms 200 – 1200 A I – 500 ms					
800	2-Pole	GNH2800T33W	GNH2800T32W	GNH2800T35W	GNH2800T36W	400	P17	400/500/	8NES400T	400/500/
						450	P16	600/800	8NES450T	600/800
						500	P15	P18	8NES500T	A8NES800T1
						550	P14		8NES550T	
	600	P13	400/500/	8NES600T	400/500/					
	630	P12	630/800	8NES630T	630/800					
	700	P11	P19	8NES700T	A8NES800T2					
	800	P10		8NES800T						
	3-Pole	GNH3800T33W	GNH3800T32W	GNH3800T35W	GNH3800T36W	400	P17	400/500/	8NES400T	400/500/
						450	P16	600/800	8NES450T	600/800
						500	P15	P18	8NES500T	A8NES800T1
						550	P14		8NES550T	
600	P13	400/500/	8NES600T	400/500/						
630	P12	630/800	8NES630T	630/800						
700	P11	P19	8NES700T	A8NES800T2						
800	P10		8NES800T							
4-Pole ④	GNH4800T33W	GNH4800T32W	⑤	⑤	400	P17	400/500/	8NES400T	400/500/	
					450	P16	600/800	8NES450T	600/800	
					500	P15	P18	8NES500T	A8NES800T1	
					550	P14		8NES550T		
600	P13	400/500/	8NES600T	400/500/						
630	P12	630/800	8NES630T	630/800						
700	P11	P19	8NES700T	A8NES800T2						
800	P10		8NES800T							

NEMA GN 1200 with 1200 A Trip Units is Also Available

1250	2-Pole	GNH2125T33W	GNH2125T32W	GNH2125T35W	GNH2125T36W	600	P07	600/800/	12NES600T	600/800/
						630	P06	1000/1200	12NES630TW	1000/1200
						700	P05	P08	12NES700T	A12NES1200T1
						800	P04		12NES800T	
	900	P20	630/800/	12NES900T	630/800/					
	1000	P03	1000/1250	12NES1000T	1000/1250					
	1200	P02	P09	12NES1200T	A12NES1250T2					
	1250	P01		12NES1250TW						
	3-Pole	GNH3125T33W	GNH3125T32W	GNH3125T35W	GNH3125T36W	600	P07	600/800/	12NES600T	600/800/
						630	P06	1000/1200	12NES630TW	1000/1200
						700	P05	P08	12NES700T	A12NES1200T1
						800	P04		12NES800T	
900	P20	630/800/	12NES900T	630/800/						
1000	P03	1000/1250	12NES1000T	1000/1250						
1200	P02	P09	12NES1200T	A12NES1250T2						
1250	P01		12NES1250TW							
4-Pole ④	GNH4125T33W	GNH4125T32W	⑤	⑤	600	P07	600/800/	12NES600T	600/800/	
					630	P06	1000/1200	12NES630TW	1000/1200	
					700	P05	P08	12NES700T	A12NES1200T1	
					800	P04		12NES800T		
900	P20	630/800/	12NES900T	630/800/						
1000	P03	1000/1250	12NES1000T	1000/1250						
1200	P02	P09	12NES1200T	A12NES1250T2						
1250	P01		12NES1250TW							

① For ac use only.

② GN MCCBs are suitable for 40°C or 50°C applications. Order suffix V3 to eliminate standard 40°C labeling.

③ Order terminals separately.

④ Unprotected left pole neutral. Insert “E” for 100% neutral or “EH” for 60% neutral between “W” and “P” (e.g., GNS412T32EHP08). 4-pole with ground fault option does not have neutral protection.

⑤ Contact Eaton for availability.

Note: GN MCCBs have metric threading on line and load conductors. Use ND MCCBs if imperial threading is required.

Frame Size GN, 1250 Amperes 100 kA at 480 Vac or 415 Vac

Table 49. Type GNC Very High Capacity — U_e Max. 690 Vac, 100 kA I_{CU} at 480 Vac or 415 Vac

Maximum Continuous Ampere Rating at 40°C ①②	Number of Poles	Circuit Breaker Frame Including Digitrip RMS 310 Electronic Trip Unit without Rating Plugs — Catalogue Number ③				Ampere Rating	Must Add Proper Rating Plug Suffix to Complete Breaker		Separate Rating Plugs		
		LS	LSI	LSG	LSIG		Fixed	Adj.	Fixed	Adjustable	
		L – Adj. Long Delay Pickup (By Adj. Rating Plug) S – Adj. Short Delay Pickup with Fixed Short Delay Time (I^2t Response) or Adj. Short Delay Time (Flat Response) I – Adj. Instantaneous Pickup by Setting Short Delay Time to Inst. G – Adj. Ground Fault Pickup with Adj. Ground Fault Delay (Flat Response)									
Short Time Range		2 – 8 x I_n	2 – 8 x I_n	2 – 8 x I_n	2 – 8 x I_n						
Short Time Delay		—	1 – 300 ms	—	1 – 300 ms						
Ground Fault Pickup		—	—	200 – 1200 A	200 – 1200 A						
Ground Fault Delay		—	—	1 – 500 ms	1 – 500 ms						
800	2-Pole	GNC2800T33W	GNC2800T32W	GNC2800T35W	GNC2800T36W	400	P17	400/500/	8NES400T	400/500/	
						450	P16	600/800	8NES450T	600/800	
						500	P15	P18	8NES500T	600/800	
						550	P14		8NES550T	A8NES800T1	
							600	P13	400/500/	8NES600T	400/500/
							630	P12	630/800	8NES630T	630/800
							700	P11	P19	8NES700T	A8NES800T2
							800	P10		8NES800T	
	3-Pole	GNC3800T33W	GNC3800T32W	GNC3800T35W	GNC3800T36W	400	P17	400/500/	8NES400T	400/500/	
						450	P16	600/800	8NES450T	600/800	
						500	P15	P18	8NES500T	A8NES800T1	
						550	P14		8NES550T		
						600	P13	400/500/	8NES600T	400/500/	
						630	P12	630/800	8NES630T	630/800	
						700	P11	P19	8NES700T	A8NES800T2	
						800	P10		8NES800T		
4-Pole ④	GNC4800T33W	GNC4800T32W	⑤	⑤	400	P17	400/500/	8NES400T	400/500/		
					450	P16	600/800	8NES450T	600/800		
					500	P15	P18	8NES500T	A8NES800T1		
					550	P14		8NES550T			
						600	P13	400/500/	8NES600T	400/500/	
						630	P12	630/800	8NES630T	630/800	
						700	P11	P19	8NES700T	A8NES800T2	
						800	P10		8NES800T		

NEMA GN 1200 with 1200 A Trip Units is Also Available

1250	2-Pole	GNC2125T33W	GNC2125T32W	GNC2125T35W	GNC2125T36W	600	P07	600/800/	12NES600T	600/800/	
						630	P06	1000/1200	12NES630TW	1000/1200	
						700	P05	P08	12NES700T	A12NES1200T1	
						800	P04		12NES800T		
							900	P20	630/800/	12NES900T	630/800/
							1000	P03	1000/1250	12NES1000T	1000/1250
							1200	P02	P09	12NES1200T	A12NES1250T2
							1250	P01		12NES1250TW	
	3-Pole	GNC3125T33W	GNC3125T32W	GNC3125T35W	GNC3125T36W	600	P07	600/800/	12NES600T	600/800/	
						630	P06	1000/1200	12NES630TW	1000/1200	
						700	P05	P08	12NES700T	A12NES1200T1	
						800	P04		12NES800T		
						900	P20	630/800/	12NES900T	630/800/	
						1000	P03	1000/1250	12NES1000T	1000/1250	
						1200	P02	P09	12NES1200T	A12NES1250T2	
						1250	P01		12NES1250TW		
4-Pole ④	GNC4125T33W	GNC4125T32W	⑤	⑤	600	P07	600/800/	12NES600T	600/800/		
					630	P06	1000/1200	12NES630TW	1000/1200		
					700	P05	P08	12NES700T	A12NES1200T1		
					800	P04		12NES800T			
						900	P20	630/800/	12NES900T	630/800/	
						1000	P03	1000/1250	12NES1000T	1000/1250	
						1200	P02	P09	12NES1200T	A12NES1250T2	
						1250	P01		12NES1250TW		

① For ac use only.

② GN MCCBs are suitable for 40°C or 50°C applications. Order suffix V3 to eliminate standard 40°C labeling.

③ Order terminals separately.

④ Unprotected left pole neutral. Insert “E” for 100% neutral or “EH” for 60% neutral between “W” and “P” (e.g., GNS412T32EHP08). 4-pole with ground fault option does not have neutral protection.

⑤ Contact Eaton for availability.

Note: GN MCCBs have metric threading on line and load conductors. Use ND MCCBs if imperial threading is required.

Table 50. Type GNS and GNH Standard and High Interrupting Capacity — U_e Max. 690 Vac, 50 kA I_{CU} /70 kA I_{CU} at 415 Vac

Maximum Continuous Ampere Rating at 40°C ①②	Number of Poles	Circuit Breaker Frame Including Digitrip RMS 310 Electronic Trip Unit and Adjustable Rating Plugs				Adjustable Rating Plug
		LS	LSI	LSG	LSIG	
		L – Adjustable Long Delay Pickup (By Adjustable Rating Plug) S – Adjustable Short Delay Pickup with Fixed Short Delay Time (I ² t Response) or Adjustable Short Delay Time (Flat Response) I – Adjustable Instantaneous Pickup by Setting Short Delay Time to Instantaneous G – Adjustable Ground Fault Pickup with Adjustable Ground Fault Delay (Flat Response)				
Short Time Range		2 – 8 × I _n	2 – 8 × I _n	2 – 8 × I _n	2 – 8 × I _n	
Short Time Delay		—	1 – 300 ms	—	1 – 300 ms	
Ground Fault Pickup		—	—	200 – 1200 A	200 – 1200 A	
Ground Fault Delay		—	—	1 – 500 ms	1 – 500 ms	
1600 ③	3-Pole 4-Pole ④	GNS316T33WP35 GNS416T33WP35	GNS316T32WP35 GNS416T32WP35	GNS316T35WP35 ⑤	GN316T36WP35 ⑤	800/1000/1250/1600
1600	3-Pole 4-Pole	GNH316T33WP35 GNH416T33WP35	GNH316T32WP35 GNH416T32WP35	GNH316T35WP35 ⑤	GNHS316T36WP35 ⑤	800/1000/1250/1600

- ① For ac use only.
- ② GN MCCBs are suitable for 40°C or 50°C applications. Order suffix V3 to eliminate standard 40°C labeling.
- ③ No UL or CSA label is available for the 1600 ampere frame size.
- ④ Unprotected left pole neutral. Insert “1” for 100% protected neutral or “6” for 60% protected neutral before “WP” suffix (e.g., GNS416T336WP35). 4-pole with ground fault option does not have neutral protection.
- ⑤ Contact Eaton for availability.

Note: GN 1600 MCCB uses metric threading on line and load conductors. The GN 1600 is not NEMA rated.

Line and Load Terminals

N-Frame circuit breakers do not include terminals as standard. When copper or Cu/Al terminals are required, order by catalogue number.

Table 51. Line and Load Terminals

Maximum Breaker Amperes	Terminal Body Material	Wire Type	Metric Wire Range mm ²	AWG Wire Number of Conductors	Catalogue Number ⑥
Standard Cu/Al Pressure-Type Terminals					
1250 ⑦	Aluminum	Cu/Al	120 – 300	4/0 – 500 (3)	TA1200NB3M
Optional Copper and Cu/Al Pressure Type Terminals					
1250 ⑦	Copper	Copper	95 – 185	3/0 – 400 (4)	T1200NB3M

- ⑥ Single terminals individually packed.
- ⑦ Not suitable with 1600 ampere frame version.

Terminal Extensions

Table 52. Terminal Extensions

Maximum Breaker Amperes	Number of Poles	Catalogue Number
800	3	GN8TES3
800	4	GN8TES4
1600	3	GN16TES3
1600	4	GN16TES4

Base Mounting Hardware

Base mounting hardware is included with a circuit breaker or Moulded case switch.

Table 53. Base Mounting Hardware

Number of Poles	Description	Catalogue Number
2-, 3- and 4-pole	Imperial Hardware: .3125 – 18 x 1.25 Pan-Head Steel Screws and Lock Washers	BMH5
2-, 3- and 4-pole	Metric Hardware: M8 Pan-Head Steel Screws and Lock Washers	BMH5M

Keeper Nut

Not required on N-Frame. Terminals are threaded.

Handle Extension

Included with breaker. Additional handle extensions are available.

Table 54. Handle Extension

Description	Catalogue Number
Single Handle Extension	HEX5

Interphase Barriers

The interphase barriers provide additional electrical clearance between circuit breaker poles for special termination applications. Barriers are high dielectric insulating plates that are installed in the Moulded slots between the terminals. (Field installation only.)

Table 55. Interphase Barriers

Description	Catalogue Number
3 (Pack of 2)	IPB5
4 (Pack of 3)	IPB54

GR-Frame, 2500 Amperes — Selection Guide and Ordering Information



GR Frame

Table 56. UL 489/IEC 60947-2 Interrupting Capacity Ratings

Circuit Breaker Type	Number of Poles	Interrupting Capacity (kA Symmetrical Amperes)									
		Volts ac (50/60 Hz)								Volts dc	
		220 – 240 Vac		380 – 415 Vac		480 Vac	600 Vac	690 Vac		250 V	
		I_{cu}	I_{cs}	I_{cu}	I_{cs}			I_{cu}	I_{cs}	I_{cu}	I_{cs}
H	3, 4 ^①	135	100	70	50	65	50	25 ^②	13	—	—
C ^③	3, 4 ^①	200	100	100	50	100	65	35 ^②	18	—	—

^① Neutral on right side.

^② IEC 60947-2 H.5 Annex H is not KEMA-KEUR tested.

^③ Not KEMA-KEUR listed.

Table 57. Type GRH with Digitrip 310 High Interrupting Capacity — U_e Max. 690 Vac, 70 kA I_{CU} at 415 Vac

Maximum Continuous Ampere Rating at 40°C ①	Number of Poles	Circuit Breaker Frame Including Digitrip RMS 310 Electronic Trip Unit without Rating Plugs — Catalogue Number ②				Ampere Rating	Must Add Proper Rating Plug Suffix to Complete Breaker		Separate Rating Plugs			
		LS	LSI	LSG ③	LSIG ④		Fixed	Adj.	Fixed	Adj.		
		L – Adj. Long Delay Pickup (By Adj. Rating Plug) S – Adj. Short Delay Pickup with Fixed Short Delay Time (I^2t Response) or Adj. Short Delay Time (Flat Response) I – Adj. Inst. Pickup by Setting Short Delay Time to Instantaneous G – Adj. Ground Fault Pickup with Adj. Ground Fault Delay (Flat Response)										
Short Time Range		2 – 8 x I_n	2 – 8 x I_n	2 – 8 x I_n	2 – 8 x I_n							
Short Time Delay		—	1 – 300 ms	—	1 – 300 ms							
Ground Fault Pickup		—	—	200 – 1200 A	200 – 1200 A							
Ground Fault Delay		—	—	1 – 500 ms	1 – 500 ms							
1600 ①	3-Pole	GRH316T33W	GRH316T32W	GRH316T35W	GRH316T36W	800	P07	800/1000/	16RES08T	800/1000/		
						1000	P06	1200/1600			16RES10T	1200/1600
						1200	P05					
1250	P04		16RES125T									
1400	P03	800/1000/			16RES14T	800/1000/						
1500	P02	1250/1600					16RES15T	1250/1600				
1600	P01		16RES16T	A16RES16T2								
2000		GRH320T33W	GRH320T32W	GRH320T35W	GRH320T36W	1000	P15	1000/1200/	20RES10T	1000/1200/		
						1200	P14	1600/2000			20RES12T	1600/2000
						1250	P13					
1400	P12	1000/1250/	A20RES14T	1000/1250/								
1600	P11	1600/2000			A20RES16T	1600/2000						
2000	P10						A20RES20T	A20RES20T2				
2500		GRH325T33W	GRH325T32W	GRH325T35W	GRH325T36W	1200	P34	1200/1600/	25RES12T	1200/1600/		
						1250	P35	2000/2500			25RES125T	2000/2500
						1600	P36					
2000	P37	1250/1600/	A25RES20T	1250/1600/								
2500	P38	2000/2500			A25RES25T	2000/2500						
	P40						A25RES25T2					
1600 ①	4-Pole ④	GRH416T33W	GRH416T32W	⑤	⑤	800	P07	800/1000/	16RES08T	800/1000/		
						1000	P06	1200/1600			16RES10T	1200/1600
						1200	P05					
1250	P04		16RES125T									
1400	P03	800/1000/			16RES14T	800/1000/						
1500	P02	1250/1600					16RES15T	1250/1600				
1600	P01		16RES16T	A16RES16T2								
2000		GRH420T33W	GRH420T32W	⑤	⑤	1000	P15	1000/1200/	20RES10T	1000/1200/		
						1200	P14	1600/2000			20RES12T	1600/2000
						1250	P13					
1400	P12	1000/1250/	A20RES14T	1000/1250/								
1600	P11	1600/2000			A20RES16T	1600/2000						
2000	P10						A20RES20T	A20RES20T2				
2500		GRH425T33W	GRH425T32W	⑤	⑤	1200	P34	1200/1600/	25RES12T	1200/1600/		
						1250	P35	2000/2500			25RES125T	2000/2500
						1600	P36					
2000	P37	1250/1600/	A25RES20T	1250/1600/								
2500	P38	2000/2500			A25RES25T	2000/2500						
	P40						A25RES25T2					

① For SCR application, use 2000 ampere frame.
 ② Order terminals separately. Mounting hardware not included.
 ③ Ground fault equipped trip units available with remote indicating panel. Add "R" to catalogue number, e.g., "GRH316T35RW."
 ④ Unprotected left pole neutral. Add "P" to catalogue number for 100% protected left pole neutral, add "E" for 60% protected, e.g., "GRH416T33PW", "GRH416T33EW."
 ⑤ Contact Eaton for availability.

Note: GR MCCBs have metric threading on line and load conductors. Use RD MCCBs if imperial threading is required.

Frame Size GR, 2500 Amperes 100 kA at 480 Vac, 415 Vac — Digitrip 310 Trip Unit

Table 58. Type GRC with Digitrip 310 Very High Interrupting Capacity — U_e Max. 690 Vac, 100 kA I_{cu} at 415 Vac

Maximum Continuous Ampere Rating at 40°C ①	Number of Poles	Circuit Breaker Frame Including Digitrip RMS 310 Electronic Trip Unit without Rating Plugs — Catalogue Number ②				Ampere Rating	Must Add Proper Rating Plug Suffix to Complete Breaker		Separate Rating Plugs	
		LS	LSI	LSG ③	LSIG ③		Fixed	Adj.	Fixed	Adj.
		L – Adj. Long Delay Pickup (By Adj. Rating Plug) S – Adj. Short Delay Pickup with Fixed Short Delay Time (I^2t Response) or Adj. Short Delay Time (Flat Response) I – Adj. Inst. Pickup by Setting Short Delay Time to Inst. G – Adj. Ground Fault Pickup with Adj. Ground Fault Delay (Flat Response)								
Short Time Range Short Time Delay Ground Fault Pickup Ground Fault Delay		2 – 8 x I_n — — —	2 – 8 x I_n 1 – 300 ms — —	2 – 8 x I_n — 200 – 1200 A 1 – 500 ms	2 – 8 x I_n 1 – 300 ms 200 – 1200 A 1 – 500 ms					
1600 ①	3-Pole	GRC316T33W	GRC316T32W	GRC316T35W	GRC316T36W	800	P07	800/1000/1200/1600	16RES08T	800/1000/1200/1600
						1000	P06		16RES10T	
						1200	P05		16RES12T	
						1250	P04		16RES125T	
						1400	P03	800/1000/1250/1600	16RES14T	800/1000/1250/1600
						1500	P02		16RES15T	
						1600	P01		16RES16T	A16RES16T2
2000		GRC320T33W	GRC320T32W	GRC320T35W	GRC320T36W	1000	P15	1000/1200/1600/2000	20RES10T	1000/1200/1600/2000
						1200	P14		20RES12T	
						1250	P13		A20RES125T	A20RES20T1
						1400	P12	1000/1250/1600/2000	A20RES14T	1000/1250/1600/2000
						1600	P11		A20RES16T	
						2000	P10		A20RES20T	A20RES20T2
2500 ④		GRC325T33W	GRC325T32W	GRC325T35W	GRC325T36W	1200	P34	1200/1600/2000/2500	25RES12T	1200/1600/2000/2500
						1250	P35		25RES125T	
						1600	P36		A25RES16T	A25RES25T1
						2000	P37	1250/1600/2000/2500	A25RES20T	1250/1600/2000/2500
						2500	P38		A25RES25T	A25RES25T2
							P40			
1600 ①	4-Pole ⑤	GRC416T33W	GRC416T32W	④	④	800	P07	800/1000/1200/1600	16RES08T	800/1000/1200/1600
						1000	P06		16RES10T	
						1200	P05		16RES12T	A16RES16T1
						1250	P04		16RES125T	
						1400	P03	800/1000/1250/1600	16RES14T	800/1000/1250/1600
						1500	P02		16RES15T	
						1600	P01		16RES16T	A16RES16T2
2000		GRC420T33W	GRC420T32W	④	④	1000	P15	1000/1200/1600/2000	20RES10T	1000/1200/1600/2000
						1200	P14		20RES12T	
						1250	P13		A20RES125T	A20RES20T1
						1400	P12	1000/1250/1600/2000	A20RES14T	1000/1250/1600/2000
						1600	P11		A20RES16T	
						2000	P10		A20RES20T	A20RES20T2
2500 ④		GRC425T33W	GRC425T32W	④	④	1200	P34	1200/1600/2000/2500	25RES12T	1200/1600/2000/2500
						1250	P35		25RES125T	
						1600	P36		A25RES16T	A25RES25T1
						2000	P37	1250/1600/2000/2500	A25RES20T	1250/1600/2000/2500
						2500	P38		A25RES25T	A25RES25T2
							P40			

- ① For SCR application, use 2000 ampere frame.
- ② Order terminals separately. Mounting hardware not included.
- ③ Ground fault equipped trip units available with remote indicating panel. Add "R" to catalogue number, e.g., "GRH316T35RW."
- ④ Contact Eaton for availability.
- ⑤ Unprotected left pole neutral. Add "P" to catalogue number for 100% protected left pole neutral, add "E" for 60% protected, e.g., "GRH416T33PW", "GRH416T33EW."

Note: GR MCCBs have metric threading on line and load conductors. Use RD MCCBs if imperial threading is required.

Table 59. Moulded Case Switches

Ampere Rating	Number of Poles	Catalogue Number
1600 2000	3-Pole	GRK316WK GRK320WK
1600 2000	4-Pole	GRK416WK GRK420WK

Table 60. Type GR with Digitrip 610 and 910

Maximum Continuous Ampere Rating at 40°C	Number of Poles	Circuit Breaker Frame Including Digitrip RMS 610 and 910 Electronic Trip Unit with Adjustable Rating Plugs Order as Individual Component — Catalogue Number ①					Digitrip RMS Interchangeable Rating Plug (Order as Individual Component)		
		L – Adjustable Long Delay Pickup (I_p) with Adjustable Long Delay Time S – Adjustable Short Delay Pickup with Adjustable Short Delay Time (I^2t or Flat Response) I – Adjustable Instantaneous Pickup G – Adjustable Ground Fault Pickup with Adjustable Ground Fault Time Delay (I^2t or Flat Response)					Fixed Rating Plug	Ampere Rating	Catalogue Number
		LI	LS	LSI	LIG	LSG	LSIG		
Long Delay Pickup	0.5 – 1.0 x I_n	0.5 – 1.0 $_n$	0.5 – 1.0 x I_n	0.5 – 1.0 x I_n	0.5 – 1.0 x I_n	0.5 – 1.0 x I_n	0.5 – 1.0 x I_n		
Long Delay Time	2 – 24 Seconds	2 – 24 Seconds	2 – 24 Seconds	2 – 24 Seconds	2 – 24 Seconds	2 – 24 Sec.	2 – 24 Seconds		
Short Time Range	2 – 6 x I_r	2 – 6 x I_r	2 – 6 x I_r	2 – 6 x I_r	2 – 6 x I_r	2 – 6 x I_r	2 – 6 x I_r		
Short Time Delay	—	100 – 500 ms	100 – 500 ms	100 – 500 ms	—	100 – 500 ms	100 – 500 ms		
Instantaneous	2 – 6 x M1 & M2	—	2 – 6 x M1 & M2	2 – 6 x M1 & M2	—	—	2 – 6 x M1 & M2		
Ground Fault Pickup	—	—	—	0.25 – 1.0 x I_n ②	—	0.25 – 1.0 x I_n ②	0.25 – 1.0 x I_n ②		
Ground Fault Delay	—	—	—	100 – 500 ms	—	100 – 500 ms	100 – 500 ms		

Type GRH with Digitrip 610 High Interrupting Capacity — U_g Max. 690 Vac, 70 kA I_{CU} at 415 Vac

1600	3-Pole	GRH316T61WP44	GRH316T63WP44	GRH316T62WP44	GRH316T64WP44	GRH316T65WP44	GRH316T66WP44	800	RP6R16A080
		Includes 1600 A Rating Plug						1000	RP6R16A100
2000		GRH320T61WP49	GRH320T63WP49	GRH320T62WP49	GRH320T64WP49	GRH320T65WP49	GRH320T66WP49	1200	RP6R16A120
		Includes 2000 A Rating Plug						1250	RP6R16A125
2500		GRH325T61WP53	GRH325T63WP53	GRH325T62WP53	GRH325T64WP53	GRH325T65WP53	GRH325T66WP53	1600	RP6R20A160
		Includes 2500 A Rating Plug						2000	RP6R20A200
								2500	RP6R25A250

Type GRC with Digitrip 610 Very High Interrupting Capacity — U_g Max. 690 Vac, 100 kA I_{CU} at 415 Vac

1600	3-Pole	GRC316T61WP44	GRC316T63WP44	GRC316T62WP44	GRC316T64WP44	GRC316T65WP44	GRC316T66WP44	800	RP6R16A080
		Includes 1600 A Rating Plug						1000	RP6R16A100
2000		GRC320T61WP49	GRC320T63WP49	GRC320T62WP49	GRC320T64WP49	GRC320T65WP49	GRC320T66WP49	1200	RP6R16A120
		Includes 2000 A Rating Plug						1250	RP6R16A125
2500 ③		GRC325T61WP53	GRC325T63WP53	GRC325T62WP53	GRC325T64WP53	GRC325T65WP53	GRC325T66WP53	1600	RP6R20A160
		Includes 2500 A Rating Plug						2000	RP6R20A200
								2500	RP6R25A250

Type GRH with Digitrip 910 High Interrupting Capacity — U_g Max. 690 Vac, 70 kA I_{CU} at 415 Vac

1600	3-Pole	GRH316T91WP44	GRH316T93WP44	GRH316T92WP44	GRH316T94WP44	GRH316T95WP44	GRH316T96WP44	800	RP6R16A080
		Includes 1600 A Rating Plug						1000	RP6R16A100
2000		GRH320T91WP49	GRH320T93WP49	GRH320T92WP49	GRH320T94WP49	GRH320T95WP49	GRH320T96WP49	1200	RP6R16A120
		Includes 2000 A Rating Plug						1250	RP6R16A125
2500		GRH325T91WP53	GRH325T93WP53	GRH325T92WP53	GRH325T94WP53	GRH325T95WP53	GRH325T96WP53	1600	RP6R20A160
		Includes 2500 A Rating Plug						2000	RP6R20A200
								2500	RP6R25A250

Type GRC with Digitrip 910 Very High Interrupting Capacity — U_g Max. 690 Vac, 100 kA I_{CU} at 415 Vac

1600	3-Pole	GRC316T91WP44	GRC316T93WP44	GRC316T92WP44	GRC316T94WP44	GRC316T95WP44	GRC316T96WP44	800	RP6R16A080
		Includes 1600 A Rating Plug						1000	RP6R16A100
2000		GRC320T91WP49	GRC320T93WP49	GRC320T92WP49	GRC320T94WP49	GRC320T95WP49	GRC320T96WP49	1200	RP6R16A120
		Includes 2000 A Rating Plug						1250	RP6R16A125
2500 ③		GRC325T91WP53	GRC325T93WP53	GRC325T92WP53	GRC325T94WP53	GRC325T95WP53	GRC325T96WP53	1600	RP6R20A160
		Includes 2500 A Rating Plug						2000	RP6R20A200
								2500	RP6R25A250

① Order terminals separately. Mounting hardware not included.

② Not to exceed 1200 ampere ground fault pickup.

③ Contact Eaton for availability.

Note: GR MCCBs have metric threading on line and load conductors. Use RD MCCBs if imperial threading is required.

Frame Size GR, 800 – 2500 Amperes

Line and Load Terminals

R-Frame circuit breakers use Cu/Al terminals as standard and copper only terminals as an option. Specify if factory installation is required.

Table 61. Line and Load Terminals

Maximum Breaker Amperes	Terminal Body Material	Wire Type	Hardware	AWG/kcmil Wire Range/ Number of Conductors	Metric Wire Range mm ²	Catalogue Number
-------------------------	------------------------	-----------	----------	--	-----------------------------------	------------------

Wire Terminals

1600	Aluminum	Cu/Al	Metric	500 – 1000 (4)	300 – 500	TA1600RDM ①
1600	Copper	Cu	Metric	1 – 600 (4)	50 – 300	T1600RDM ①
2000	Aluminum	Cu/Al	Metric	2 – 600 (6)	35 – 300	TA2000RDM ②

Rear Connectors

2000	Copper	—	Metric	—	—	B2016RDM ①
2000	Copper	—	Metric	—	—	B2016RDLM ①
2500	Copper	—	Metric	—	—	B2500RDM ①

① Order one per pole — single terminals individually packed.

② Order one TA2000RD kit per 3-poles. Catalogue number includes bus connection, terminals and hardware for either line side or load side of 3-pole breaker.

Note: GR MCCBs have metric threading on line and load conductors. Use RD MCCBs if imperial threading is required.

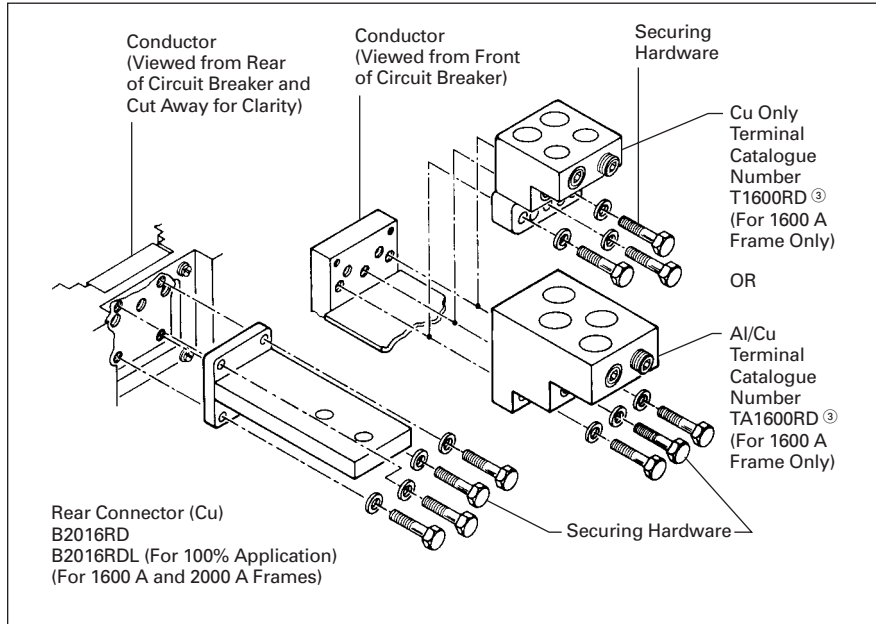

Figure 13. GR Rear Connector Exploded View

③ Order one per pole (or two per pole if line and load terminals are required) — single terminals individually packed.

Note: GR MCCBs have metric threading on line and load conductors. Use RD MCCBs if imperial threading is required.

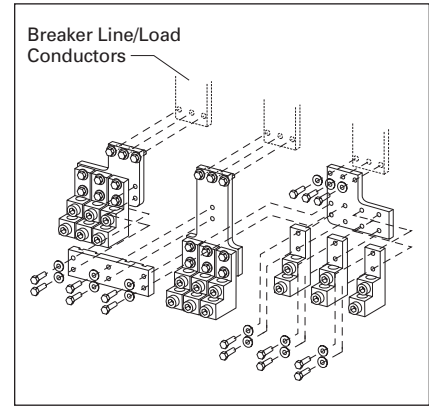

Figure 14. TA2000RD Wire Terminal

Note: Order one TA2000RDM kit per 3-poles. Catalogue number includes bus connection, terminals and hardware for either line side or load side of 3-pole breaker.

Base Mounting Hardware

Supplied by customer.

Handle Extension

Included with breaker. Additional handle extensions are available.

Table 62. Handle Extension

Description	Catalogue Number
Single Handle Extension	HEX6

Motor Circuit Protectors — Selection Guide and Ordering Information

Table 63. GE-Frame — 600Y/347 Vac Maximum, 250 Vdc Maximum ①

Continuous Amperes	Cam Setting	Motor Full Load Current Amperes ②	MCP Trip Setting ③	MCP Catalogue Number
3	A	.69 – .91	9	HMCPE003A0C
	B	1.1 – 1.3	15	
	C	1.6 – 1.7	21	
	D	2.0 – 2.2	27	
	E	2.3 – 2.5	30	
	F	– 2.6	33	
7	A	1.5 – 2.0	21	HMCPE007C0C
	B	2.6 – 3.1	35	
	C	3.7 – 3.9	49	
	D	4.8 – 5.2	63	
	E	5.3 – 5.7	70	
	F	5.8 – 6.1	77	
15	A	3.4 – 4.5	45	HMCPE015E0C
	B	5.7 – 6.8	75	
	C	8.0 – 9.1	105	
	D	10.4 – 11.4	135	
	E	11.5 – 12.6	150	
	F	12.7 – 13.0	165	
30	A	3.9 – 9.1	90	HMCPE030H1C
	B	11.5 – 13.7	150	
	C	16.1 – 18.3	210	
	D	20.7 – 22.9	270	
	E	23.0 – 25.2	300	
	F	25.3 – 26.1	330	
50	A	11.5 – 15.2	150	HMCPE050K2C
	B	19.2 – 22.9	250	
	C	26.9 – 30.6	350	
	D	34.6 – 38.3	450	
	E	38.4 – 42.1	500	
	F	42.2 – 43.5	550	
70	A	16.1 – 30.6	210	HMCPE070M2C
	B	26.9 – 32.2	350	
	C	37.6 – 42.9	490	
	D	48.4 – 53.7	630	
	E	53.8 – 59.1	700	
	F	59.2 – 60.9	770	
100	A	23.0 – 30.6	300	HMCPE100R3C
	B	38.4 – 46.0	500	
	C	53.8 – 61.4	700	
	D	69.2 – 76.8	900	
	E	76.9 – 84.5	1000	
	F	84.6 – 87.0	1100	
100	A	38.4 – 46.0	500	HMCPE100T3C
	B	57.6 – 65.2	750	
	C	76.9 – 84.5	1000	
	D	④	1250	
	E	④	1375	
	F	④	1500	

① UL listed for use with Cutler-Hammer Motor Starters.

② Motor FLA ranges are typical. The corresponding trip setting is at 13 times the minimum FLA value shown. Where a 13 times setting is required for an intermediate FLA value, alternate cam settings and/or MCP ratings should be used.

③ For dc applications, actual trip levels are approximately 40% higher than values shown.

④ Settings above 10xI_n are for special applications. Where the ampere rating of the disconnecting means cannot be less than 115% of the motor full load ampere rating.

Table 64. GJ-Frame — 600 Vac Maximum, 250 Vdc Maximum ⑤

Continuous Amperes	MCP Trip Range (Amperes)	MCP Catalogue Number
250	500 – 1000 625 – 1250 750 – 1500	HMCPJ250D5L HMCPJ250F5L HMCPJ250G5L
	875 – 1750 1000 – 2000 1125 – 2250 1250 – 2500	HMCPJ250J5L HMCPJ250K5L HMCPJ250L5L HMCPJ250W5L

⑤ UL listed for use with Cutler-Hammer Motor Starters.

Table 65. GL-Frame — 600 Vac Maximum, 250 Vdc Maximum ⑥⑦

Continuous Amperes	MCP Trip Range (Amperes)	MCP Catalogue Number
600	1125 – 2250 1500 – 3000 1750 – 3500	HMCPGL600L HMCPGL600N HMCPGL600R
	2000 – 4000 2250 – 4500 2500 – 5000 3000 – 6000	HMCPGL600X HMCPGL600Y HMCPGL600P HMCPGL600M

⑥ Equipped with an electronic trip device.

⑦ UL listed for use with Cutler-Hammer Motor Starters.

Table 66. GN-Frame — 600 Vac Maximum ⑧⑨

Continuous Amperes	Cam Setting	Motor Full Load Current Amperes	MCP Trip Setting	MCP Catalogue Number
800	A	123.1 – 184.5	1600	HMCP800X7W
	B	184.6 – 246.1	2400	
	C	246.2 – 307.6	3200	
	D	307.2 – 369.1	4000	
	E	369.2 – 430.7	4800	
	F	430.8 – 492.2	5600	
	G	492.3 – 553.7	6400	
1200	A	184.6 – 276.8	2400	HMCP12Y8W
	B	276.9 – 369.1	3600	
	C	369.2 – 461.4	4800	
	D	461.5 – 553.7	6000	
	E	553.8 – 646.1	7200	
	F	646.2 – 738.4	8400	
	G	738.5 – 830.7	9600	

⑧ UL listed for use with Cutler-Hammer Motor Starters.

⑨ Equipped with an electronic trip device.

30 mA Ground Fault (Earth Leakage) Modules

**30 mA Ground Fault
(Earth Leakage) Modules**



Clockwise from Left: GJ, GL, GE MCCBs Shown with Ground Fault (Earth Leakage) Modules

Eaton offers a 3- and 4-pole 30 mA ground fault (earth leakage) protection module for GE, GJ and GL breakers. The module does not restrict the use of other breaker accessories. UL-listed modules are available for GJ and GL MCCBs. The IEC-rated GE module is side mounted for circuits up to 125 amperes, while the GJ and GL modules are both bottom mounted for circuits up to 160 and 250 amperes (GJ), or 400 and 630 amperes for the GL.

The module is completely self-contained since the current sensor, relay and power supply are located inside the product. Current pickup settings are selectable from 0.03 – 10 amperes for all IEC-rated modules and GJ UL-listed module, and 0.03 – 30 amperes for the GL UL-listed modules. Time delays are also selectable from Instantaneous – 1.0 seconds for 0.10 ampere settings and above. A current pickup setting of 0.03 amperes defaults to an Instantaneous time setting regardless of the time dial's position. Two alarm contacts come as standard: a 50% pre-trip and a 100% after trip, both based only on earth leakage current levels.

Product Selection

Table 67. GE-Frame Earth Leakage Modules, IEC (Side Mounted, 230 – 415 Vac, 50/60 Hz)

Amperes	Poles	Catalogue Number
125	3	ELESE3125W
125	4	ELESE4125W

Table 68. GJ-Frame Ground Fault Modules, UL-Rated (Bottom Mounted, 120 – 480 Vac, 50/60 Hz)

Amperes	Poles	Catalogue Number
150	3	ELJBN3150W
150	4	ELJBN4150W
250	3	ELJBN3250W
250	4	ELJBN4250W

Table 69. GJ-Frame Earth Leakage Modules, IEC (Bottom Mounted, 230 – 415 Vac, 50/60 Hz)

Amperes	Poles	Catalogue Number
160	3	ELJBE3160W
160	4	ELJBE4160W
250	3	ELJBE3250W
250	4	ELJBE4250W

Table 70. GL-Frame Ground Fault Modules, UL-Rated (Bottom Mounted, 120 – 480 Vac, 50/60 Hz)

Amperes	Poles	Catalogue Number
400	3	ELLBN3400W
400	4	ELLBN4400W
600	3	ELLBN3600W
600	4	ELLBN4600W

Table 71. GL-Frame Earth Leakage Modules, IEC (Bottom Mounted, 230 – 415 Vac, 50/60 Hz)

Amperes	Poles	Catalogue Number
400	3	ELLBE3400W
400	4	ELLBE4400W
630	3	ELLBE3630W
630	4	ELLBE4630W



Figure 15. UL-Rated GL-Frame Earth Leakage Module Faceplate

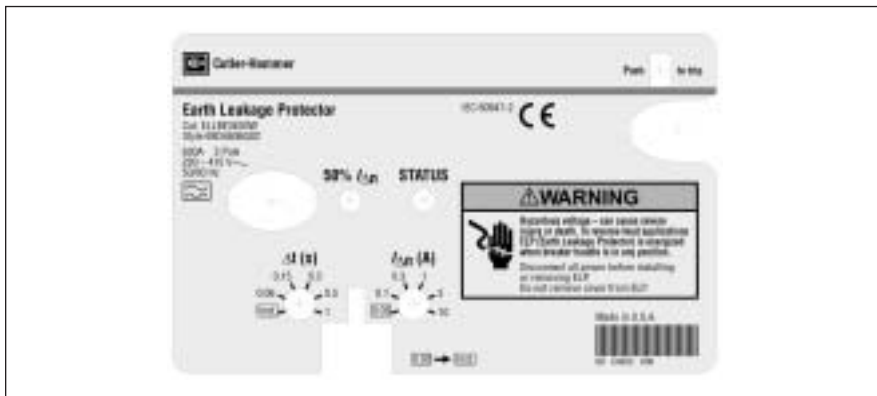

Figure 16. IEC-Rated GL-Frame Earth Leakage Module Faceplate

Special Features and Accessories

Internal Accessories

Alarm Lockout

The alarm switches operate when the circuit breaker is tripped by a short circuit or overcurrent, but also when it is tripped by a shunt trip or undervoltage release.

Auxiliary Switches

Auxiliary switches are used for signaling and control purposes. The various functions of the auxiliary switches (changeover) are shown in Figure 18.

Shunt Trips

The shunt trip is used for remote tripping.

The coil of the shunt trip is rated only for short-time operation.

It is not permissible with the circuit breaker open to apply a continuous opening command to the shunt trip in order to prevent the breaker from closing. This means that interlocking circuits with continuous commands may not be set up with shunt trips.

Undervoltage Releases

The circuit breaker cannot be closed until the undervoltage release is energized. If the release is not energized, the circuit breaker can only perform an idle switching operation.

Frequent idle switching actions should be avoided as they shorten the endurance of the circuit breaker.

Accessory Configurations for GE – GR Circuit Breakers

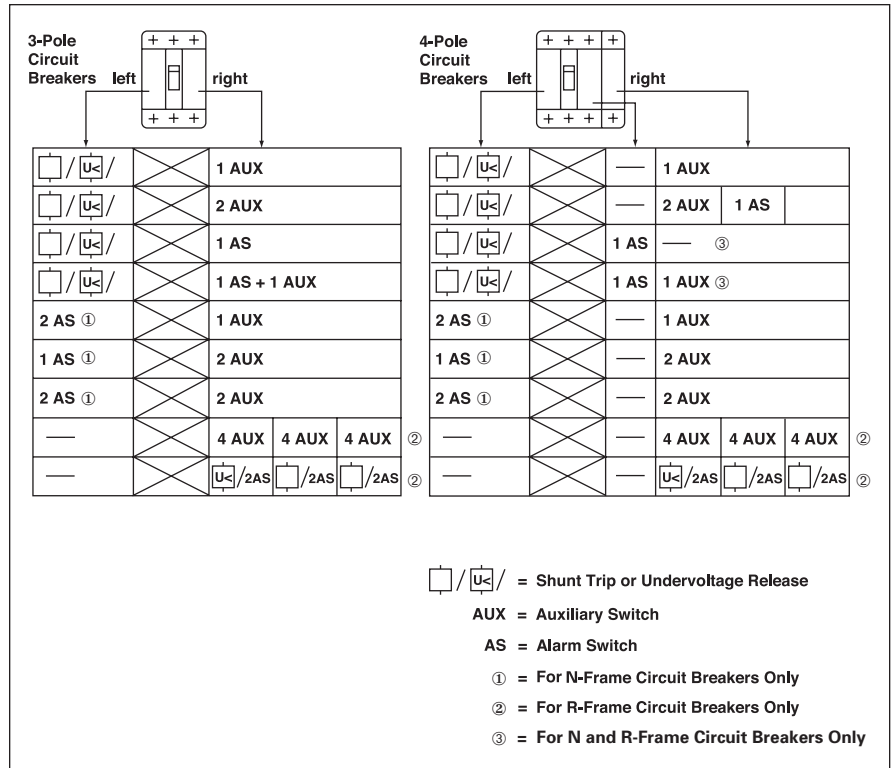

Figure 17. Internal Accessory Configurations

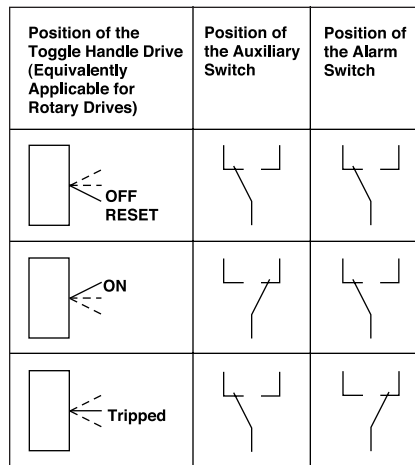

Figure 18. Contact Making by the Auxiliary and Alarm Switches as a Function of the Switching Position of the Circuit Breaker

Special Features and Accessories

Special Calibration

Special non-UL listed calibrations are available for certain ambient temperatures other than 40°C and for frequencies other than 50/60 Hz or dc. Reduced interrupting ratings will apply for 400 Hz applications.

50°C Calibration

Note: Breakers equipped with electronic trip units can operate reliably in ambient temperatures of 50°C. Add suffix "V3" to GN MCCBs to remove standard 40°C labeling.

Add suffix "V" to catalogue number for complete thermal magnetic breaker when ordering listed ampere ratings for breakers to be used in 50°C ambients. 50°C ambient MCCBs are not UL listed.

Contact Eaton for availability.

Moisture-Fungus Treatment

All Eaton Circuit Breaker cases are Moulded from glass-polyester which does not support the growth of fungus. Any parts which are susceptible to the growth of fungus will require special treatment.

Order by description.

Table 72. Calibrations and Treatment

Description	Frame				
	GE	GJ	GL	GN	GR
Special Calibration	✓	✓	✓	✓	✓
Moisture-Fungus Treatment	✓	✓	✓	✓	✓

Table 73. External Accessories and Test Kit

Description	Fit Type	Frame				
		GE	GJ	GL	GN	GR
External Accessories						
Non-Padlockable Handle Block	Field	EFHB	—	—	LKD4	—
Padlockable Handle Block	Field	EFPHB	FJPHB	LBHP	—	—
Padlockable Handle Block Off-Only	Field	EFPHBOFF	FJPHBOFF	LBHPOFF	—	—
Padlockable Handle Lock Hasp	Field	EFPHL	FJPHL	LPHL	PLK5	HLK6
Padlockable Handle Lock Hasp Off-Only	Field	EFPHLOFF	FJPHLOFF	LPHLOFF	—	—
Cylinder Lock	Factory	Order by Description				
Key Interlock Kit ^①	Field	—	KYKFJ	KYKL	KYK4	KYK6
Slide Bar Interlock ^②	Field	EFSBI	FJSBI	SBKL3	SBK5	—
Walking Beam Interlock ^②	Factory	—	FJWBI	WBLL3630	WBL5	WBL6
Electrical Operator	120 Vac	EOPEF240C	EOPFJ240C	EOPLG240C	EOP5T07	EOP6T08
	240 Vac	EOPEF240C	EOPFJ240C	EOPLG240C	EOP5T11	EOP6T11K
	380 Vac	—	—	—	—	—
	24 Vdc	EOPEF24D	EOPFJ24D	EOPLG24D	EOP5T21	EOP6T19K
	48 Vdc	EOPEF48D	EOPFJ48D	EOPLG48D	EOP5T22	EOP6T21K
	125 Vdc	EOPEF240C	EOPFJ240C	EOPLG240C	EOP5T26	—
Plug-In Adapters	3-Pole	PAD3E	PAD3J	PAD3LG	PAD53	—
	4-Pole	PAD4E	PAD4J	PAD4LG	PAD54	—
Rear Connecting Studs	Field	③	③	③	③	—
Test Kit						
Electronic Portable Test Kit ^④	—	⑤	⑤	⑤	STK2	STK2

① Provision only.





② Requires two breakers.

③ Contact Eaton for catalogue numbers.

④ Digitrip 310 only.

⑤ Catalogue Numbers **MTST120V** (120 Vac) and **MTST230V** (230 Vac).

Table 74. Accessories

Description	Pole Location	Frame			
		GE, GJ & GL	GN	GR	
Field Fit Kit Catalogue Numbers					
Alarm Lockout 	Make/Break	Left	—	A1L5LPK	—
		Right	ALM1M1BEPK ①	A1L5RPK	A1L6RPK
	2 Make/2 Break	Left	—	A2L5LPK	—
		Right	ALM2M2BEPK ②	A2L5RPK	A2L6RPK
Auxiliary Switch 	1A, 1B	Left	—	A1X5LPK	—
		Right	AUX1A1BPK	A1X5RPK	—
	2A, 2B	Left	—	A2X5LPK	—
		Right	AUX2A2BPK	A2X5RPK	A2X6RPK
	3A, 3B	Left	—	A3X5LPK	—
		Right	—	A3X5RPK	—
	4A, 4B	Left	—	—	—
		Right	—	—	A4X6RPK
Auxiliary Switch /Alarm Lockout	Left	—	AA115LPK	—	
	Right	AUXALRMEPK ③	AA115RPK	—	
Shunt Trip — Standard 	120 Vac	Left	SNT120CPK	SNT5LP11K	—
		Right	—	—	SNT6P11K
	240 Vac	Left	SNT120CPK	SNT5LP11K	—
		Right	—	—	SNT6P11K
	24 Vdc	Left	SNT060CPK	SNT5LP03K	—
		Right	—	—	SNT6P03K
	48 Vdc	Left	SNT060CPK	SNT5LP23K	—
		Right	—	—	SNT6P23K
	380 – 600 Vac	Left	SNT480APK	—	—
		Right	—	—	—
220 – 250 Vdc or 380 – 440 Vac	—	—	SNT5LP14K	SNT6P14K	
480 – 600 Vac	—	—	SNT5LP18K	SNT6P18K	
Shunt Trip — Low Energy	Left	—	LST5LPK	—	
	Right	—	—	LST6RPK	
Undervoltage Release Mechanism 	120 Vac	Left	UVR120APK	UVH5LP08K	—
		Right	—	—	UVH6RP08K
	208 – 240 Vac	Left	UVR240APK	UVH5LP11K	—
		Right	—	—	UVH6RP11K
	24 Vdc, Vac	Left	UVR024CPK	UVH5LP21K	—
		Right	—	—	UVH6RP21K
	48 Vdc	Left	UVR048DPK	UVH5LP23K	—
		Right	—	—	UVH6RP23K
	12 Vdc, Vac	Left	UVR012CPK	—	—
		Right	—	—	—
	48 Vac	Left	UVR048APK	UVHLP05K	—
		Right	—	—	UVHRP05K
	120 Vdc	Left	UVR125DPK	UVHLP26K	—
		Right	—	—	UVHRP26K
	220 – 250 Vdc	Left	UVR250DPK	UVHLP28K	—
		Right	—	—	UVHRP28K
	380 – 500 Vac	Left	UVR480APK	UVHLP29K	—
		Right	—	—	UVHRP29K
525 – 600 Vac	Left	UVR600APK	—	—	
	Right	—	—	—	
12 Vdc	Left	—	UVHLP20K	—	
	Right	—	—	UVH6RP20K	
12 Vac	Left	—	UVHLP02K	—	
	Right	—	—	UVH6RP02K	

① Part number for GJ and GL is ALM1M1BJPK.
 ② Part number for GJ and GL is ALM2M2BJPK.
 ③ Part number for GJ and GL is AUXALRMJPK.

Plug-in Blocks and Drawout Cassettes

Plug-in Blocks

Plug-in adapters simplify installation and front removal of circuit breakers. Plug-ins are available for rear connection applications on 3- and 4-pole circuit breakers. Trip on drawout interlock kits are included. Stabs for GE, GJ and GL plug-ins rotate 90° for flexible installation. Use terminal shields for IP30 protection.



GL Breaker with Plug-in Block

Product Selection

Table 75. Plug-in Blocks

Breaker Frame	Poles	Catalogue Number
---------------	-------	------------------

GE-, GJ- and GL-Frame Plug-in Blocks

GE	3	PAD3E
GE	4	PAD4E
GJ	3	PAD3J
GJ	4	PAD4J
GL	3	PAD3L
GL	4	PAD4L

Trip-on Drawout Interlock Kit ①

GE	3, 4	PIILEG
GJ	3, 4	PIILJG
GL	3, 4	PIILLG

Terminal Shields IP30

GE	3	EFTS3K
GE	4	EFTS4K
GJ	3	FJTS3K
GJ	4	FJTS4K
GL	3	LTS3K
GL	4	LTS4K

① Included with plug-in block. Trips the breaker when breaker is removed from plug-in block.

Drawout Cassette



Drawout Cassette

The Drawout Cassette is currently for use with the standard 3-pole 65 and 100 kA/480 Vac, 1600 ampere and 2000 ampere GR circuit breakers only. It consists of two separate components: the movable mechanism which is factory mounted to the circuit breaker frame (shown in photo above) and the stationary mechanism which is housed in the cassette and shipped separately.

The drawout mechanism has four positions.

- Connected — The breaker is fully connected to the primary stabs and secondary contacts.
- Test — The breaker is not connected to the primary stab but is connected to the secondary contacts.
- Disconnected — Both the primary stabs and the secondary contacts are disconnected.
- Withdraw — The breaker can be removed from the cassette.

Table 76. GR Drawout Cassette

Description	Catalogue Number
65 kA/480 Vac Version	
Movable Mechanism	RD20DOM ②
Stationary Mechanism	RD20DOS (without shutters) RD20DOSS (with shutters)
100 kA/480 Vac Version	
Movable Mechanism	RD20DOM ②
Stationary Mechanism	RD20DOS (without shutters) RD20DOSS (with shutters)

② List price included in price of the stationary mechanism.

Movable mechanism must be ordered with GR circuit breaker and is shipped mounted to circuit breaker frame. Stationary mechanism is ordered separately.

All internal accessories must be factory installed for use with drawout.

Handle Mechanisms Overview

Handle mechanisms are used to operate Moulded case circuit breakers, Moulded case switches and motor circuit protectors. They are available in three basic configurations — Flange Mounted, Through-the-Door and Direct (Close-Coupled) — providing safe, dependable operation and ease of installation.

Flange Mounted

- Flex Shaft

Through-the-Door

- Universal Rotary

Direct (Close Coupled)

- Universal Direct
- Euro IEC

Handle mechanisms are typically used on enclosed circuit breakers, control panels and motor control centers in many different applications. Eaton Electrical has a handle mechanism for virtually any need.

Flange Mounted Handle Mechanisms

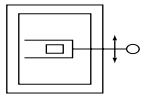

The Flex Shaft™

Flange Mounted handle mechanisms mount on the flange of an enclosure door. The Flex Shaft is an extra heavy-duty mechanism that includes a flexible shaft in various lengths, 0.9 m (3 feet) through 3 m (10 feet) for use with various size enclosures.

The Flex Shaft handle will accept up to three padlock shackles, each with a maximum diameter of 9.5 mm (3/8 inch). Can be used with NEMA 12 fabricated enclosures. An optional handle is available for Flex Shaft that is suitable for use with NEMA 4 environments.

Flex Shaft comes preset from the factory, requiring only minor field adjustments on installation, which takes about 10 minutes — a significant time savings compared to installation of other types of flange handle mechanisms. The Flex Shaft mechanism also takes up less interior enclosure space than competitive designs and the handle fits standard flange cutouts. Flex Shaft handle can be remotely mounted from breaker, where an operator can use it by “funneling” the cable through conduit.

Flex Shaft is UL listed under File E64893 and meets CSA requirements.

Flex Shaft Ordering Information

Table 77. Flex Shaft Ordering Information

Breaker Frame	Flexible Shaft Length in Meters (Feet)							
	Catalogue Number							
	0.9 (3)	1.2 (4)	1.3 (5)	1.8 (6)	2.1 (7)	2.4 (8)	2.7 (9)	3.1 (10)
GE	EHMFS03	EHMFS04	EHMFS05	EHMFS06	EHMFS07	EHMFS08	EHMFS09	EHMFS10
GJ	JHMFS03	JHMFS04	JHMFS05	JHMFS06	JHMFS07	JHMFS08	JHMFS09	JHMFS10
GL	—	LHMFS04	—	—	LHMFS07	—	—	LHMFS10
GN	N/A	F5S04CI	F5S05CI	F5S06CI	N/A	N/A	N/A	F5S10CI
GR	N/A	F6S04	F6S05	F6S06	N/A	N/A	N/A	N/A

Note: Add Suffix L to the complete Catalogue Number for 152.4 mm (6-inch) handle.

Flex Shaft Accessories (E- through R-Frame)

Table 78. Standard Door Hardware (Required Adapter Kit)

Latch	Panel Height in mm (Inches)	Catalogue Number
2 Point	Up to 762.0 (30.00)	DH1R
2 Point	Up to 1016.0 (40.00)	DH2R
3 Point	Over 1016.0 (40.00)	DH3R

Table 79. Door Hardware Adapter Kit (Required on Standard Door Hardware)

Description	Catalogue Number
Door Hardware Adapter Kit	AMTDHA

Table 80. NEMA 12 Safety Door Hardware for Flex Shaft ①

Handle Length in mm (Inches)	Catalogue Number ②
101.6 (4.00)	C361KJ4
152.4 (6.00)	C361KJ6
Roller Latch ③	C361KR

① Customer: Consult with box manufacturer for correct door hardware and any adapters required for assembly.

② The 6.35 x 12.7 mm (1/4-inch x 1/2-inch) standard mill rectangular locking bar is not supplied with these kits.

③ Third roller latch for use with 101.6 or 152.4 mm (4- or 6-inch) handle when 3 point latching is required.

Table 81. NEMA — IP Crossover

NEMA Type	IP Type
1	IP20
3R	IP55
12	IP54
4/4X	IP66

Note: NEMA 4X handle mechanisms are available. Add Suffix X to the complete Catalogue Number.

Original narrow handle design (No C Suffix) is available. Remove C from Catalogue Number.

Note: When selecting the length of shaft, ensure minimum bending radius of 4 inches (101.6 mm) is maintained to operate properly.

The standard method of shipment includes the mechanism preset at the factory; however, minor field adjustments may be required.

Handle Mechanisms

Through-the-Door Handle Mechanisms

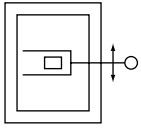

Universal Rotary

The Eaton Universal Rotary is suitable for use with NEMA 12 enclosure types. An optional NEMA 4/4X handle mechanism is also available. All rotary handle mechanisms include a handle "Lock Off," to prevent turning the breaker ON while in the OFF position. All Rotary handles indicate ON/OFF/Tripped/Reset positions, however, Universal Rotary has the added feature of international markings for ON (I) and OFF (O). The Universal Rotary is made of Moulded material.

The Universal Rotary mechanisms for GE, GJ and GL MCCBs can be operated by hand with the door open or "locked off" to prevent operation with the door open.

For the GN-Frame MCCBs, a Eaton Rotary with a metal handle (**Table 83**) is also available.

Table 82. Universal Rotary Ordering Information

Shaft Length in mm (Inches)	Handle Colour	Complete Catalogue Number ^{①②}
-----------------------------	---------------	---

GE-Frame

152.4 (6.00)	Black	EHMVD06B
304.8 (12.00)	Black	EHMVD12B
609.6 (24.00)	Black	EHMVD24B
152.4 (6.00)	Red	EHMVD06R
304.8 (12.00)	Red	EHMVD12R
609.6 (24.00)	Red	EHMVD24R

GJ-Frame

152.4 (6.00)	Black	FJHMVD06B
304.8 (12.00)	Black	FJHMVD12B
609.6 (24.00)	Black	FJHMVD24B
152.4 (6.00)	Red	FJHMVD06R
304.8 (12.00)	Red	FJHMVD12R
609.6 (24.00)	Red	FJHMVD24R

GL-Frame

152.4 (6.00)	Black	KLHMVD06B
304.8 (12.00)	Black	KLHMVD12B
609.6 (24.00)	Black	KLHMVD24B
152.4 (6.00)	Red	KLHMVD06R
304.8 (12.00)	Red	KLHMVD12R
609.6 (24.00)	Red	KLHMVD24R

GN-Frame

152.4 (6.00)	Black	HMVD5B
--------------	-------	---------------

GR-Frame

235.0 (9.00)	Black	HMVD6B
--------------	-------	---------------

① Complete catalogue number includes handle, mechanism, shaft and mounting hardware.

② Add suffix "X" for NEMA 4/4X.

Table 83. Eaton Rotary Ordering Information — GN-Frame

Shaft Length in mm (Inches)	Handle Colour	Complete Catalogue Number ^③	
		NEMA 1, 3R, 12	NEMA 4/4X
152.4 (6.00)	Black	WHM5R06	WHM5R06X
304.8 (12.00)	Black	WHM5R12	WHM5R12X
406.4 (16.00)	Black	WHM5R16	WHM5R16X
609.6 (24.00)	Black	WHM5R24	WHM5R24X

③ Complete catalogue number includes handle, mechanism, shaft and mounting hardware.

Handle Mechanisms

**Direct (Close-Coupled)
Handle Mechanisms**



Universal Direct (GE – GL)

Direct (Close-Coupled) Handle Mechanisms mount directly to the circuit breaker. They are used in shallow enclosures where the standard variable depth Through-the-Door type mechanism is not practical or cannot be used. They are typically for applications where high volume, standardized enclosures are being fabricated.

The Universal Direct handle mechanism is designed exclusively for the new Eaton GE, GJ and GL circuit breakers. It is available as standard with a door interlock to prevent opening the enclosure while the circuit breaker is in the ON position. It is also available without a door interlock.

The Universal Direct handle mechanism is UL 489 listed, IEC 60947-1/2 and meets CSA requirements.

The Euro IEC Direct handle mechanism is designed for GN and GR MCCBs. The Euro IEC Direct handle mechanism is 60947-112.

Table 84. Universal Direct Ordering Information

Frame	White Handle Colour		Red Handle Colour
	with Interlock	without Interlock	without Interlock
	Catalogue Number		
GE	EHMCCBI	EHMCCB	EHMCCR
GJ	JHMCCBI	JHMCCB	JHMCCR
GL	LHMCCBI	LHMCCB	LHMCCR

Table 85. Euro IEC Direct Ordering Information

Frame	Catalogue Number
	Black Handle
GN	HMVD5B
GR	HMVD6B

Time Current Curves

Tripping Characteristics

The operating values specified for the inverse time overcurrent releases (thermal overload releases, "a" releases) are mean values of the scatter bands of all setting ranges from the cold state and with uniform current loading of the conducting paths.

The tripping characteristics of the instantaneous (electromagnetic) short circuit releases ("n" releases) are based on the rated phase current I_n which in the case of circuit breakers with adjustable thermal overload releases is also the upper value of the setting range. With a lower setting current, a correspondingly higher multiple is obtained for the operating current of the "n" release.

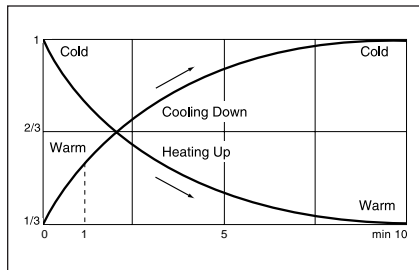

Figure 19. Tripping Time Characteristics (Thermal Memory)

Type GE

Tripping characteristics of GE circuit breakers for plant protection, "n" release fixed setting = 400 – 600 for breaker 15 – 45 A; over 50 A = $10 \times I_n$.

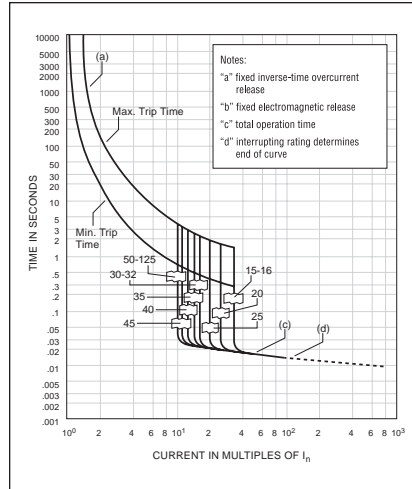

Figure 20. GE Time Current Curve

Type GJ

Tripping characteristics of GJ circuit breakers for plant protection, "n" release adjustable.

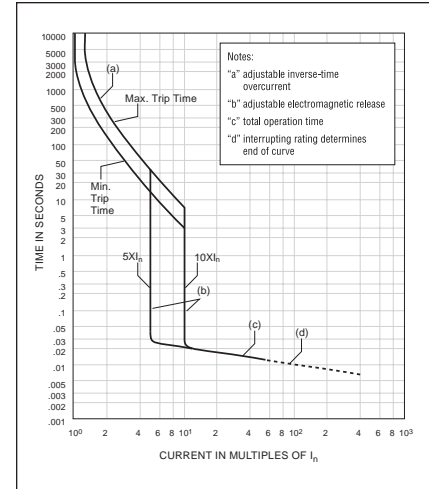

Figure 21. GJ Time Current Curve for Thermal Magnetic Trip Units

Type GL

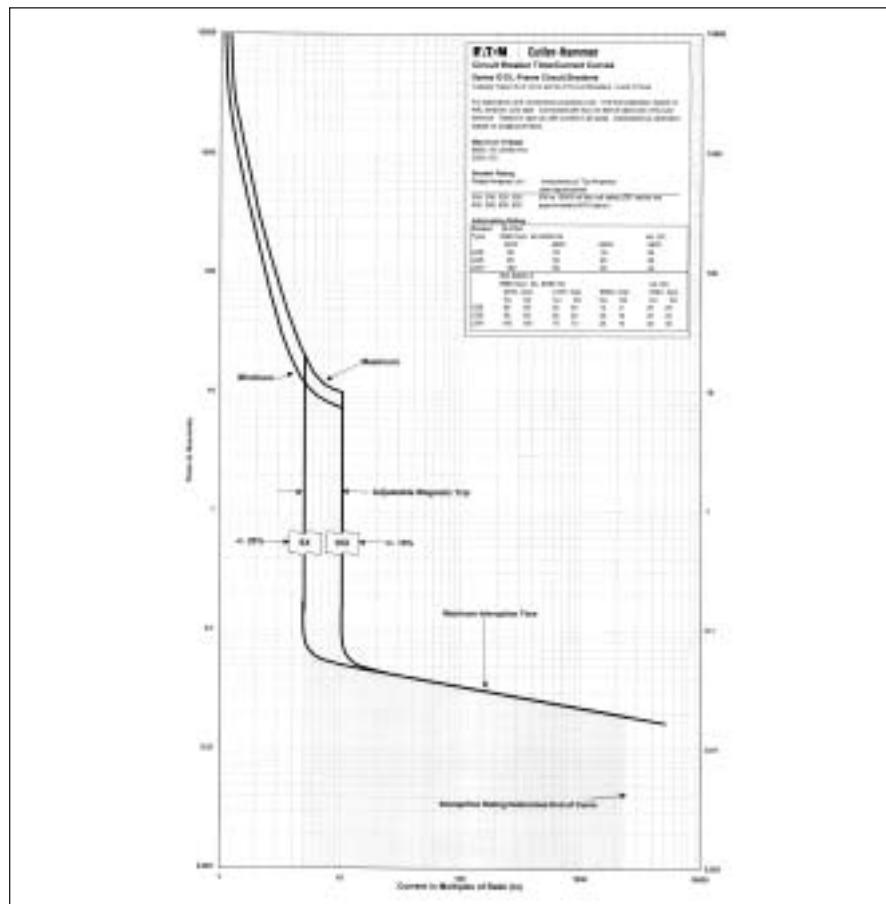

Figure 22. GL Time Current Curve for Thermal Magnetic Trip Units

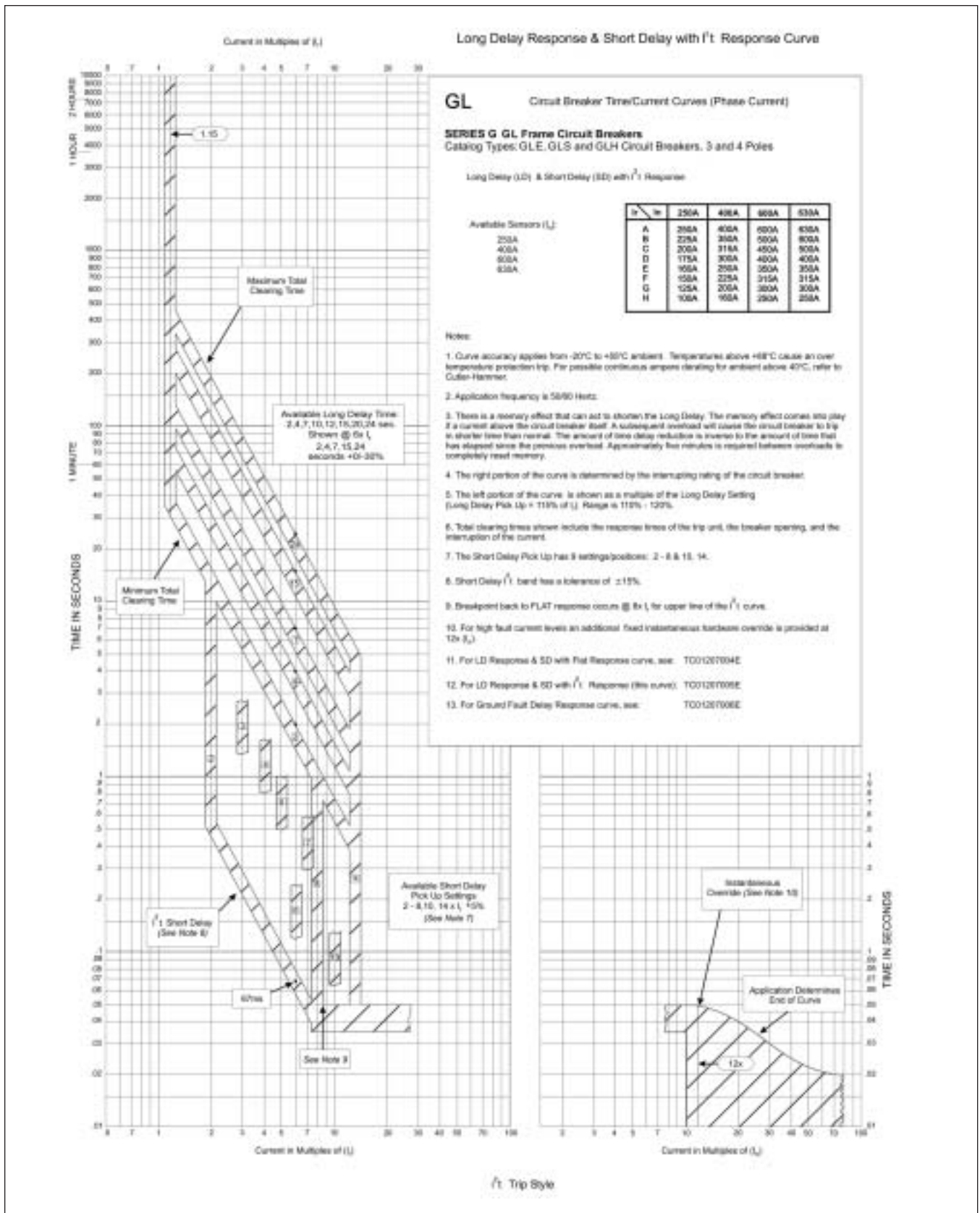

Figure 23. GL Electronic Trip Unit Long Delay Response and Short Delay with I^2t Response Curve

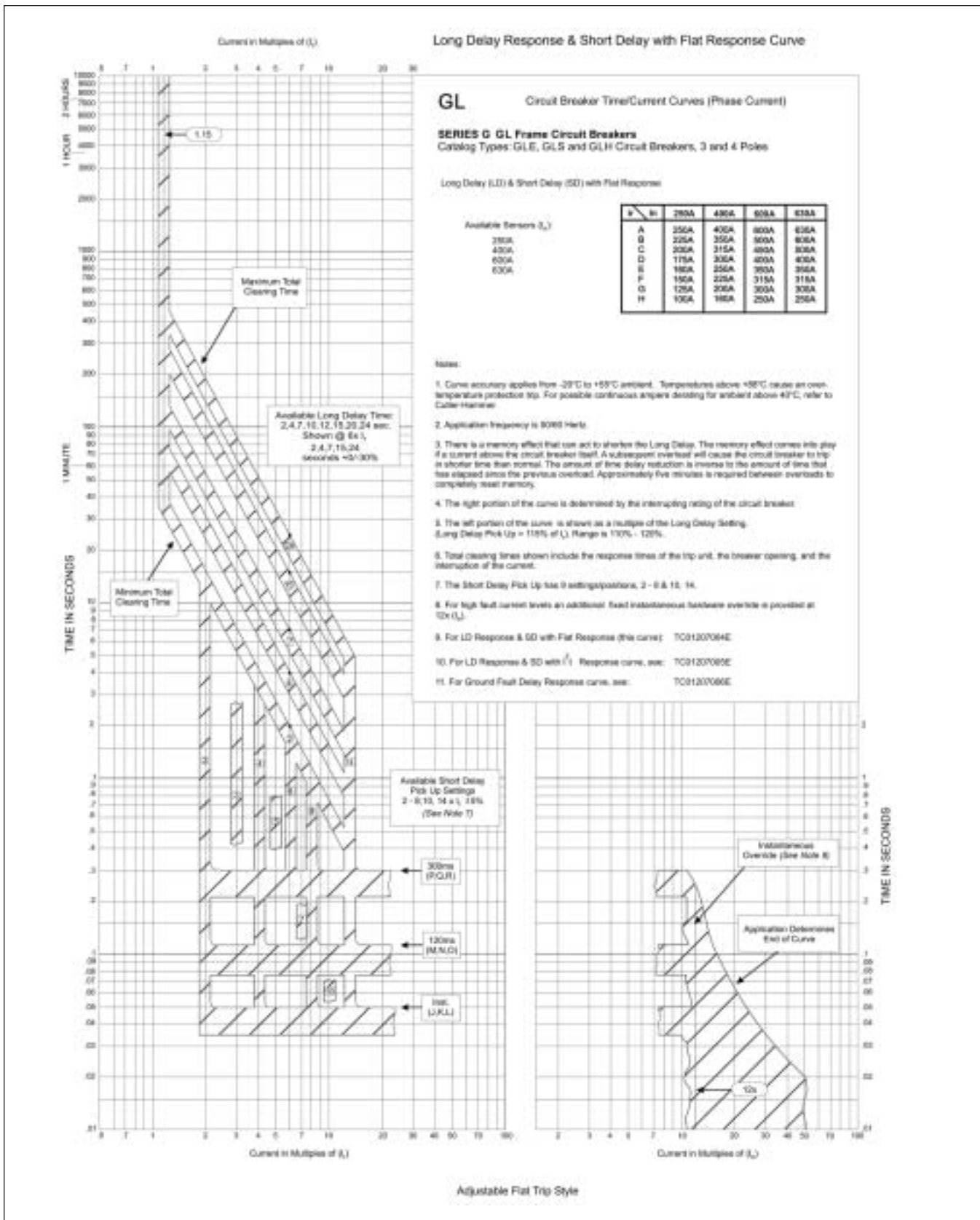

Figure 24. GL Electronic Trip Unit Long Delay Response and Short Delay with Flat Response Curve

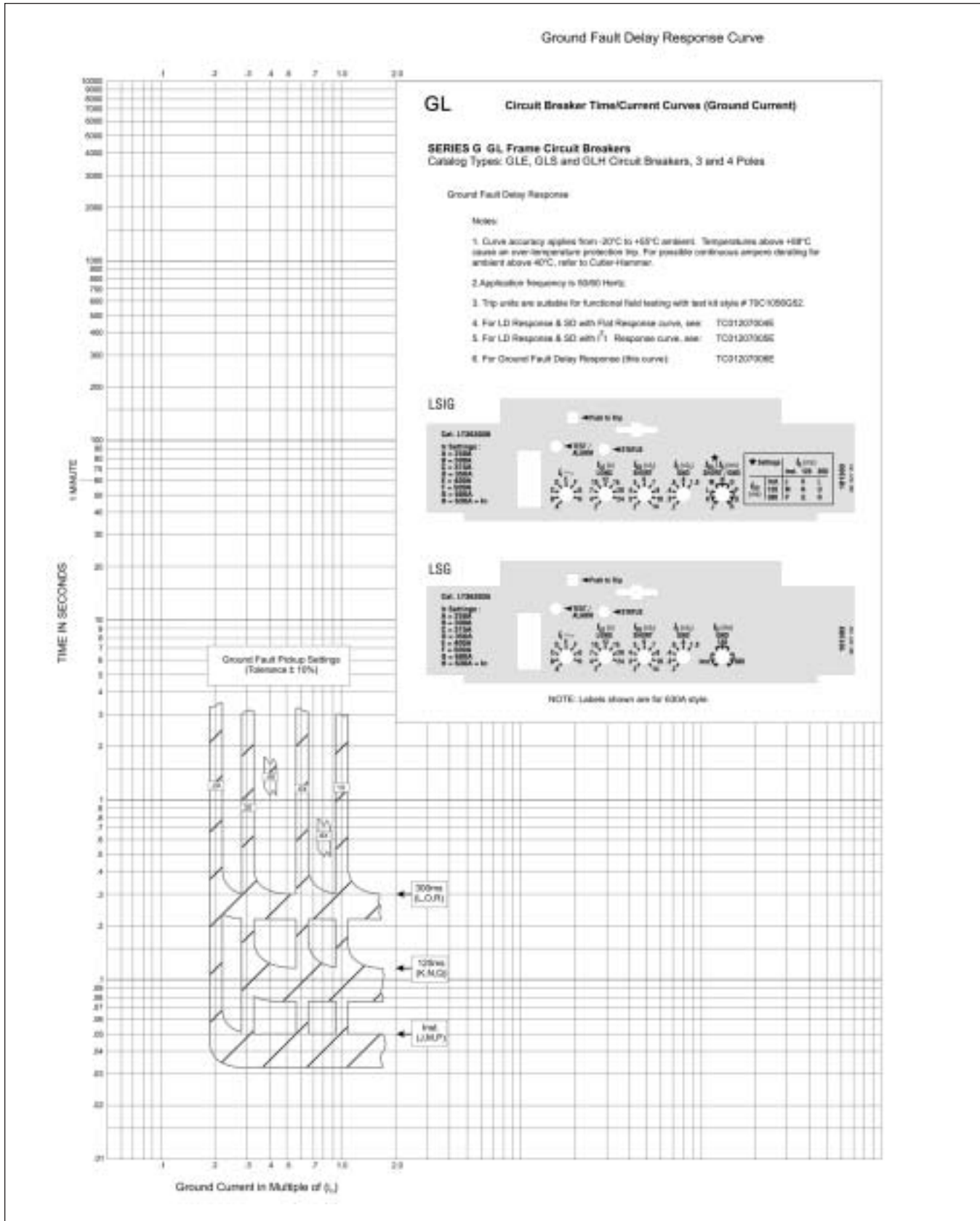

Figure 25. GL Electronic Trip Unit Ground Fault Delay Response Curve

Type GN

Tripping characteristics of GN circuit breakers with solid-state overcurrent release.

Working Temperature Range

The tolerance bands shown are applicable to an ambient temperature range of -5 to +60°C at the circuit breaker.

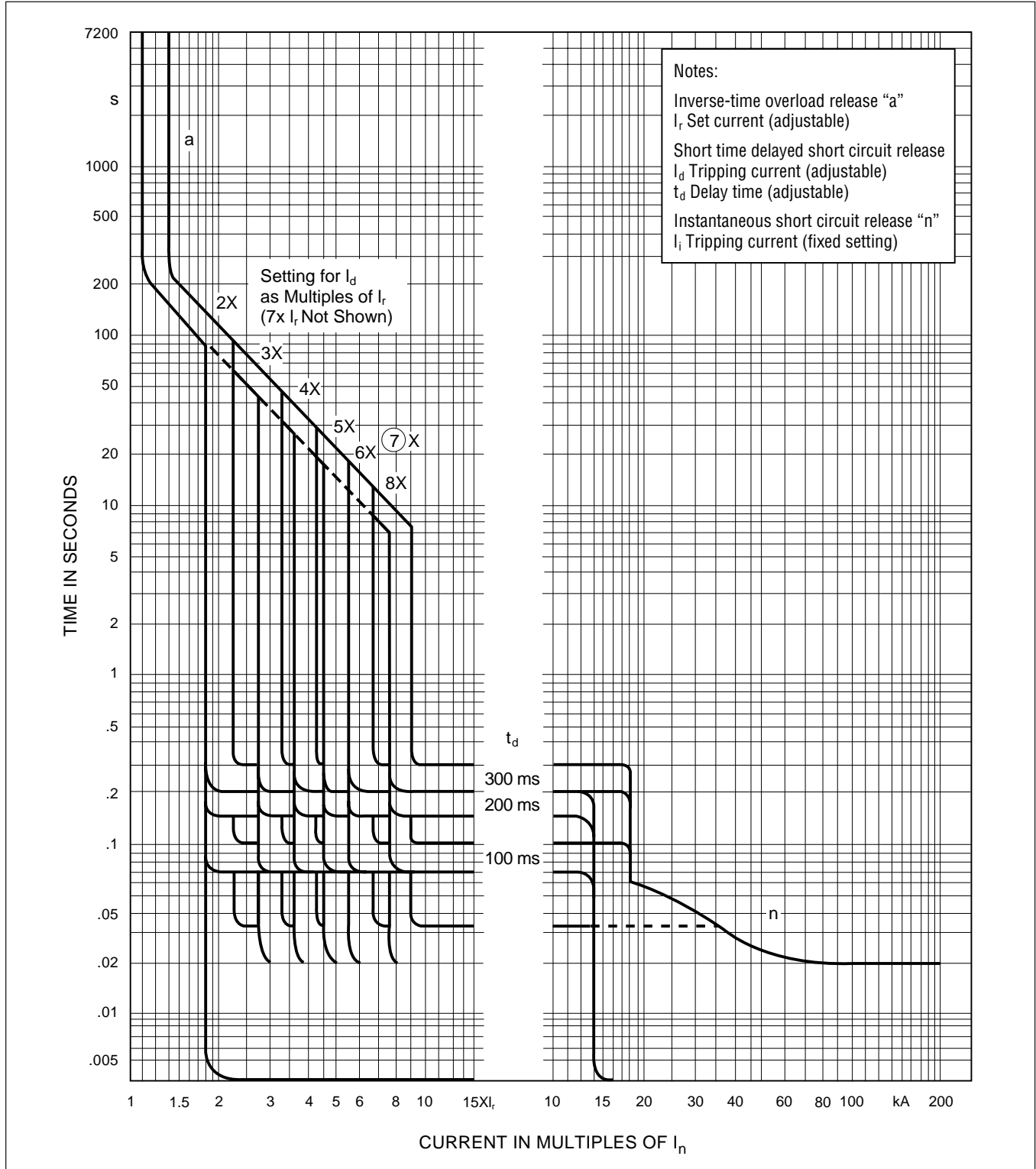

Figure 26. GN Time Current Curve for Digitrip 310 Trip Unit

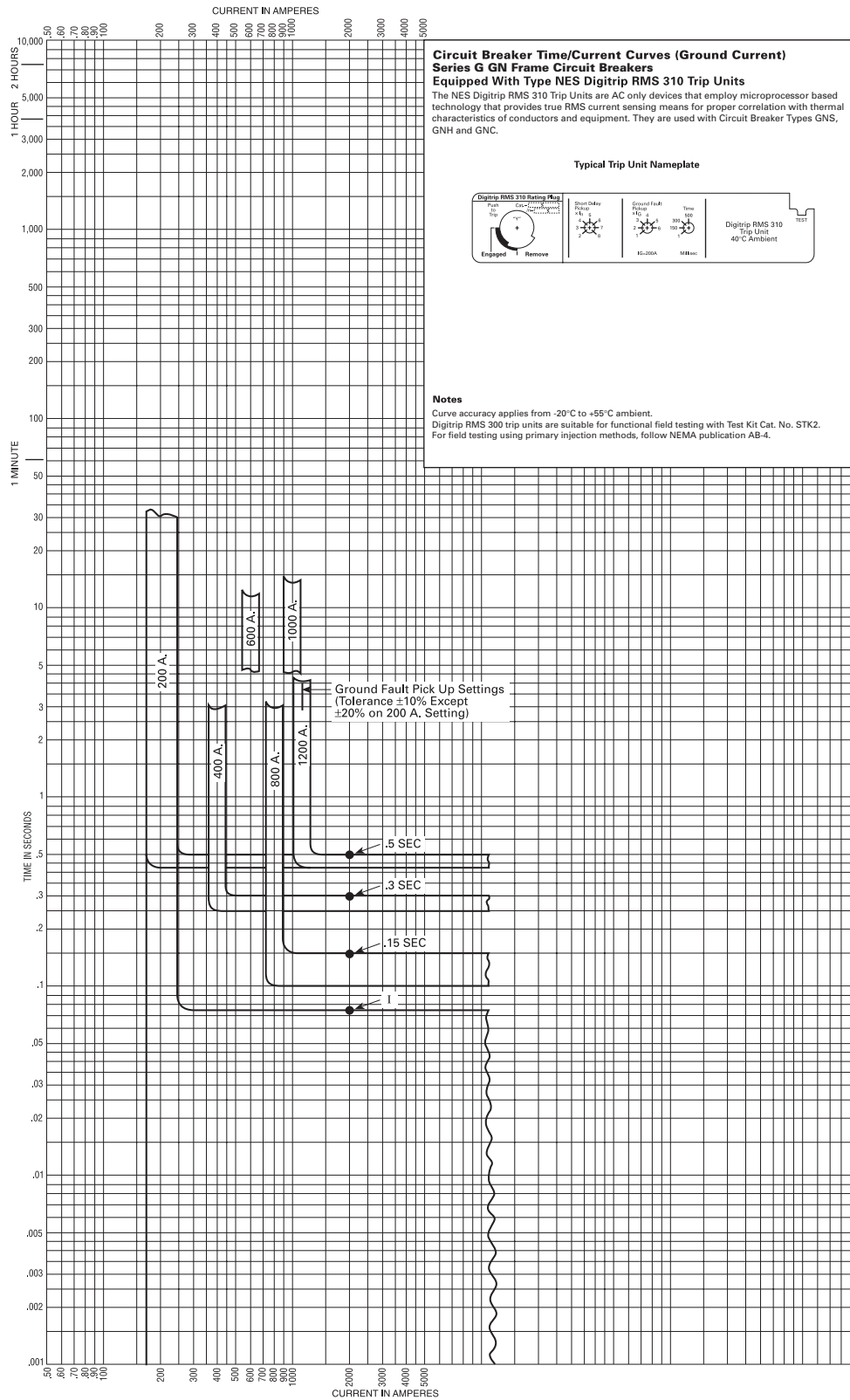

Figure 27. GN Ground Fault Delay Response Curve for Digitrip 310 Trip Unit

Type GR

Tripping characteristics of GR circuit breakers with solid-state overcurrent release.

Working Temperature Range

The tolerance bands shown are applicable to an ambient temperature range of -5 to +60°C at the circuit breaker.

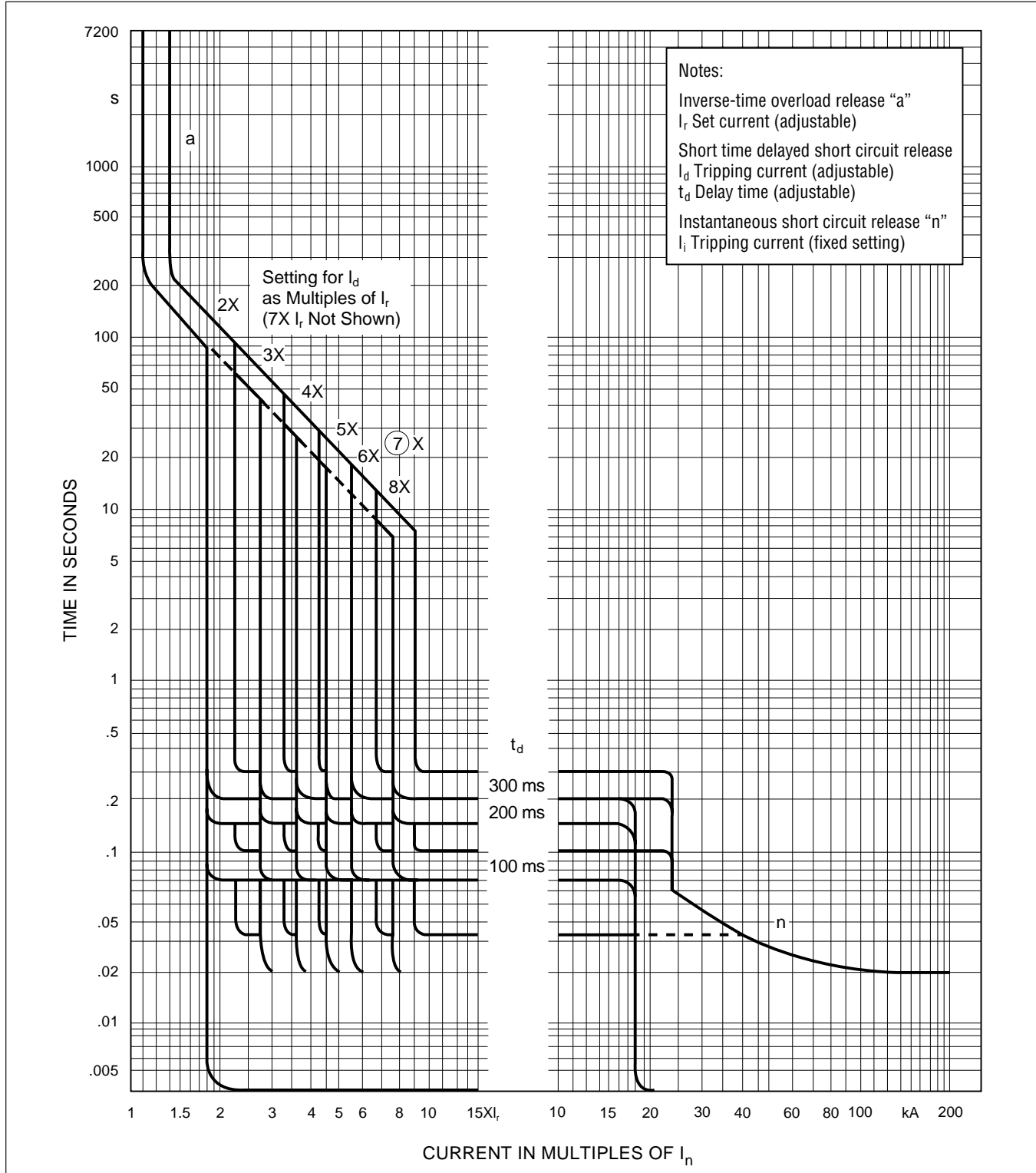

Figure 28. GR Time Current Curve for Digitrip 310 Trip Unit

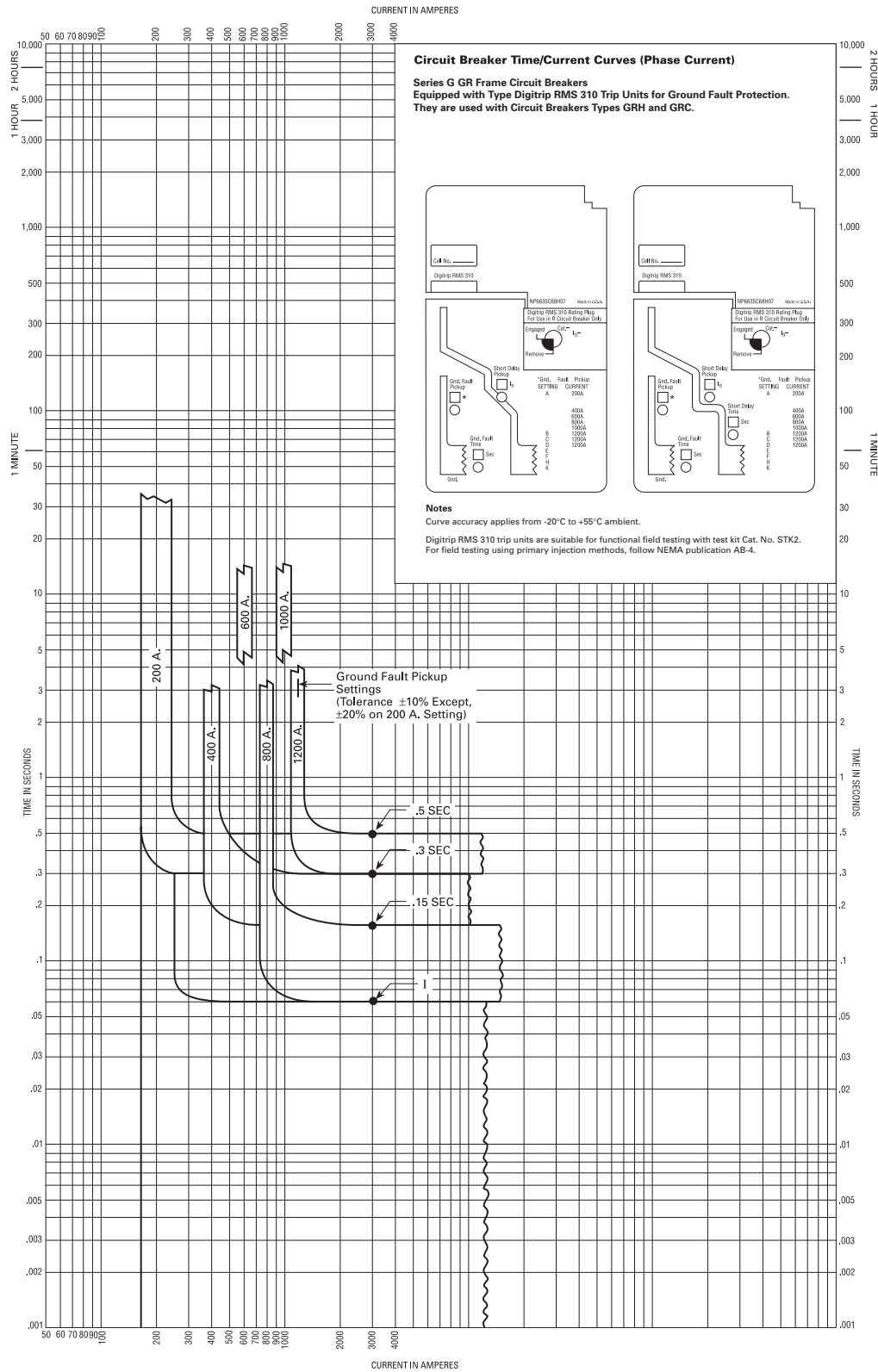

Figure 29. GR Ground Fault Delay Response Curve for Digitrip 310 Trip Unit

Frame Sizes GE through GR

Current Limiting Curves

Current Limiting Characteristics and Maximum I²t Values

Type GE/GJ/GL

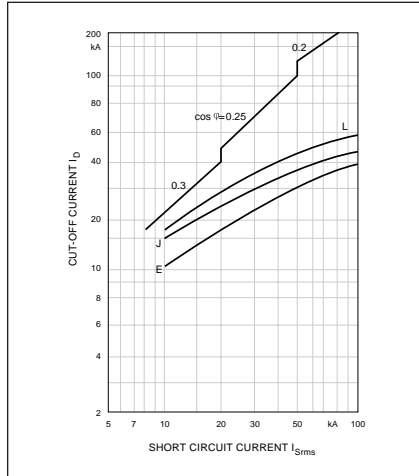

Figure 30. Current Limiting Characteristics for GE to GL, 50/60 Hz 380/415/480 Vac

Type GE/GJ/GL

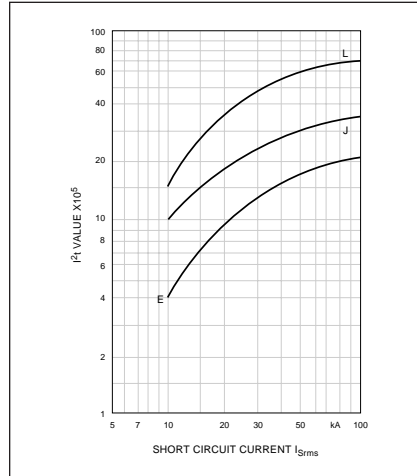

Figure 32. Maximum I²t Values for GE to GL, 50/60 Hz 380/415/480 Vac

Type GN/GR

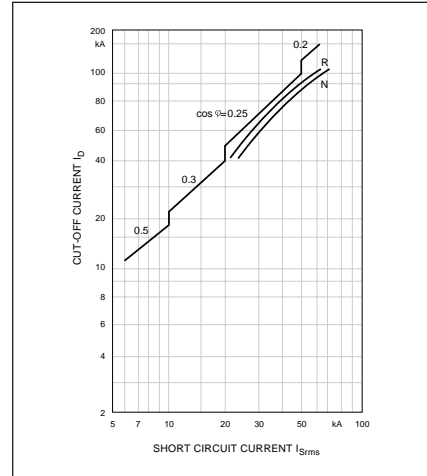

Figure 34. Current Limiting Characteristics I_b for GN to GR, 50/60 Hz 380/415/480 Vac

Type GE/GJ/GL

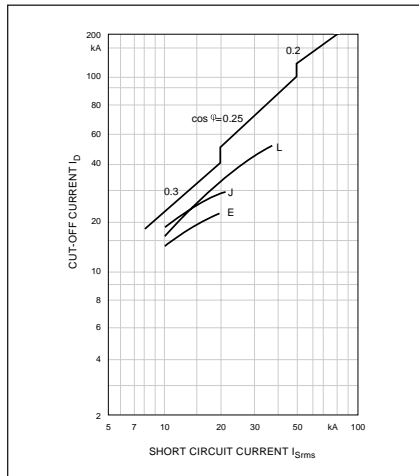

Figure 31. Current Limiting Characteristics for GE to GL, 50/60 Hz 600/660/690 Vac

Type GE/GJ/GL

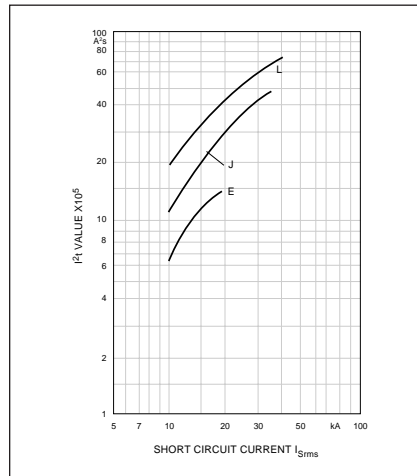

Figure 33. Maximum I²t Values for GE to GL, 50/60 Hz 600/660/690 Vac

Type GN/GR

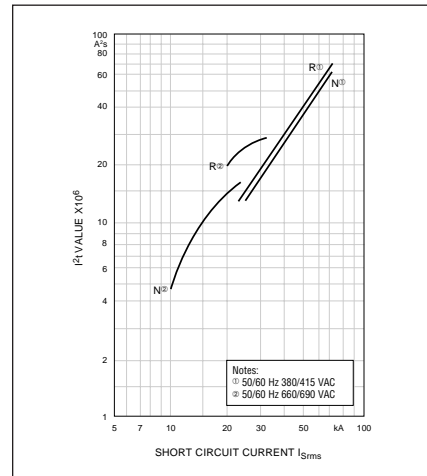

Figure 35. Maximum I²t Values for GN to GR, 50/60 Hz 600/660/690 Vac

Dimensions

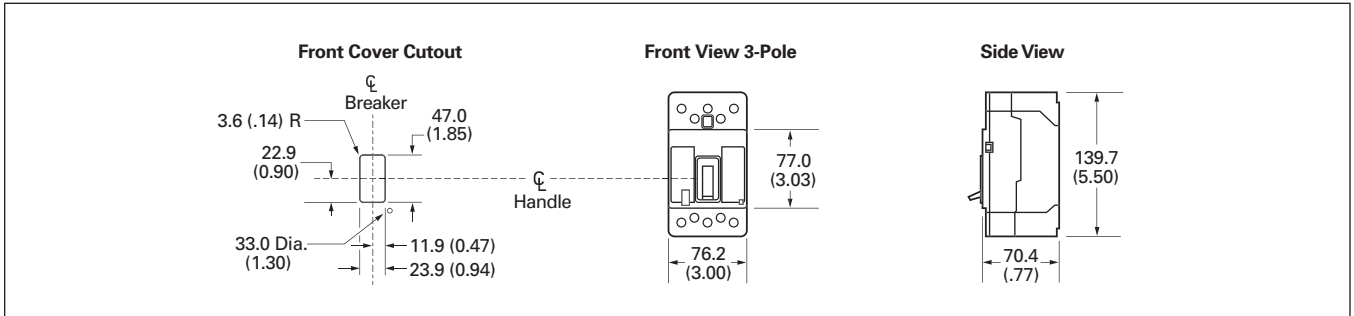

Figure 36. GE-Frame — Dimensions in mm (Inches)

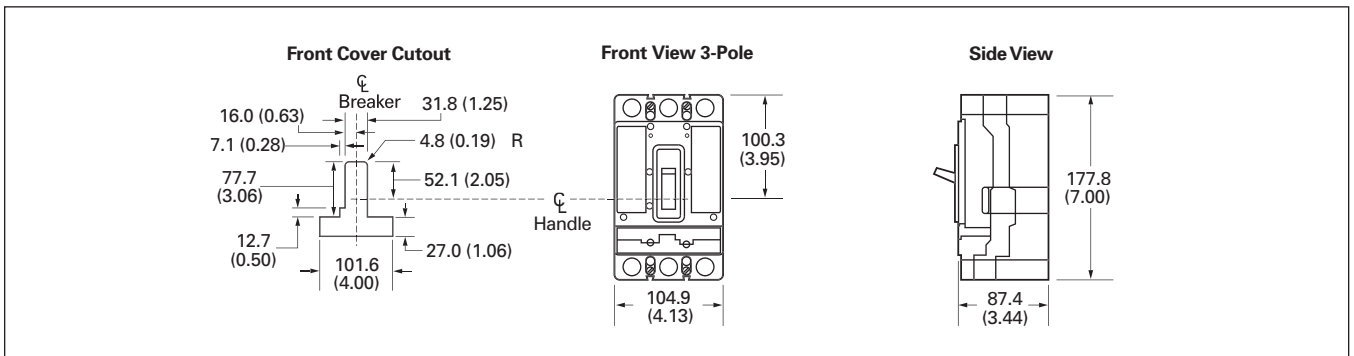

Figure 37. GJ-Frame — Dimensions in mm (Inches)

Frame Sizes GL through GR

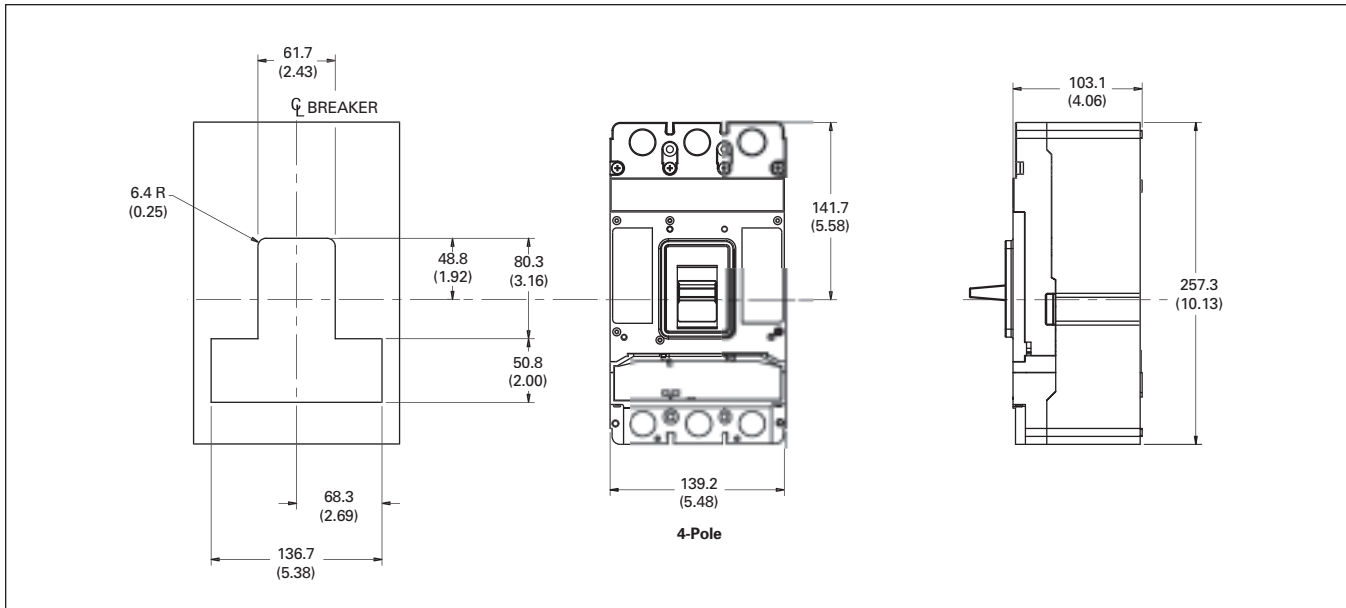

Figure 38. GL-Frame — Dimensions in mm (Inches)

Note: TA63IL, T63IL, T632L, TA632L terminals add 30.2 mm (1.19 inches) to line or load side of GL. LTS3K or LTS4K terminal covers add 54.1 mm (2.13 inches) to line or load side of GL.

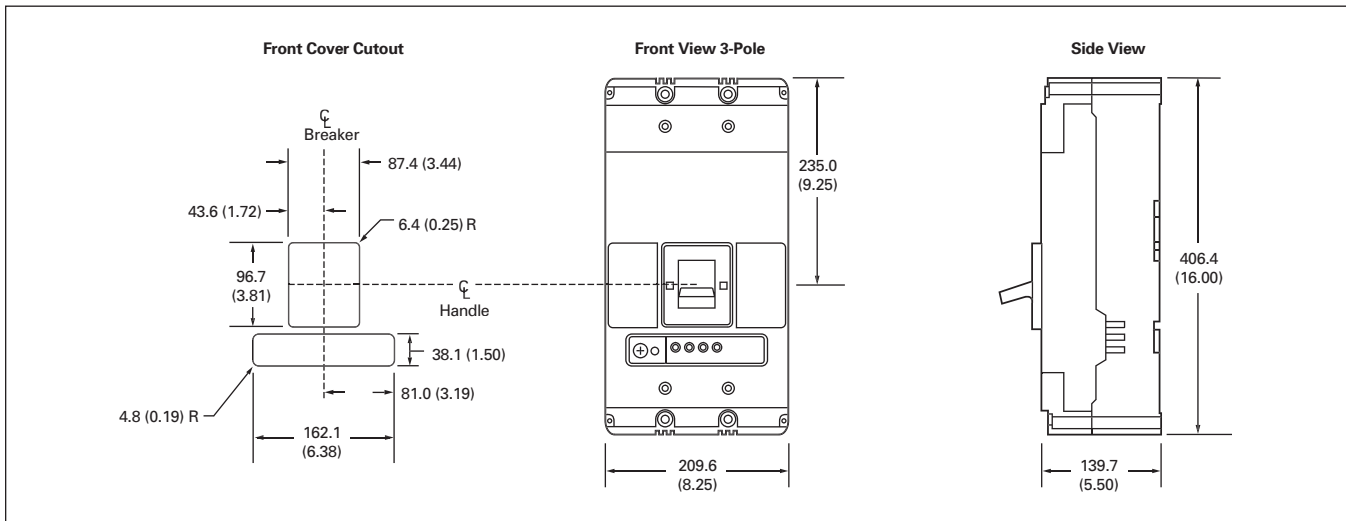

Figure 39. GN-Frame — Dimensions in mm (Inches)

September 2005
Vol. 1, Ref. No. [055]

Frame Size GR

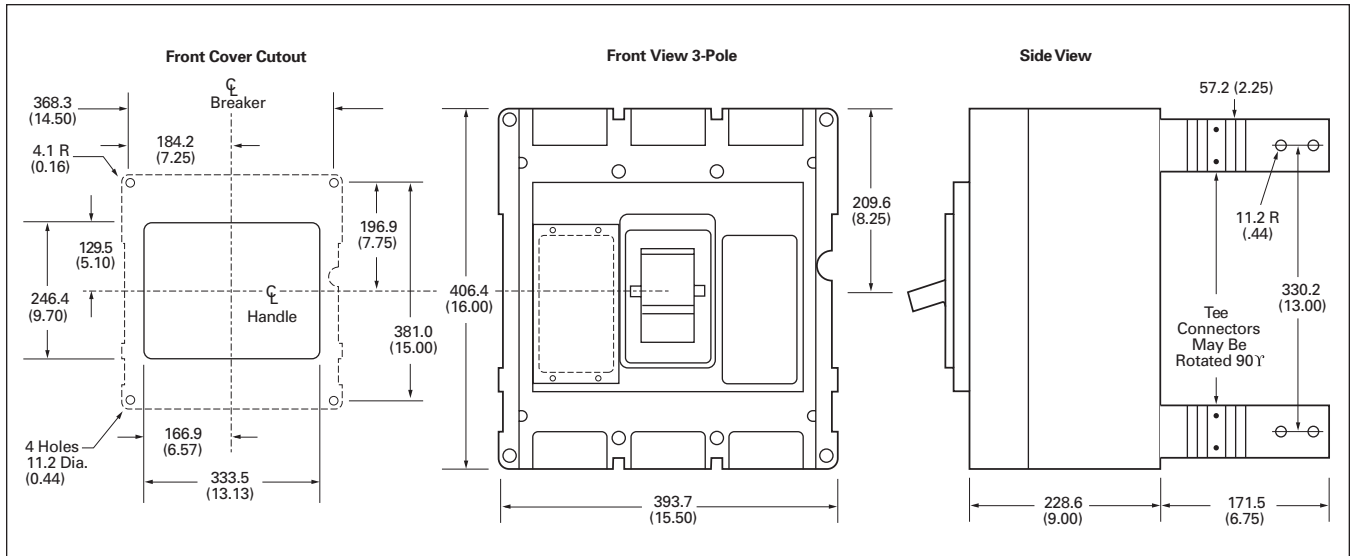

Figure 40. GR-Frame — Dimensions in mm (Inches)

Notes

Eaton's electrical business is a global leader in electrical control, power distribution, and industrial automation products and services. Through advanced product development, world-class manufacturing methods, and global engineering services and support, Eaton's electrical business provides customer-driven solutions under brand names such as Cutler-Hammer®, Powerware®, Durant®, Heinemann®, Holec® and MEM®, which globally serve the changing needs of the industrial, utility, light commercial, residential, and OEM markets. For more information, visit www.EatonElectrical.com.

Eaton Corporation is a diversified industrial manufacturer with 2004 sales of \$9.8 billion. Eaton is a global leader in electrical systems and components for power quality, distribution and control; fluid power systems and services for industrial, mobile and aircraft equipment; intelligent truck drivetrain systems for safety and fuel economy; and automotive engine air management systems, powertrain solutions and specialty controls for performance, fuel economy and safety. Eaton has 57,000 employees and sells products to customers in more than 125 countries. For more information, visit www.eaton.com.

Eaton Electrical Inc.
1000 Cherrington Parkway
Moon Township, PA 15108
United States

For more information or to locate
regional product support, please visit
us at www.EatonElectrical.com





Series G Moulded Case Circuit Breakers 15 – 2500 A for IEC & NEMA Applications

Product Focus



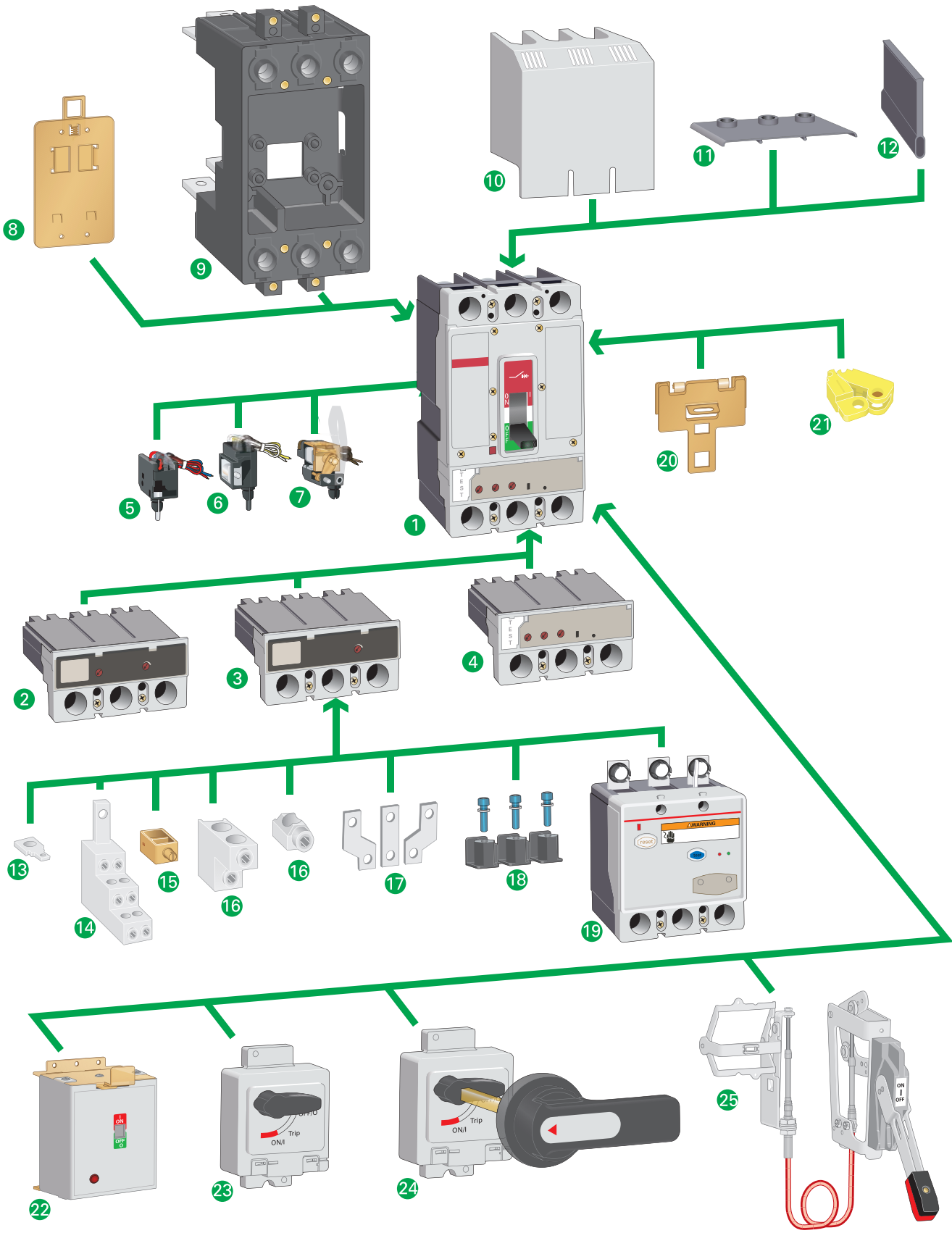

World-class accessories include: **1** Circuit breaker **2** Thermal-magnetic trip unit, integrated on E Frame **3** Magnetic only trip unit, integrated on E Frame **4** Electronic protection trip unit, J/L Frame only **5** Auxiliary/alarm contact **6** Shunt trip **7** Undervoltage release **8** DIN-rail mounting adapter, E Frame only **9** Plug-in block **10** Terminal cover **11** Terminal end cover **12** Interphase barrier **13** Control wire kit **14** Multiwire connector **15** Steel cable terminal **16** Aluminum/copper terminal **17** Terminal spreader **18** Endcap kit **19** Earth leakage module, side mounted on E Frame **20** Padlockable handle lock hasp **21** Padlockable handle block **22** Motor operator **23** Direct close coupled handle mechanism **24** Through-the-door handle mechanism **25** Flex Shaft handle mechanism

<i>Description</i>	<i>Page</i>
Standards	1
General Information	2
Typical Applications	3
Electrical Characteristics	4
Multi-Function Electronic Trip Units	10
Electronic Trip Unit Selection Guide	12
Breaker Ordering Information/ Catalogue Numbers/ Termination Accessories	
GE-Frame, 15 – 160 Amperes	13
GJ-Frame, 20 – 250 Amperes	17
GL-Frame, 100 – 630 Amperes	21
GN-Frame, 400 – 1250 Amperes	26
GN-Frame, 1600 Amperes	29
GR-Frame, 800 – 2500 Amperes	30
Motor Circuit Protectors	35
30 mA Ground Fault (Earth Leakage) Modules	36
Special Features and Accessories	37
Plug-in Blocks and Drawout Cassettes	40
Handle Mechanisms	41
Time Current Curves	44
Current Limiting Curves	52
Dimensions	53

Standards

Eaton Moulded Case Circuit Breakers from Eaton’s electrical business are designed to conform with the following international standards:

- Australian Standard AS 2184 and AS 3947-2 Moulded Case Circuit Breakers.
- British Standards Institution Standard BS 4752: Part 1, Switchgear and Control Gear Part 1, Circuit Breakers.
- International Electrotechnical Commission Recommendations IEC 60947.2 Circuit Breakers. **CE**
- Japanese T-Mark Standard Moulded Case Circuit Breakers.
- National Electrical Manufacturers Association Standards Publication No. AB1-1975 Moulded Case Circuit Breakers.
- South African Bureau of Standards, Standard SABS 156, Standard Specification for Moulded Case Circuit Breakers.
- Swiss Electro-Technical Association Standard SEV 947.2, Safety Regulations for Circuit Breakers.
- Union Technique de l’Electricite Standard NF C 63-120, Low Voltage Switchgear and Control Gear Circuit Breaker Requirements.
- Verband Deutscher Elektrotechnike (Association of German Electrical Engineers) Standard VDE 0660, Low Voltage Switchgear and Control Gear, Circuit Breakers.

Trademarks

Cutler-Hammer is a federally registered trademark of Eaton Corporation.

CSA is a registered trademark of Canadian Standards Association.

UL is a registered trademark of Underwriters Laboratories Inc.

ISO is the registered trademark and sole property of the International Organization for Standardization.

NEMA is the registered trademark and service mark of the National Electrical Manufacturers Association.

Global Third Party Certification

Certification marks ensure product compliance with the total standard via the third party witnessing of tests by globally recognized independent certification organizations.

KEMA is a highly recognized, independent international organization that offers certification and inspection facilities for equipment in many industries. The KEMA-KEUR mark is the highest certification an electrical product can receive from KEMA. Our IEC 60947-2 Moulded Case Circuit Breakers are KEMA tested and certified. These breakers are also listed in accordance with UL® 489, as well as CSA C22.2 No. 5-02.

KEMA and UL provide ongoing follow-up testing and inspections to ensure that Eaton Moulded Case Circuit Breakers continue to meet their exacting standards.

Note: The Eaton Series G Frames GE, GJ, GL, GN and GR, although they are UL and CSA approved, do not carry the UL and CSA labels on the breakers. For applications that require UL/CSA labels, please contact your Eaton representative.

General Information

Eaton Series G Moulded Case Circuit Breakers provide increased performance in considerably less space than standard circuit breakers or comparable fusible devices.

The “G” signifies global applications: Series G circuit breakers are marked with UL, CSA®, CE, IEC and KEMA KEUR listings. Other advantages include:

- Field-fit accessories.
- Common accessories through 630 amperes.
- Electronic trip units from 20 to 2500 amperes.
- UL-listed and IEC-rated, 30 mA ground fault/earth leakage modules.
- Built-in ground fault protection down to 20 amperes.

The GE, GJ and GL frames are new circuit breakers designed around space-saving footprints. The GN and GR use the proven Cutler-Hammer Series C® ND and RD designs but use metric threading on their line and load conductors.

Eaton Series G Circuit Breakers meet applicable UL 489 and IEC 60947-2 standards.

The Eaton Series G family includes five frame sizes in ratings from 15 to 2500 amperes. Series G offers a choice of several interrupting capacities up to 100 kA at 480 volts ac (200 kA at 240 volts ac).

Standard calibration is 40°C. For applications in high ambient temperature conditions, 50°C factory calibration is available on thermal magnetic breakers.

The Most Logically Designed Contact Assembly

The flexibility and outstanding performance characteristics of Eaton Circuit Breakers are made possible by the best contact designs in circuit breaker history. Our patented technology creates a high-speed “blow-open” action using the electromechanical forces produced by high-level fault currents.

Eaton Circuit Breakers are operated by a toggle-type mechanism that is mechanically trip-free from the handle so that the contacts cannot be held closed against short circuit currents. Tripping due to overload or short circuits is clearly indicated by the position on the handle. This remarkably fast and dependable contact action is designed to enhance safety.

Thorough In-Plant Testing

The quality, dependability and reliability of every Eaton Circuit Breaker is ensured by a thorough program of in-plant testing. Two calibration tests are conducted on every pole of every circuit breaker to verify the trip mechanism, operating mechanism, continuity and accuracy.

ISO Certification

Eaton Circuit Breakers are manufactured in ISO® certified facilities.

Current Limiting Characteristics

Eaton Series G Circuit Breakers are current limiting because of their high repulsion contact arrangement and use of state-of-the-art arc extinguishing technology.

Operating Mechanisms

Eaton Circuit Breakers have a toggle handle operating mechanism, which also serves as a switching position indicator. The indicator shows the positions of: ON, OFF and TRIPPED.

The toggle handle snaps into the TRIPPED position if the breaker is tripped by one of its overcurrent, short circuit, shunt or undervoltage releases. Before the circuit breaker can be reclosed following a trip-out, the toggle handle must be brought beyond the OFF position (RESET). The circuit breaker can then be reclosed.

As an additional switching position indicator for GE- to GR-Frame circuit breakers, there are two windows on the right and on the left of the toggle handle, in which the switching state is indicated by means of the colors red, green and white corresponding to the ON, OFF and TRIPPED positions respectively.

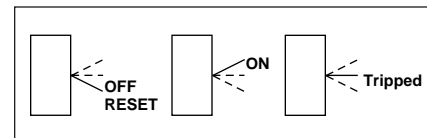

Figure 1. Positions of the Toggle Handle Drive

Typical Applications

Machine Tool Control Panels and Motor Control Centers

Designed for these equipment requirements, including new world-class accessories.

Panelboards

As both main and branch circuit protection devices.

Feeder Pillars

In distribution systems to provide main and branch circuit protection.

Switchgear

In distribution systems to provide main and branch circuit protection up to 2500 amperes (GR-Frame).

Bus Bar Trunking Tap-Offs

In bus bar trunking tap-offs to provide circuit protection.

Individual Enclosures

Completely assembled in enclosures to meet specific customer requirements.

Additional Applications

Special versions of each Cutler-Hammer frame are available to provide safe equipment control and protection in mining and other applications. Contact your Eaton agent or distributor for additional information.

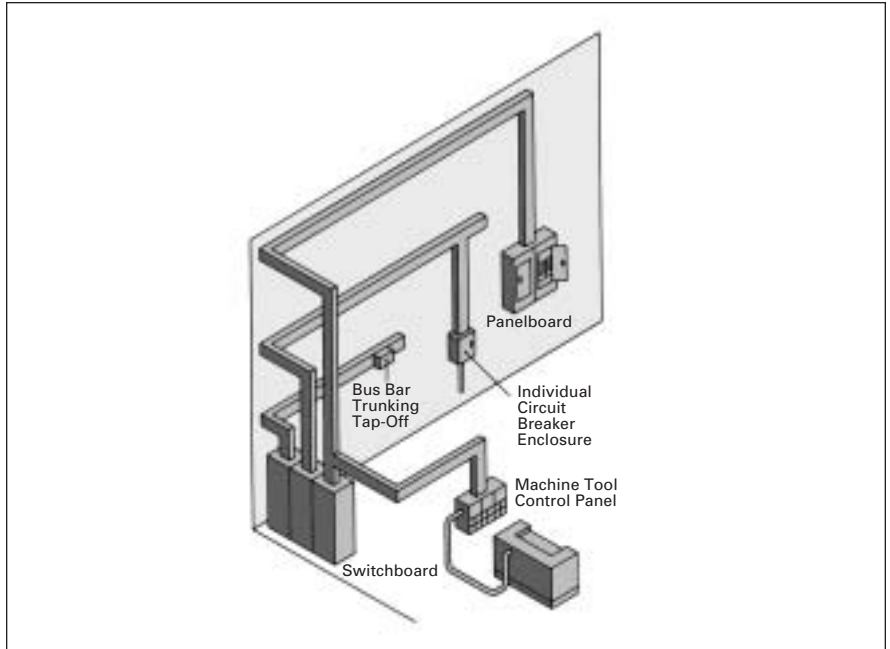

Figure 2. Typical Eaton Applications

Table 1. Typical Eaton Applications

Frame	Continuous Ampere Rating Range	Trip Unit Type					Moulded Case Switch
		Adjustable Thermal Fixed Magnetic	Fixed Thermal Fixed Magnetic	Adjustable Thermal Adjustable Magnetic	30 mA Ground Fault/Earth Leakage	Digitrip™ RMS Electronic Trip Units	
E	15 – 160 ①	■	■	—	■	—	■
J	20 – 250	—	—	■	■	■	■
L	100 – 630 ②	—	—	■	■	■	■
N	400 – 1600 ③	—	—	—	—	■	■
R	800 – 2500	—	—	—	—	■	■

① 125 amperes is the maximum NEMA rating for the GE.

② 630 amperes is not NEMA rated. 600 amperes is the maximum NEMA rating for the GL.

③ 1200 amperes is the maximum NEMA rating for the GN.

Frame Sizes GE through GL

Electrical Characteristics

Table 2. Electrical Characteristics

Maximum Rated Current (Amperes)		GE								GJ				GL					
		125, 160 ^①								250				400, 630 ^②					
Breaker Type		B		E		S		H		E	S	H	C	E	S	H	C		
Number of Poles		1	2, 3, 4 ^③		2, 3, 4 ^③		1	2, 3, 4 ^③		1	2, 3, 4 ^③		2, 3, 4 ^③		3, 4 ^③				
Breaker Capacity (kA rms) ac 50 – 60 Hz																			
NEMA®, UL, CSA	240 Vac	25	25	35	85	85	100	100	65	85	100	200	65	85	100	200			
	480 Vac	—	18	25	—	35	—	65	25	35	65	100	35	50	65	100			
	600 Vac	—	—	—	—	—	—	—	18	25	35	50	18	25	35	50			
	250 Vdc ^④	10	10	10	35	35	42	42	10	35	42	42	22	22	42	42			
IEC 60947-2	220 – 240 Vac	I _{CU}	25	25	35	85	85	100	100	65	85	100	200	65	85	100	200		
		I _{CS}	25	25	35	43	43	50	50	65	85	100	150	65	85	100	150		
	380 – 415 Vac	I _{CU}	—	18	25	—	40	—	70	25	40	70	100	35	50	70	100		
		I _{CS}	—	18	25	—	30	—	35	25	40	70	75	35	50	70	75		
	660 – 690 Vac	I _{CU}	—	—	3	—	4	—	6	12	12	14	20	12	20	25	35		
		I _{CS}	—	—	3	—	3	—	3	6	6	7	10	6	10	13	18		
	250 Vdc ^④	I _{CU}	10	10	10	35	35	42	42	10	35	42	42	22	22	42	42		
		I _{CS}	10	10	10	35	35	42	42	10	35	42	42	22	22	42	42		
Ampere Range		15 – 160 A ^①								20 – 250 A				100 – 630 A ^②					
Trip Units F= Fixed A= Adjustable T= Thermal M= Magnetic		FT-FM AT-FM								FT-AM AT-AM Electronic (Digitrip RMS 310)				FT-AM AT-AM Electronic (Digitrip RMS 310)					
Interchangeable		—								■				■					
Built-in		■								■				■					
Thermal Magnetic	Fixed Thermal	■								■				■					
	Adjustable Thermal	■								■				■					
	Magnetic	Fixed								Adjustable				Adjustable					
Electronic rms ^⑤	LS	—								■				■ ^④					
	LSI	—								■				■ ^④					
	LSG	—								■				■ ^④					
	LSIG	—								■				■ ^④					
Dimensions mm (Inches)	1-Pole	H		W		D		H		W		D		H		W		D	
	2-Pole	139.7 (5.50)		25.4 (1.00)		76.0 (2.99)		—		—		—		—		—		—	
	3-Pole			50.8 (2.00)				177.8 (7.00)		105.0 (4.13)		87.4 (3.57)		258.0 (10.13)		140.0 (5.48)		104.0 (4.09)	
	4-Pole			76.2 (3.00)						135.6 (5.34)						183.0 (7.22)			
Weight (approximate) kg (lbs.)		1-Pole		2-Pole		3-Pole		4-Pole		2-Pole		3-Pole		4-Pole		3-Pole		4-Pole	
		0.5 (1.1)		0.9 (2.0)		1.4 (3.1)		1.8 (3.9)		5.2 (11.4)		5.2 (11.4)		7.0 (15.3)		7.3 (16.0)		9.1 (20.0)	
Utilization Category		A								A				A					

^① 125 amperes is the maximum NEMA rating for the GE.



^② 630 amperes is not NEMA rated. 600 amperes is the maximum NEMA rating for the GL.

^③ Neutral on left side.

^④ Two poles in series.

^⑤ Not suitable for dc application. 4-pole ground fault not available with neutral protection.

Table 2. Electrical Characteristics (Continued)

Maximum Rated Current (Amperes)	GN ①					GR ①		
								
	800, 1250			1600 ②		1600, 2000, 2500		
Breaker Type	S	H	C ③		S	H	H	C ③
Number of Poles	2, 3, 4 ④				2, 3, 4 ④		3, 4 ④	

Breaker Capacity (kA rms) ac 50 – 60 Hz

NEMA, UL, CSA	240 Vac		65	100	200	—	—	125	200	
	480 Vac		50	65	100	—	—	65	100	
	600 Vac		25	35	50	—	—	50	65	
IEC 60947-2	220 – 240 Vac	<i>I_{cu}</i>	85	100	200	85	100	135	200	
		<i>I_{cs}</i>	85	100	100	85	100	100	100	
	380 – 415 Vac	<i>I_{cu}</i>	50	70	100	50	70	70	100	
		<i>I_{cs}</i>	50	50	50	50	50	50	50	
	660 – 690 Vac	<i>I_{cu}</i>	20 ⑤	25 ⑤	35	20 ⑤	25	25 ⑤	35 ⑤	
		<i>I_{cs}</i>	10	13	18	10	13	13	18	
250 Vdc	<i>I_{cu}</i>	—	—	—	—	—	—	—		
	<i>I_{cs}</i>	—	—	—	—	—	—	—		
Ampere Range	400 – 1250 A				1600 A		800 – 2500 A			
Trip Units	Electronic (Digitrip RMS 310)								Electronic (Digitrip RMS 310, 610 and 910)	
	Interchangeable		—						—	
Built-in		■						■		
Electronic ⑥	LI		—						■ ⑦	
	LS		■						■	
	LSI		■						■	
	LIG		—						■ ⑦	
	LSG		■						■	
	LSIG		■						■	
Dimensions mm (Inches)	1-Pole		H	W	D		H	W	D	
	2-Pole		—	—	—		—	—	—	
	3-Pole		406.0 (16.00)	210.0 (8.25)	140.0 (5.50)		406.0 (16.00)	394.0 (15.50)	229.0 (9.75)	
	4-Pole		—	280.0 (11.13)	—		—	508.0 (20.00)	—	
Weight (approximate) kg (lbs.)	3-Pole		4-Pole		3-Pole		4-Pole			
	21.3 (46.8)		28.3 (62.0)		47.0 (103.0)		54.0 (118.4)			
Utilization Category		A				A				

- ① The GN and GR MCCBs use metric threading in their line and load terminals. If English (Imperial) threading is needed, use Series C ND and RD MCCBs. Contact Eaton for more information.
- ② GN 1600 ampere frame is not NEMA rated.
- ③ Not KEMA-KEUR listed.
- ④ Neutral on right side.
- ⑤ IEC 60947-2 H.5 Annex H is not KEMA-KEUR tested.
- ⑥ Not suitable for dc application. 4-pole ground fault not available with neutral protection.
- ⑦ Available only on Digitrip 610 and 910 trip units.

Frame Sizes GE through GR

Table 3. GE through GR Electrical Characteristics

Technical Data	GE	GJ	GL	GN	GR																																																																																																																																																																																																																									
Maximum Rated Current I_n Depending on the Version	160 A ^①	250 A	400, 630 A ^②	800, 1200, 1600 A ^③	1600, 2000, 2500 A																																																																																																																																																																																																																									
Rated Insulation Voltage U, According to IEC 60947-2 Main Conducting Paths Auxiliary Circuits	690 Vac 690 Vac	750 Vac 690 Vac	750 Vac 690 Vac	750 Vac 690 Vac	750 Vac 690 Vac																																																																																																																																																																																																																									
Rated Impulse Withstand Voltage U_{imp} Main Conducting Paths Auxiliary Circuits	6 kV 4 kV	8 kV 4 kV	8 kV 4 kV	8 kV 4 kV	8 kV 4 kV																																																																																																																																																																																																																									
Rated Operational Voltage U_e IEC NEMA	690 Vac 600 Y/347 Vac	690 Vac 600 Vac	690 Vac 600 Vac	690 Vac 600 Vac	690 Vac 600 Vac																																																																																																																																																																																																																									
UL and CSA Listed	Yes ^④	Yes ^④	Yes ^④	Yes ^④	Yes ^④																																																																																																																																																																																																																									
Permissible Ambient Temperature	-20 to +70°C	-20 to +70°C	-20 to +70°C	-5 to +60°C	-5 to +60°C																																																																																																																																																																																																																									
Permissible Load for Various Ambient Temperatures Close to the Circuit Breaker, Related to the Rated Current of the Circuit Breaker	<table border="1"> <thead> <tr> <th rowspan="2"></th> <th colspan="2">⑤</th> <th colspan="2">⑥</th> <th colspan="2">⑤</th> <th colspan="2">⑥</th> <th rowspan="2">—</th> <th rowspan="2">—</th> </tr> <tr> <th>⑤</th> <th>⑥</th> <th>⑤</th> <th>⑥</th> <th>⑤</th> <th>⑥</th> <th>⑤</th> <th>⑥</th> </tr> </thead> <tbody> <tr> <td>■ Circuit Breakers for Plant Protection</td> <td colspan="10"></td> </tr> <tr> <td>– At 40°C</td> <td>100%</td> <td>100%</td> <td>100%</td> <td>100%</td> <td>100%</td> <td>100%</td> <td>100%</td> <td>100%</td> <td>100%</td> <td>100%</td> </tr> <tr> <td>– At 50°C</td> <td>96%</td> <td>92%</td> <td>96%</td> <td>94%</td> <td>96%</td> <td>91%</td> <td>91%</td> <td>91%</td> <td>91%</td> <td>91%</td> </tr> <tr> <td>– At 55°C</td> <td>93%</td> <td>87%</td> <td>94%</td> <td>90%</td> <td>93%</td> <td>86%</td> <td>85%</td> <td>85%</td> <td>85%</td> <td>85%</td> </tr> <tr> <td>– At 60°C</td> <td>91%</td> <td>83%</td> <td>92%</td> <td>87%</td> <td>90%</td> <td>82%</td> <td>81%</td> <td>81%</td> <td>81%</td> <td>81%</td> </tr> <tr> <td>– At 70°C</td> <td>86%</td> <td>73%</td> <td>88%</td> <td>80%</td> <td>84%</td> <td>70%</td> <td>—</td> <td>—</td> <td>—</td> <td>—</td> </tr> <tr> <td>■ Circuit Breakers for Motor Protection</td> <td colspan="10"></td> </tr> <tr> <td>– At 40°C</td> <td>—</td> <td>—</td> <td>100%</td> <td>—</td> <td>100%</td> <td>—</td> <td>—</td> <td>—</td> <td>—</td> <td>—</td> </tr> <tr> <td>– At 50°C</td> <td>—</td> <td>—</td> <td>100%</td> <td>—</td> <td>100%</td> <td>—</td> <td>—</td> <td>—</td> <td>—</td> <td>—</td> </tr> <tr> <td>– At 55°C</td> <td>—</td> <td>—</td> <td>100%</td> <td>—</td> <td>100%</td> <td>—</td> <td>—</td> <td>—</td> <td>—</td> <td>—</td> </tr> <tr> <td>– At 60°C</td> <td>—</td> <td>—</td> <td>100%</td> <td>—</td> <td>100%</td> <td>—</td> <td>—</td> <td>—</td> <td>—</td> <td>—</td> </tr> <tr> <td>– At 70°C</td> <td>—</td> <td>—</td> <td>90%</td> <td>—</td> <td>90%</td> <td>—</td> <td>—</td> <td>—</td> <td>—</td> <td>—</td> </tr> <tr> <td>■ Circuit Breakers for Starter Combinations and Isolating Circuit Breakers</td> <td colspan="10"></td> </tr> <tr> <td>– At 40°C</td> <td>100%</td> <td>—</td> <td>100%</td> <td>—</td> <td>100%</td> <td>—</td> <td>100%</td> <td>—</td> <td>100%</td> <td>—</td> </tr> <tr> <td>– At 50°C</td> <td>100%</td> <td>—</td> <td>100%</td> <td>—</td> <td>100%</td> <td>—</td> <td>91%</td> <td>—</td> <td>91%</td> <td>—</td> </tr> <tr> <td>– At 55°C</td> <td>96%</td> <td>—</td> <td>96%</td> <td>—</td> <td>95%</td> <td>—</td> <td>85%</td> <td>—</td> <td>85%</td> <td>—</td> </tr> <tr> <td>– At 60°C</td> <td>91%</td> <td>—</td> <td>82%</td> <td>—</td> <td>90%</td> <td>—</td> <td>81%</td> <td>—</td> <td>81%</td> <td>—</td> </tr> <tr> <td>– At 70°C</td> <td>86%</td> <td>—</td> <td>88%</td> <td>—</td> <td>84%</td> <td>—</td> <td>—</td> <td>—</td> <td>—</td> <td>—</td> </tr> </tbody> </table>						⑤		⑥		⑤		⑥		—	—	⑤	⑥	⑤	⑥	⑤	⑥	⑤	⑥	■ Circuit Breakers for Plant Protection											– At 40°C	100%	100%	100%	100%	100%	100%	100%	100%	100%	100%	– At 50°C	96%	92%	96%	94%	96%	91%	91%	91%	91%	91%	– At 55°C	93%	87%	94%	90%	93%	86%	85%	85%	85%	85%	– At 60°C	91%	83%	92%	87%	90%	82%	81%	81%	81%	81%	– At 70°C	86%	73%	88%	80%	84%	70%	—	—	—	—	■ Circuit Breakers for Motor Protection											– At 40°C	—	—	100%	—	100%	—	—	—	—	—	– At 50°C	—	—	100%	—	100%	—	—	—	—	—	– At 55°C	—	—	100%	—	100%	—	—	—	—	—	– At 60°C	—	—	100%	—	100%	—	—	—	—	—	– At 70°C	—	—	90%	—	90%	—	—	—	—	—	■ Circuit Breakers for Starter Combinations and Isolating Circuit Breakers											– At 40°C	100%	—	100%	—	100%	—	100%	—	100%	—	– At 50°C	100%	—	100%	—	100%	—	91%	—	91%	—	– At 55°C	96%	—	96%	—	95%	—	85%	—	85%	—	– At 60°C	91%	—	82%	—	90%	—	81%	—	81%	—	– At 70°C	86%	—	88%	—	84%	—	—	—	—	—
	⑤		⑥		⑤		⑥		—	—																																																																																																																																																																																																																				
	⑤	⑥	⑤	⑥	⑤	⑥	⑤	⑥																																																																																																																																																																																																																						
■ Circuit Breakers for Plant Protection																																																																																																																																																																																																																														
– At 40°C	100%	100%	100%	100%	100%	100%	100%	100%	100%	100%																																																																																																																																																																																																																				
– At 50°C	96%	92%	96%	94%	96%	91%	91%	91%	91%	91%																																																																																																																																																																																																																				
– At 55°C	93%	87%	94%	90%	93%	86%	85%	85%	85%	85%																																																																																																																																																																																																																				
– At 60°C	91%	83%	92%	87%	90%	82%	81%	81%	81%	81%																																																																																																																																																																																																																				
– At 70°C	86%	73%	88%	80%	84%	70%	—	—	—	—																																																																																																																																																																																																																				
■ Circuit Breakers for Motor Protection																																																																																																																																																																																																																														
– At 40°C	—	—	100%	—	100%	—	—	—	—	—																																																																																																																																																																																																																				
– At 50°C	—	—	100%	—	100%	—	—	—	—	—																																																																																																																																																																																																																				
– At 55°C	—	—	100%	—	100%	—	—	—	—	—																																																																																																																																																																																																																				
– At 60°C	—	—	100%	—	100%	—	—	—	—	—																																																																																																																																																																																																																				
– At 70°C	—	—	90%	—	90%	—	—	—	—	—																																																																																																																																																																																																																				
■ Circuit Breakers for Starter Combinations and Isolating Circuit Breakers																																																																																																																																																																																																																														
– At 40°C	100%	—	100%	—	100%	—	100%	—	100%	—																																																																																																																																																																																																																				
– At 50°C	100%	—	100%	—	100%	—	91%	—	91%	—																																																																																																																																																																																																																				
– At 55°C	96%	—	96%	—	95%	—	85%	—	85%	—																																																																																																																																																																																																																				
– At 60°C	91%	—	82%	—	90%	—	81%	—	81%	—																																																																																																																																																																																																																				
– At 70°C	86%	—	88%	—	84%	—	—	—	—	—																																																																																																																																																																																																																				
Rated Short Circuit Breaking Capacity (dc) Not for Circuit Breakers for Motor Protection (Time Constant $\tau = 10$ rms) 2 Conducting Paths in Series For GE to GL up to 250 Vdc NEMA (Time Constant $\tau = 8$ rms) 2 Conducting Paths in Series 250 Vdc	42 kA Max. 42 kA Max.	42 kA Max. 42 kA Max.	42 kA Max. 42 kA Max.	⑦ ⑦ ⑦	⑦ ⑦ ⑦																																																																																																																																																																																																																									
Main Switch Characteristics According to IEC 60947-2 in Combination with Lockable Rotary Drives	Yes	Yes	Yes	Yes	Yes																																																																																																																																																																																																																									
Rated Short Circuit Breaking Capacity According to IEC 60947-2 (at ac 50/60 Hz)	Rated Short Circuit Breaking Capacity See Table 2 on Page 4																																																																																																																																																																																																																													
Endurance (Operating Cycles)	10,000	10,000	8,000	3,000	3,000																																																																																																																																																																																																																									
Maximum Switching Frequency	300 1/h	240 1/h	240 1/h	60 1/h	20 1/h																																																																																																																																																																																																																									

① 125 amperes is the maximum NEMA rating for the GE.

② 630 amperes is not NEMA rated. 600 amperes is the maximum NEMA rating for the GL.

③ 1200 amperes is the maximum NEMA rating for the GN.

④ See footnotes for exceptions.

⑤ Thermal overload release set to the lower value.

⑥ Thermal overload release set to the upper value.

⑦ Not suitable for dc switching.

Table 3. GE through GR Electrical Characteristics (Continued)

Technical Data	GE	GJ	GL	GN	GR	
Conductor Cross Sections and Terminal Types for Main Conductors ■ Solid or Stranded ■ Finely Stranded with End Sleeve ■ Bus Bar Tightening Torque for Box Terminals Tightening Torque for Bus Bar Connection Pieces	Box Terminals 2.5 to 95 mm ² 2.5 to 50/70 mm ² — 5.6 Nm 5.6 Nm	Box Terminals 50 to 150 mm ² 35 to 120 mm ² — 20 Nm 15 Nm	Box Terminals 95 to 240 mm ² 70 to 150 mm ² — 42 Nm 30 Nm	Flat Bar Terminals — — 600 A 31 Nm 6 Nm	Flat Bar Terminals — — Optional 31 Nm 50 Nm	Flat Bar Terminals — — Optional — 20 Nm
Conductor Cross Sections for Auxiliary Circuits with Terminal Connection or Terminal Strip ■ Solid ■ Finely Stranded with End Sleeve ■ With Brought-out Cable Ends ■ Tightening Torque for Fitting Screws	0.75 to 2.5 mm ² 0.75 to 2.5 mm ²	0.75 to 2.5 mm ² 0.75 to 2.5 mm ² 0.82 (AWG 18) mm ² 0.8 to 1.4 Nm	0.75 to 2.5 mm ² 0.75 to 2.5 mm ² 0.82 (AWG 18) mm ² 0.8 to 1.4 Nm	Up to 2x4 mm ² Up to 2x2.5 mm ² 0.82 (AWG 18) mm ² 0.8 to 1.4 Nm	Up to 2x4 mm ² Up to 2x2.5 mm ² 0.82 (AWG 18) mm ² 0.8 to 1.4 Nm	
Power Loss per Circuit Breaker at Maximum Rated Current I_n (The Power Losses of the Undervoltage Releases ("r" Releases) Must Be Observed if Necessary) at Three-Phase Symmetrical Load) ■ For Plant Protection ■ As Isolating Circuit Breaker ■ For Starter Combinations ■ For Motor Protection	50 W 40 W 40 W —	75 W 75 W 45 W 75 W	255 W 160 W 160 W 120 W	87/210 W 87/210 W — —	220/270/400 W 220/270/400 W — —	
Permissible Mounting Position						
Arc Spacing — Suitable for Reverse-Feed Applications	Yes (Except HMCPE)	Yes	Yes	Yes	Yes	

Frame Sizes GE through GR
Table 3. GE through GR Electrical Characteristics (Continued)

Technical Data	GE	GJ	GL	GN	GR
Auxiliary Switches					
Rated Thermal Current I_{th} Rated Making Capacity	6 A 20 A	6 A 20 A	6 A 20 A	6 A 20 A	6 A 20 A
ac (ac-15) <ul style="list-style-type: none"> ■ Rated Operational Voltage ■ Rated Operational Current 	230/400/600 V 6/3/0.25 A	230/400/600 V 6/3/0.25 A	230/400/600 V 6/3/0.25 A	600 V 6 A	600 V 6 A
dc (dc-13) <ul style="list-style-type: none"> ■ Rated Operational Voltage ■ Rated Operational Current 	125/250 V 0.5/0.25 A	125/250 V 0.5/0.15 A	125/250 V 0.5/0.15 A	125/250 V 0.5/0.25 A	125/250 V 0.5/0.25 A
Backup Fuse Miniature Circuit Breaker	6/4/4 A 6/4 A	4 6/4/4 A 6/4 A	4 6/4/4 A 6/4 A	4 6/4/4 A 6/4 A	4 6/4/4 A 6/4 A
Releases					
Undervoltage Releases ("r" Releases) Response Voltage: <ul style="list-style-type: none"> ■ Drop (Breaker Tripped) U_S ■ Pickup (Breaker May Be Switched on) U_S 	35 – 70% 85 – 110%	35 – 70% 85 – 110%	35 – 70% 85 – 110%	35 – 70% 85 – 110%	35 – 70% 85 – 110%
Power Consumption in Continuous Operation at: <ul style="list-style-type: none"> ■ 50/60 Hz 12 Vac ■ 50/60 Hz 24 Vac ■ 50/60 Hz 48 – 60 Vac ■ 50/60 Hz 110 – 127 Vac ■ 50/60 Hz 208 – 240 Vac ■ 50/60 Hz 380 – 500 Vac ■ 50/60 Hz 525 – 600 Vac ■ 12 Vdc ■ 24 Vdc ■ 48 – 60 Vdc ■ 110 – 125 Vdc ■ 220 – 250 Vdc 	0.95 VA 0.72 VA 1.15 – 1.78 VA 0.96 – 1.25 VA 1.28 – 1.68 VA 2.2 – 3.9 VA 3.4 – 4.3 VA 0.88 W 0.70 W 1.12 – 1.76 W 0.94 – 1.21 W 1.45 – 1.86 W	1.9 VA 3.9 VA 2.5 – 3.8 VA 1.8 – 2.4 VA 2.7 – 3.8 VA 3.4 – 5.8 VA 3.4 – 4.3 VA 1.6 W 3.1 W 2.0 – 3.1 W 1.6 – 2.2 W 3.1 – 4 W	1.9 VA 3.9 VA 2.5 – 3.8 VA 1.8 – 2.4 VA 2.7 – 3.8 VA 3.4 – 5.8 VA 3.4 – 4.3 VA 1.6 W 3.1 W 2.0 – 3.1 W 1.6 – 2.2 W 3.1 – 4 W	1.9 VA 2.4 VA 2.3 – 4.1 VA 3.4 – 4.2 VA 4.8 – 6.5 VA 6.8 – 12.0 VA — 2.6 W 3.6 W 3.5 – 5.5 W 2.9 – 3.6 W 4.8 – 6.3 W	2.9 VA 3.1 VA 3.4 – 6.0 VA 3.3 – 3.8 VA 4.2 – 7.2 VA 3.8 – 10.0 VA — 3.4 W 4.3 W 4.8 – 7.2 W 3.3 – 3.8 W 6.6 – 7.5 W
Maximum Opening Time	50 ms	50 ms	50 ms	62 ms	62 ms
Shunt Trips					
Shunt Trips ("f" Releases) Response Voltage: <ul style="list-style-type: none"> ■ Pickup (Breaker Tripped) U_S 	70 – 110%	70 – 110%	70 – 110%	70 – 110%	70 – 110%
Power Consumption in (Short Time) at: <ul style="list-style-type: none"> ■ 50/60 Hz 24 Vac ■ 50/60 Hz 48 – 60 Vac ■ 50/60 Hz 48 – 127 Vac ■ 50/60 Hz 110 – 240 Vac ■ 50/60 Hz 380 – 440 Vac ■ 50/60 Hz 380 – 600 Vac ■ 50/60 Hz 480 – 600 Vac ■ 12 – 24 Vdc ■ 48 – 60 Vdc ■ 110 – 125 Vdc ■ 220 – 250 Vdc 	10 – 41 VA 139 – 210 VA — 83 – 360 VA — 418 – 1080 VA — 29 – 120 W 475 – 720 W 99 – 121 W —	87 – 405 VA 710 – 1105 VA — 66 – 432 VA 127 – 188 VA — 34 – 60 VA 164 – 631 W 830 – 1580 W 112 – 150 W 40 – 58 W	87 – 405 VA 710 – 1105 VA — 66 – 432 VA 127 – 188 VA — 34 – 60 VA 164 – 631 W 830 – 1580 W 112 – 150 W 40 – 58 W	98 – 475 VA 24 – 50 VA — 67 – 432 VA 76 – 110 VA — 19 – 42 VA 145 – 610 W 67 – 102 W 121 – 150 W 46 – 55 W	612 VA 403 – 666 VA — 396 – 1896 VA 1596 – 2156 VA — 230 – 384 VA 396 W 341 – 528 W 264 – 350 W 374 – 475 W
Maximum Load Duration	Interrupts Automatically				
Maximum Opening Time	50 ms	50 ms	50 ms	62 ms	62 ms
Moulded Case Switch (with High Magnetic Trip)					
Unfused kAIC at 480 Vac (415 Vac) Self-Protected, Will Trip Above: 	65 (70) 1250 for GE125; 1600 for GE160	65 (70) 2500	65 (70) 4000/6300	65 (70) 12,500	65 (70) 20,000

dc Switching Duty

The GE- to GL-Frame circuit breakers are also suitable for switching dc currents.

The GN- and GR-Frame circuit breakers are not suitable for dc currents due to the solid-state overcurrent release system.

For switching dc currents, however, the maximum permissible dc voltage per conducting path has to be considered.

For voltages higher than 250 volts, the series connection of two or three conducting paths is required.

As the current has to flow through all conducting paths so as to maintain the thermal tripping characteristics, the following circuit arrangements are recommended. With dc, the trip values of the instantaneous short circuit release (“n” release) are increased by 30 to 40%.

Table 4. For 3- and 4-Pole Circuit Breakers

Proposed Circuit	Maximum Permissible Vdc U _e	Remarks
<p>NSI-5178a</p>	250 Vdc	Double-pole switching. If there is no risk of an earth fault, or if any earth fault which occurs is immediately eliminated (earth fault monitoring), the maximum permissible dc voltage can be 600 volts.
<p>NSI-5179a</p>	440 Vdc	Double-pole switching (earth system). The earthed pole must always be assigned to the individual conducting path, so that two paths are always in series in the event of an earth fault.
<p>NSI-5180</p>	600 Vdc	Single-pole switching (earthed system). Three conducting paths in series. The earthed pole must be assigned to the nonswitched conducting path.
<p>NSI-5181</p>	750 Vdc	Single-pole switching (earthed system). Four conducting paths in series. The earthed pole must be assigned to the nonswitched conducting path.

Multi-Function Electronic Trip Units for All Applications

Digitrip RMS Trip Units

True rms Sensing

Digitrip RMS Trip Units utilize our patented microprocessor-based intelligence to provide true rms sensing, permitting increased accuracy and reliable system protection. True rms sensing is not susceptible to nuisance tripping when waveforms containing high harmonic currents are present.

Digitrip RMS 310

Digitrip RMS 310 Electronic Trip Units are available with Cutler-Hammer Circuit Breakers J-, L-, N- and R-Frames 20 through 2500 amperes. Digitrip RMS 310 Trip Units are available in four styles with either fixed or adjustable rating plugs which establishes the continuous ampere rating of the breaker.

Note: GJ- and GL-Frames have selectable long time delay (t_{LD}) and pickup settings (I_p). A rating plug is not required.

Rating Plugs

If rating plugs are needed, they are marked for 50/60 Hz applications. Both fixed and adjustable rating plugs are available, providing further flexibility when applied to selectively coordinated systems.

Note: Digitrip RMS rating plugs are not interchangeable with Seltronic™ rating plugs.

Curve Shaping

When selectively coordinated systems are called for, Digitrip RMS 310 will provide a cost-effective solution for a variety of applications.

The standard Digitrip RMS 310 includes an adjustable short time pickup setting encompassing an I^2t ramp function which provides the basic LS curve shaping function. GJ- and GL-Frames have an adjustable long time delay.

Note: GJ- and GL-Frames have selectable long time delay (t_{LD}) and pickup settings (I_p). A rating plug is not required.

The optional Digitrip RMS 310 provides additional flat response short time delay adjustments on an instantaneous setting to provide LSI curve shaping capability.

Digitrip RMS 310 Trip Units are available with ground fault pickup and flat response ground fault delay which provides the trip unit with full function LSG and LSG curve shaping flexibility.

Note: Contact factory for availability of ground fault for GL-Frame trip unit.

Digitrip RMS 310 Trip Units can effectively coordinate with both sophisticated upstream power breakers as well as downstream thermal magnetic breakers...making Digitrip RMS 310 Trip Units the cost-effective reliable choice for selectively coordinated systems.

Thermal Memory

All Digitrip RMS Trip Units incorporate a long delay. Thermal memory prevents the system from cumulative overheating due to repeated overcurrent events that may occur in quick succession.

Field Testing

A field test kit is available for Digitrip RMS 310 trip units.

Digitrip RMS 610 and 910



RMS 610



RMS 910

Digitrip RMS 610 and 910 Trip Units are available with Cutler-Hammer R-Frame Circuit Breakers 800 through 2500 amperes. Digitrip 610 and 910 Trip Units provide unparalleled system protection with the added convenience of a local display.

Curve Shaping

Digitrip RMS 610 and 910 Trip Units are available with up to nine curve shaping choices achieved by adjusting up to seven switches on the front of the unit for optimum system coordination. Maximum curve shaping flexibility is provided by dependent long and short delay adjustments that are long delay pickup (I_p) based, depicted on the front of the unit by the blue portion of the time-current curve.

Additional coordination capability can be provided by utilizing the short delay and ground fault zone selective interlocking features available on these trip units.

System Diagnostics

Digitrip RMS 610 and 910 models of trip units provide long delay, short delay, instantaneous, and ground fault cause of trip LEDs on the front of the unit. Their display shows a magnitude of trip information, as well as remote signal contacts, for improved system alarming.

System Monitoring

Digitrip 610 and 910 Trip Units have the capability to monitor phase currents, as well as neutral or ground currents. This information is displayed on a large digital display mounted on the unit.

Digitrip RMS 910 Trip Units can also provide the user with power and energy monitoring capability. Peak power demand, present power demand, and total energy, as well as forward and reverse energy can be monitored with this unit.

Digitrip RMS 910 Trip Units have the additional capability of monitoring line-to-line voltage, as well as system power factor. Both parameters are displayed in the digital display window and are supported by LEDs to indicate which parameter is being displayed.

Harmonics Monitoring

Digitrip RMS 910 Trip Units are capable of displaying values of current harmonics in the digital display window. Percentage of harmonic content can be monitored for each phase, up to the 27th harmonic. Additionally, a total harmonic distortion value can be calculated and displayed.

Communications



Digitrip RMS 910 units have built-in communications options to allow all protection, monitoring, and control information to be transmitted back to a central location via the Cutler-Hammer PowerNet™ system.

Field Testing

Integral field testing capability is provided on all 610 and 910 Trip Units. No additional test set is needed to perform both trip and no trip field testing.

Digitrip RMS Electronic Trip Unit Selection Guide

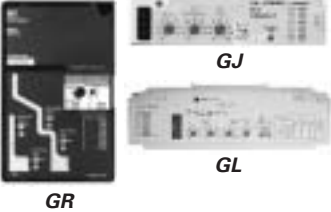
Table 5. Digitrip RMS Electronic Trip Unit Selection Guide

Digitrip	RMS 310	RMS 610	RMS 910
	 <p>GJ GL GR</p>		

Breaker Type

Cutler-Hammer Frame(s)	GJ-, GL-, GN- and GR-Frames	GR-Frame	GR-Frame
Ampere Rating	20 – 2500 A	800 – 2500 A	800 – 2500 A
Interrupting Rating at 415 V	35, 70, 100 kA	70, 100 kA	70, 100 kA

Trip Unit Sensing

rms Sensing	Yes	Yes	Yes
-------------	-----	-----	-----

Protection and Coordination

Protection	Ordering Options	LS, LSG	LSI, LSIG	LI, LS, LSI, LIG, LSG, LSIG	LI, LS, LSI, LIG, LSG, LSIG
	Fixed Rating Plug (I_N) ^①	Yes	Yes	Yes	Yes
	Overtemperature Trip	Yes	Yes	Yes	Yes
Long Delay	Adjustable Rating Plug (I_N) ^①	Yes	Yes	No	No
	Long Delay Setting	0.5 – 1.0 (I_N) ^②	0.5 – 1.0 (I_N) ^②	0.5 – 1.0 x (I_N)	0.5 – 1.0 x (I_N)
	Long Delay Time I^2t at 6x	10 Seconds ^②	10 Seconds ^②	2 – 24 Seconds	2 – 24 Seconds
	Long Delay Thermal Memory	Yes	Yes	Yes	Yes
	High Load Alarm	No	No	0.85 x I_r	0.85 x I_r
Short Delay	Short Delay Setting	200 – 800% x (I_N) ^③	200 – 800% x (I_N) ^③	200 – 600% S1 & S2 x (I_r)	200 – 600% S1 & S2 x (I_r)
	Short Delay Time I^2t	100 ms	No	100, 300, 500 ms	100, 300, 500 ms
	Short Delay Time Flat	No	1 – 300 ms	100 – 500 ms	100 – 500 ms
	Short Delay Time ZSI	No	No	Yes	Yes
Instantaneous	Instantaneous Setting	No	200 – 800% x (I_N) ^④	200 – 600% M1 & M2 x (I_N)	200 – 600% M1 & M2 x (I_N)
	Discriminator	No	No	Yes ^⑤	Yes ^⑤
	Instantaneous Override	Yes	Yes	Yes	Yes
Ground Fault	Ground Fault Setting	Var/Frame ^⑥	Var/Frame ^⑥	25 – 100% x (I_N) ^⑥	25 – 100% x (I_N) ^⑥
	Ground Fault Delay I^2t at .62x	No	No	100, 300, 500 ms	100, 300, 500 ms
	Ground Fault Delay Flat	1 – 500 ms ^⑦	1 – 500 ms ^⑦	100 – 500 ms	100 – 500 ms
	Ground Fault ZSI	No	No	Yes	Yes
	Ground Fault Thermal Memory	No	No	Yes	Yes

System Diagnostics

Cause of Trip LEDs	No	No	Yes	Yes
Magnitude of Trip Information	No	No	Yes	Yes
Remote Signal Contacts	No	No	Yes	Yes

System Monitoring

Digital Display	No	No	Yes	Yes
Current	No	No	Yes	Yes
Voltage	No	No	No	Yes
Power and Energy	No	No	No	Yes
Power Quality — Harmonics	No	No	No	Yes
Power Factor	No	No	No	Yes

System Communications

PowerNet	No	No	No	Yes
----------	----	----	----	-----

Field Testing

Testing Method	Test Set	Test Set	Integral	Integral
----------------	----------	----------	----------	----------

① GJ- and GL-Frames have selectable settings instead of a rating plug.

② GJ- and GL-Frames have adjustable long delay times of 2 – 24 seconds.

③ 2500 ampere GR-Frame 200 – 600% x (I_N).

④ GJ-Frame also has a 14X setting.

⑤ LS, LSG only.

⑥ Not to exceed 1200 amperes.

⑦ GJ- and GL-Frames are Instantaneous, 120 ms. GN- and GR-Frames are Instantaneous, 100, 300 and 500 ms.

Note: I_N = Rating plug rating.
 I_r = Long delay setting.

GE-Frame, 160 Amperes — Selection Guide and Ordering Information



GE Frame

Table 6. UL 489/IEC 60947-2 Interrupting Capacity Ratings

Circuit Breaker Type	Number of Poles	Interrupting Capacity (Symmetrical Amperes) (kA)													
		Volts ac (50/60 Hz)										Volts dc ①			
		120	220 – 240		277	347		380 – 415		480	600Y/347	125		250 ②③	
	I _{cu}	I _{cs}		I _{cu}	I _{cs}	I _{cu}	I _{cs}	I _{cu}	I _{cs}		I _{cu}	I _{cs}	I _{cu}	I _{cs}	
GEB	1 2, 3, 4	35 —	25 25	25 25	18 —	— —	— —	— —	— —	— —	— —	10 —	10 —	— 10	— 10
GEE	2, 3, 4	—	35	35	—	—	—	25	25	25	18	—	—	10	10
GES	1 2, 3, 4	100 —	85 85	43 43	35 —	22 —	— —	40 30	30 35	— 22	22	35	35	—	35
GEH	1 2, 3, 4	200 —	100 100	50 50	65 —	25 —	— —	— 70	— 35	— 65	25	42	42	—	42

- ① dc ratings apply to substantially non-inductive circuits.
 - ② 2-pole circuit breaker, or two poles of 3-pole circuit breaker.
 - ③ Time constant is 3 milliseconds minimum at 10 kA and 8 milliseconds minimum at 42 kA.
- Note:** Contact Eaton for availability of E125 frame breakers in panelboards and switchboards.

Table 7. Complete Circuit Breaker ④ — Includes Frame, Trip Unit, End Caps and Metric Mounting Hardware ⑤

Maximum Continuous Ampere Rating at 40°C ⑦	1-Pole	2-Pole	3-Pole ④	Adjustable Thermal Fixed Magnetic ⑦	Thermal Range	4-Pole ⑥	Adjustable Thermal Fixed Magnetic ⑦	Thermal Range
	Fixed Thermal Fixed Magnetic ⑦	Fixed Thermal Fixed Magnetic ⑦	Fixed Thermal Fixed Magnetic			Fixed Thermal Fixed Magnetic		
IC Rating: 25 kAIC at 240 Vac		IC Rating: 18 kAIC at 415 and 480 Vac						
15	GEB1015FFG	GEB2015FFG	GEB3015FFM	—	—	GEB7015FFM	—	—
16	GEB1016FFG	GEB2016FFG	GEB3016FFM	—	—	GEB7016FFM	—	—
20	GEB1020FFG	GEB2020FFG	GEB3020FFM	GEB3020AFM	16 – 20	GEB7020FFM	GEB7020AFM	16 – 20
25	GEB1025FFG	GEB2025FFG	GEB3025FFM	GEB3025AFM	20 – 25	GEB7025FFM	GEB7025AFM	20 – 25
30	GEB1030FFG	GEB2030FFG	GEB3030FFM	—	—	GEB7030FFM	—	—
32	GEB1032FFG	GEB2032FFG	GEB3032FFM	GEB3032AFM	25 – 32	GEB7032FFM	GEB7032AFM	25 – 32
35	GEB1035FFG	GEB2035FFG	GEB3035FFM	—	—	GEB7035FFM	—	—
40	GEB1040FFG	GEB2040FFG	GEB3040FFM	GEB3040AFM	32 – 40	GEB7040FFM	GEB7040AFM	32 – 40
45	GEB1045FFG	GEB2045FFG	GEB3045FFM	—	—	GEB7045FFM	—	—
50	GEB1050FFG	GEB2050FFG	GEB3050FFM	GEB3050AFM	40 – 50	GEB7050FFM	GEB7050AFM	40 – 50
60	GEB1060FFG	GEB2060FFG	GEB3060FFM	—	—	GEB7060FFM	—	—
63	GEB1063FFG	GEB2063FFG	GEB3063FFM	GEB3063AFM	50 – 63	GEB7063FFM	GEB7063AFM	50 – 63
70	GEB1070FFG	GEB2070FFG	GEB3070FFM	—	—	GEB7070FFM	—	—
80	GEB1080FFG	GEB2080FFG	GEB3080FFM	GEB3080AFM	63 – 80	GEB7080FFM	GEB7080AFM	63 – 80
90	GEB1090FFG	GEB2090FFG	GEB3090FFM	—	—	GEB7090FFM	—	—
100	GEB1100FFG	GEB2100FFG	GEB3100FFM	GEB3100AFM	80 – 100	GEB7100FFM	GEB7100AFM	80 – 100
125	GEB1125FFG	GEB2125FFG	GEB3125FFM	GEB3125AFM	100 – 125	GEB7125FFM	GEB7125AFM	100 – 125
160	—	—	GEB3160FFM	GEB3160AFM	125 – 160	GEB7160FFM	GEB7160AFM	125 – 160
IC Rating: 35 kAIC at 240 Vac		IC Rating: 25 kAIC at 415 and 480 Vac						
15	—	GEE2015FFG	GEE3015FFM	—	—	GEE7015FFM	—	—
16	—	GEE2016FFG	GEE3016FFM	—	—	GEE7016FFM	—	—
20	—	GEE2020FFG	GEE3020FFM	GEE3020AFM	16 – 20	GEE7020FFM	GEE7020AFM	16 – 20
25	—	GEE2025FFG	GEE3025FFM	GEE3025AFM	20 – 25	GEE7025FFM	GEE7025AFM	20 – 25
30	—	GEE2030FFG	GEE3030FFM	—	—	GEE7030FFM	—	—
32	—	GEE2032FFG	GEE3032FFM	GEE3032AFM	25 – 32	GEE7032FFM	GEE7032AFM	25 – 32
35	—	GEE2035FFG	GEE3035FFM	—	—	GEE7035FFM	—	—
40	—	GEE2040FFG	GEE3040FFM	GEE3040AFM	32 – 40	GEE7040FFM	GEE7040AFM	32 – 40
45	—	GEE2045FFG	GEE3045FFM	—	—	GEE7045FFM	—	—
50	—	GEE2050FFG	GEE3050FFM	GEE3050AFM	40 – 50	GEE7050FFM	GEE7050AFM	40 – 50
60	—	GEE2060FFG	GEE3060FFM	—	—	GEE7060FFM	—	—
63	—	GEE2063FFG	GEE3063FFM	GEE3063AFM	50 – 63	GEE7063FFM	GEE7063AFM	50 – 63
70	—	GEE2070FFG	GEE3070FFM	—	—	GEE7070FFM	—	—
80	—	GEE2080FFG	GEE3080FFM	GEE3080AFM	63 – 80	GEE7080FFM	GEE7080AFM	63 – 80
90	—	GEE2090FFG	GEE3090FFM	—	—	GEE7090FFM	—	—
100	—	GEE2100FFG	GEE3100FFM	GEE3100AFM	80 – 100	GEE7100FFM	GEE7100AFM	80 – 100
125	—	GEE2125FFG	GEE3125FFM	GEE3125AFM	100 – 125	GEE7125FFM	GEE7125AFM	100 – 125
160	—	—	GEE3160FFM	GEE3160AFM	125 – 160	GEE7160FFM	GEE7160AFM	125 – 160

- ④ Replace suffix “M” or “G” with “W” for no line and load terminals. Replace suffix M with G for standard cable terminals included.
- ⑤ 1- and 2-pole breakers include standard terminals.
- ⑥ Neutral protection is indicated by the fourth character: 4=0%, 7=100%.
- ⑦ 16, 32, 63, 160 amperes are not NEMA rated. Maximum NEMA rating for GE is 125 amperes. Adjustable thermal trip units are typically used in IEC markets and are not NEMA rated.

Frame Size GE, 160 Amperes (125 Amperes NEMA)

Table 7. Complete Circuit Breaker ^① — Includes Frame, Trip Unit, End Caps and Metric Mounting Hardware (Continued) ^②

Maximum Continuous Ampere Rating at 40°C ^④	1-Pole		2-Pole		3-Pole ^①		4-Pole ^③		
	Fixed Thermal Fixed Magnetic ^④	Fixed Thermal Fixed Magnetic ^④	Fixed Thermal Fixed Magnetic ^④	Fixed Thermal Fixed Magnetic ^④	Adjustable Thermal Fixed Magnetic ^④	Thermal Range	Fixed Thermal Fixed Magnetic ^④	Adjustable Thermal Fixed Magnetic ^④	Thermal Range
IC Rating: 85 kAIC at 240 Vac			IC Rating: 40 kAIC at 415 Vac, 35 kAIC at 480 Vac						
15	GES1015FFG	GES2015FFG	GES3015FFM	—	—	—	GES7015FFM	—	—
16	GES1016FFG	GES2016FFG	GES3016FFM	—	—	—	GES7016FFM	—	—
20	GES1020FFG	GES2020FFG	GES3020FFM	GES3020AFM	16 – 20	—	GES7020FFM	GES7020AFM	16 – 20
25	GES1025FFG	GES2025FFG	GES3025FFM	GES3025AFM	20 – 25	—	GES7025FFM	GES7025AFM	20 – 25
30	GES1030FFG	GES2030FFG	GES3030FFM	—	—	—	GES7030FFM	—	—
32	GES1032FFG	GES2032FFG	GES3032FFM	GES3032AFM	25 – 32	—	GES7032FFM	GES7032AFM	25 – 32
35	GES1035FFG	GES2035FFG	GES3035FFM	—	—	—	GES7035FFM	—	—
40	GES1040FFG	GES2040FFG	GES3040FFM	GES3040AFM	32 – 40	—	GES7040FFM	GES7040AFM	32 – 40
45	GES1045FFG	GES2045FFG	GES3045FFM	—	—	—	GES7045FFM	—	—
50	GES1050FFG	GES2050FFG	GES3050FFM	GES3050AFM	40 – 50	—	GES7050FFM	GES7050AFM	40 – 50
60	GES1060FFG	GES2060FFG	GES3060FFM	—	—	—	GES7060FFM	—	—
63	GES1063FFG	GES2063FFG	GES3063FFM	GES3063AFM	50 – 63	—	GES7063FFM	GES7063AFM	50 – 63
70	GES1070FFG	GES2070FFG	GES3070FFM	—	—	—	GES7070FFM	—	—
80	GES1080FFG	GES2080FFG	GES3080FFM	GES3080AFM	63 – 80	—	GES7080FFM	GES7080AFM	63 – 80
90	GES1090FFG	GES2090FFG	GES3090FFM	—	—	—	GES7090FFM	—	—
100	GES1100FFG	GES2100FFG	GES3100FFM	GES3100AFM	80 – 100	—	GES7100FFM	GES7100AFM	80 – 100
125	GES1125FFG	GES2125FFG	GES3125FFM	GES3125AFM	100 – 125	—	GES7125FFM	GES7125AFM	100 – 125
IC Rating: 100 kAIC at 240 Vac			IC Rating: 70 kAIC at 415 Vac, 65 kAIC at 480 Vac						
15	GEH1015FFG	GEH2015FFG	GEH3015FFM	—	—	—	GEH7015FFM	—	—
16	GEH1016FFG	GEH2016FFG	GEH3016FFM	—	—	—	GEH7016FFM	—	—
20	GEH1020FFG	GEH2020FFG	GEH3020FFM	GEH3020AFM	16 – 20	—	GEH7020FFM	GEH7020AFM	16 – 20
25	GEH1025FFG	GEH2025FFG	GEH3025FFM	GEH3025AFM	20 – 25	—	GEH7025FFM	GEH7025AFM	20 – 25
30	GEH1030FFG	GEH2030FFG	GEH3030FFM	—	—	—	GEH7030FFM	—	—
32	GEH1032FFG	GEH2032FFG	GEH3032FFM	GEH3032AFM	25 – 32	—	GEH7032FFM	GEH7032AFM	25 – 32
35	GEH1035FFG	GEH2035FFG	GEH3035FFM	—	—	—	GEH7035FFM	—	—
40	GEH1040FFG	GEH2040FFG	GEH3040FFM	GEH3040AFM	32 – 40	—	GEH7040FFM	GEH7040AFM	32 – 40
45	GEH1045FFG	GEH2045FFG	GEH3045FFM	—	—	—	GEH7045FFM	—	—
50	GEH1050FFG	GEH2050FFG	GEH3050FFM	GEH3050AFM	40 – 50	—	GEH7050FFM	GEH7050AFM	40 – 50
60	GEH1060FFG	GEH2060FFG	GEH3060FFM	—	—	—	GEH7060FFM	—	—
63	GEH1063FFG	GEH2063FFG	GEH3063FFM	GEH3063AFM	50 – 63	—	GEH7063FFM	GEH7063AFM	50 – 63
70	GEH1070FFG	GEH2070FFG	GEH3070FFM	—	—	—	GEH7070FFM	—	—
80	GEH1080FFG	GEH2080FFG	GEH3080FFM	GEH3080AFM	63 – 80	—	GEH7080FFM	GEH7080AFM	63 – 80
90	GEH1090FFG	GEH2090FFG	GEH3090FFM	—	—	—	GEH7090FFM	—	—
100	GEH1100FFG	GEH2100FFG	GEH3100FFM	GEH3100AFM	80 – 100	—	GEH7100FFM	GEH7100AFM	80 – 100
125	GEH1125FFG	GEH2125FFG	GEH3125FFM	GEH3125AFM	100 – 125	—	GEH7125FFM	GEH7125AFM	100 – 125

^① Replace suffix "M" or "G" with "W" for no line and load terminals. Replace suffix M with G for standard cable terminals included.

^② 1- and 2-pole breakers include standard terminals.

^③ Neutral protection is indicated by the fourth character: 4 = 0%, 7 = 100%.

^④ 16, 32, 63, 160 amperes are not NEMA rated. Maximum NEMA rating for GE is 125 amperes. Adjustable thermal trip units are typically used in IEC markets and are not NEMA rated.

Table 8. Moulded Case Switches

Ampere Rating	Number of Poles	Catalogue Number
125	3	GEK3125KSM
160	3	GEK3160KSM ^⑤

^⑤ 16, 32, 63, 160 amperes are not NEMA rated. Maximum NEMA rating for GE is 125 amperes. Adjustable thermal trip units are typically used in IEC markets and are not NEMA rated.

Line and Load Terminals

GE-Frame circuit breakers and Moulded case switches have 3T125EF line and load terminals as standard equipment.

Table 9. Line and Load Terminals

Maximum Breaker Amperes	Terminal Body Material	Wire Type	Metric Wire Range mm ²	AWG Wire Range	Catalogue Number Package of 3 Terminals
125	Steel	Cu/Al	2.5-95	#14-3/0	3T125EF ①
125	Aluminum	Cu/Al	2.5-50	#14-1/0	3TA125EF
125	Aluminum	Cu/Al	16-95	#6-3/0	3TA150EF
160	Aluminum	Cu/Al	35-120	#3-250	3TA160EFK ②
160	Aluminum	Cu/Al	35-120	#3-250	4TA160EFK ③

① Standard line and load terminals included with GE-Frame MCCBs.

② 3 terminals with terminal shield.

③ 4 terminals with terminal shield.

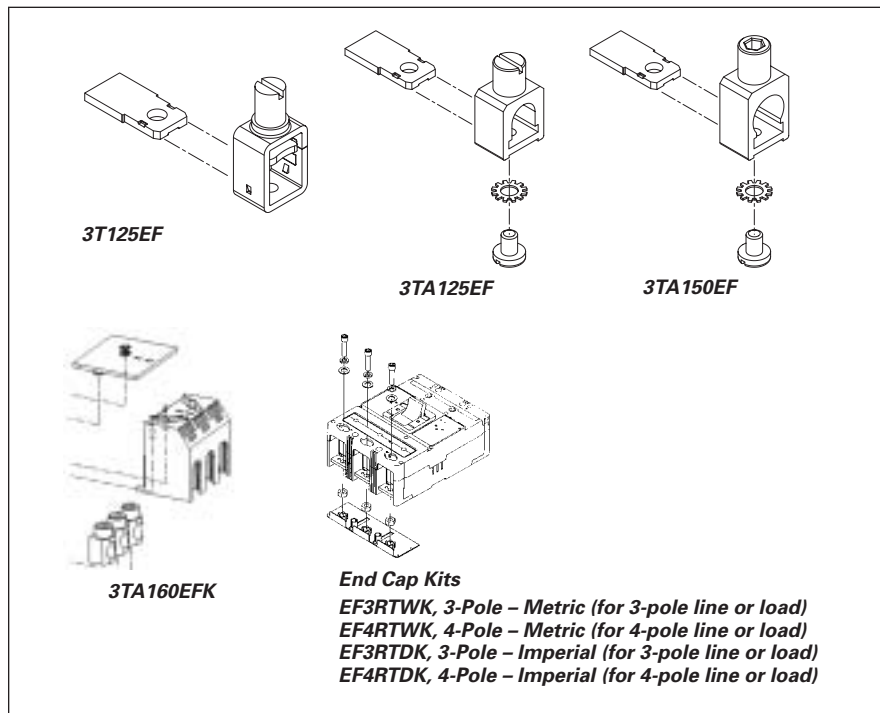

Figure 3. Line and Load Terminals, and End Cap Kits

Insert collar enclosing conductor as shown in **Figure 3**. Locate nut on top of conductor and tighten securely with screw and washer.

Caution: Collar must surround conductor.

Insert collar enclosing conductor and center on extrusion. Tighten securely with screw and washer.

End cap kits are used on the E-Frame breaker line side to connect bus bar or similar electrical connections. Includes hardware.

Control Wire Terminal Kit

For use with steel or stainless steel terminals only.

Note: Standard line and load terminals included with GE-Frame MCCBs.

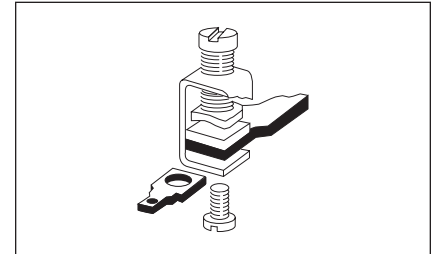

Figure 4. Control Wire Terminal Kit

Table 10. Control Wire Terminal Kit

Description	Catalogue Number
Package of 12 (Priced Individually)	GCWTK

Interphase Barriers

The interphase barrier is available for extended insulation between circuit breaker poles. Specify quantity when ordering.

Table 11. Interphase Barriers

Description	Catalogue Number
Package of 2	EIPBK

Base Mounting Hardware

Metric base mounting hardware is included with a circuit breaker or Moulded case switch. A DIN rail adapter is available.

Note: English mounting hardware kit can be supplied: Catalogue Number **BMHE**.

Table 12. Base Mounting Hardware

DIN Rail Adapter	Catalogue Number
3- or 4-Pole	EF34DIN

Frame Size GE, 160 Amperes (125 Amperes NEMA)

Multiwire Connectors

Field-installed multiwire connectors for the load side (OFF) end terminals. They are used to distribute the load from the circuit breaker to multiple devices without the use of separate distribution terminal blocks.

Multiwire lug kits include mounting hardware, insulators and tin-plated aluminum connectors to replace three mechanical load lugs. UL listed for copper only as used on the load side (OFF) end.

Table 13. GE-Frame Multiwire Connectors Ordering Information (Package of 3)

Maximum Amperes	Wires per Terminal	Wire Size Range AWG Cu	Kit Catalogue Number
125	3	14 – 2	3TA100E3K
125	6	14 – 6	3TA100E6K

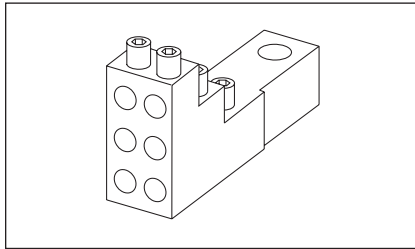

Figure 5. Multiwire Connectors

Terminal Shields

The terminal shield is available for line terminal areas in 2-, 3- and 4-pole circuit breakers. The standard style number by pole for each terminal shield is for a package of 2 and is priced per each package.

Table 14. Terminal Shields

Number of Poles	Standard Package of 2	IP30 Protection
1P (Load end)	EFTS1KA	
1P (Line end)	EFTS1KB	
2	EFTS2K	
3	EFTS3K	
4	EFTS4K	

Terminal End Covers (Gas Barrier)

The terminal end cover is available for 3-pole circuit breakers only. Two conductor opening sizes are available. Specify quantity (one per circuit breaker) when ordering.

Table 15. Terminal End Covers (Gas Barrier)

Conductor Opening Diameter — mm (Inches)	Catalogue Number
6.4 (0.25)	EEC3K
10.4 (0.41)	EEC4K

Terminal Extensions

Table 16. Terminal Extensions

Number of Poles	Catalogue Number
3	EFTES3
4	EFTES4

Terminal Spreaders

Table 17. Terminal Spreaders

Number of Poles	Catalogue Number
3	EFTEW3
4	EFTEW4

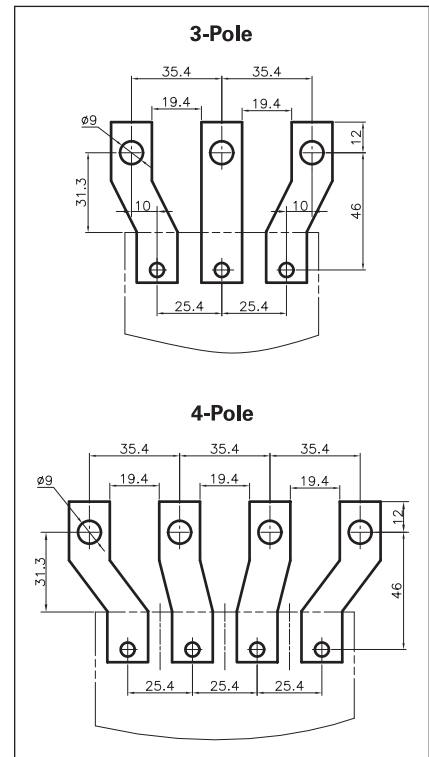

Figure 6. Terminal Spreaders

GJ-Frame, 250 Amperes — Selection Guide and Ordering Information



GJ Frame

Table 18. UL 489/IEC 60947-2 Interrupting Capacity Ratings

Circuit Breaker Type	Number of Poles	Interrupting Capacity (kA Symmetrical Amperes)									
		Volts ac (50/60 Hz)								Volts dc ①	
		220 – 240		380 – 415		480	600	690		250 ②③	
		I _{cu}	I _{cs}	I _{cu}	I _{cs}			I _{cu}	I _{cs}	I _{cu}	I _{cs}
GJE	2, 3, 4	65	65	25	25	25	18	12	6	10	10
GJS	2, 3, 4	85	85	40	40	35	18	12	6	22	22
GJH	2, 3, 4	100	100	70	70	65	25	14	7	22	22
GJC	2, 3, 4	200	150	100	75	100	50	20	10	42	42

① dc ratings apply to substantially non-inductive circuits.
 ② 2-pole circuit breaker, or two poles of 3-pole circuit breaker.
 ③ Time constant is 3 milliseconds minimum at 10 kA and 8 milliseconds minimum at 22 kA.
Note: Contact Eaton for availability of J250 frame breakers in panelboards and switchboards.

Table 19. Complete Circuit Breaker with Thermal-Magnetic Trip Unit — Includes Frame, Thermal-Magnetic Trip Units, End Caps and Metric Mounting Hardware ④⑤

Maximum Continuous Ampere Rating at 40°C	Magnetic Range	2-Pole		3-Pole		4-Pole ⑥		
		Fixed Thermal Adjustable Magnetic	Fixed Thermal Adjustable Magnetic	Adjustable Thermal Adjustable Magnetic ⑦	Thermal Range	Fixed Thermal Adjustable Magnetic	Adjustable Thermal Adjustable Magnetic ⑦	Thermal Range

IC Rating: 25 kAIC at 415 and 480 Vac

70	350 – 700	GJE2070FAG	GJE3070FAM	—	—	GJE4070FAM	—	—
80	400 – 800	—	—	GJE3080AAM	64 – 80	—	GJE4080AAM	—
90	450 – 900	GJE2080FAG	GJE3080FAM	—	—	GJE4080FAM	—	—
100	500 – 1000	GJE2100FAG	GJE3100FAM	GJE3100AAM	80 – 100	GJE4100FAM	GJE4100AAM	80 – 100
125	625 – 1250	GJE2125FAG	GJE3125FAM	GJE3125AAM	100 – 125	GJE4125FAM	GJE4125AAM	100 – 125
150	750 – 1500	GJE2150FAG	GJE3150FAM	—	—	GJE4150FAM	—	—
160	800 – 1600	—	—	GJE3160AAM	128 – 160	—	GJE4160AAM	128 – 160
175	875 – 1750	GJE2175FAG	GJE3175FAM	—	—	GJE4175FAM	—	—
200	1000 – 2000	GJE2200FAG	GJE3200FAM	GJE3200AAM	160 – 200	GJE4200FAM	GJE4200AAM	160 – 200
225	1125 – 2250	GJE2225FAG	GJE3225FAM	—	—	GJE4225FAM	—	—
250	1250 – 2500	GJE2250FAG	GJE3250FAM	GJE3250AAM	200 – 250	GJE4250FAM	GJE4250AAM	200 – 250

IC Rating: 40 kAIC at 415 Vac, 35 kAIC at 480 Vac

70	350 – 700	GJS2070FAG	GJS3070FAM	—	—	GJS4070FAM	—	—
80	400 – 800	—	—	GJS3080AAM	64 – 80	—	GJS4080AAM	—
90	450 – 900	GJS2090FAG	GJS3090FAM	—	64 – 80	GJS4090FAM	—	—
100	500 – 1000	GJS2100FAG	GJS3100FAM	GJS3100AAM	80 – 100	GJS4100FAM	GJS4100AAM	80 – 100
125	625 – 1250	GJS2125FAG	GJS3125FAM	GJS3125AAM	100 – 125	GJS4125FAM	GJS4125AAM	100 – 125
150	750 – 1500	GJS2150FAG	GJS3150FAM	—	—	GJS4150FAM	—	—
160	800 – 1600	—	—	GJS3160AAM	128 – 160	—	GJS4160AAM	128 – 160
175	875 – 750	GJS2175FAG	GJS3175FAM	—	—	GJS4175FAM	—	—
200	1000 – 2000	GJS2200FAG	GJS3200FAM	GJS3200AAM	160 – 200	GJS4200FAM	GJS4200AAM	160 – 200
225	1125 – 2250	GJS2225FAG	GJS3225FAM	—	—	GJS4225FAM	—	—
250	1250 – 2500	GJS2250FAG	GJS3250FAM	GJS3250AAM	200 – 250	GJS4250FAM	GJS4250AAM	200 – 250

IC Rating: 70 kAIC at 415 Vac, 65 kAIC at 480 Vac

70	350 – 700	GJH2070FAG	GJH3070FAM	—	—	GJH4070FAM	—	—
80	400 – 800	—	—	GJH3080AAM	64 – 80	—	GJH4080AAM	—
90	450 – 900	GJH2090FAG	GJH3090FAM	—	64 – 80	GJH4090FAM	—	—
100	500 – 1000	GJH2100FAG	GJH3100FAM	GJH3100AAM	80 – 100	GJH4100FAM	GJH4100AAM	80 – 100
125	625 – 1250	GJH2125FAG	GJH3125FAM	GJH3125AAM	100 – 125	GJH4125FAM	GJH4125AAM	100 – 125
150	750 – 1500	GJH2150FAG	GJH3150FAM	—	—	GJH4150FAM	—	—
160	800 – 1600	—	—	GJH3160AAM	128 – 160	GJH4160FAM ⑧	GJH4160AAM	128 – 160
175	875 – 1750	GJH2175FAG	GJH3175FAM	—	—	GJH4175FAM	—	—
200	1000 – 2000	GJH2200FAG	GJH3200FAM	GJH3200AAM	160 – 200	GJH4200FAM	GJH4200AAM	160 – 200
225	1125 – 2250	GJH2225FAG	GJH3225FAM	—	—	GJH4225FAM	—	—
250	1250 – 2500	GJH2250FAG	GJH3250FAM	GJH3250AAM	200 – 250	GJH4250FAM	GJH4250AAM	200 – 250

④ Replace suffix “M” or “G” with “W” for no line and load terminals. Replace suffix M with G for standard cable terminals included.
 ⑤ 2-pole includes standard terminals.
 ⑥ Adjustable thermal trip units are typically used in IEC markets and are not NEMA rated.
 ⑦ Neutral protection is indicated by the fourth character: 4 = 0%, 8 = adjustable 0 or 60% and 9 = 0 or 100%. 4-pole ground fault option does not have neutral protection.

Frame Size GJ, 250 Amperes

Table 19. Complete Circuit Breaker with Thermal-Magnetic Trip Unit — Includes Frame, Thermal-Magnetic Trip Units, End Caps and Metric Mounting (Continued) ①②

Maximum Continuous Ampere Rating at 40°C	Magnetic Range	2-Pole		3-Pole		4-Pole ④		
		Fixed Thermal Adjustable Magnetic	Fixed Thermal Adjustable Magnetic	Adjustable Thermal Adjustable Magnetic ③	Thermal Range	Fixed Thermal Adjustable Magnetic	Adjustable Thermal Adjustable Magnetic ③	Thermal Range
IC Rating: Component Frame Only — 25 kAIC at 415 and 480 Vac								
250	—	GJE2250NN	GJE3250NN	—	—	GJE4250NN	—	—
IC Rating: Component Frame Only — 40 kAIC at 415 Vac, 35 kAIC at 480 Vac								
250	—	GJS2250NN	GJS3250NN	—	—	GJS4250NN	—	—
IC Rating: Component Frame Only — 70 kAIC at 415 Vac, 65 kAIC at 480 Vac								
250	—	GJH2250NN	GJH3250NN	—	—	GJH4250NN	—	—
Thermal-Magnetic Trip Unit								
70	350 – 700	JT2070FA	JT3070FA	—	—	JT4070FA	—	—
80	400 – 800	—	—	JT3080AA ③	64 – 100	—	JT4080AA ③	—
90	450 – 900	JT2090FA	JT3090FA	—	—	JT4090FA	—	—
100	500 – 1000	JT2100FA	JT3100FA	JT3100AA ③	80 – 100	JT4100FA	JT4100AA ③	80 – 100
125	625 – 1250	JT2125FA	JT3125FA	JT3125AA ③	100 – 125	JT4125FA	JT4125AA ③	100 – 125
150	750 – 1500	JT2150FA	JT3150FA	—	—	JT4150FA	—	—
160	800 – 1600	JT2160FA ③	—	JT3160AA ③	128 – 160	—	JT4160AA ③	128 – 160
175	875 – 1750	JT2175FA	JT3175FA	—	—	JT4175FA	—	—
200	1000 – 2000	JT2200FA	JT3200FA	JT3200AA ③	160 – 200	JT4200FA	JT4200AA ③	160 – 200
225	1125 – 2250	JT2225FA	JT3225FA	—	—	JT4225FA	—	—
250	1250 – 2500	J2T250FA	JT3250FA	JT3250AA ③	200 – 250	JT4250FA	JT4250AA ③	200 – 250

① Replace suffix "M" or "G" with "W" for no line and load terminals. Replace suffix M with G for standard cable terminals included.

② 2-pole includes standard terminals.

③ Adjustable thermal trip units are typically used in IEC markets and are not NEMA rated.

④ Neutral protection is indicated by the fourth character: 4 = 0%, 8 = adjustable 0 or 60% and 9 = 0 or 100%.

Table 20. Complete GJ Breakers with Electronic Trip Unit ⑤⑥

Ampere Rating	LS	LSI	LSG ⑦	LSIG ⑦	Neutral CT ⑦⑧ for LSG & LSIG
3-Pole ⑨ — IC Rating: 25 kAIC at 415 and 480 Vac					
50	GJE305033M	GJE305032M	GJE305035M	GJE305036M	JGFCT050
100	GJE310033M	GJE310032M	GJE310035M	GJE310036M	JGFCT100
160	GJE316033M	GJE316032M	GJE316035M	GJE316036M	JGFCT160
250	GJE325033M	GJE325032M	GJE325035M	GJE325036M	JGFCT250
4-Pole ⑩ — IC Rating: 25 kAIC at 415 and 480 Vac					
50	GJE405033M	GJE405032M	GJE405035M	GJE405036M	JGFCT050
100	GJE410033M	GJE410032M	GJE410035M	GJE410036M	JGFCT100
160	GJE416033M	GJE416032M	GJE416035M	GJE416036M	JGFCT160
250	GJE425033M	GJE425032M	GJE425035M	GJE425036M	JGFCT250
3-Pole — IC Rating: 40 kAIC at 415 Vac, 35 kAIC at 480 Vac					
50	GJS305033M	GJS305032M	GJS305035M	GJS305036M	JGFCT050
100	GJS310033M	GJS310032M	GJS310035M	GJS310036M	JGFCT100
160	GJS316033M	GJS316032M	GJS316035M	GJS316036M	JGFCT160
250	GJS325033M	GJS325032M	GJS325035M	GJS325036M	JGFCT250
4-Pole ⑩ — IC Rating: 40 kAIC at 415 Vac, 35 kAIC at 480 Vac					
50	GJS405033M	GJS405032M	GJS405035M	GJS405036M	JGFCT050
100	GJS410033M	GJS410032M	GJS410035M	GJS410036M	JGFCT100
160	GJS416033M	GJS416032M	GJS416035M	GJS416036M	JGFCT160
250	GJS425033M	GJS425032M	GJS425035M	GJS425036M	JGFCT250
3-Pole — IC Rating: 70 kAIC at 415 Vac, 65 kAIC at 480 Vac					
50	GJH305033M	GJH305032M	GJH305035M	GJH305036M	JGFCT050
100	GJH310033M	GJH310032M	GJH310035M	GJH310036M	JGFCT100
160	GJH316033M	GJH316032M	GJH316035M	GJH316036M	JGFCT160
250	GJH325033M	GJH325032M	GJH325035M	GJH325036M	JGFCT250
4-Pole ⑩ — IC Rating: 70 kAIC at 415 Vac, 65 kAIC at 480 Vac					
50	GJH405033M	GJH405032M	GJH405035M	GJH405036M	JGFCT050
100	GJH410033M	GJH410032M	GJH410035M	GJH410036M	JGFCT100
160	GJH416033M	GJH416032M	GJH416035M	GJH416036M	JGFCT160
250	GJH425033M	GJH425032M	GJH425035M	GJH425036M	JGFCT250

⑤ Replace suffix "M" or "G" with "W" for no line and load terminals. Replace suffix M with G for standard cable terminals included.

⑥ For ac use only.

⑦ Neutral CT for LSG and LSIG applied to 4-wire applications must be ordered as a separate item.

⑧ Required for 4-wire systems if neutral protection is desired.

⑨ For 2-pole applications, use two outer poles.

⑩ Neutral protection 4 = 0%, 6 = 60%, 7 = 100% electronic trip unit neutral protection is not adjustable. 4-pole ground fault option does not have neutral protection.

Table 21. GJ Electronic Trip Units

Ampere Rating	LS	LSI	LSG	LSIG	Neutral CT ^① for LSG & LSIG
3-Pole					
50	JT305033	JT305032	JT305035	JT305036	JGFCT050
100	JT310033	JT310032	JT310035	JT310036	JGFCT100
160	JT316033	JT316032	JT316035	JT316036	JGFCT160
250	JT325033	JT325032	JT325035	JT325036	JGFCT250
4-Pole ^②					
50	JT405033	JT405032	JT405035	JT405036	JGFCT050
100	JT410033	JT410032	JT410035	JT410036	JGFCT100
160	JT416033	JT416032	JT416035	JT416036	JGFCT160
250	JT425033	JT425032	JT425035	JT425036	JGFCT250

^① Required for 4-wire systems if neutral protection is desired.

^② Neutral protection 4 = 0%, 6 = 60%, 7 = 100% electronic trip unit neutral protection is not adjustable.

Note: Long time pickup — no rating plug.

250 Ampere Settings — 250, 225, 200, 175, 160, 150, 125, 100.

160 Ampere Settings — 160, 150, 125, 110, 100, 90, 80, 63.

100 Ampere Settings — 100, 90, 80, 70, 63, 50, 45, 40.

50 Ampere Settings — 50, 45, 40, 32, 30, 25, 20.

Note: Adjustable long time delay — 2 – 24 seconds at 6 x I_r.

Adjustable short time delay — Inst., 120, 300 ms.

Note: Plug-in test kit — Catalogue Numbers **MTST120V** (120 Vac) or **MTST230V** (230 Vac).

**Table 22. Moulded Case Switches ^③
(Includes Line and Load Collars)**

Ampere Rating	Number of Poles	Catalogue Number
250	3	GJK3250KSM
	4	GJK7250KSM ^④

^③ For 2-pole applications, use outer poles of a 3-pole MCS.

^④ 100% neutral protection.



Digitrip 310+ Test Kit



Digitrip 310+ Test Kit Shown with GJ MCCB



GJ Digitrip 310+ Electronic Trip Unit

Frame Size GJ, 250 Amperes

Line and Load Terminals

GJ-Frame circuit breakers include Cu/Al terminals T250FJ as standard. When optional copper only terminals are required, order by catalogue number.

Table 23. Line and Load Terminals

Maximum Breaker Amperes	Terminal Body Material	Wire Type	Metric Wire Range mm ²	AWG Wire Range/Number of Conductors	Catalogue Number
-------------------------	------------------------	-----------	-----------------------------------	-------------------------------------	------------------

Standard Pressure Type Terminals

250	Stainless Steel	Cu	25 – 185	#4 – 350 (1)	T250FJ ①②
250	Aluminum	Cu/Al	25 – 185	#4 – 350 (1)	TA250FJ ①

Optional Copper and Cu/Al Pressure Type Terminals

250	Copper	Cu/Al	25 – 185	#4 – 350 (1)	TC250FJ ①③
-----	--------	-------	----------	--------------	------------

- ① Single terminals individually packed.
- ② Standard line and load terminals.
- ③ Contact factory for availability.

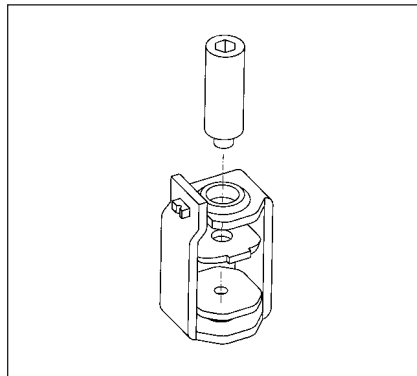

Figure 7. Standard Pressure Type Terminal T250FJ

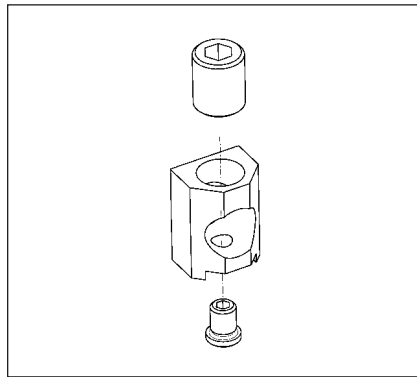

Figure 8. Standard and Optional Pressure Type Terminal TA250FJ/TC250FJ

End Cap Kit

End cap kits are used on J250-Frame breaker line side to connect bus bar or similar electrical connections. Includes hardware.

Table 24. Kit Catalogue Number — for Line or Load

Number of Poles	Catalogue Number	
	Metric	Imperial
3	FJ3RTWK	FJ3RTDK
4	FJ4RTWK	FJ4RTDK

Control Wire Terminal Kit

For use with aluminum or copper terminals only.

Table 25. Control Wire Terminal Kit

Description	Catalogue Number
Package of 14 (Priced Individually)	FJCVTK

Terminal Extensions

Table 26. Terminal Extensions

Number of Poles	Catalogue Number
3	FJTES3
4	FJTES4

Terminal Spreaders

Table 27. Terminal Spreaders

Number of Poles	Catalogue Number
3	FJTEW3
4	FJTEW4

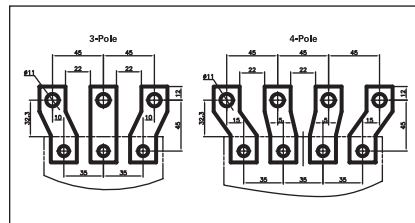

Figure 9. Terminal Spreaders

Multiwire Connectors

Field-installed multiwire connectors for the load side (OFF) end terminals. They are used to distribute the load from the circuit breaker to multiple devices without the use of separate distribution terminal blocks.

Multiwire lug kits include mounting hardware, insulators and tin-plated aluminum connectors to replace three mechanical load lugs. UL listed for copper only as used on the load side (OFF) end.

Table 28. GJ-Frame Multiwire Connectors Ordering Information (Package of 3)

Maximum Amperes	Wires per Terminal	Wire Size Range AWG Cu	Kit Catalogue Number
250	3	14 – 2	3TA250J3
250	6	14 – 6	3TA250J6

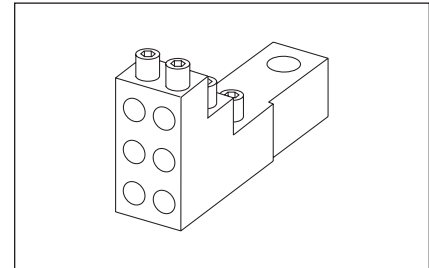

Figure 10. GJ-Frame Multiwire Connectors

Base Mounting Hardware

Base mounting hardware is included with a circuit breaker or Moulded case switch.

Table 29. Terminal Shields IP30

Location	Number of Poles	Catalogue Number Package of 1
Line or Load	2, 3, 4	FJTS3K FJTS4K

Table 30. Interphase Barriers

Package of 2	
Number of Poles	Catalogue Number
3	FJIPBK
4	FJIPBK4

GL-Frame, 630 Amperes



GL Frame

Table 31. UL 489/IEC 60947-2 Interrupting Capacity Ratings

Circuit Breaker Type	Number of Poles	Interrupting Capacity (kA Symmetrical Amperes)									
		Volts ac (50/60 Hz)								Volts dc	
		220 – 240 Vac		380 – 415 Vac		480 Vac	600 Vac	690 Vac		250 V	
		I_{cu}	I_{cs}	I_{cu}	I_{cs}			I_{cu}	I_{cs}	I_{cu}	I_{cs}
GLE	3, 4	65	65	35	35	35	18	12	9	22	22
GLS	3, 4	85	85	50	50	50	25	20	10	22	22
GLH	3, 4	100	100	70	70	65	35	25	13	42	42
GLC	3, 4	200	150	100	75	100	50	35	18	42	42

Table 32. Complete Breaker (Includes Frame, Trip Unit, End Caps and Mounting Hardware) ①

Ampere Rating	3-Pole ②		4-Pole (0%) ③		3-Pole ②		4-Pole (0%) ③		
	Fixed Thermal Adj. Magnetic	Adj. Thermal Adj. Magnetic ④⑤	Fixed Thermal Adj. Magnetic	Adj. Thermal Adj. Magnetic ④⑤	Fixed Thermal Adj. Magnetic	Adj. Thermal Adj. Magnetic ④⑤	Fixed Thermal Adj. Magnetic	Adj. Thermal Adj. Magnetic ④⑤	
IC Rating: 35 kAIC at 415 and 480 Vac					IC Rating: 50 kAIC at 415 and 480 Vac				
250	GLE3250FAM	GLE3250AAM	GLE4250FAM	GLE4250AAM	GLS3250FAM	GLS3250AAM	GLS4250FAM	GLS4250AAM	
300	GLE3300FAM	—	GLE4300FAM	—	GLS3300FAM	—	GLS4350FAM	—	
320	—	GLE3320AAM	—	GLE4320AAM	—	GLS3320AAM	—	GLS4320AAM	
350	GLE3350FAM	—	GLE4350FAM	—	GLS3350FAM	—	GLS4350FAM	—	
400	GLE3400FAM	GLE3400AAM	GLE4400FAM	GLE4400AAM	GLS3400FAM	GLS3400AAM	GLS4400FAM	GLS4400AAM	
500	GLE3500FAM	GLE3500AAM	GLE4500FAM	GLE4500AAM	GLS3500FAM	GLS3500AAM	GLS4500FAM	GLS4500AAM	
600	GLE3600FAM	—	GLE4600FAM	—	GLS3600FAM	—	GLS4600FAM	—	
630 ④	—	GLE3630AAM	—	GLE4630AAM	—	GLS3630AAM	—	GLS4630AAM	
IC Rating: 70 kAIC at 415 Vac, 65 kAIC at 480 Vac					IC Rating: 100 kAIC at 415 and 480 Vac				
250	GLH3250FAM	GLH3250AAM	GLH4250FAM	GLH4250AAM	GLC3250FAM	GLC3250AAM	GLC4250FAM	GLC4250AAM	
300	GLH3300FAM	—	GLH4300FAM	—	GLC3300FAM	—	GLC4300FAM	—	
320	—	GLH3320AAM	—	GLH4320AAM	—	GLC3320AAM	—	GLC4320AAM	
350	GLH3350FAM	—	GLH4350FAM	—	GLC3350FAM	—	GLC4350FAM	—	
400	GLH3400FAM	GLH3400AAM	GLH4400FAM	GLH4400AAM	GLC3400FAM	GLC3400AAM	GLC4400FAM	GLC4400AAM	
500	GLH3500FAM	GLH3500AAM	GLH4500FAM	GLH4500AAM	GLC3500FAM	GLC3500AAM	GLC4500FAM	GLC4500AAM	
600	GLH3600FAM	—	GLH4600FAM	—	GLC3600FAM	—	GLC4600FAM	—	
630 ④	—	GLH3630AAM	—	GLH4630AAM	—	GLC3630AAM	—	GLC4630AAM	

- ① Replace suffix “M” with “W” for no line and load terminals. Replace suffix “M” with “G” for standard cable terminals included.
- ② For 2-pole applications, use two outer poles.
- ③ Neutral protection is indicated by the fourth character: 4 = 0%, 7 = 100%, 8 = adjustable 0 – 60% and 9 = 0 – 100%. 4-pole ground fault option does not have neutral protection.
- ④ 630 amperes is not NEMA rated. 600 amperes is the maximum NEMA rating for the GL.
- ⑤ Adjustable thermal units are typically used in IEC markets and are not NEMA rated.

Table 33. Thermal Magnetic Trip Unit

Ampere Rating	3-Pole ⑥		4-Pole (0%) ⑦	
	Fixed Thermal/ Adj. Magnetic	Adj. Thermal/ Adj. Magnetic ⑧	Fixed Thermal/ Adj. Magnetic	Adj. Thermal/ Adj. Magnetic ⑧
250	LT3250FA	LT3250AA	LT4250FA	LT4250AA
300	LT3300FA	—	LT4300FA	—
320	—	LT3320AA	—	LT4320AA
350	LT3350FA	—	LT4350FA	—
400	LT3400FA	LT3400AA	LT4400FA	LT4400AA
500	LT3500FA	LT3500AA	LT4500FA	LT4500AA
600	LT3600FA	—	LT4600FA	—
630	—	LT3630AA	—	LT4630AA

- ⑥ For 2-pole applications, use two outer poles.
- ⑦ Neutral protection is indicated by the third character: 4 = 0%, 7 = 100%, 8 = adjustable 0 – 60% and 9 = 0 – 100%. 4-pole ground fault option does not have neutral protection.
- ⑧ Adjustable thermal, adjustable magnetic trip units are typically used in IEC markets and are not NEMA rated.

Table 34. Moulded Case Switches

Ampere Rating	Number of Poles	Catalogue Number
400	3 ⑨	GLK3400KSM
	4	GLK4400KSM
630 ⑩	3 ⑨	GLK3630KSM
	4	GLK4630KSM

- ⑨ For 2-pole applications, use two outer poles.
- ⑩ 630 amperes is not NEMA rated. 600 amperes is the maximum NEMA rating for the GL.

Table 35. Components Frame

Ampere Rating ⑪	IC Rating at 415/480 V	3-Pole ⑫	4-Pole (0%)
630	35/35	GLE3630NN	GLE4630NN
630	50/50	GLS3630NN	GLS4630NN
630	70/65	GLH3630NN	GLH4630NN
630	100/100	GLC3630NN	GLC4630NN

- ⑪ 630 amperes is not NEMA rated. 600 amperes is the maximum NEMA rating for the GL.
- ⑫ For 2-pole applications, use two outer poles.

Frame Size GL, 630 Amperes (600 Amperes NEMA)
Table 36. Electronic Trip Units — Digitrip 310+

Ampere Rating	LS	LSI	LSG	LSIG	Neutral CT for LSG & LSIG ①
3-Pole					
250	LT325033	LT325032	LT325035	LT325036	LGFACT250
400	LT340033	LT340032	LT340035	LT340036	LGFACT400
600	LT360033	LT360032	LT360035	LT360036	LGFACT600
630 ②	LT363033	LT363032	LT363035	LT363036	LGFACT630
4-Pole ③					
250	LT425033	LT425032	LT425035	LT425036	LGFACT250
400	LT440033	LT440032	LT440035	LT440036	LGFACT400
600	LT460033	LT460032	LT460035	LT460036	LGFACT600
630 ②	LT463033	LT463032	LT463035	LT463036	LGFACT630

① Required for 4-wire systems if neutral protection is desired.

② 630 amperes is not NEMA rated. 600 amperes is the maximum NEMA rating for the GL.

③ Neutral protection: 4 = 0%, 6 = 60%, 7 = 100%. Electronic trip unit neutral protection is not adjustable. 4-pole ground fault option does not have neutral protection.

Note: Long time pickup — no rating plug needed.

630 Ampere Settings — 630, 600, 500, 400, 350, 315, 300, 250 (315, 630 are IEC ratings only).

600 Ampere Settings — 600, 500, 450, 400, 350, 315, 300, 250 (315 is IEC rating only).

400 Ampere Settings — 400, 350, 315, 300, 250, 225, 200, 160 (315 is IEC rating only).

250 Ampere Settings — 250, 225, 200, 175, 160, 150, 125, 100 (160 is IEC rating only).

Note: Adjustable long time delay — 2 – 24 seconds at $6 \times I_r$.

Adjustable short time delay — Inst., 120, 300 ms.

Note: Plug-in test kit — Catalogue Numbers **MTST120V** (120 Vac) and **MTST230V** (230 Vac).

Digitrip 310+ Test Kit

Digitrip 310+ Test Kit Shown with GJ MCCB

GL Digitrip 310+ Electronic Trip Unit

**Table 37. IC Rating at 415/480 V — Complete GL Breakers with Electronic Trip Unit
(Includes Frame, Trip Unit, Standard Terminals and Mounting Hardware) ①**

Ampere Rating	LS	LSI	LSG	LSIG	Neutral CT for LSG & LSIG ②
3-Pole ③ — IC Rating: 35 kAIC at 415 and 480 Vac					
250	GLE325033M	GLE325032M	GLE325035M	GLE325036M	LGFACT250
400	GLE340033M	GLE340032M	GLE340035M	GLE340036M	LGFACT400
600	GLE360033M	GLE360032M	GLE360035M	GLE360036M	LGFACT600
630 ④	GLE363033M	GLE363032M	GLE363035M	GLE363036M	LGFACT630
4-Pole ⑤ — IC Rating: 35 kAIC at 415 and 480 Vac					
250	GLE425033M	GLE425032M	GLE425035M	GLE425036M	LGFACT250
400	GLE440033M	GLE440032M	GLE440035M	GLE440036M	LGFACT400
600	GLE460033M	GLE460032M	GLE460035M	GLE460036M	LGFACT600
630 ④	GLE463033M	GLE463032M	GLE463035M	GLE463036M	LGFACT630
3-Pole ③ — IC Rating: 50 kAIC at 415 and 480 Vac					
250	GLS325033M	GLS325032M	GLS325035M	GLS325036M	LGFACT250
400	GLS340033M	GLS340032M	GLS340035M	GLS340036M	LGFACT400
600	GLS360033M	GLS360032M	GLS360035M	GLS360036M	LGFACT600
630 ④	GLS363033M	GLS363032M	GLS363035M	GLS363036M	LGFACT630
4-Pole ⑤ — IC Rating: 50 kAIC at 415 and 480 Vac					
250	GLS425033M	GLS425032M	GLS425035M	GLS425036M	LGFACT250
400	GLS440033M	GLS440032M	GLS440035M	GLS440036M	LGFACT400
600	GLS460033M	GLS460032M	GLS460035M	GLS460036M	LGFACT600
630 ④	GLS463033M	GLS463032M	GLS463035M	GLS463036M	LGFACT630
3-Pole ③ — IC Rating: 70 kAIC at 415 Vac, 65 kAIC at 480 Vac					
250	GLH325033M	GLH325032M	GLH325035M	GLH325036M	LGFACT250
400	GLH340033M	GLH340032M	GLH340035M	GLH340036M	LGFACT400
600	GLH360033M	GLH360032M	GLH360035M	GLH360036M	LGFACT600
630 ④	GLH363033M	GLH363032M	GLH363035M	GLH363036M	LGFACT630
4-Pole ⑤ — IC Rating: 70 kAIC at 415 Vac, 65 kAIC at 480 Vac					
250	GLH425033M	GLH425032M	GLH425035M	GLH425036M	LGFACT250
400	GLH440033M	GLH440032M	GLH440035M	GLH440036M	LGFACT400
600	GLH460033M	GLH460032M	GLH460035M	GLH460036M	LGFACT600
630 ④	GLH463033M	GLH463032M	GLH463035M	GLH463036M	LGFACT630

- ① Replace suffix "M" with "W" for no line and load terminals. Replace suffix "M" with "G" for standard cable terminals included.
- ② Required for 4-wire systems if neutral protection is desired.
- ③ For 2-pole applications, use two outer poles.
- ④ 630 amperes is not NEMA rated. 600 amperes is the maximum NEMA rating for the GL.
- ⑤ Neutral protection: 4= 0%, 6 = 60%, 7 = 100%. Electronic trip unit neutral protection is not adjustable. 4-pole with ground fault option does not have neutral protection.

Frame Size GL, 630 Amperes (600 Amperes NEMA)

Line and Load Terminals

Table 38. Line and Load Terminals

Maximum Breaker Amperes	Terminal Body Material	Wire Type	AWG Wire Range/ Number of Conductors	Metric Wire Range (mm ²)	Number of Terminals Included	Catalogue Number
400	Aluminum	Cu/Al	500 – 750 (1)	240 – 380 (1)	3	3TA631LK ①
400	Aluminum	Cu/Al	500 – 750 (1)	240 – 380 (1)	4	4TA631LK ①
400	Copper	Cu	500 – 750 (1)	240 – 380 (1)	3	3T631LK ①
400	Copper	Cu	500 – 750 (1)	240 – 380 (1)	4	4T631LK ①
630	Aluminum	Cu/Al	2 – 500 (2)	35 – 240 (2)	3	3TA632LK ①②
630	Aluminum	Cu/Al	2 – 500 (2)	35 – 240 (2)	4	4TA632LK ①②
630	Copper	Cu	2 – 500 (2)	35 – 240 (2)	3	3T632LK ①
630	Copper	Cu	2 – 500 (2)	35 – 240 (2)	4	4T632LK ①
400	Aluminum	Cu/Al	2 – 500 (1)	35 – 240 (1)	1	TA350LK ②
400	Copper	Cu	2 – 500 (1)	35 – 240 (1)	1	T350LK

① Includes LTS3K (3-pole) or LTS4K (4-pole) terminal covers.
② Standard terminal included with complete breaker.

Table 39. Terminal Covers

Description	Catalogue Number
3-Pole Terminal Cover ③	LTS3K
4-Pole Terminal Cover ③	LTS4K

③ Included in TA631L, T631L, TA632L kits listed above.

Table 40. End Cap Kits

Number of Poles	Catalogue Number
3	L3RTWK
4	L4RTWK

Table 41. Terminal Extensions

Number of Poles	Catalogue Number
3	LGTEW3
4	LGTEW4

Table 42. Terminal Spreaders

Number of Poles	Catalogue Number
3	LGTES3
4	LGTES4

Table 43. Interphase Barriers

Description	Catalogue Number
3 (Pack of 2)	IPB3
4 (Pack of 3)	IPB34

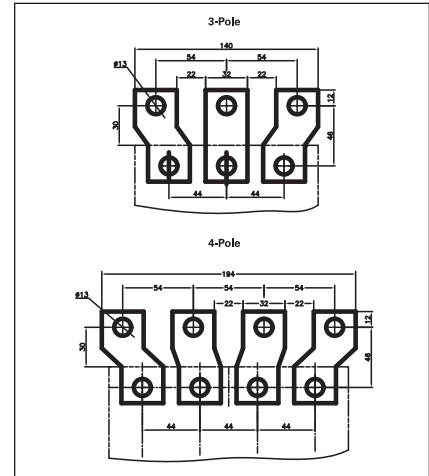

Figure 11. Terminal Spreaders

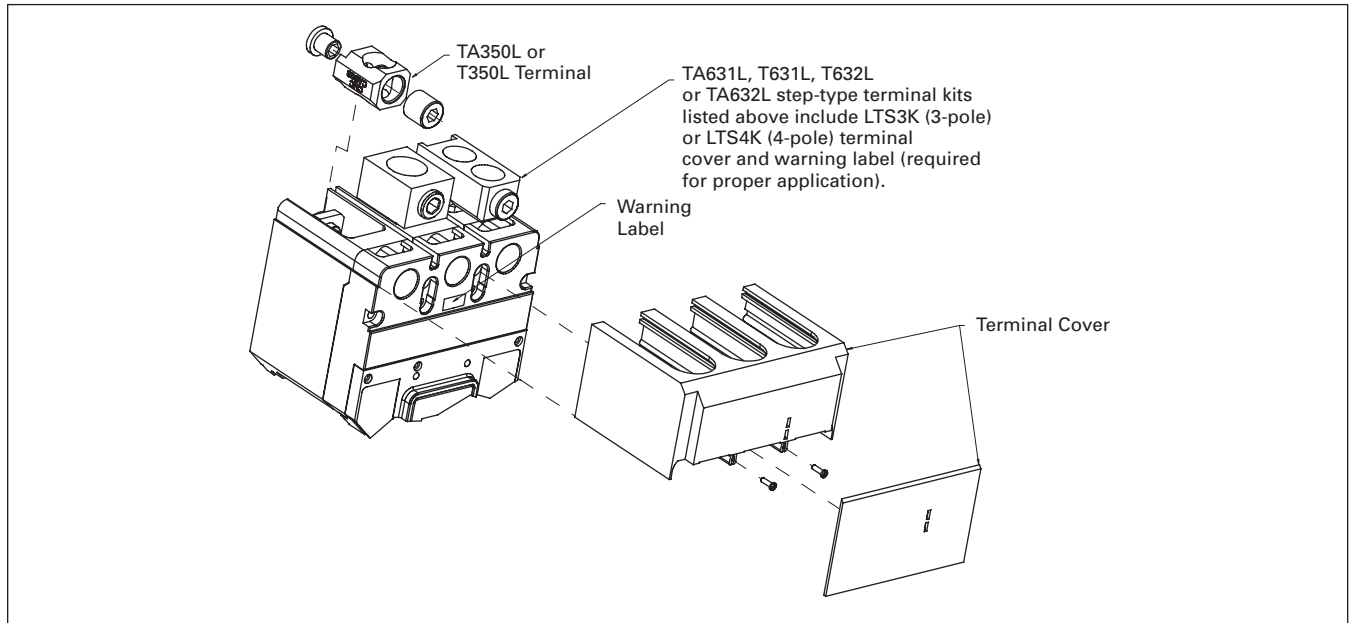

Figure 12. Terminals and Terminal Cover for the GL Breaker — Includes LTS3K (3-Pole) or LTS4K (4-Pole) Terminal Covers

Note: Extended terminal covers add 54.0 mm (2.13 inches) to breaker length.

GN-Frame



GN Frame

1250 Amperes — Selection Guide and Ordering Information

Table 44. UL 489/IEC 60947-2 Interrupting Capacity Ratings

Circuit Breaker Type	Number of Poles	Interrupting Capacity (kA Symmetrical Amperes)									
		Volts ac (50/60 Hz)								Volts dc	
		220 – 240 Vac		380 – 415 Vac		480 Vac	600 Vac	690 Vac		250 V	
		I _{cu}	I _{cs}	I _{cu}	I _{cs}			I _{cu}	I _{cs}	I _{cu}	I _{cs}
S	2, 3, 4 ①	85	85	50	50	50	25	20 ②	10	—	—
H	2, 3, 4 ①	100	100	70	50	65	35	25 ②	13	—	—
C ③	2, 3, 4 ①	200	100	100	50	100	50	35	18	—	—

- ① Neutral on right side.
- ② IEC 60947-2 H.5 Annex H is not KEMA-KEUR tested.
- ③ Not KEMA-KEUR listed.

1600 Amperes — Selection Guide and Ordering Information

Table 45. UL 489/IEC 60947-2 Interrupting Capacity Rating

Circuit Breaker Type	Number of Poles	Interrupting Capacity (kA Symmetrical Amperes)									
		Volts ac (50/60 Hz)								Volts dc	
		220 – 240 Vac		380 – 415 Vac		480 Vac	600 Vac	690 Vac		250 V	
		I _{cu}	I _{cs}	I _{cu}	I _{cs}			I _{cu}	I _{cs}	I _{cu}	I _{cs}
S	2, 3, 4 ④	85	85	50	50	50	25	20 ⑤	10	—	—
H	2, 3, 4 ④	100	100	70	50	65	35	25 ⑤	13	—	—

- ④ Neutral on right side.
- ⑤ IEC 60947-2 H.5 Annex H is not KEMA-KEUR tested.

Frame Size GN, 1250 Amperes 50 kA at 480 Vac or 415 Vac

Table 46. Type GNS Standard Interrupting Capacity — U_e Max. 690 Vac, 50 kA I_{CU} at 480 Vac or 415 Vac

Maximum Continuous Ampere Rating at 40°C ①②	Number of Poles	Circuit Breaker Frame Including Digitrip RMS 310 Electronic Trip Unit without Rating Plugs — Catalogue Number ③				Ampere Rating	Must Add Proper Rating Plug Suffix to Complete Breaker		Separate Rating Plugs			
		LS	LSI	LSG	LSIG		Fixed	Adj.	Fixed	Adjustable		
		L – Adj. Long Delay Pickup (By Adj. Rating Plug) S – Adj. Short Delay Pickup with Fixed Short Delay Time (I^2t Response) or Adj. Short Delay Time (Flat Response) I – Adj. Instantaneous Pickup by Setting Short Delay Time to Inst. G – Adj. Ground Fault Pickup with Adj. Ground Fault Delay (Flat Response)										
Short Time Range		2 – 8 x I_n	2 – 8 x I_n	2 – 8 x I_n	2 – 8 x I_n							
Short Time Delay		—	1 – 300 ms	—	1 – 300 ms							
Ground Fault Pickup		—	—	200 – 1200 A	200 – 1200 A							
Ground Fault Delay		—	—	1 – 500 ms	1 – 500 ms							
800	2-Pole	GNS2800T33W	GNS2800T32W	GNS2800T35W	GNS2800T36W	400	P17	400/500/	8NES400T 8NES450T 8NES500T 8NES550T	400/500/ 600/800		
						450	P16	600/800				
						500	P15	P18				
						550	P14					
						600	P13	400/500/			8NES600T 8NES630T 8NES700T 8NES800T	400/500/ 630/800
						630	P12	630/800				
	700	P11	P19									
	800	P10										
	3-Pole	GNS3800T33W	GNS3800T32W	GNS3800T35W	GNS3800T36W	400	P17	400/500/	8NES400T 8NES450T 8NES500T 8NES550T	400/500/ 600/800		
						450	P16	600/800				
						500	P15	P18				
						550	P14					
600						P13	400/500/	8NES600T 8NES630T 8NES700T 8NES800T			400/500/ 630/800	
630						P12	630/800					
700	P11	P19										
800	P10											
4-Pole ④	GNS4800T33W	GNS4800T32W	⑤	⑤	400	P17	400/500/		8NES400T 8NES450T 8NES500T 8NES550T	400/500/ 600/800		
					450	P16	600/800					
					500	P15	P18					
					550	P14						
					600	P13	400/500/	8NES600T 8NES630T 8NES700T 8NES800T			400/500/ 630/800	
					630	P12	630/800					
700	P11	P19										
800	P10											

NEMA GN 1200 with 1200 A Trip Units is Also Available

1250	2-Pole	GNS2125T33W	GNS2125T32W	GNS2125T35W	GNS2125T36W	600	P07	600/800/	12NES600T 12NES630TW 12NES700T 12NES800T	600/800/ 1000/1200		
						630	P06	1000/1200				
						700	P05	P08				
						800	P04					
						900	P20	630/800/			12NES900T 12NES1000T 12NES1200T 12NES1250TW	630/800/ 1000/1250
						1000	P03	1000/1250				
	1200	P02	P09									
	1250	P01										
	3-Pole	GNS3125T33W	GNS3125T32W	GNS3125T35W	GNS3125T36W	600	P07	600/800/	12NES600T 12NES630TW 12NES700T 12NES800T	600/800/ 1000/1200		
						630	P06	1000/1200				
						700	P05	P08				
						800	P04					
900						P20	630/800/	12NES900T 12NES1000T 12NES1200T 12NES1250TW			630/800/ 1000/1250	
1000						P03	1000/1250					
1200	P02	P09										
1250	P01											
4-Pole ④	GNS4125T33W	GNS4125T32W	⑤	⑤	600	P07	600/800/		12NES600T 12NES630TW 12NES700T 12NES800T	600/800/ 1000/1200		
					630	P06	1000/1200					
					700	P05	P08					
					800	P04						
					900	P20	630/800/	12NES900T 12NES1000T 12NES1200T 12NES1250TW			630/800/ 1000/1250	
					1000	P03	1000/1250					
1200	P02	P09										
1250	P01											

① For ac use only.
 ② GN MCCBs are suitable for 40°C or 50°C applications. Order suffix V3 to eliminate standard 40°C labeling.
 ③ Order terminals separately.
 ④ Unprotected left pole neutral. Insert “E” for 100% neutral or “EH” for 60% neutral between “W” and “P” (e.g., GNS412T32EHP08).
 4-pole with ground fault option does not have neutral protection.
 ⑤ Contact Eaton for availability.
Note: GN MCCBs have metric threading on line and load conductors. Use ND MCCBs if imperial threading is required.

Table 47. Moulded Case Switches ⑥⑦

Ampere Rating	Number of Poles	U_e Max. 690 Vac Catalogue Number	
800	3-Pole	GNK3800KSW	MCS Only without Line and Load Terminals
	4-Pole	GNK4800KSW	
1250	3-Pole	GNK312KSW	MCS Only without Line and Load Terminals
	4-Pole	GNK412KSW	

⑥ For ac use only.
 ⑦ For 2-pole applications, use outer poles of 3-pole moulded case switch.

Table 48. Type GNH High Interrupting Capacity — U_g Max. 690 Vac, 65 kA I_{CU} at 480 Vac, 70 kA I_{CU} at 415 Vac

Maximum Continuous Ampere Rating at 40°C ①②	Number of Poles	Circuit Breaker Frame Including Digitrip RMS 310 Electronic Trip Unit without Rating Plugs — Catalogue Number ③				Ampere Rating	Must Add Proper Rating Plug Suffix to Complete Breaker		Separate Rating Plugs	
		LS	LSI	LSG	LSIG		Fixed	Adj.	Fixed	Adjustable
		L – Adj. Long Delay Pickup (By Adj. Rating Plug) S – Adj. Short Delay Pickup with Fixed Short Delay Time (I^2t Response) or Adj. Short Delay Time (Flat Response) I – Adj. Instantaneous Pickup by Setting Short Delay Time to Inst. G – Adj. Ground Fault Pickup with Adj. Ground Fault Delay (Flat Response)								
		2 – 8 x I_n	2 – 8 x I_n I – 300 ms	2 – 8 x I_n — 200 – 1200 A I – 500 ms	2 – 8 x I_n I – 300 ms 200 – 1200 A I – 500 ms					
800	2-Pole	GNH2800T33W	GNH2800T32W	GNH2800T35W	GNH2800T36W	400	P17	400/500/	8NES400T	400/500/
						450	P16	600/800	8NES450T	600/800
						500	P15	P18	8NES500T	A8NES800T1
						550	P14		8NES550T	
	600	P13	400/500/	8NES600T	400/500/					
	630	P12	630/800	8NES630T	630/800					
	700	P11	P19	8NES700T	A8NES800T2					
	800	P10		8NES800T						
	3-Pole	GNH3800T33W	GNH3800T32W	GNH3800T35W	GNH3800T36W	400	P17	400/500/	8NES400T	400/500/
						450	P16	600/800	8NES450T	600/800
						500	P15	P18	8NES500T	A8NES800T1
						550	P14		8NES550T	
600	P13	400/500/	8NES600T	400/500/						
630	P12	630/800	8NES630T	630/800						
700	P11	P19	8NES700T	A8NES800T2						
800	P10		8NES800T							
4-Pole ④	GNH4800T33W	GNH4800T32W	⑤	⑤	400	P17	400/500/	8NES400T	400/500/	
					450	P16	600/800	8NES450T	600/800	
					500	P15	P18	8NES500T	A8NES800T1	
					550	P14		8NES550T		
600	P13	400/500/	8NES600T	400/500/						
630	P12	630/800	8NES630T	630/800						
700	P11	P19	8NES700T	A8NES800T2						
800	P10		8NES800T							

NEMA GN 1200 with 1200 A Trip Units is Also Available

1250	2-Pole	GNH2125T33W	GNH2125T32W	GNH2125T35W	GNH2125T36W	600	P07	600/800/	12NES600T	600/800/
						630	P06	1000/1200	12NES630TW	1000/1200
						700	P05	P08	12NES700T	A12NES1200T1
						800	P04		12NES800T	
	900	P20	630/800/	12NES900T	630/800/					
	1000	P03	1000/1250	12NES1000T	1000/1250					
	1200	P02	P09	12NES1200T	A12NES1250T2					
	1250	P01		12NES1250TW						
	3-Pole	GNH3125T33W	GNH3125T32W	GNH3125T35W	GNH3125T36W	600	P07	600/800/	12NES600T	600/800/
						630	P06	1000/1200	12NES630TW	1000/1200
						700	P05	P08	12NES700T	A12NES1200T1
						800	P04		12NES800T	
900	P20	630/800/	12NES900T	630/800/						
1000	P03	1000/1250	12NES1000T	1000/1250						
1200	P02	P09	12NES1200T	A12NES1250T2						
1250	P01		12NES1250TW							
4-Pole ④	GNH4125T33W	GNH4125T32W	⑤	⑤	600	P07	600/800/	12NES600T	600/800/	
					630	P06	1000/1200	12NES630TW	1000/1200	
					700	P05	P08	12NES700T	A12NES1200T1	
					800	P04		12NES800T		
900	P20	630/800/	12NES900T	630/800/						
1000	P03	1000/1250	12NES1000T	1000/1250						
1200	P02	P09	12NES1200T	A12NES1250T2						
1250	P01		12NES1250TW							

① For ac use only.

② GN MCCBs are suitable for 40°C or 50°C applications. Order suffix V3 to eliminate standard 40°C labeling.

③ Order terminals separately.

④ Unprotected left pole neutral. Insert “E” for 100% neutral or “EH” for 60% neutral between “W” and “P” (e.g., GNS412T32EHP08). 4-pole with ground fault option does not have neutral protection.

⑤ Contact Eaton for availability.

Note: GN MCCBs have metric threading on line and load conductors. Use ND MCCBs if imperial threading is required.

Frame Size GN, 1250 Amperes 100 kA at 480 Vac or 415 Vac

Table 49. Type GNC Very High Capacity — U_e Max. 690 Vac, 100 kA I_{CU} at 480 Vac or 415 Vac

Maximum Continuous Ampere Rating at 40°C ①②	Number of Poles	Circuit Breaker Frame Including Digitrip RMS 310 Electronic Trip Unit without Rating Plugs — Catalogue Number ③				Ampere Rating	Must Add Proper Rating Plug Suffix to Complete Breaker		Separate Rating Plugs	
		LS	LSI	LSG	LSIG		Fixed	Adj.	Fixed	Adjustable
		L – Adj. Long Delay Pickup (By Adj. Rating Plug) S – Adj. Short Delay Pickup with Fixed Short Delay Time (I^2t Response) or Adj. Short Delay Time (Flat Response) I – Adj. Instantaneous Pickup by Setting Short Delay Time to Inst. G – Adj. Ground Fault Pickup with Adj. Ground Fault Delay (Flat Response)								
Short Time Range		2 – 8 x I_n	2 – 8 x I_n	2 – 8 x I_n	2 – 8 x I_n					
Short Time Delay		—	1 – 300 ms	—	1 – 300 ms					
Ground Fault Pickup		—	—	200 – 1200 A	200 – 1200 A					
Ground Fault Delay		—	—	1 – 500 ms	1 – 500 ms					
800	2-Pole	GNC2800T33W	GNC2800T32W	GNC2800T35W	GNC2800T36W	400	P17	400/500/	8NES400T	400/500/
						450	P16	600/800	8NES450T	600/800
						500	P15	P18	8NES500T	A8NES800T1
						550	P14		8NES550T	
	600	P13	400/500/	8NES600T	400/500/					
	630	P12	630/800	8NES630T	630/800					
	700	P11	P19	8NES700T	A8NES800T2					
	800	P10		8NES800T						
	3-Pole	GNC3800T33W	GNC3800T32W	GNC3800T35W	GNC3800T36W	400	P17	400/500/	8NES400T	400/500/
						450	P16	600/800	8NES450T	600/800
						500	P15	P18	8NES500T	A8NES800T1
						550	P14		8NES550T	
600	P13	400/500/	8NES600T	400/500/						
630	P12	630/800	8NES630T	630/800						
700	P11	P19	8NES700T	A8NES800T2						
800	P10		8NES800T							
4-Pole ④	GNC4800T33W	GNC4800T32W	⑤	⑤	400	P17	400/500/	8NES400T	400/500/	
					450	P16	600/800	8NES450T	600/800	
					500	P15	P18	8NES500T	A8NES800T1	
					550	P14		8NES550T		
600	P13	400/500/	8NES600T	400/500/						
630	P12	630/800	8NES630T	630/800						
700	P11	P19	8NES700T	A8NES800T2						
800	P10		8NES800T							

NEMA GN 1200 with 1200 A Trip Units is Also Available

1250	2-Pole	GNC125T33W	GNC125T32W	GNC125T35W	GNC125T36W	600	P07	600/800/	12NES600T	600/800/
						630	P06	1000/1200	12NES630TW	1000/1200
						700	P05	P08	12NES700T	A12NES1200T1
						800	P04		12NES800T	
	900	P20	630/800/	12NES900T	630/800/					
	1000	P03	1000/1250	12NES1000T	1000/1250					
	1200	P02	P09	12NES1200T	A12NES1250T2					
	1250	P01		12NES1250TW						
	3-Pole	GNC3125T33W	GNC3125T32W	GNC3125T35W	GNC3125T36W	600	P07	600/800/	12NES600T	600/800/
						630	P06	1000/1200	12NES630TW	1000/1200
						700	P05	P08	12NES700T	A12NES1200T1
						800	P04		12NES800T	
900	P20	630/800/	12NES900T	630/800/						
1000	P03	1000/1250	12NES1000T	1000/1250						
1200	P02	P09	12NES1200T	A12NES1250T2						
1250	P01		12NES1250TW							
4-Pole ④	GNC4125T33W	GNC4125T32W	⑤	⑤	600	P07	600/800/	12NES600T	600/800/	
					630	P06	1000/1200	12NES630TW	1000/1200	
					700	P05	P08	12NES700T	A12NES1200T1	
					800	P04		12NES800T		
900	P20	630/800/	12NES900T	630/800/						
1000	P03	1000/1250	12NES1000T	1000/1250						
1200	P02	P09	12NES1200T	A12NES1250T2						
1250	P01		12NES1250TW							

① For ac use only.

② GN MCCBs are suitable for 40°C or 50°C applications. Order suffix V3 to eliminate standard 40°C labeling.

③ Order terminals separately.

④ Unprotected left pole neutral. Insert "E" for 100% neutral or "EH" for 60% neutral between "W" and "P" (e.g., GNS412T32EHP08). 4-pole with ground fault option does not have neutral protection.

⑤ Contact Eaton for availability.

Note: GN MCCBs have metric threading on line and load conductors. Use ND MCCBs if imperial threading is required.

Table 50. Type GNS and GNH Standard and High Interrupting Capacity — U_e Max. 690 Vac, 50 kA I_{CU} /70 kA I_{CU} at 415 Vac

Maximum Continuous Ampere Rating at 40°C ^{①②}	Number of Poles	Circuit Breaker Frame Including Digitrip RMS 310 Electronic Trip Unit and Adjustable Rating Plugs				Adjustable Rating Plug
		LS	LSI	LSG	LSIG	
		L – Adjustable Long Delay Pickup (By Adjustable Rating Plug) S – Adjustable Short Delay Pickup with Fixed Short Delay Time (I ² t Response) or Adjustable Short Delay Time (Flat Response) I – Adjustable Instantaneous Pickup by Setting Short Delay Time to Instantaneous G – Adjustable Ground Fault Pickup with Adjustable Ground Fault Delay (Flat Response)				
Short Time Range		2 – 8 × I _n	2 – 8 × I _n	2 – 8 × I _n	2 – 8 × I _n	
Short Time Delay		—	1 – 300 ms	—	1 – 300 ms	
Ground Fault Pickup		—	—	200 – 1200 A	200 – 1200 A	
Ground Fault Delay		—	—	1 – 500 ms	1 – 500 ms	
1600 ^③	3-Pole 4-Pole ^④	GNS316T33WP35 GNS416T33WP35	GNS316T32WP35 GNS416T32WP35	GNS316T35WP35 ^⑤	GN316T36WP35 ^⑤	800/1000/1250/1600
1600	3-Pole 4-Pole	GNH316T33WP35 GNH416T33WP35	GNH316T32WP35 GNH416T32WP35	GNH316T35WP35 ^⑤	GNHS316T36WP35 ^⑤	800/1000/1250/1600

- ① For ac use only.
- ② GN MCCBs are suitable for 40°C or 50°C applications. Order suffix V3 to eliminate standard 40°C labeling.
- ③ No UL or CSA label is available for the 1600 ampere frame size.
- ④ Unprotected left pole neutral. Insert “1” for 100% protected neutral or “6” for 60% protected neutral before “WP” suffix (e.g., GNS416T336WP35). 4-pole with ground fault option does not have neutral protection.
- ⑤ Contact Eaton for availability.

Note: GN 1600 MCCB uses metric threading on line and load conductors. The GN 1600 is not NEMA rated.

Line and Load Terminals

N-Frame circuit breakers do not include terminals as standard. When copper or Cu/Al terminals are required, order by catalogue number.

Table 51. Line and Load Terminals

Maximum Breaker Amperes	Terminal Body Material	Wire Type	Metric Wire Range mm ²	AWG Wire Number of Conductors	Catalogue Number ^⑥
Standard Cu/Al Pressure-Type Terminals					
1250 ^⑦	Aluminum	Cu/Al	120 – 300	4/0 – 500 (3)	TA1200NB3M
Optional Copper and Cu/Al Pressure Type Terminals					
1250 ^⑦	Copper	Copper	95 – 185	3/0 – 400 (4)	T1200NB3M

- ⑥ Single terminals individually packed.
- ⑦ Not suitable with 1600 ampere frame version.

Terminal Extensions

Table 52. Terminal Extensions

Maximum Breaker Amperes	Number of Poles	Catalogue Number
800	3	GN8TES3
800	4	GN8TES4
1600	3	GN16TES3
1600	4	GN16TES4

Base Mounting Hardware

Base mounting hardware is included with a circuit breaker or Moulded case switch.

Table 53. Base Mounting Hardware

Number of Poles	Description	Catalogue Number
2-, 3- and 4-pole	Imperial Hardware: .3125 – 18 x 1.25 Pan-Head Steel Screws and Lock Washers	BMH5
2-, 3- and 4-pole	Metric Hardware: M8 Pan-Head Steel Screws and Lock Washers	BMH5M

Keeper Nut

Not required on N-Frame. Terminals are threaded.

Handle Extension

Included with breaker. Additional handle extensions are available.

Table 54. Handle Extension

Description	Catalogue Number
Single Handle Extension	HEX5

Interphase Barriers

The interphase barriers provide additional electrical clearance between circuit breaker poles for special termination applications. Barriers are high dielectric insulating plates that are installed in the Moulded slots between the terminals. (Field installation only.)

Table 55. Interphase Barriers

Description	Catalogue Number
3 (Pack of 2)	IPB5
4 (Pack of 3)	IPB54

GR-Frame, 2500 Amperes — Selection Guide and Ordering Information



GR Frame

Table 56. UL 489/IEC 60947-2 Interrupting Capacity Ratings

Circuit Breaker Type	Number of Poles	Interrupting Capacity (kA Symmetrical Amperes)									
		Volts ac (50/60 Hz)								Volts dc	
		220 – 240 Vac		380 – 415 Vac		480 Vac	600 Vac	690 Vac		250 V	
		I_{cu}	I_{cs}	I_{cu}	I_{cs}			I_{cu}	I_{cs}	I_{cu}	I_{cs}
H	3, 4 ①	135	100	70	50	65	50	25 ②	13	—	—
C ③	3, 4 ①	200	100	100	50	100	65	35 ②	18	—	—

① Neutral on right side.

② IEC 60947-2 H.5 Annex H is not KEMA-KEUR tested.

③ Not KEMA-KEUR listed.

Table 57. Type GRH with Digitrip 310 High Interrupting Capacity — U_e Max. 690 Vac, 70 kA I_{CU} at 415 Vac

Maximum Continuous Ampere Rating at 40°C ①	Number of Poles	Circuit Breaker Frame Including Digitrip RMS 310 Electronic Trip Unit without Rating Plugs — Catalogue Number ②				Ampere Rating	Must Add Proper Rating Plug Suffix to Complete Breaker		Separate Rating Plugs	
		LS	LSI	LSG ③	LSIG ④		Fixed	Adj.	Fixed	Adj.
		L – Adj. Long Delay Pickup (By Adj. Rating Plug) S – Adj. Short Delay Pickup with Fixed Short Delay Time (I^2t Response) or Adj. Short Delay Time (Flat Response) I – Adj. Inst. Pickup by Setting Short Delay Time to Instantaneous G – Adj. Ground Fault Pickup with Adj. Ground Fault Delay (Flat Response)								
Short Time Range		2 – 8 x I_n	2 – 8 x I_n	2 – 8 x I_n	2 – 8 x I_n					
Short Time Delay		—	1 – 300 ms	—	1 – 300 ms					
Ground Fault Pickup		—	—	200 – 1200 A	200 – 1200 A					
Ground Fault Delay		—	—	1 – 500 ms	1 – 500 ms					
1600 ①	3-Pole	GRH316T33W	GRH316T32W	GRH316T35W	GRH316T36W	800	P07	800/1000/	16RES08T	800/1000/
						1000	P06	1200/1600	16RES10T	1200/1600
						1200	P05		16RES12T	A16RES16T1
						1250	P04		16RES125T	
						1400	P03	800/1000/	16RES14T	800/1000/
						1500	P02	1250/1600	16RES15T	1250/1600
						1600	P01	P09	16RES16T	A16RES16T2
2000		GRH320T33W	GRH320T32W	GRH320T35W	GRH320T36W	1000	P15	1000/1200/	20RES10T	1000/1200/
						1200	P14	1600/2000	20RES12T	1600/2000
						1250	P13	P16	A20RES125T	A20RES20T1
						1400	P12	1000/1250/	A20RES14T	1000/1250/
						1600	P11	1600/2000	A20RES16T	1600/2000
						2000	P10	P17	A20RES20T	A20RES20T2
2500		GRH325T33W	GRH325T32W	GRH325T35W	GRH325T36W	1200	P34	1200/1600/	25RES12T	1200/1600/
						1250	P35	2000/2500	25RES125T	2000/2500
						1600	P36	P39	A25RES16T	A25RES25T1
						2000	P37	1250/1600/	A25RES20T	1250/1600/
						2500	P38	2000/2500	A25RES25T	2000/2500
							P40		A25RES25T2	A25RES25T2
1600 ①	4-Pole ④	GRH416T33W	GRH416T32W	⑤	⑤	800	P07	800/1000/	16RES08T	800/1000/
						1000	P06	1200/1600	16RES10T	1200/1600
						1200	P05		16RES12T	A16RES16T1
						1250	P04		16RES125T	
						1400	P03	800/1000/	16RES14T	800/1000/
						1500	P02	1250/1600	16RES15T	1250/1600
						1600	P01	P09	16RES16T	A16RES16T2
2000		GRH420T33W	GRH420T32W	⑤	⑤	1000	P15	1000/1200/	20RES10T	1000/1200/
						1200	P14	1600/2000	20RES12T	1600/2000
						1250	P13	P16	A20RES125T	A20RES20T1
						1400	P12	1000/1250/	A20RES14T	1000/1250/
						1600	P11	1600/2000	A20RES16T	1600/2000
						2000	P10	P17	A20RES20T	A20RES20T2
2500		GRH425T33W	GRH425T32W	⑤	⑤	1200	P34	1200/1600/	25RES12T	1200/1600/
						1250	P35	2000/2500	25RES125T	2000/2500
						1600	P36	P39	A25RES16T	A25RES25T1
						2000	P37	1250/1600/	A25RES20T	1250/1600/
						2500	P38	2000/2500	A25RES25T	2000/2500
							P40		A25RES25T2	A25RES25T2

① For SCR application, use 2000 ampere frame.
 ② Order terminals separately. Mounting hardware not included.
 ③ Ground fault equipped trip units available with remote indicating panel. Add "R" to catalogue number, e.g., "GRH316T35RW."
 ④ Unprotected left pole neutral. Add "P" to catalogue number for 100% protected left pole neutral, add "E" for 60% protected, e.g., "GRH416T33PW", "GRH416T33EW."
 ⑤ Contact Eaton for availability.

Note: GR MCCBs have metric threading on line and load conductors. Use RD MCCBs if imperial threading is required.

Frame Size GR, 2500 Amperes 100 kA at 480 Vac, 415 Vac — Digitrip 310 Trip Unit

Table 58. Type GRC with Digitrip 310 Very High Interrupting Capacity — U_e Max. 690 Vac, 100 kA I_{cu} at 415 Vac

Maximum Continuous Ampere Rating at 40°C ①	Number of Poles	Circuit Breaker Frame Including Digitrip RMS 310 Electronic Trip Unit without Rating Plugs — Catalogue Number ②				Ampere Rating	Must Add Proper Rating Plug Suffix to Complete Breaker		Separate Rating Plugs	
		LS	LSI	LSG ③	LSIG ③		Fixed	Adj.	Fixed	Adj.
		L – Adj. Long Delay Pickup (By Adj. Rating Plug) S – Adj. Short Delay Pickup with Fixed Short Delay Time (I ² t Response) or Adj. Short Delay Time (Flat Response) I – Adj. Inst. Pickup by Setting Short Delay Time to Inst. G – Adj. Ground Fault Pickup with Adj. Ground Fault Delay (Flat Response)								
Short Time Range Short Time Delay Ground Fault Pickup Ground Fault Delay		2 – 8 x I _n — — —	2 – 8 x I _n I – 300 ms — —	2 – 8 x I _n — 200 – 1200 A I – 500 ms	2 – 8 x I _n I – 300 ms 200 – 1200 A I – 500 ms					
1600 ①	3-Pole	GRC316T33W	GRC316T32W	GRC316T35W	GRC316T36W	800	P07	800/1000/1200/1600	16RES08T	800/1000/1200/1600
						1000	P06		16RES10T	
						1200	P05		16RES12T	A16RES16T1
						1250	P04		16RES125T	
						1400	P03	800/1000/1250/1600	16RES14T	800/1000/1250/1600
						1500	P02		16RES15T	
						1600	P01		16RES16T	A16RES16T2
2000		GRC320T33W	GRC320T32W	GRC320T35W	GRC320T36W	1000	P15	1000/1200/1600/2000	20RES10T	1000/1200/1600/2000
						1200	P14		20RES12T	
						1250	P13		A20RES125T	A20RES20T1
						1400	P12	1000/1250/1600/2000	A20RES14T	1000/1250/1600/2000
						1600	P11		A20RES16T	
						2000	P10		A20RES20T	A20RES20T2
2500 ④		GRC325T33W	GRC325T32W	GRC325T35W	GRC325T36W	1200	P34	1200/1600/2000/2500	25RES12T	1200/1600/2000/2500
						1250	P35		25RES125T	
						1600	P36		A25RES16T	A25RES25T1
						2000	P37	1250/1600/2000/2500	A25RES20T	1250/1600/2000/2500
						2500	P38		A25RES25T	
							P40		A25RES25T2	
1600 ①	4-Pole ⑤	GRC416T33W	GRC416T32W	④	④	800	P07	800/1000/1200/1600	16RES08T	800/1000/1200/1600
						1000	P06		16RES10T	
						1200	P05		16RES12T	A16RES16T1
						1250	P04		16RES125T	
						1400	P03	800/1000/1250/1600	16RES14T	800/1000/1250/1600
						1500	P02		16RES15T	
						1600	P01		16RES16T	A16RES16T2
2000		GRC420T33W	GRC420T32W	④	④	1000	P15	1000/1200/1600/2000	20RES10T	1000/1200/1600/2000
						1200	P14		20RES12T	
						1250	P13		A20RES125T	A20RES20T1
						1400	P12	1000/1250/1600/2000	A20RES14T	1000/1250/1600/2000
						1600	P11		A20RES16T	
						2000	P10		A20RES20T	A20RES20T2
2500 ④		GRC425T33W	GRC425T32W	④	④	1200	P34	1200/1600/2000/2500	25RES12T	1200/1600/2000/2500
						1250	P35		25RES125T	
						1600	P36		A25RES16T	A25RES25T1
						2000	P37	1250/1600/2000/2500	A25RES20T	1250/1600/2000/2500
						2500	P38		A25RES25T	
							P40		A25RES25T2	

- ① For SCR application, use 2000 ampere frame.
- ② Order terminals separately. Mounting hardware not included.
- ③ Ground fault equipped trip units available with remote indicating panel. Add "R" to catalogue number, e.g., "GRH316T35RW."
- ④ Contact Eaton for availability.
- ⑤ Unprotected left pole neutral. Add "P" to catalogue number for 100% protected left pole neutral, add "E" for 60% protected, e.g., "GRH416T33PW", "GRH416T33EW."

Note: GR MCCBs have metric threading on line and load conductors. Use RD MCCBs if imperial threading is required.

Table 59. Moulded Case Switches

Ampere Rating	Number of Poles	Catalogue Number
1600 2000	3-Pole	GRK316WK GRK320WK
1600 2000	4-Pole	GRK416WK GRK420WK

Table 60. Type GR with Digitrip 610 and 910

Maximum Continuous Ampere Rating at 40°C	Number of Poles	Circuit Breaker Frame Including Digitrip RMS 610 and 910 Electronic Trip Unit with Adjustable Rating Plugs Order as Individual Component — Catalogue Number ①					Digitrip RMS Interchangeable Rating Plug (Order as Individual Component)		
		L – Adjustable Long Delay Pickup (I_p) with Adjustable Long Delay Time	S – Adjustable Short Delay Pickup with Adjustable Short Delay Time (I^2t or Flat Response)	I – Adjustable Instantaneous Pickup	G – Adjustable Ground Fault Pickup with Adjustable Ground Fault Time Delay (I^2t or Flat Response)				
		LI	LS	LSI	LIG	LSG	LSIG	Fixed Rating Plug	
Long Delay Pickup	0.5 – 1.0 x I_n	0.5 – 1.0 I_n	0.5 – 1.0 x I_n	0.5 – 1.0 x I_n	0.5 – 1.0 x I_n	0.5 – 1.0 x I_n	0.5 – 1.0 x I_n	Ampere Rating	Catalogue Number
Long Delay Time	2 – 24 Seconds	2 – 24 Seconds	2 – 24 Seconds	2 – 24 Seconds	2 – 24 Seconds	2 – 24 Sec.	2 – 24 Seconds		
Short Time Range	2 – 6 x I_r	2 – 6 x I_r	2 – 6 x I_r	2 – 6 x I_r	2 – 6 x I_r	2 – 6 x I_r	2 – 6 x I_r		
Short Time Delay	—	100 – 500 ms	100 – 500 ms	100 – 500 ms	—	100 – 500 ms	100 – 500 ms		
Instantaneous	2 – 6 x M1 & M2	—	2 – 6 x M1 & M2	2 – 6 x M1 & M2	—	—	2 – 6 x M1 & M2		
Ground Fault Pickup	—	—	—	0.25 – 1.0 x I_n ②	—	0.25 – 1.0 x I_n ②	0.25 – 1.0 x I_n ②		
Ground Fault Delay	—	—	—	100 – 500 ms	—	100 – 500 ms	100 – 500 ms		

Type GRH with Digitrip 610 High Interrupting Capacity — U_g Max. 690 Vac, 70 kA I_{CU} at 415 Vac

1600	3-Pole	GRH316T61WP44	GRH316T63WP44	GRH316T62WP44	GRH316T64WP44	GRH316T65WP44	GRH316T66WP44	800	RP6R16A080
		Includes 1600 A Rating Plug						1000	RP6R16A100
2000		GRH320T61WP49	GRH320T63WP49	GRH320T62WP49	GRH320T64WP49	GRH320T65WP49	GRH320T66WP49	1200	RP6R16A120
		Includes 2000 A Rating Plug						1250	RP6R16A125
2500		GRH325T61WP53	GRH325T63WP53	GRH325T62WP53	GRH325T64WP53	GRH325T65WP53	GRH325T66WP53	1600	RP6R20A160
		Includes 2500 A Rating Plug						2000	RP6R20A200
								2500	RP6R20A250

Type GRC with Digitrip 610 Very High Interrupting Capacity — U_g Max. 690 Vac, 100 kA I_{CU} at 415 Vac

1600	3-Pole	GRC316T61WP44	GRC316T63WP44	GRC316T62WP44	GRC316T64WP44	GRC316T65WP44	GRC316T66WP44	800	RP6R16A080
		Includes 1600 A Rating Plug						1000	RP6R16A100
2000		GRC320T61WP49	GRC320T63WP49	GRC320T62WP49	GRC320T64WP49	GRC320T65WP49	GRC320T66WP49	1200	RP6R16A120
		Includes 2000 A Rating Plug						1250	RP6R16A125
2500 ③		GRC325T61WP53	GRC325T63WP53	GRC325T62WP53	GRC325T64WP53	GRC325T65WP53	GRC325T66WP53	1600	RP6R20A160
		Includes 2500 A Rating Plug						2000	RP6R20A200
								2500	RP6R20A250

Type GRH with Digitrip 910 High Interrupting Capacity — U_g Max. 690 Vac, 70 kA I_{CU} at 415 Vac

1600	3-Pole	GRH316T91WP44	GRH316T93WP44	GRH316T92WP44	GRH316T94WP44	GRH316T95WP44	GRH316T96WP44	800	RP6R16A080
		Includes 1600 A Rating Plug						1000	RP6R16A100
2000		GRH320T91WP49	GRH320T93WP49	GRH320T92WP49	GRH320T94WP49	GRH320T95WP49	GRH320T96WP49	1200	RP6R16A120
		Includes 2000 A Rating Plug						1250	RP6R16A125
2500		GRH325T91WP53	GRH325T93WP53	GRH325T92WP53	GRH325T94WP53	GRH325T95WP53	GRH325T96WP53	1600	RP6R20A160
		Includes 2500 A Rating Plug						2000	RP6R20A200
								2500	RP6R20A250

Type GRC with Digitrip 910 Very High Interrupting Capacity — U_g Max. 690 Vac, 100 kA I_{CU} at 415 Vac

1600	3-Pole	GRC316T91WP44	GRC316T93WP44	GRC316T92WP44	GRC316T94WP44	GRC316T95WP44	GRC316T96WP44	800	RP6R16A080
		Includes 1600 A Rating Plug						1000	RP6R16A100
2000		GRC320T91WP49	GRC320T93WP49	GRC320T92WP49	GRC320T94WP49	GRC320T95WP49	GRC320T96WP49	1200	RP6R16A120
		Includes 2000 A Rating Plug						1250	RP6R16A125
2500 ③		GRC325T91WP53	GRC325T93WP53	GRC325T92WP53	GRC325T94WP53	GRC325T95WP53	GRC325T96WP53	1600	RP6R20A160
		Includes 2500 A Rating Plug						2000	RP6R20A200
								2500	RP6R20A250

① Order terminals separately. Mounting hardware not included.

② Not to exceed 1200 ampere ground fault pickup.

③ Contact Eaton for availability.

Note: GR MCCBs have metric threading on line and load conductors. Use RD MCCBs if imperial threading is required.

Frame Size GR, 800 – 2500 Amperes

Line and Load Terminals

R-Frame circuit breakers use Cu/Al terminals as standard and copper only terminals as an option. Specify if factory installation is required.

Table 61. Line and Load Terminals

Maximum Breaker Amperes	Terminal Body Material	Wire Type	Hardware	AWG/kcmil Wire Range/ Number of Conductors	Metric Wire Range mm ²	Catalogue Number
-------------------------	------------------------	-----------	----------	--	-----------------------------------	------------------

Wire Terminals

1600	Aluminum	Cu/Al	Metric	500 – 1000 (4)	300 – 500	TA1600RDM ①
1600	Copper	Cu	Metric	1 – 600 (4)	50 – 300	T1600RDM ①
2000	Aluminum	Cu/Al	Metric	2 – 600 (6)	35 – 300	TA2000RDM ②

Rear Connectors

2000	Copper	—	Metric	—	—	B2016RDM ①
2000	Copper	—	Metric	—	—	B2016RDLM ①
2500	Copper	—	Metric	—	—	B2500RDM ①

- ① Order one per pole — single terminals individually packed.
- ② Order one TA2000RD kit per 3-poles. Catalogue number includes bus connection, terminals and hardware for either line side or load side of 3-pole breaker.

Note: GR MCCBs have metric threading on line and load conductors. Use RD MCCBs if imperial threading is required.

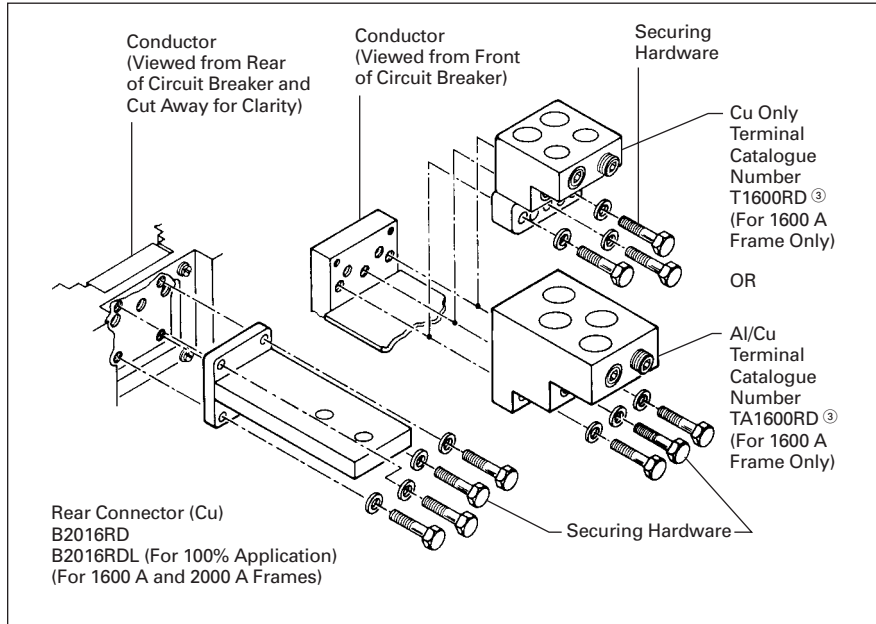

Figure 13. GR Rear Connector Exploded View

- ③ Order one per pole (or two per pole if line and load terminals are required) — single terminals individually packed.

Note: GR MCCBs have metric threading on line and load conductors. Use RD MCCBs if imperial threading is required.

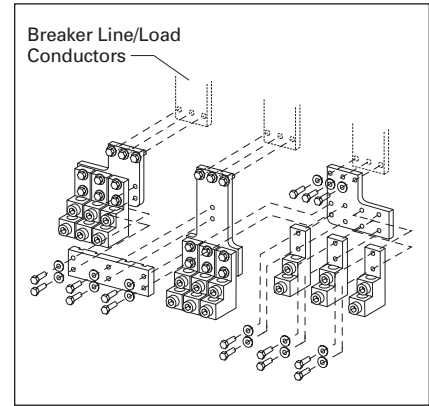

Figure 14. TA2000RD Wire Terminal

Note: Order one TA2000RDM kit per 3-poles. Catalogue number includes bus connection, terminals and hardware for either line side or load side of 3-pole breaker.

Base Mounting Hardware

Supplied by customer.

Handle Extension

Included with breaker. Additional handle extensions are available.

Table 62. Handle Extension

Description	Catalogue Number
Single Handle Extension	HEX6

Motor Circuit Protectors — Selection Guide and Ordering Information

Table 63. GE-Frame — 600Y/347 Vac Maximum, 250 Vdc Maximum ①

Continuous Amperes	Cam Setting	Motor Full Load Current Amperes ②	MCP Trip Setting ③	MCP Catalogue Number
3	A	.69 – .91	9	HMCPE003A0C
	B	1.1 – 1.3	15	
	C	1.6 – 1.7	21	
	D	2.0 – 2.2	27	
	E	2.3 – 2.5	30	
	F	– 2.6	33	
7	A	1.5 – 2.0	21	HMCPE007C0C
	B	2.6 – 3.1	35	
	C	3.7 – 3.9	49	
	D	4.8 – 5.2	63	
	E	5.3 – 5.7	70	
	F	5.8 – 6.1	77	
15	A	3.4 – 4.5	45	HMCPE015E0C
	B	5.7 – 6.8	75	
	C	8.0 – 9.1	105	
	D	10.4 – 11.4	135	
	E	11.5 – 12.6	150	
	F	12.7 – 13.0	165	
30	A	3.9 – 9.1	90	HMCPE030H1C
	B	11.5 – 13.7	150	
	C	16.1 – 18.3	210	
	D	20.7 – 22.9	270	
	E	23.0 – 25.2	300	
	F	25.3 – 26.1	330	
50	A	11.5 – 15.2	150	HMCPE050K2C
	B	19.2 – 22.9	250	
	C	26.9 – 30.6	350	
	D	34.6 – 38.3	450	
	E	38.4 – 42.1	500	
	F	42.2 – 43.5	550	
70	A	16.1 – 30.6	210	HMCPE070M2C
	B	26.9 – 32.2	350	
	C	37.6 – 42.9	490	
	D	48.4 – 53.7	630	
	E	53.8 – 59.1	700	
	F	59.2 – 60.9	770	
100	A	23.0 – 30.6	300	HMCPE100R3C
	B	38.4 – 46.0	500	
	C	53.8 – 61.4	700	
	D	69.2 – 76.8	900	
	E	76.9 – 84.5	1000	
	F	84.6 – 87.0	1100	
100	A	38.4 – 46.0	500	HMCPE100T3C
	B	57.6 – 65.2	750	
	C	76.9 – 84.5	1000	
	D	④	1250	
	E	④	1375	
	F	④	1500	

① UL listed for use with Cutler-Hammer Motor Starters.

② Motor FLA ranges are typical. The corresponding trip setting is at 13 times the minimum FLA value shown. Where a 13 times setting is required for an intermediate FLA value, alternate cam settings and/or MCP ratings should be used.

③ For dc applications, actual trip levels are approximately 40% higher than values shown.

④ Settings above 10xI_n are for special applications. Where the ampere rating of the disconnecting means cannot be less than 115% of the motor full load ampere rating.

Table 64. GJ-Frame — 600 Vac Maximum, 250 Vdc Maximum ⑤

Continuous Amperes	MCP Trip Range (Amperes)	MCP Catalogue Number
250	500 – 1000 625 – 1250 750 – 1500	HMCPJ250D5L HMCPJ250F5L HMCPJ250G5L
	875 – 1750 1000 – 2000 1125 – 2250 1250 – 2500	HMCPJ250J5L HMCPJ250K5L HMCPJ250L5L HMCPJ250W5L

⑤ UL listed for use with Cutler-Hammer Motor Starters.

Table 65. GL-Frame — 600 Vac Maximum, 250 Vdc Maximum ⑥⑦

Continuous Amperes	MCP Trip Range (Amperes)	MCP Catalogue Number
600	1125 – 2250 1500 – 3000 1750 – 3500	HMCPGL600L HMCPGL600N HMCPGL600R
	2000 – 4000 2250 – 4500 2500 – 5000 3000 – 6000	HMCPGL600X HMCPGL600Y HMCPGL600P HMCPGL600M

⑥ Equipped with an electronic trip device.

⑦ UL listed for use with Cutler-Hammer Motor Starters.

Table 66. GN-Frame — 600 Vac Maximum ⑧⑨

Continuous Amperes	Cam Setting	Motor Full Load Current Amperes	MCP Trip Setting	MCP Catalogue Number
800	A	123.1 – 184.5	1600	HMCP800X7W
	B	184.6 – 246.1	2400	
	C	246.2 – 307.6	3200	
	D	307.2 – 369.1	4000	
	E	369.2 – 430.7	4800	
	F	430.8 – 492.2	5600	
	G	492.3 – 553.7	6400	
1200	A	184.6 – 276.8	2400	HMCP12Y8W
	B	276.9 – 369.1	3600	
	C	369.2 – 461.4	4800	
	D	461.5 – 553.7	6000	
	E	553.8 – 646.1	7200	
	F	646.2 – 738.4	8400	
	G	738.5 – 830.7	9600	

⑧ UL listed for use with Cutler-Hammer Motor Starters.

⑨ Equipped with an electronic trip device.

30 mA Ground Fault (Earth Leakage) Modules

**30 mA Ground Fault
(Earth Leakage) Modules**



Clockwise from Left: GJ, GL, GE MCCBs Shown with Ground Fault (Earth Leakage) Modules

Eaton offers a 3- and 4-pole 30 mA ground fault (earth leakage) protection module for GE, GJ and GL breakers. The module does not restrict the use of other breaker accessories. UL-listed modules are available for GJ and GL MCCBs. The IEC-rated GE module is side mounted for circuits up to 125 amperes, while the GJ and GL modules are both bottom mounted for circuits up to 160 and 250 amperes (GJ), or 400 and 630 amperes for the GL.

The module is completely self-contained since the current sensor, relay and power supply are located inside the product. Current pickup settings are selectable from 0.03 – 10 amperes for all IEC-rated modules and GJ UL-listed module, and 0.03 – 30 amperes for the GL UL-listed modules. Time delays are also selectable from Instantaneous – 1.0 seconds for 0.10 ampere settings and above. A current pickup setting of 0.03 amperes defaults to an Instantaneous time setting regardless of the time dial's position. Two alarm contacts come as standard: a 50% pre-trip and a 100% after trip, both based only on earth leakage current levels.

Product Selection

Table 67. GE-Frame Earth Leakage Modules, IEC (Side Mounted, 230 – 415 Vac, 50/60 Hz)

Amperes	Poles	Catalogue Number
125	3	ELESE3125W
125	4	ELESE4125W

Table 68. GJ-Frame Ground Fault Modules, UL-Rated (Bottom Mounted, 120 – 480 Vac, 50/60 Hz)

Amperes	Poles	Catalogue Number
150	3	ELJBN3150W
150	4	ELJBN4150W
250	3	ELJBN3250W
250	4	ELJBN4250W

Table 69. GJ-Frame Earth Leakage Modules, IEC (Bottom Mounted, 230 – 415 Vac, 50/60 Hz)

Amperes	Poles	Catalogue Number
160	3	ELJBE3160W
160	4	ELJBE4160W
250	3	ELJBE3250W
250	4	ELJBE4250W

Table 70. GL-Frame Ground Fault Modules, UL-Rated (Bottom Mounted, 120 – 480 Vac, 50/60 Hz)

Amperes	Poles	Catalogue Number
400	3	ELLBN3400W
400	4	ELLBN4400W
600	3	ELLBN3600W
600	4	ELLBN4600W

Table 71. GL-Frame Earth Leakage Modules, IEC (Bottom Mounted, 230 – 415 Vac, 50/60 Hz)

Amperes	Poles	Catalogue Number
400	3	ELLBE3400W
400	4	ELLBE4400W
630	3	ELLBE3630W
630	4	ELLBE4630W

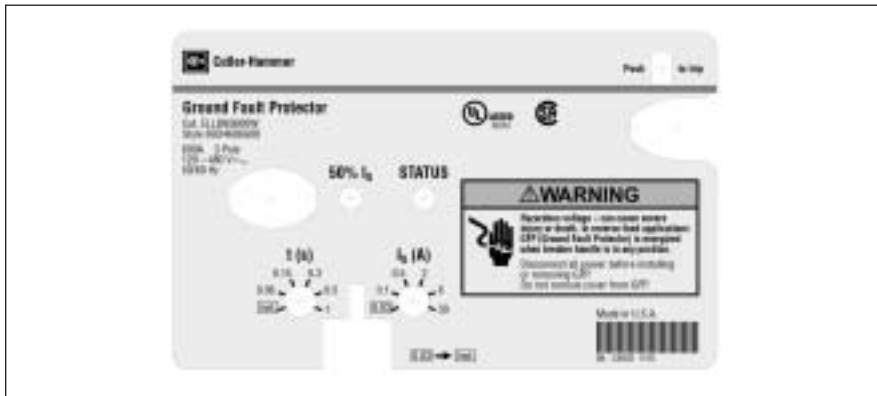

Figure 15. UL-Rated GL-Frame Earth Leakage Module Faceplate

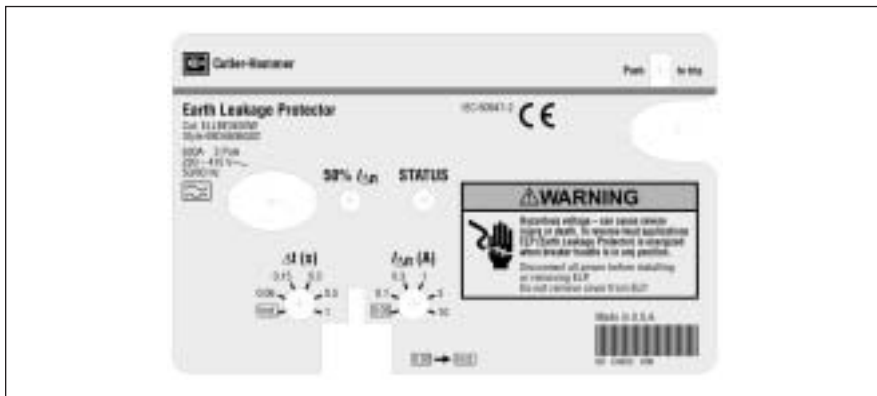

Figure 16. IEC-Rated GL-Frame Earth Leakage Module Faceplate

Special Features and Accessories

Internal Accessories

Alarm Lockout

The alarm switches operate when the circuit breaker is tripped by a short circuit or overcurrent, but also when it is tripped by a shunt trip or undervoltage release.

Auxiliary Switches

Auxiliary switches are used for signaling and control purposes. The various functions of the auxiliary switches (changeover) are shown in Figure 18.

Shunt Trips

The shunt trip is used for remote tripping.

The coil of the shunt trip is rated only for short-time operation.

It is not permissible with the circuit breaker open to apply a continuous opening command to the shunt trip in order to prevent the breaker from closing. This means that interlocking circuits with continuous commands may not be set up with shunt trips.

Undervoltage Releases

The circuit breaker cannot be closed until the undervoltage release is energized. If the release is not energized, the circuit breaker can only perform an idle switching operation.

Frequent idle switching actions should be avoided as they shorten the endurance of the circuit breaker.

Accessory Configurations for GE – GR Circuit Breakers

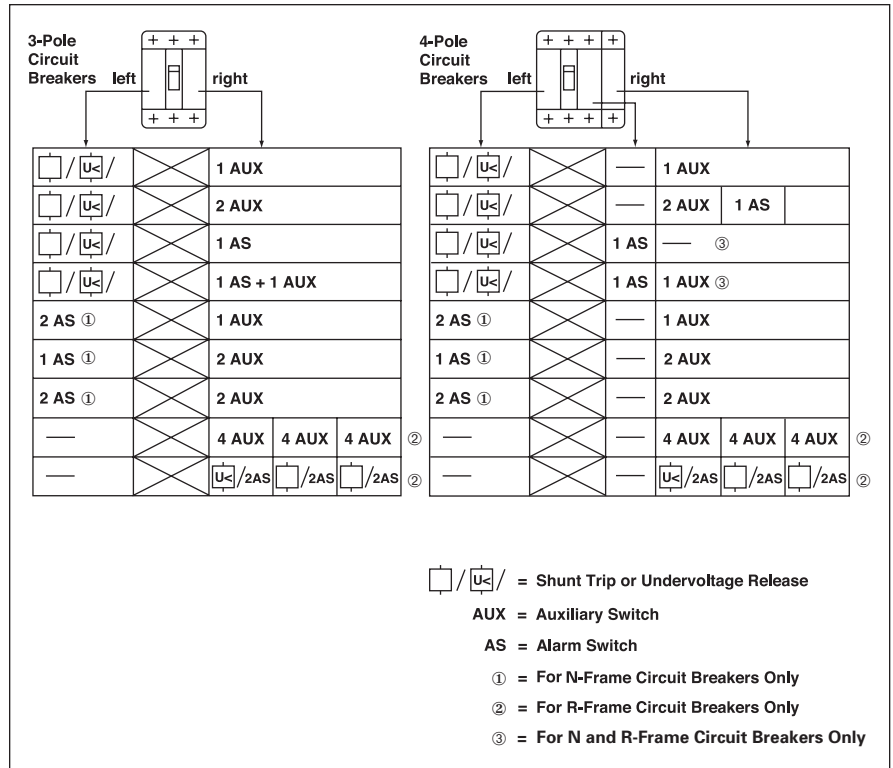

Figure 17. Internal Accessory Configurations

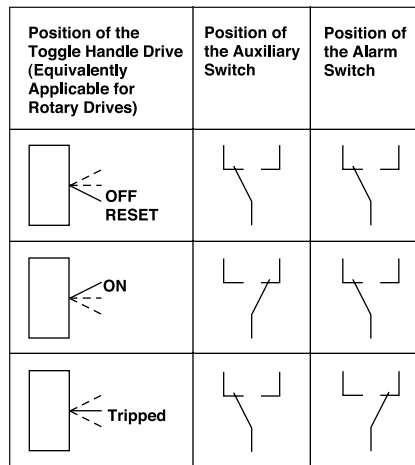

Figure 18. Contact Making by the Auxiliary and Alarm Switches as a Function of the Switching Position of the Circuit Breaker

Special Features and Accessories

Special Calibration

Special non-UL listed calibrations are available for certain ambient temperatures other than 40°C and for frequencies other than 50/60 Hz or dc. Reduced interrupting ratings will apply for 400 Hz applications.

50°C Calibration

Note: Breakers equipped with electronic trip units can operate reliably in ambient temperatures of 50°C. Add suffix "V3" to GN MCCBs to remove standard 40°C labeling.

Add suffix "V" to catalogue number for complete thermal magnetic breaker when ordering listed ampere ratings for breakers to be used in 50°C ambients. 50°C ambient MCCBs are not UL listed.

Contact Eaton for availability.

Moisture-Fungus Treatment

All Eaton Circuit Breaker cases are Moulded from glass-polyester which does not support the growth of fungus. Any parts which are susceptible to the growth of fungus will require special treatment.

Order by description.

Table 72. Calibrations and Treatment

Description	Frame				
	GE	GJ	GL	GN	GR
Special Calibration	✓	✓	✓	✓	✓
Moisture-Fungus Treatment	✓	✓	✓	✓	✓

Table 73. External Accessories and Test Kit

Description	Fit Type	Frame				
		GE	GJ	GL	GN	GR
External Accessories						
Non-Padlockable Handle Block	Field	EFHB	—	—	LKD4	—
Padlockable Handle Block	Field	EFPHB	FJPHB	LBHP	—	—
Padlockable Handle Block Off-Only	Field	EFPHBOFF	FJPHBOFF	LBHPOFF	—	—
Padlockable Handle Lock Hasp	Field	EFPHL	FJPHL	LPHL	PLK5	HLK6
Padlockable Handle Lock Hasp Off-Only	Field	EFPHLOFF	FJPHLOFF	LPHLOFF	—	—
Cylinder Lock	Factory	Order by Description				
Key Interlock Kit ^①	Field	—	KYKFJ	KYKL	KYK4	KYK6
Slide Bar Interlock ^②	Field	EFSBI	FJSBI	SBKL3	SBK5	—
Walking Beam Interlock ^②	Factory	—	FJWBI	WBLL3630	WBL5	WBL6
Electrical Operator	120 Vac	EOPEF240C	EOPFJ240C	EOPLG240C	EOP5T07	EOP6T08
	240 Vac	EOPEF240C	EOPFJ240C	EOPLG240C	EOP5T11	EOP6T11K
	380 Vac	—	—	—	—	—
	24 Vdc	EOPEF24D	EOPFJ24D	EOPLG24D	EOP5T21	EOP6T19K
	48 Vdc	EOPEF48D	EOPFJ48D	EOPLG48D	EOP5T22	EOP6T21K
	125 Vdc	EOPEF240C	EOPFJ240C	EOPLG240C	EOP5T26	—
Plug-In Adapters	3-Pole	PAD3E	PAD3J	PAD3LG	PAD53	—
	4-Pole	PAD4E	PAD4J	PAD4LG	PAD54	—
Rear Connecting Studs	Field	③	③	③	③	—
Test Kit						
Electronic Portable Test Kit ^④	—	⑤	⑤	STK2	STK2	—

① Provision only.





② Requires two breakers.

③ Contact Eaton for catalogue numbers.

④ Digitrip 310 only.

⑤ Catalogue Numbers **MTST120V** (120 Vac) and **MTST230V** (230 Vac).

Table 74. Accessories

Description	Pole Location	Frame			
		GE, GJ & GL	GN	GR	
Field Fit Kit Catalogue Numbers					
Alarm Lockout 	Make/Break	Left	—	A1L5LPK	—
		Right	ALM1M1BEPK ①	A1L5RPK	A1L6RPK
	2 Make/2 Break	Left	—	A2L5LPK	—
		Right	ALM2M2BEPK ②	A2L5RPK	A2L6RPK
Auxiliary Switch 	1A, 1B	Left	—	A1X5LPK	—
		Right	AUX1A1BPK	A1X5RPK	—
	2A, 2B	Left	—	A2X5LPK	—
		Right	AUX2A2BPK	A2X5RPK	A2X6RPK
	3A, 3B	Left	—	A3X5LPK	—
		Right	—	A3X5RPK	—
	4A, 4B	Left	—	—	—
		Right	—	—	A4X6RPK
Auxiliary Switch /Alarm Lockout	Left	—	AA115LPK	—	
	Right	AUXALRMEPK ③	AA115RPK	—	
Shunt Trip — Standard 	120 Vac	Left	SNT120CPK	SNT5LP11K	—
		Right	—	—	SNT6P11K
	240 Vac	Left	SNT120CPK	SNT5LP11K	—
		Right	—	—	SNT6P11K
	24 Vdc	Left	SNT060CPK	SNT5LP03K	—
		Right	—	—	SNT6P03K
	48 Vdc	Left	SNT060CPK	SNT5LP23K	—
		Right	—	—	SNT6P23K
	380 – 600 Vac	Left	SNT480APK	—	—
		Right	—	—	—
220 – 250 Vdc or 380 – 440 Vac	—	—	SNT5LP14K	SNT6P14K	
480 – 600 Vac	—	—	SNT5LP18K	SNT6P18K	
Shunt Trip — Low Energy	Left	—	LST5LPK	—	
	Right	—	—	LST6RPK	
Undervoltage Release Mechanism 	120 Vac	Left	UVR120APK	UVH5LP08K	—
		Right	—	—	UVH6RP08K
	208 – 240 Vac	Left	UVR240APK	UVH5LP11K	—
		Right	—	—	UVH6RP11K
	24 Vdc, Vac	Left	UVR024CPK	UVH5LP21K	—
		Right	—	—	UVH6RP21K
	48 Vdc	Left	UVR048DPK	UVH5LP23K	—
		Right	—	—	UVH6RP23K
	12 Vdc, Vac	Left	UVR012CPK	—	—
		Right	—	—	—
	48 Vac	Left	UVR048APK	UVHLP05K	—
		Right	—	—	UVHRP05K
	120 Vdc	Left	UVR125DPK	UVHLP26K	—
		Right	—	—	UVHRP26K
	220 – 250 Vdc	Left	UVR250DPK	UVHLP28K	—
		Right	—	—	UVHRP28K
	380 – 500 Vac	Left	UVR480APK	UVHLP29K	—
		Right	—	—	UVHRP29K
525 – 600 Vac	Left	UVR600APK	—	—	
	Right	—	—	—	
12 Vdc	Left	—	UVHLP20K	—	
	Right	—	—	UVH6RP20K	
12 Vac	Left	—	UVHLP02K	—	
	Right	—	—	UVH6RP02K	

① Part number for GJ and GL is ALM1M1BJPK.
 ② Part number for GJ and GL is ALM2M2BJPK.
 ③ Part number for GJ and GL is AUXALRMJPK.

Plug-in Blocks and Drawout Cassettes

Plug-in Blocks

Plug-in adapters simplify installation and front removal of circuit breakers. Plug-ins are available for rear connection applications on 3- and 4-pole circuit breakers. Trip on drawout interlock kits are included. Stabs for GE, GJ and GL plug-ins rotate 90° for flexible installation. Use terminal shields for IP30 protection.



GL Breaker with Plug-in Block

Product Selection

Table 75. Plug-in Blocks

Breaker Frame	Poles	Catalogue Number
---------------	-------	------------------

GE-, GJ- and GL-Frame Plug-in Blocks

GE	3	PAD3E
GE	4	PAD4E
GJ	3	PAD3J
GJ	4	PAD4J
GL	3	PAD3L
GL	4	PAD4L

Trip-on Drawout Interlock Kit ①

GE	3, 4	PIILEG
GJ	3, 4	PIILJG
GL	3, 4	PIILLG

Terminal Shields IP30

GE	3	EFTS3K
GE	4	EFTS4K
GJ	3	FJTS3K
GJ	4	FJTS4K
GL	3	LTS3K
GL	4	LTS4K

① Included with plug-in block. Trips the breaker when breaker is removed from plug-in block.

Drawout Cassette



Drawout Cassette

The Drawout Cassette is currently for use with the standard 3-pole 65 and 100 kA/480 Vac, 1600 ampere and 2000 ampere GR circuit breakers only. It consists of two separate components: the movable mechanism which is factory mounted to the circuit breaker frame (shown in photo above) and the stationary mechanism which is housed in the cassette and shipped separately.

The drawout mechanism has four positions.

- Connected — The breaker is fully connected to the primary stabs and secondary contacts.
- Test — The breaker is not connected to the primary stab but is connected to the secondary contacts.
- Disconnected — Both the primary stabs and the secondary contacts are disconnected.
- Withdraw — The breaker can be removed from the cassette.

Table 76. GR Drawout Cassette

Description	Catalogue Number
65 kA/480 Vac Version	
Movable Mechanism	RD20DOM ②
Stationary Mechanism	RD20DOS (without shutters) RD20DOSS (with shutters)
100 kA/480 Vac Version	
Movable Mechanism	RD20DOM ②
Stationary Mechanism	RD20DOS (without shutters) RD20DOSS (with shutters)

② List price included in price of the stationary mechanism.

Movable mechanism must be ordered with GR circuit breaker and is shipped mounted to circuit breaker frame. Stationary mechanism is ordered separately.

All internal accessories must be factory installed for use with drawout.

Handle Mechanisms Overview

Handle mechanisms are used to operate Moulded case circuit breakers, Moulded case switches and motor circuit protectors. They are available in three basic configurations — Flange Mounted, Through-the-Door and Direct (Close-Coupled) — providing safe, dependable operation and ease of installation.

Flange Mounted

- Flex Shaft

Through-the-Door

- Universal Rotary

Direct (Close Coupled)

- Universal Direct
- Euro IEC

Handle mechanisms are typically used on enclosed circuit breakers, control panels and motor control centers in many different applications. Eaton Electrical has a handle mechanism for virtually any need.

Flange Mounted Handle Mechanisms

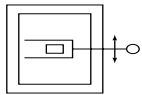

The Flex Shaft™

Flange Mounted handle mechanisms mount on the flange of an enclosure door. The Flex Shaft is an extra heavy-duty mechanism that includes a flexible shaft in various lengths, 0.9 m (3 feet) through 3 m (10 feet) for use with various size enclosures.

The Flex Shaft handle will accept up to three padlock shackles, each with a maximum diameter of 9.5 mm (3/8 inch). Can be used with NEMA 12 fabricated enclosures. An optional handle is available for Flex Shaft that is suitable for use with NEMA 4 environments.

Flex Shaft comes preset from the factory, requiring only minor field adjustments on installation, which takes about 10 minutes — a significant time savings compared to installation of other types of flange handle mechanisms. The Flex Shaft mechanism also takes up less interior enclosure space than competitive designs and the handle fits standard flange cutouts. Flex Shaft handle can be remotely mounted from breaker, where an operator can use it by “funneling” the cable through conduit.

Flex Shaft is UL listed under File E64893 and meets CSA requirements.

Flex Shaft Ordering Information

Table 77. Flex Shaft Ordering Information

Breaker Frame	Flexible Shaft Length in Meters (Feet)							
	Catalogue Number							
	0.9 (3)	1.2 (4)	1.3 (5)	1.8 (6)	2.1 (7)	2.4 (8)	2.7 (9)	3.1 (10)
GE	EHMFS03	EHMFS04	EHMFS05	EHMFS06	EHMFS07	EHMFS08	EHMFS09	EHMFS10
GJ	JHMFS03	JHMFS04	JHMFS05	JHMFS06	JHMFS07	JHMFS08	JHMFS09	JHMFS10
GL	—	LHMFS04	—	—	LHMFS07	—	—	LHMFS10
GN	N/A	F5S04CI	F5S05CI	F5S06CI	N/A	N/A	N/A	F5S10CI
GR	N/A	F6S04	F6S05	F6S06	N/A	N/A	N/A	N/A

Note: Add Suffix L to the complete Catalogue Number for 152.4 mm (6-inch) handle.

Flex Shaft Accessories (E- through R-Frame)

Table 78. Standard Door Hardware (Required Adapter Kit)

Latch	Panel Height in mm (Inches)	Catalogue Number
2 Point	Up to 762.0 (30.00)	DH1R
2 Point	Up to 1016.0 (40.00)	DH2R
3 Point	Over 1016.0 (40.00)	DH3R

Table 79. Door Hardware Adapter Kit (Required on Standard Door Hardware)

Description	Catalogue Number
Door Hardware Adapter Kit	AMTDHA

Table 80. NEMA 12 Safety Door Hardware for Flex Shaft ①

Handle Length in mm (Inches)	Catalogue Number ②
101.6 (4.00)	C361KJ4
152.4 (6.00)	C361KJ6
Roller Latch ③	C361KR

① Customer: Consult with box manufacturer for correct door hardware and any adapters required for assembly.

② The 6.35 x 12.7 mm (1/4-inch x 1/2-inch) standard mill rectangular locking bar is not supplied with these kits.

③ Third roller latch for use with 101.6 or 152.4 mm (4- or 6-inch) handle when 3 point latching is required.

Table 81. NEMA — IP Crossover

NEMA Type	IP Type
1	IP20
3R	IP55
12	IP54
4/4X	IP66

Handle Mechanisms

Through-the-Door Handle Mechanisms

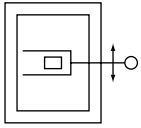

Universal Rotary

The Eaton Universal Rotary is suitable for use with NEMA 12 enclosure types. An optional NEMA 4/4X handle mechanism is also available. All rotary handle mechanisms include a handle "Lock Off," to prevent turning the breaker ON while in the OFF position. All Rotary handles indicate ON/OFF/Tripped/Reset positions, however, Universal Rotary has the added feature of international markings for ON (I) and OFF (O). The Universal Rotary is made of Moulded material.

The Universal Rotary mechanisms for GE, GJ and GL MCCBs can be operated by hand with the door open or "locked off" to prevent operation with the door open.

For the GN-Frame MCCBs, a Eaton Rotary with a metal handle (**Table 83**) is also available.

Table 82. Universal Rotary Ordering Information

Shaft Length in mm (Inches)	Handle Colour	Complete Catalogue Number ①②
-----------------------------	---------------	---------------------------------

GE-Frame

152.4 (6.00)	Black	EHMVD06B
304.8 (12.00)	Black	EHMVD12B
609.6 (24.00)	Black	EHMVD24B
152.4 (6.00)	Red	EHMVD06R
304.8 (12.00)	Red	EHMVD12R
609.6 (24.00)	Red	EHMVD24R

GJ-Frame

152.4 (6.00)	Black	FJHMVD06B
304.8 (12.00)	Black	FJHMVD12B
609.6 (24.00)	Black	FJHMVD24B
152.4 (6.00)	Red	FJHMVD06R
304.8 (12.00)	Red	FJHMVD12R
609.6 (24.00)	Red	FJHMVD24R

GL-Frame

152.4 (6.00)	Black	KLHMVD06B
304.8 (12.00)	Black	KLHMVD12B
609.6 (24.00)	Black	KLHMVD24B
152.4 (6.00)	Red	KLHMVD06R
304.8 (12.00)	Red	KLHMVD12R
609.6 (24.00)	Red	KLHMVD24R

GN-Frame

152.4 (6.00)	Black	HMVD5B
--------------	-------	---------------

GR-Frame

235.0 (9.00)	Black	HMVD6B
--------------	-------	---------------

① Complete catalogue number includes handle, mechanism, shaft and mounting hardware.

② Add suffix "X" for NEMA 4/4X.

Table 83. Eaton Rotary Ordering Information — GN-Frame

Shaft Length in mm (Inches)	Handle Colour	Complete Catalogue Number ③	
		NEMA 1, 3R, 12	NEMA 4/4X
152.4 (6.00)	Black	WHM5R06	WHM5R06X
304.8 (12.00)	Black	WHM5R12	WHM5R12X
406.4 (16.00)	Black	WHM5R16	WHM5R16X
609.6 (24.00)	Black	WHM5R24	WHM5R24X

③ Complete catalogue number includes handle, mechanism, shaft and mounting hardware.

Handle Mechanisms

**Direct (Close-Coupled)
Handle Mechanisms**



Universal Direct (GE – GL)

Direct (Close-Coupled) Handle Mechanisms mount directly to the circuit breaker. They are used in shallow enclosures where the standard variable depth Through-the-Door type mechanism is not practical or cannot be used. They are typically for applications where high volume, standardized enclosures are being fabricated.

The Universal Direct handle mechanism is designed exclusively for the new Eaton GE, GJ and GL circuit breakers. It is available as standard with a door interlock to prevent opening the enclosure while the circuit breaker is in the ON position. It is also available without a door interlock.

The Universal Direct handle mechanism is UL 489 listed, IEC 60947-1/2 and meets CSA requirements.

The Euro IEC Direct handle mechanism is designed for GN and GR MCCBs. The Euro IEC Direct handle mechanism is 60947-112.

Table 84. Universal Direct Ordering Information

Frame	White Handle Colour		Red Handle Colour
	with Interlock	without Interlock	without Interlock
	Catalogue Number		
GE	EHMCCBI	EHMCCB	EHMCCR
GJ	JHMCCBI	JHMCCB	JHMCCR
GL	LHMCCBI	LHMCCB	LHMCCR

Table 85. Euro IEC Direct Ordering Information

Frame	Catalogue Number
	Black Handle
GN	HMVD5B
GR	HMVD6B

Time Current Curves

Tripping Characteristics

The operating values specified for the inverse time overcurrent releases (thermal overload releases, "a" releases) are mean values of the scatter bands of all setting ranges from the cold state and with uniform current loading of the conducting paths.

The tripping characteristics of the instantaneous (electromagnetic) short circuit releases ("n" releases) are based on the rated phase current I_N which in the case of circuit breakers with adjustable thermal overload releases is also the upper value of the setting range. With a lower setting current, a correspondingly higher multiple is obtained for the operating current of the "n" release.

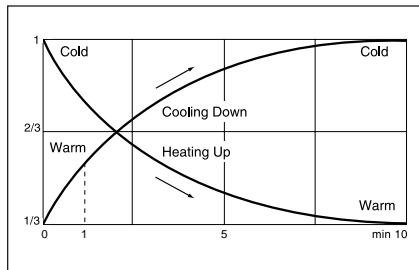

Figure 19. Tripping Time Characteristics (Thermal Memory)

Type GE

Tripping characteristics of GE circuit breakers for plant protection, "n" release fixed setting = 400 – 600 for breaker 15 – 45 A; over 50 A = $10 \times I_N$.

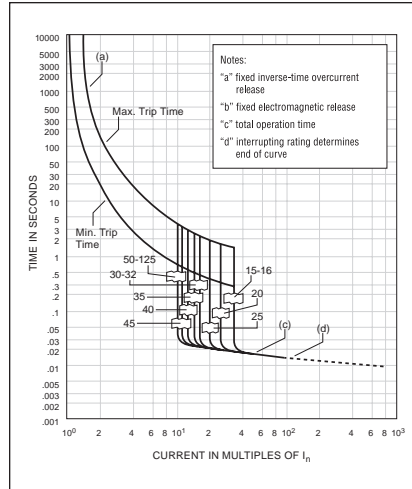

Figure 20. GE Time Current Curve

Type GJ

Tripping characteristics of GJ circuit breakers for plant protection, "n" release adjustable.

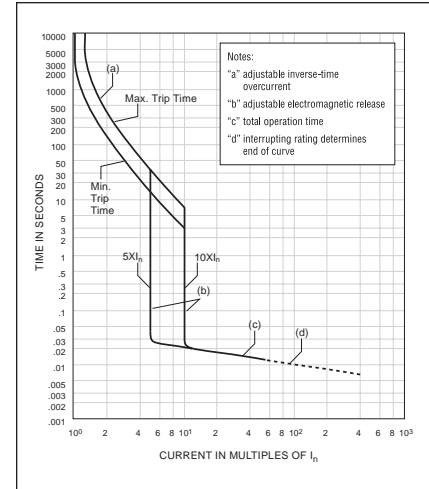

Figure 21. GJ Time Current Curve for Thermal Magnetic Trip Units

Type GL

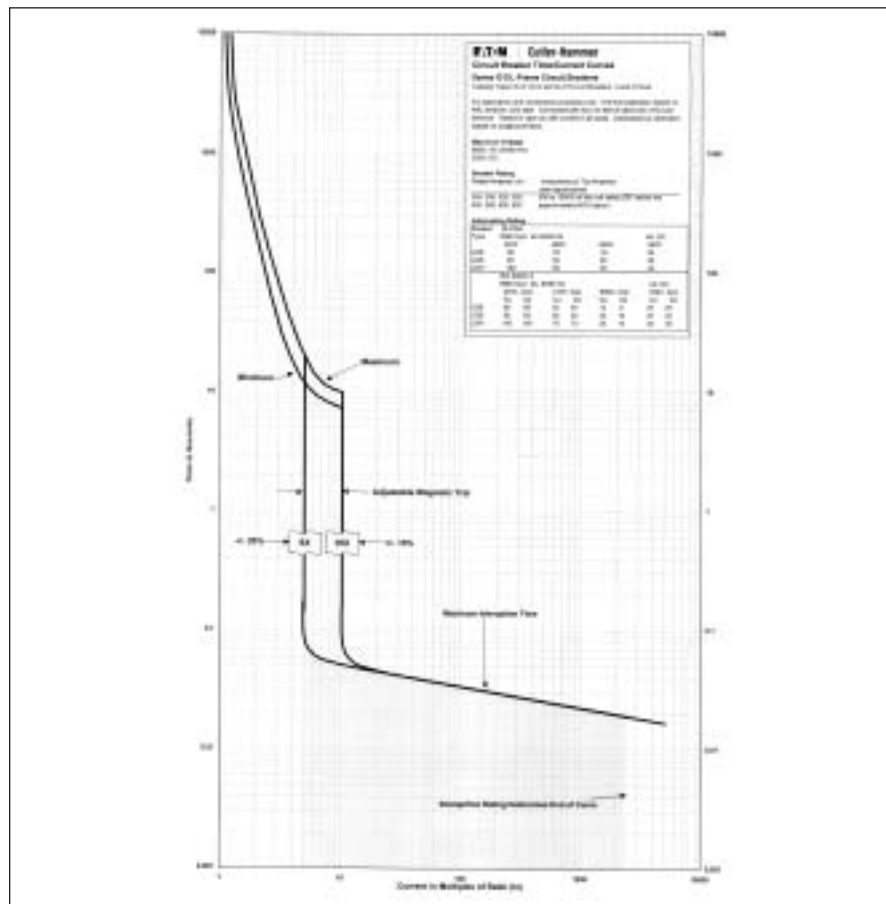

Figure 22. GL Time Current Curve for Thermal Magnetic Trip Units

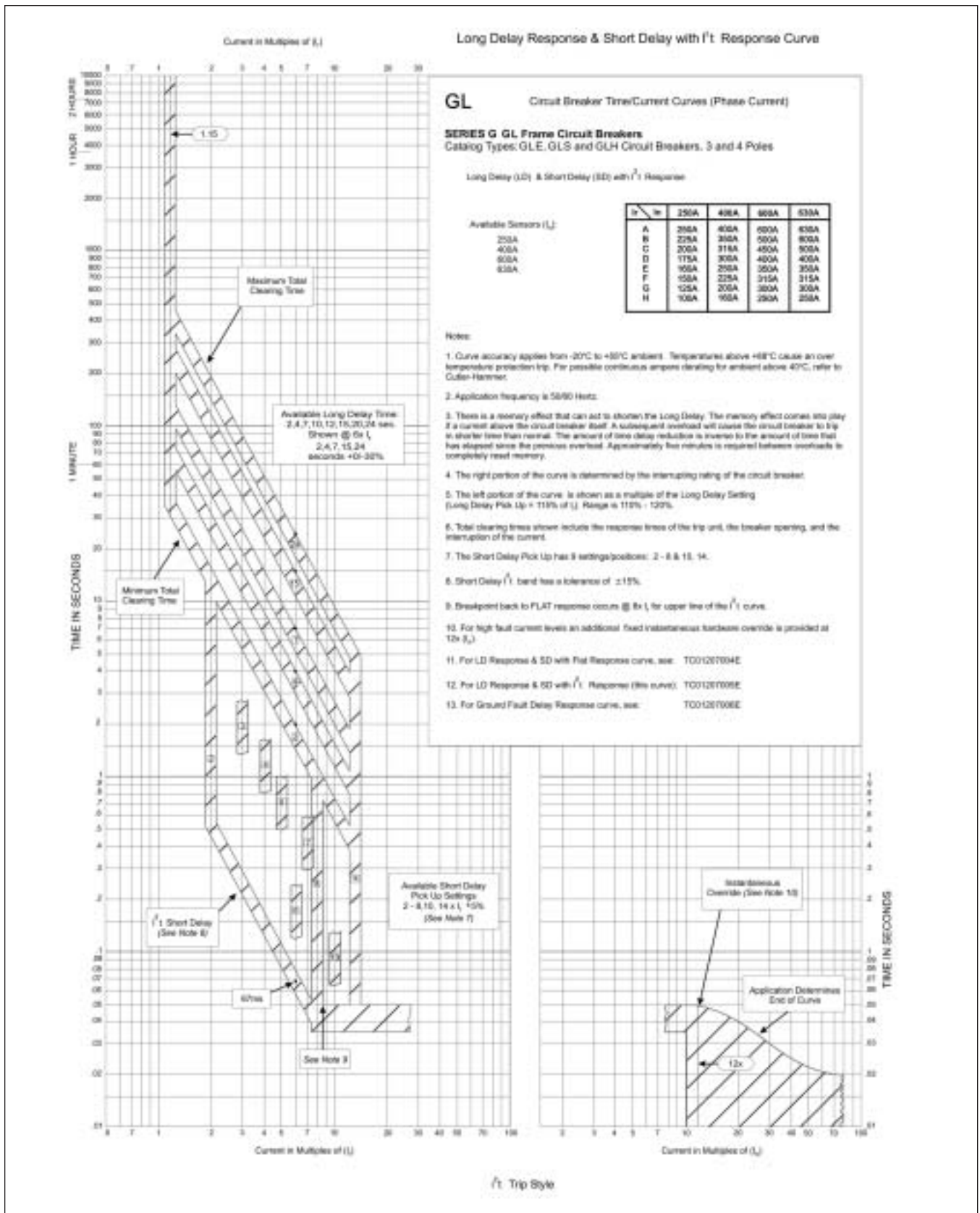

Figure 23. GL Electronic Trip Unit Long Delay Response and Short Delay with I^2t Response Curve

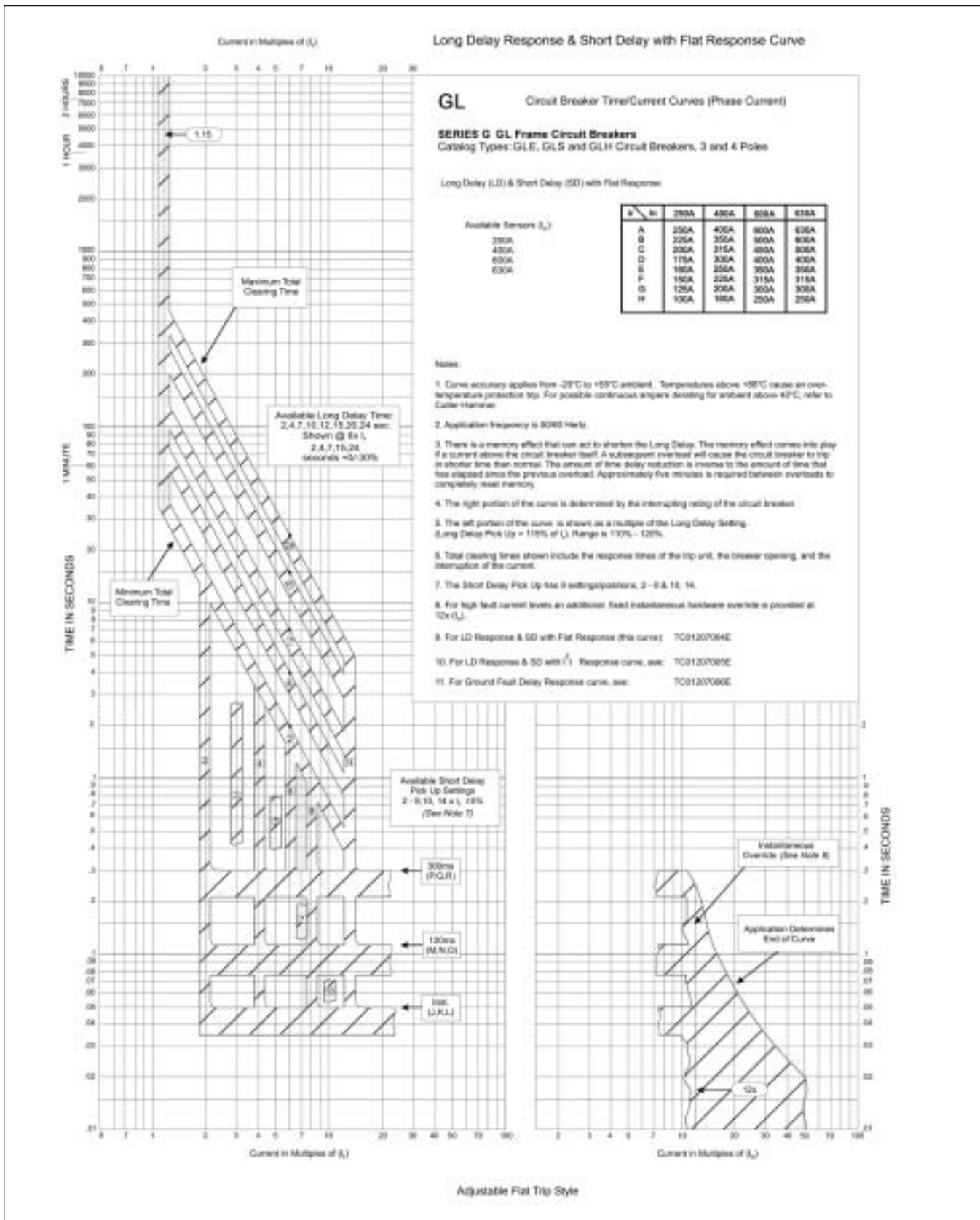

Figure 24. GL Electronic Trip Unit Long Delay Response and Short Delay with Flat Response Curve

September 2005
Vol. 1, Ref. No. [047]

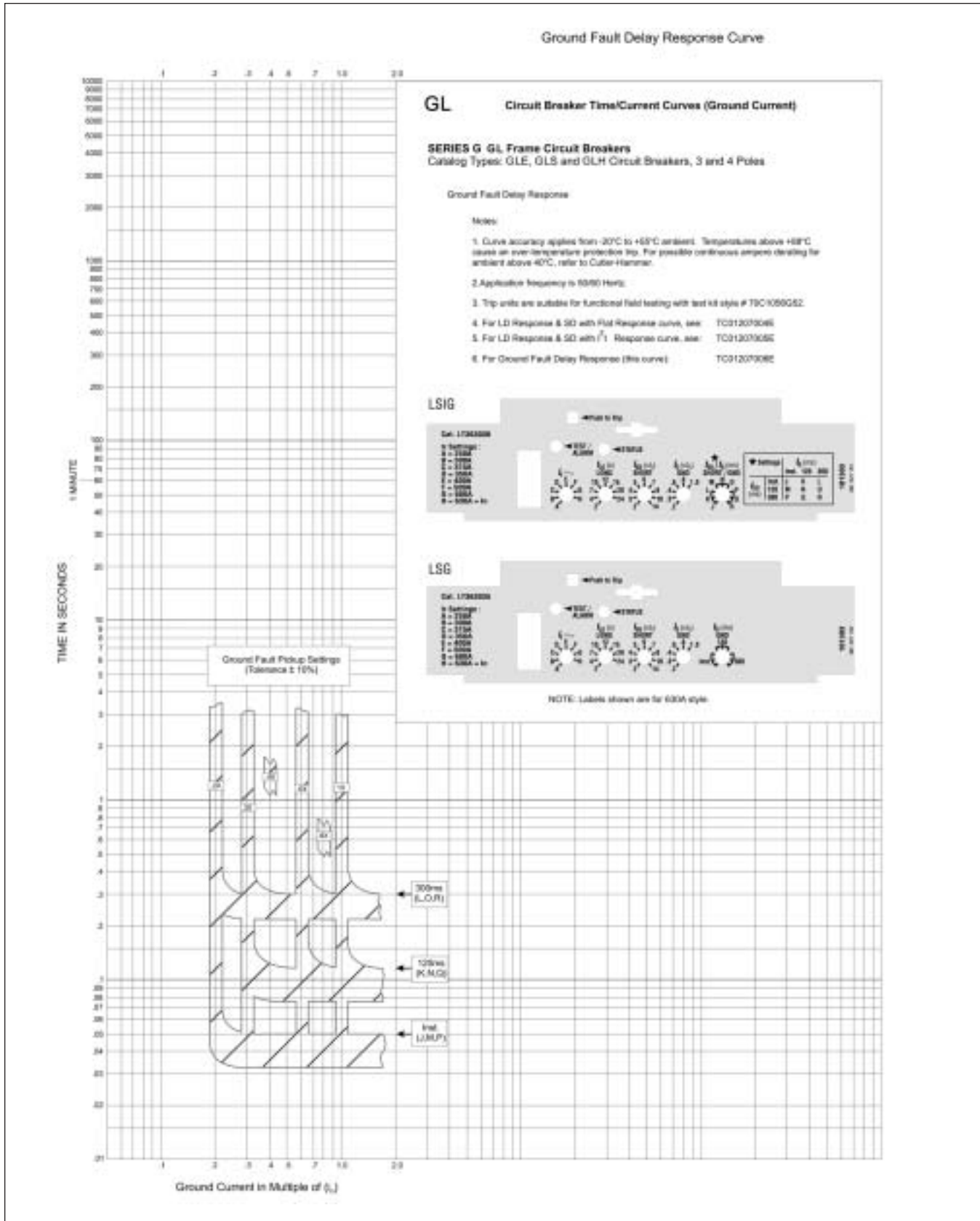

Figure 25. GL Electronic Trip Unit Ground Fault Delay Response Curve

Type GN

Tripping characteristics of GN circuit breakers with solid-state overcurrent release.

Working Temperature Range

The tolerance bands shown are applicable to an ambient temperature range of -5 to +60°C at the circuit breaker.

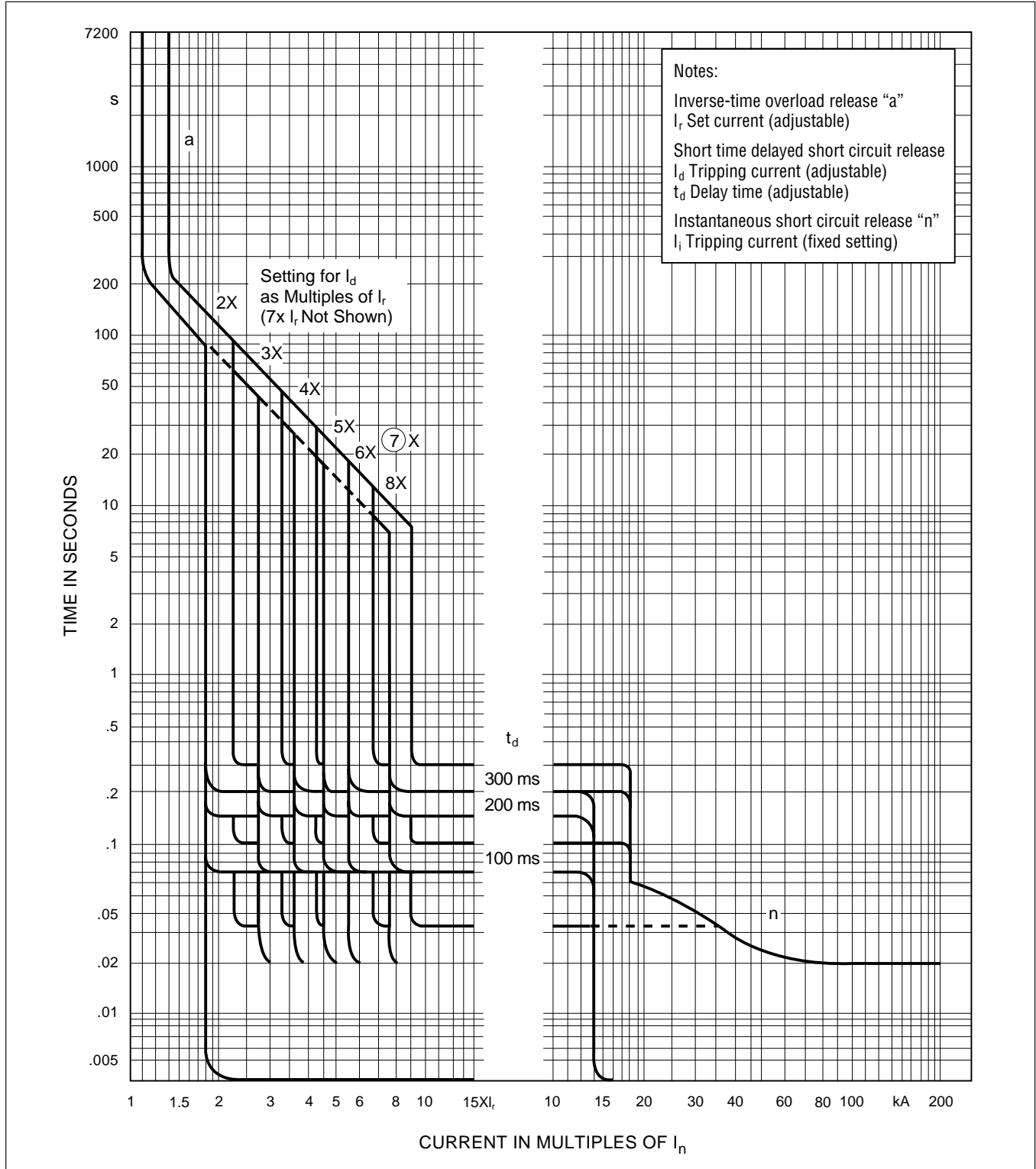

Figure 26. GN Time Current Curve for Digitrip 310 Trip Unit

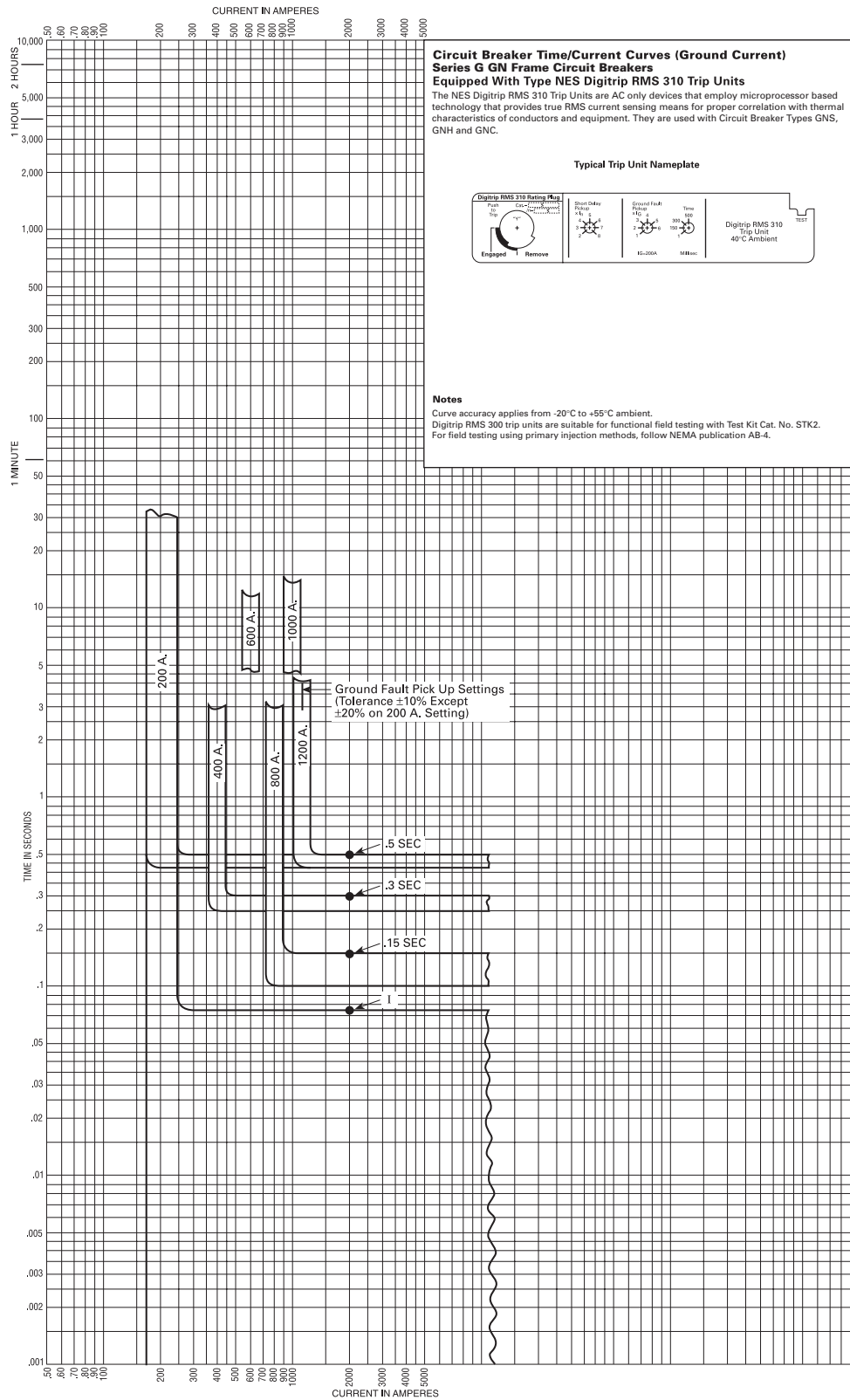

Figure 27. GN Ground Fault Delay Response Curve for Digitrip 310 Trip Unit

Type GR

Tripping characteristics of GR circuit breakers with solid-state overcurrent release.

Working Temperature Range

The tolerance bands shown are applicable to an ambient temperature range of -5 to +60°C at the circuit breaker.

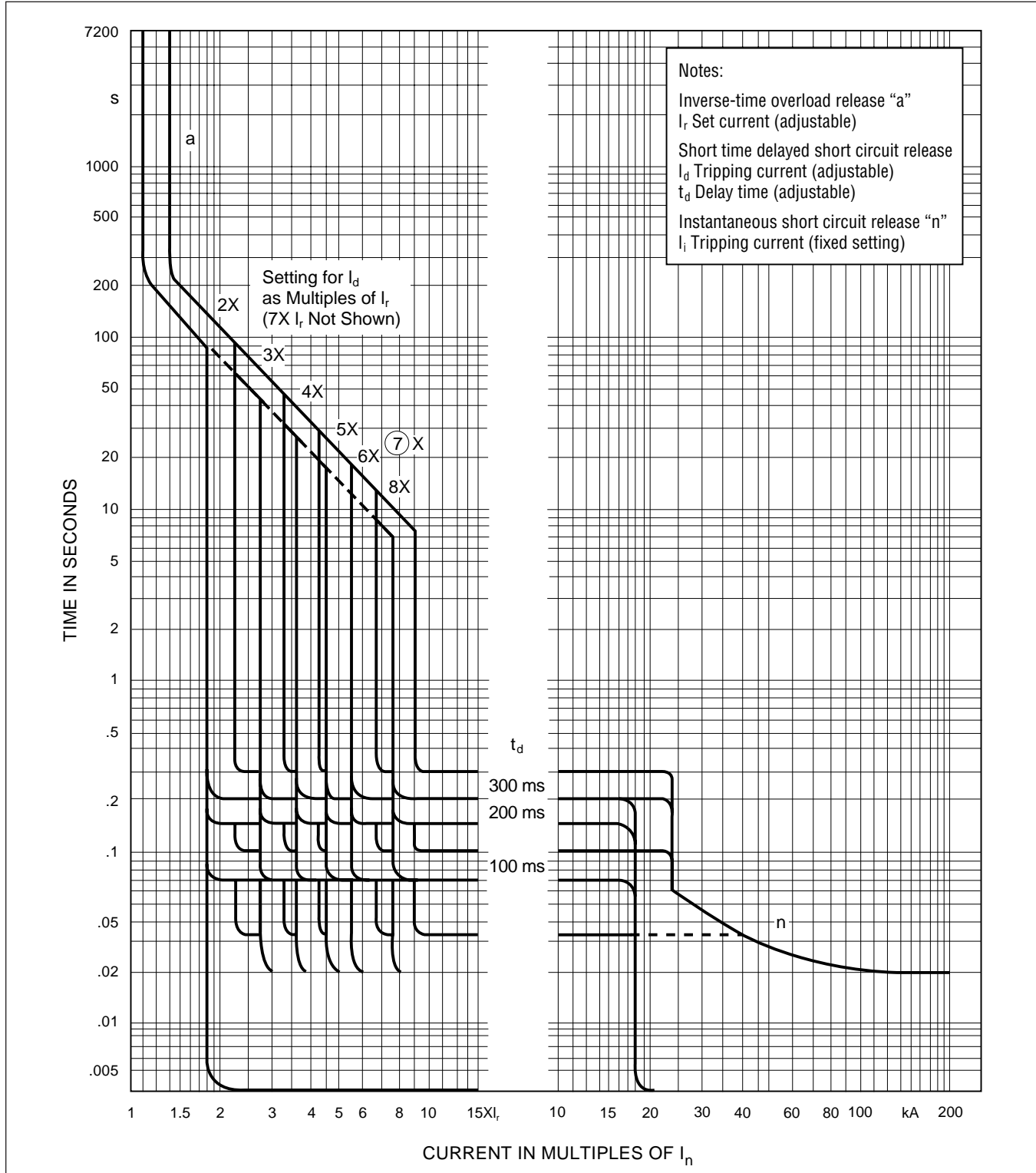

Figure 28. GR Time Current Curve for Digitrip 310 Trip Unit

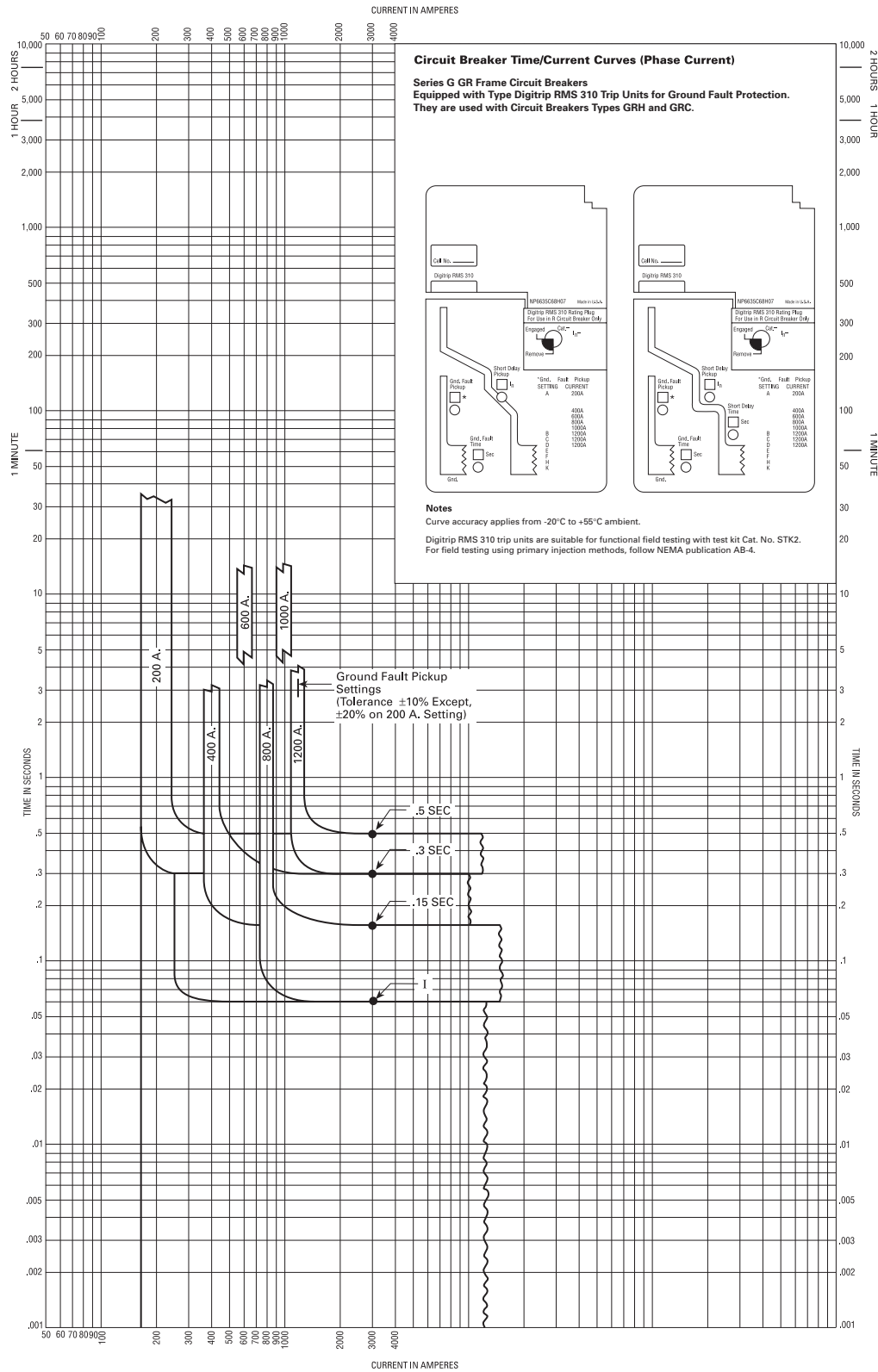

Figure 29. GR Ground Fault Delay Response Curve for Digitrip 310 Trip Unit

Frame Sizes GE through GR

Current Limiting Curves

Current Limiting Characteristics and Maximum I²t Values

Type GE/GJ/GL

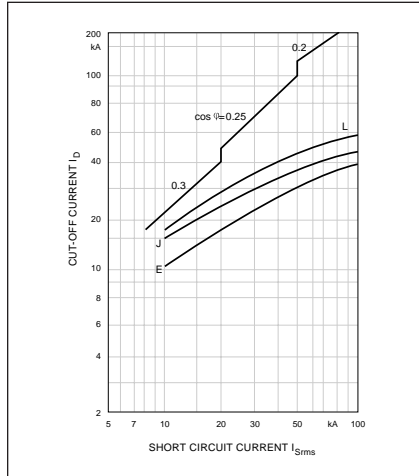

Figure 30. Current Limiting Characteristics for GE to GL, 50/60 Hz 380/415/480 Vac

Type GE/GJ/GL

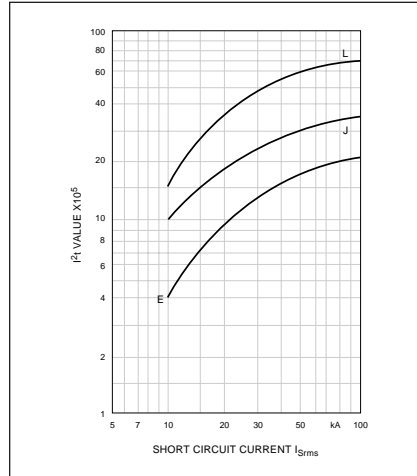

Figure 32. Maximum I²t Values for GE to GL, 50/60 Hz 380/415/480 Vac

Type GN/GR

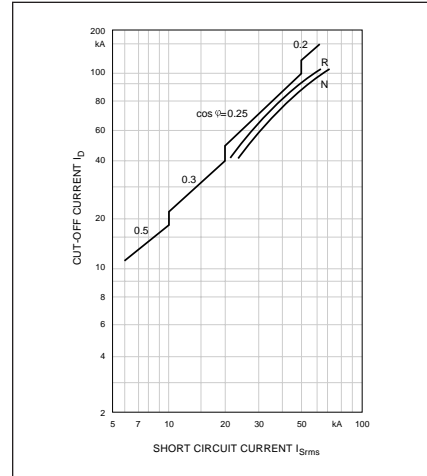

Figure 34. Current Limiting Characteristics I_b for GN to GR, 50/60 Hz 380/415/480 Vac

Type GE/GJ/GL

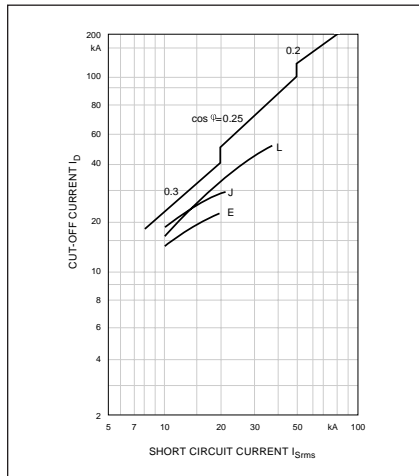

Figure 31. Current Limiting Characteristics for GE to GL, 50/60 Hz 600/660/690 Vac

Type GE/GJ/GL

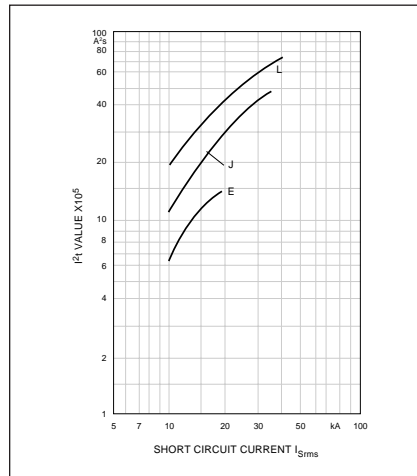

Figure 33. Maximum I²t Values for GE to GL, 50/60 Hz 600/660/690 Vac

Type GN/GR

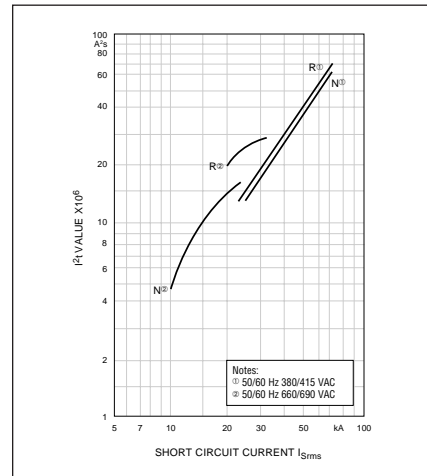

Figure 35. Maximum I²t Values for GN to GR, 50/60 Hz 600/660/690 Vac

Dimensions

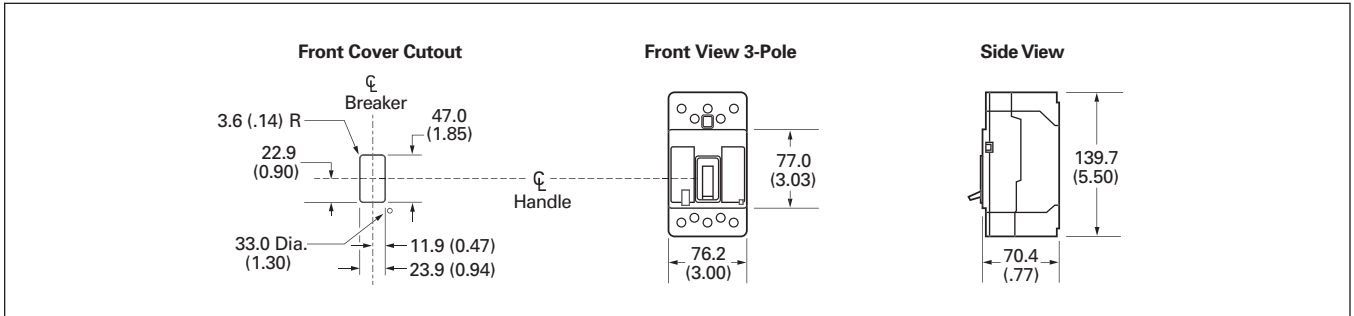

Figure 36. GE-Frame — Dimensions in mm (Inches)

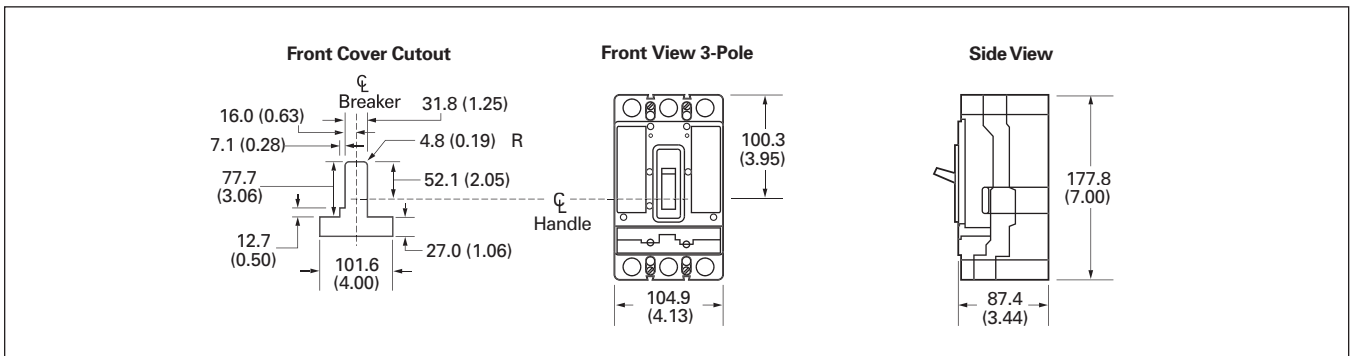

Figure 37. GJ-Frame — Dimensions in mm (Inches)

Frame Sizes GL through GR

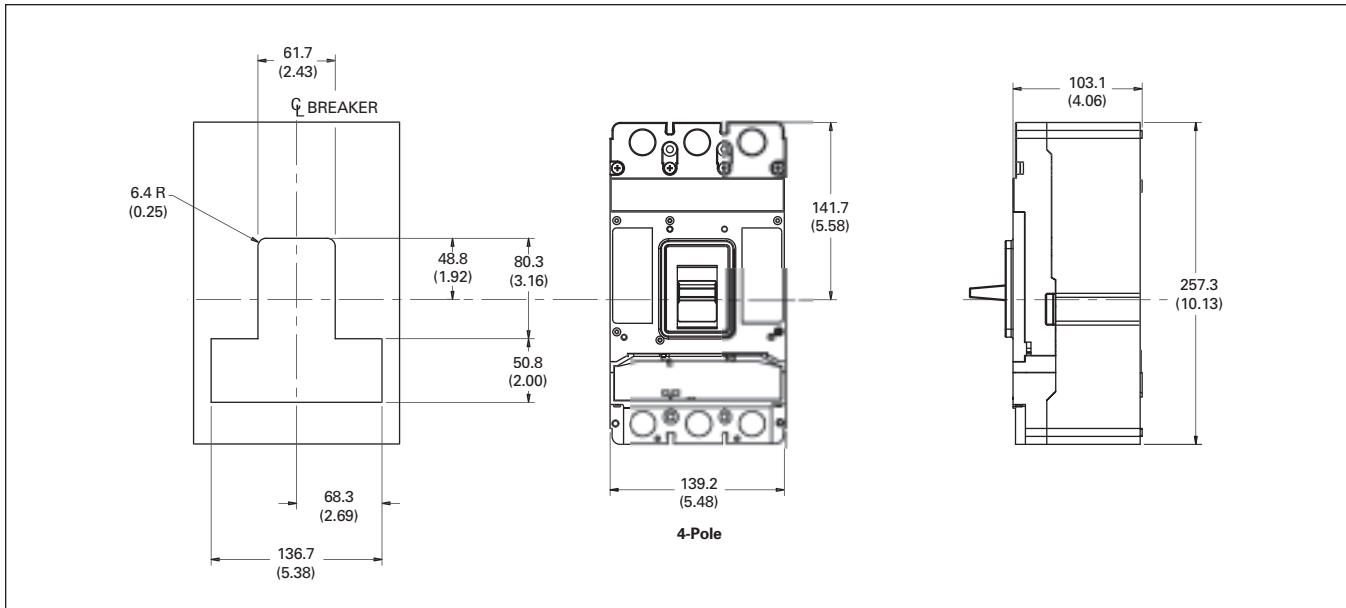

Figure 38. GL-Frame — Dimensions in mm (Inches)

Note: TA63IL, T63IL, T632L, TA632L terminals add 30.2 mm (1.19 inches) to line or load side of GL. LTS3K or LTS4K terminal covers add 54.1 mm (2.13 inches) to line or load side of GL.

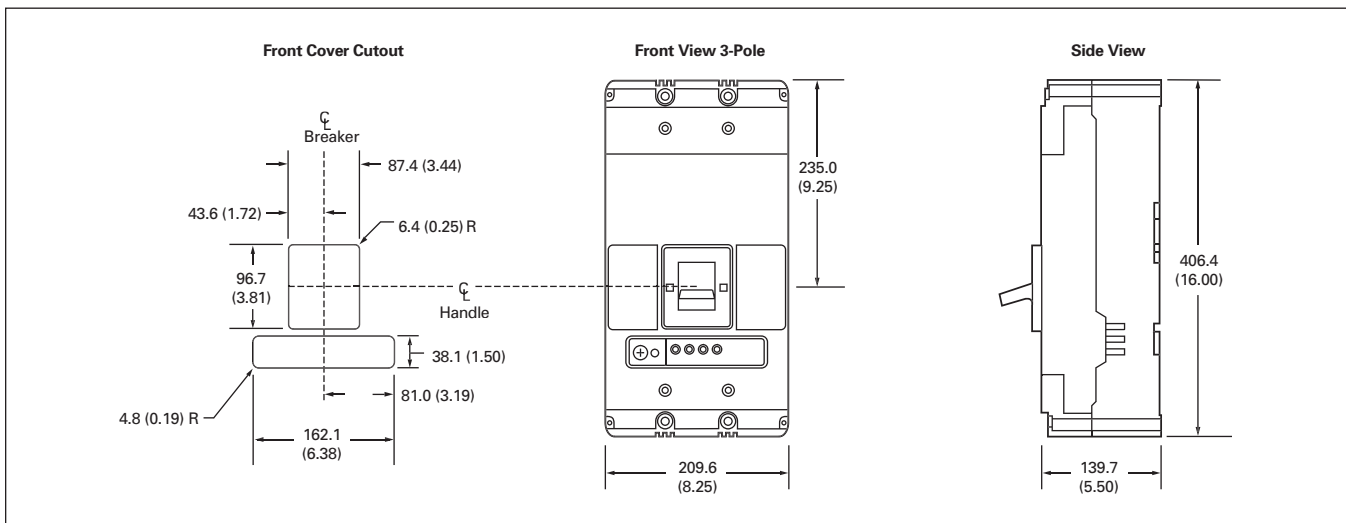

Figure 39. GN-Frame — Dimensions in mm (Inches)

September 2005
Vol. 1, Ref. No. [055]

Frame Size GR

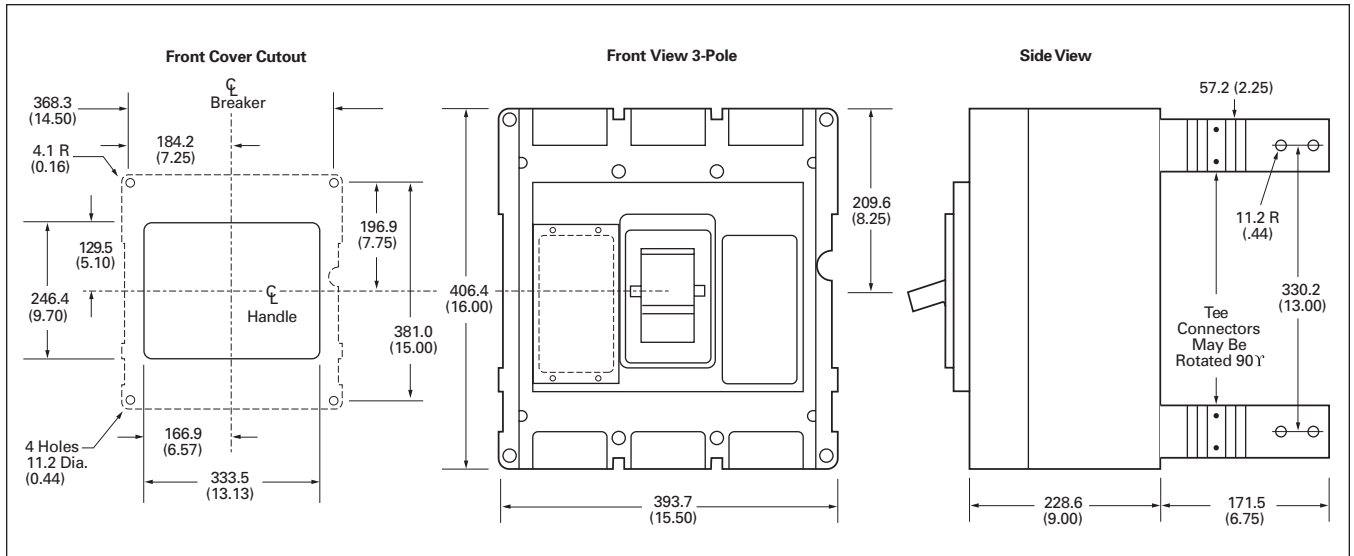

Figure 40. GR-Frame — Dimensions in mm (Inches)

Notes

Eaton's electrical business is a global leader in electrical control, power distribution, and industrial automation products and services. Through advanced product development, world-class manufacturing methods, and global engineering services and support, Eaton's electrical business provides customer-driven solutions under brand names such as Cutler-Hammer®, Powerware®, Durant®, Heinemann®, Holec® and MEM®, which globally serve the changing needs of the industrial, utility, light commercial, residential, and OEM markets. For more information, visit www.EatonElectrical.com.

Eaton Corporation is a diversified industrial manufacturer with 2004 sales of \$9.8 billion. Eaton is a global leader in electrical systems and components for power quality, distribution and control; fluid power systems and services for industrial, mobile and aircraft equipment; intelligent truck drivetrain systems for safety and fuel economy; and automotive engine air management systems, powertrain solutions and specialty controls for performance, fuel economy and safety. Eaton has 57,000 employees and sells products to customers in more than 125 countries. For more information, visit www.eaton.com.

Eaton Electrical Inc.
1000 Cherrington Parkway
Moon Township, PA 15108
United States

For more information or to locate
regional product support, please visit
us at www.EatonElectrical.com

