

EVLP Low Profile Hazard•Gard® (H.I.D.) Luminaires

Medium and Mogul Base

Cl. I, Div. 1, Groups B (GB suffix), C, D
 Cl. I, Zone 1, Groups IIB + H₂ (with suffix – GB), IIB, IIA
 Cl. II, Div. 1, Groups E, F, G; Class III

Marine & Wet Locations
 3, 3R, 4, 4X; IP66

4L

Applications:

- Eaton's Crouse-Hinds Low Profile Hazard•Gard® luminaires are used in:
- Areas where flammable or explosive vapors or gases are present
 - Hazardous areas, both indoors and outdoors, where long life and low maintenance costs are desired
 - Petroleum refineries, chemical, petrochemical and pharmaceutical plants, oil terminals, gas plants and other heavy process industry facilities
 - Waste treatment facilities
 - Drilling platforms and other coastal and offshore hazardous areas



Features and Benefits:

- Small, compact size is perfect where low mounting restrictions are a concern.
- Two start Acme threaded construction allows for easier assembly, installation and maintenance.
- Lightweight copper-free aluminum housing with powdered epoxy finish for superior corrosion resistance.
- All exterior hardware is corrosion-resistant stainless steel.
- Four mounting arrangements: pendant, ceiling, wall bracket and stanchion suit any lighting layout.
- Wide range of light sources and wattages to meet specific lighting needs.
- Marine and NEMA 4X construction suitable for outdoor, hose down, marine and corrosive environments.
- Integral ballast for lowest installed cost.
- High power factor (90%+) ballasts allows more fixtures per circuit.
- Uses same mounting modules as the standard Hazard•Gard® for easy retrofitting when the EVLP is the preferred choice.
- Internally fluted glass globe reduces glare and distributes light evenly – ideal for adverse environments typical of industrial facilities.
- Krydon® construction dome and angle reflectors – won't rust, corrode, dent, chip or peel
- Now available in components – luminaire body, mounting module, guard, reflectors – allowing for easy stocking for Quick Ship requirements.

Certifications and Compliances:

- NEC and CEC:
 - Class I, Division 1, Groups B (with suffix GB), C, D – All Wattages
 - Class I, Zone 1, Groups IIB + H₂ (with suffix GB), IIB, IIA – All Wattages
 - Class II and Class III
- UL Standards:
 - 844, Hazardous (Classified) Locations
 - 1598 Luminaires
 - 1598A Marine Locations
- CSA Standards
 - C22.2 No. 137

Options:

Description	Suffix
• Group B suitability	GB
• Ballast-Gard™ (HPS only)	BG
• Instant restrike (Mogul Base only)	IR
70–150W LX HPS	
• Cannot use with BG Option	
• Fused (not suitable for marine applications).....	S658*
• Quartz auxiliary lighting (Mogul Base only)	QTZ
• Cannot use with IR option	
• Uses 100W single ended double contract lamp	
• Quartz lamp not included	
• Factory assembled with lamps	FA

*When ordering fuses for luminaires, option S658, you must specify the operating voltage. S658 cannot be ordered with /MT in the catalog number.

Accessories:

Description	Cat. #
Dome reflector	RD739
Angle reflector	RA739

Standard Materials:

- Mounting modules, cover, ballast housing, globe holder – copper-free aluminum
- Globe – heat and impact resistant glass
- Exterior hardware – stainless steel
- Reflectors (dome & angle) – Krydon® fiberglass-reinforced polyester

Standard Finishes:

- Copper-free aluminum – Corro-free™ powdered epoxy
- Krydon – white
- Stainless steel guard

Ratings (Electrical/Size):

Sources/Wattage:

- Medium Base 70–150W HPS, 70–175W MH
- Mogul Base 70–150W HPS, 70–250W MH

Voltages:

- Medium & Mogul H.I.D.
 - 120V 60Hz
 - Multi-tap (120, 208, 240, 277V 60Hz)
 - Tri-tap (120, 277, 347V 60Hz)
 - 480V 60Hz
 - Other voltages – consult Eaton's Crouse-Hinds

Conduit Entries:

- ¾", 1" NPT – pendant, wall bracket, ceiling
- 1¼" NPT – stanchion

4L

4L EVLP Low Profile Hazard•Gard®

Medium Base

Cl. I, Div. 1, Groups B (GB suffix), C, D
 Cl. I, Zone 1, Groups IIB + H₂ (with GB suffix), IIB, IIA
 Cl. II, Div. 1, Groups E, F, G; Class III

Marine & Wet Locations
 3, 3R, 4, 4X; IP66

Ordering Information:

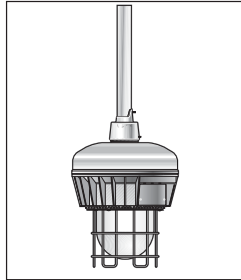

Pendant Mount

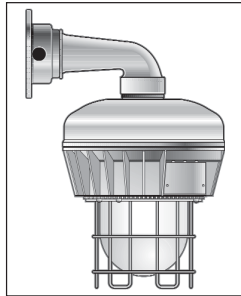

†Wall Bracket Mount

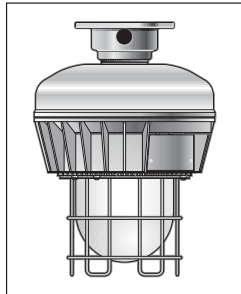

†Ceiling Mount

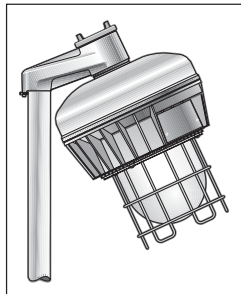

Stanchion Mount

	Pendant		Wall Bracket		Ceiling		Stanchion		Luminaire Body Less Mounting Module & Guard
	Hub Watt	With Guard Size (In.) Cat. #	With Guard Cat. #	With Guard Cat. #	With Guard Cat. #	With Guard Cat. #	With Guard Cat. #		Cat. #
High Pressure Sodium									
70W	1	3/4	EVLP142071	EVLPBX142071	EVLP142071	EVLP142071			EVLP14070
		1 1/4	EVLP143071	EVLPBX143071	EVLP143071	EVLP143071		EVLPJ144071	
100W	1	3/4	EVLP142101	EVLPBX142101	EVLP142101	EVLP142101			EVLP14100
		1 1/4	EVLP143101	EVLPBX143101	EVLP143101	EVLP143101		EVLPJ144101	
150W	1	3/4	EVLP142151	EVLPBX142151	EVLP142151	EVLP142151			EVLP14151
		1 1/4	EVLP143151	EVLPBX143151	EVLP143151	EVLP143151		EVLPJ144151	
Pulse Start Metal Halide									
150W	1	3/4	EVLP192151 S828	EVLPBX192151 S828	EVLP192151 S828	EVLP192151 S828			EVLP19150 S828
		1 1/4	EVLP193151 S828	EVLPBX193151 S828	EVLP193151 S828	EVLP193151 S828		EVLPJ194151 S828	
175W	1	3/4	EVLP192171 S828	EVLPBX192171 S828	EVLP192171 S828	EVLP192171 S828			EVLP19175 S828
		1 1/4	EVLP193171 S828	EVLPBX193171 S828	EVLP193171 S828	EVLP193171 S828		EVLPJ194171 S828	
Metal Halide									
70W	1	3/4	EVLP192071	EVLPBX192071	EVLP192071	EVLP192071			EVLP19070
		1 1/4	EVLP193071	EVLPBX193071	EVLP193071	EVLP193071		EVLPJ194071	
100W	1	3/4	EVLP192101	EVLPBX192101	EVLP192101	EVLP192101			EVLP19100
		1 1/4	EVLP193101	EVLPBX193101	EVLP193101	EVLP193101		EVLPJ194101	
175W	1	3/4	EVLP192171	EVLPBX192171	EVLP192171	EVLP192171			EVLP19175
		1 1/4	EVLP193171	EVLPBX193171	EVLP193171	EVLP193171		EVLPJ194171	

Complete Catalog Number as follows:

Standard Voltage Ballasts – 60Hz					
NEC/UL			CEC/CSA (cUL)		
Voltage Suffix	Multi Tap /MT	120V /120	480V /480	Tri Tap /TT	120V /120
Optional Voltage Ballasts – 50 or 60Hz					
*CEC/CSA (cUL)– CWI Isolated Ballasts				EXPORT	
Voltage Suffix	208V CWI /208CWI	240V CWI /240CWI	600V CWI /600CWI	220V 60Hz /220	220V 50Hz /220 50
				230V 50Hz /230 50	240V 50Hz /240 50

2. 150W HPS Luminaires only

- 55V lamps – add suffix "LX"
- 100V lamps – add suffix "CE"

†Ceiling and bracket mounts have 4 hubs: 3 are plugged.

*CWI Isolated Ballasts are only available for high pressure sodium and 175W metal halide (non pulse start) luminaires.

EVLP Low Profile Hazard•Gard®

Mogul Base

Cl. I, Div. 1, Groups B (GB suffix), C, D
 Cl. I, Zone 1, Groups IIB + H₂
 (with GB suffix), IIB, IIA
 Cl. II, Div. 1, Groups E, F, G; Class III

Marine & Wet Locations
 3, 3R, 4, 4X; IP66

4L

Ordering Information:

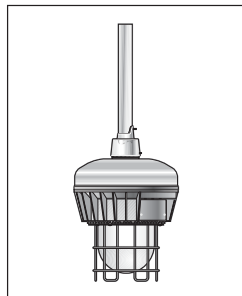

Pendant Mount

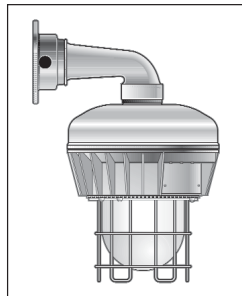

†Wall Bracket Mount

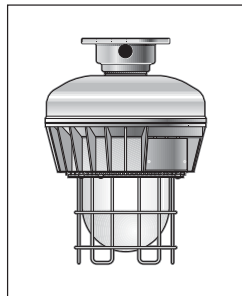

†Ceiling Mount

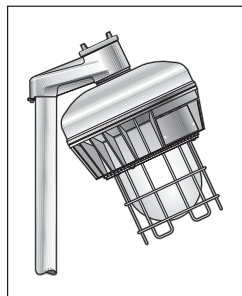

Stanchion Mount

Watt Size (In.)	Pendant		Wall Bracket		Ceiling		Stanchion		Luminaire Body Less Mounting Module & Guard Cat. #
	Hub	With Guard Cat. #	With Guard Cat. #	With Guard Cat. #	With Guard Cat. #	With Guard Cat. #	With Guard Cat. #		
High Pressure Sodium									
70W	3/4	EVLP042071	EVLPBX042071	EVLPBX042071	EVLPXC042071	EVLPXC042071			EVLP04070
	1	EVLP043071	EVLPBX043071	EVLPBX043071	EVLPXC043071	EVLPXC043071			
	1 1/4						EVLPJ044071		
100W	3/4	EVLP042101	EVLPBX042101	EVLPBX042101	EVLPXC042101	EVLPXC042101			EVLP04100
	1	EVLP043101	EVLPBX043101	EVLPBX043101	EVLPXC043101	EVLPXC043101			
	1 1/4						EVLPJ044101		
150W	3/4	EVLP042151	EVLPBX042151	EVLPBX042151	EVLPXC042151	EVLPXC042151			EVLP04150
	1	EVLP043151	EVLPBX043151	EVLPBX043151	EVLPXC043151	EVLPXC043151			
	1 1/4						EVLPJ044151		
Pulse Start Metal Halide									
150W	3/4	EVLP092151S828	EVLPBX092151S828	EVLPBX092151S828	EVLPXC092151S828	EVLPXC092151S828			EVLP09150S828
	1	EVLP093151S828	EVLPBX093151S828	EVLPBX093151S828	EVLPXC093151S828	EVLPXC093151S828			
	1 1/4						EVLPJ094151S828		
175W	3/4	EVLP092171S828	EVLPBX092171S828	EVLPBX092171S828	EVLPXC092171S828	EVLPXC092171S828			EVLP09170S828
	1	EVLP093171S828	EVLPBX093171S828	EVLPBX093171S828	EVLPXC093171S828	EVLPXC093171S828			
	1 1/4						EVLPJ094171S828		
200W	3/4	EVLP092201S828	EVLPBX092201S828	EVLPBX092201S828	EVLPXC092201S828	EVLPXC092201S828			EVLP09201S828
	1	EVLP093201S828	EVLPBX093201S828	EVLPBX093201S828	EVLPXC093201S828	EVLPXC093201S828			
	1 1/4						EVLPJ094201S828		
250W	3/4	EVLP092251S828	EVLPBX092251S828	EVLPBX092251S828	EVLPXC092251S828	EVLPXC092251S828			EVLP09250S828
	1	EVLP093251S828	EVLPBX093251S828	EVLPBX093251S828	EVLPXC093251S828	EVLPXC093251S828			
	1 1/4						EVLPJ094251S828		
Metal Halide									
70W	3/4	EVLP092071	EVLPBX092071	EVLPBX092071	EVLPXC092071	EVLPXC092071			EVLP09070
	1	EVLP093071	EVLPBX093071	EVLPBX093071	EVLPXC093071	EVLPXC093071			
	1 1/4						EVLPJ094071		
100W	3/4	EVLP092101	EVLPBX092101	EVLPBX092101	EVLPXC092101	EVLPXC092101			EVLP09100
	1	EVLP093101	EVLPBX093101	EVLPBX093101	EVLPXC093101	EVLPXC093101			
	1 1/4						EVLPJ094101		
175W	3/4	EVLP092171	EVLPBX092171	EVLPBX092171	EVLPXC092171	EVLPXC092171			EVLP09170
	1	EVLP093171	EVLPBX093171	EVLPBX093171	EVLPXC093171	EVLPXC093171			
	1 1/4						EVLPJ094171		
250W	3/4	EVLP092251	EVLPBX092251	EVLPBX092251	EVLPXC092251	EVLPXC092251			EVLP09250
	1	EVLP093251	EVLPBX093251	EVLPBX093251	EVLPXC093251	EVLPXC093251			
	1 1/4						EVLPJ094251		

Complete Catalog Number as follows:

Standard Voltage Ballasts – 60Hz

1.		NEC/UL		CEC/CSA (cUL)			
Voltage Suffix	Multi Tap /MT	120V /120	480V /480	Tri Tap /TT	120V /120		

Optional Voltage Ballasts – 50 or 60Hz

*CEC/CSA (cUL)– CWI Isolated Ballasts				EXPORT			
Voltage Suffix	208V CWI /208CWI	240V CWI /240CWI	600V CWI /600CWI	220V 60Hz /220	220V 50Hz /220 50	230V 50Hz /230 50	240V 50Hz /240 50

2. 150W HPS Luminaires only

- 55V lamps – add suffix "LX"
- 100V lamps – add suffix "CE"

Example: EVLP043151/MT-LX

†Ceiling and wall bracket mounts have 4 hubs; 3 are plugged.

*CWI Isolated Ballasts are only available for high pressure sodium and 175W–250W metal halide (non pulse start) luminaires.

4L

4L EVLP Low Profile Hazard•Gard®

Ordering by Components

EVLP Luminaires are available in components.

A complete luminaire consists of:

- Mounting Module
- Luminaire Body
- Guard, Dome Reflector or Angle Reflector

Mounting Modules:

Type	Conduit	Cat. #
Pendant	3/4"	EVMP2
	1"	EVMP3
Ceiling & Wall Box	3/4"	EV22
	1"	EV33
Wall Bracket Arm	Use EV22 or EV33 box with EV87	EV87
Stanchion	1 1/4"	EVMJ4
Guards		
Medium		EV511
Mogul		EV512
Reflectors		
Dome		RD739
Angle		RA739

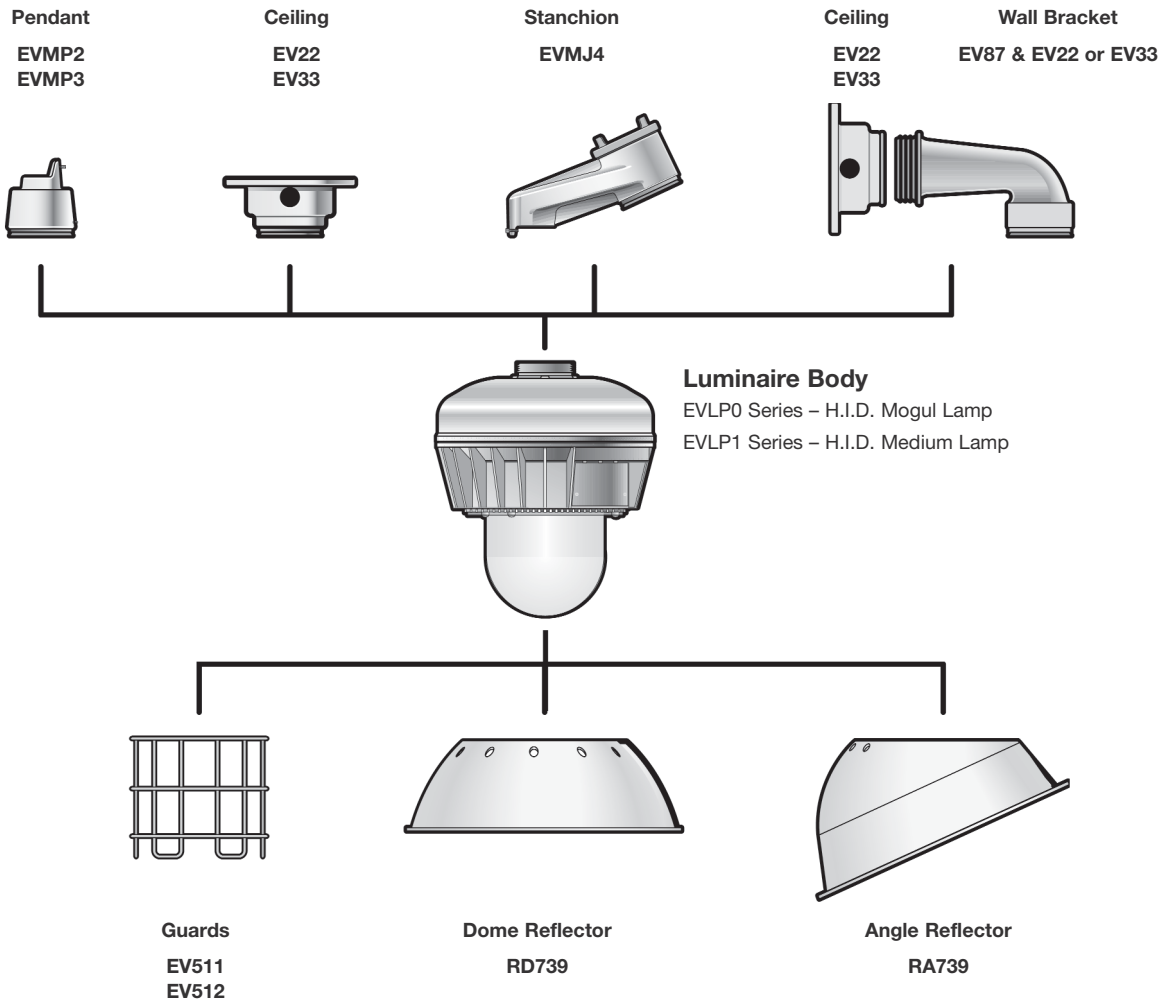

4L

Medium Base Lamp Luminaires:

Maximum Ambient	Watts	Class I, Group B (w/GB suffix) Groups C, D			Class II, Groups E, F, G Class III Simultaneous Presence		Supply Wire °C
		40°C	55°C	65°C	40°C		
High Pressure Sodium	70W	T5	T4A	T4A	T4A		90°C
	100W	T4A	T4A	T4	T4		90°C
	150W	T4	T3C	—	—		90°C
Metal Halide (including pulse start)	70W	T5	T4A	T4A	T4		85°C
	100W	T3C	T3C	—	—		90°C
	150W	T3C	T3B	—	—		90°C
	175W	T3C	T3B	—	—		90°C

Mogul Base Lamp Luminaires:

Maximum Ambient	Watts	Class I, Group B (w/GB suffix) Groups C, D			Class II, Groups E, F, G Class III Simultaneous Presence		Supply Wire °C
		40°C	55°C	65°C	40°C		
High Pressure Sodium	70W	T6	T5	T5	T5		90°C
	100W	T5	T4A	—	T4A		90°C
	150W	T4A	T4	—	T4		90°C
Metal Halide (including pulse start)	70W	T6	T5	T5	T5		85°C
	100W	T5	T4A	T4A	T4A		90°C
	150W	T4	T3C	—	T3C		90°C
	175W	T4	T3C	—	T3C		90°C
	200W	T3C	—	—	—		90°C
	250W	T3C	—	—	—		90°C

4L

4L EVLP Low Profile Hazard•Gard®

Dimensions and Weights

Dimensions In Inches:

	A	B	C	D	E	F
Medium Base	13.92	12.73	16.50	16.71	20.59	19.36
Mogul Base	15.69	14.69	18.25	18.46	22.34	21.30

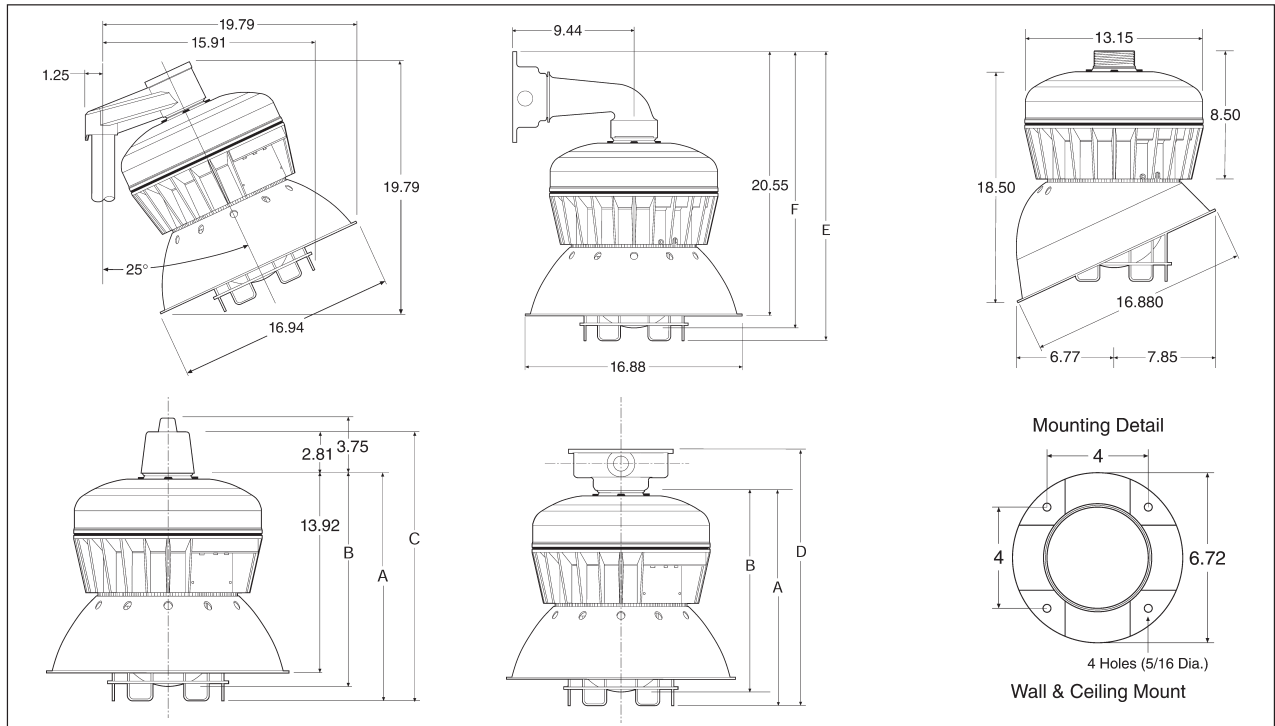

4L Weights (lbs.):

Source	Watts	Luminaire w/guard	
		Medium	Mogul
High Pressure Sodium	70	34	36.5
	100	36	38.5
	150	36.5	39
Metal Halide	70	33.5	36
	100	34.5	37
	150	36	38.5
	175	36	38.5
	200	—	40.5
	250	—	40.5
Add Mounting Modules:		Medium	Mogul
Pendant		1	1
Ceiling		2	2
Bracket		4.5	4.5
Stanchion		2.5	2.5
Add For Reflectors:			
RA739		1	1
RD739		1	1
Deduct for Wire Guard		0.5	0.5

Medium Base

Medium Base

Luminaire with Globe and Guard

EVLP143151 Lamp: 150W/B17 High Pressure Sodium (HPS)

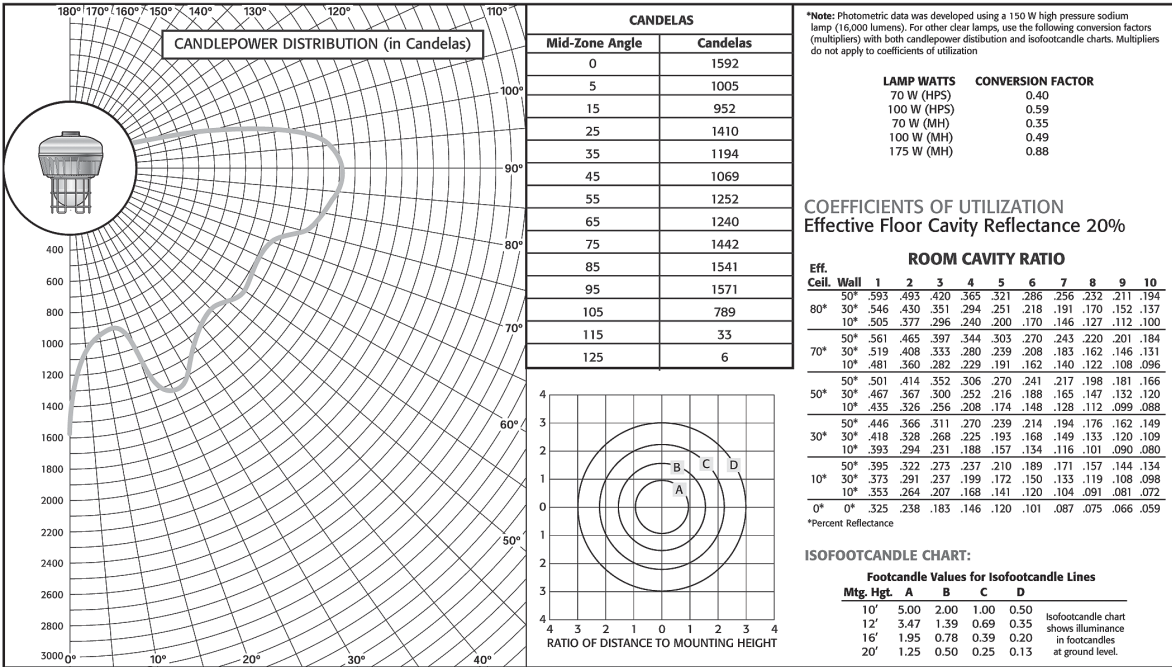

Medium Base

Luminaire with Globe and Dome Reflector (Less Guard)

EVLP143150RD Lamp: 150W/B17 High Pressure Sodium (HPS)

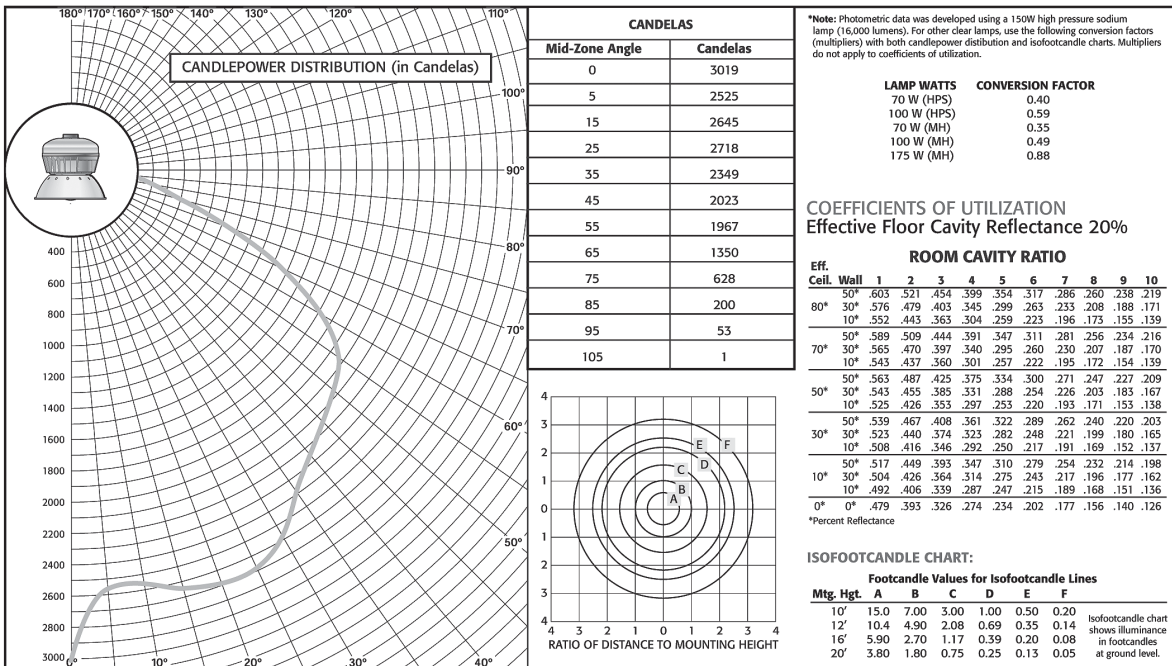

4L

EVLP Low Profile Hazard•Gard®

Photometric Data

Medium and Mogul Base

Medium Base

Luminaire with Globe and 30° Angle Reflector (Less Guard)

EVLP143150RA Lamp: 150W/B17 High Pressure Sodium (HPS)

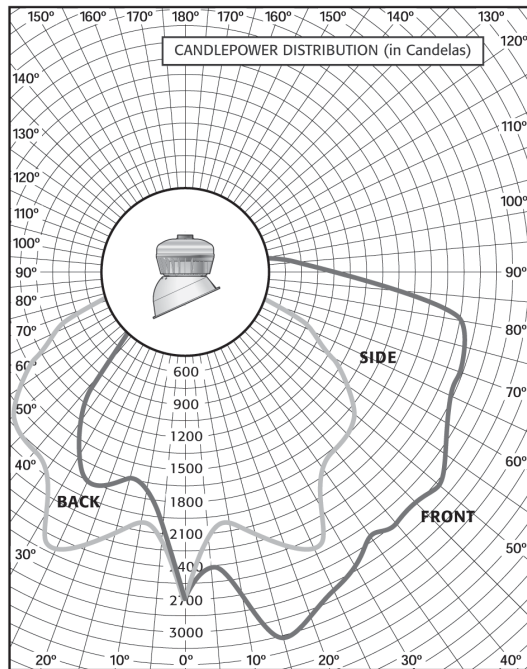

CANDELAS			
Degrees	Front	Side	Back
0	2722	2722	2722
5	2647	2026	1785
15	3047	2283	1754
25	2739	2457	1590
35	2709	1857	882
45	2739	1729	308
55	2483	1159	21
65	2421	790	0
75	2288	205	0
85	934	82	0
95	257	0	31
105	62	0	0
115	0	0	0
125	0	0	0
135	0	0	0
145	0	0	0
155	0	0	0
165	0	0	0
175	0	0	0
180	0	0	0

***Note:** Photometric data was developed using a 150 watt clear high pressure sodium lamp (16,000 lumens). For other clear lamp wattages, use the following conversion factors (multipliers) with both candlepower distribution and isofootcandle charts. Multipliers do not apply to coefficients of utilization.

LAMP WATTS	CONVERSION FACTOR
70 W (HPS)	0.40
100 W (HPS)	0.59
70 W (MH)	0.35
100 W (MH)	0.49
175 W (MH)	0.88

ISOFOOTCANDLE CHART:

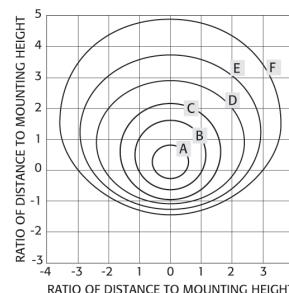

Footcandle Values for Isofootcandle Lines

Mtg. Hgt.	A	B	C	D	E	F
10'	15.00	7.00	3.00	1.00	0.50	0.20
12'	10.40	4.90	2.08	0.69	0.35	0.14
16'	5.90	2.70	1.17	0.39	0.20	0.08
20'	3.80	1.80	0.75	0.25	0.13	0.05

Isofootcandle chart shows illuminance in footcandles at ground level.

Mogul Base

Luminaire with Globe and Guard

EVLP14043151 Lamp: 150W/E23-1/2 High Pressure Sodium (HPS)

4L

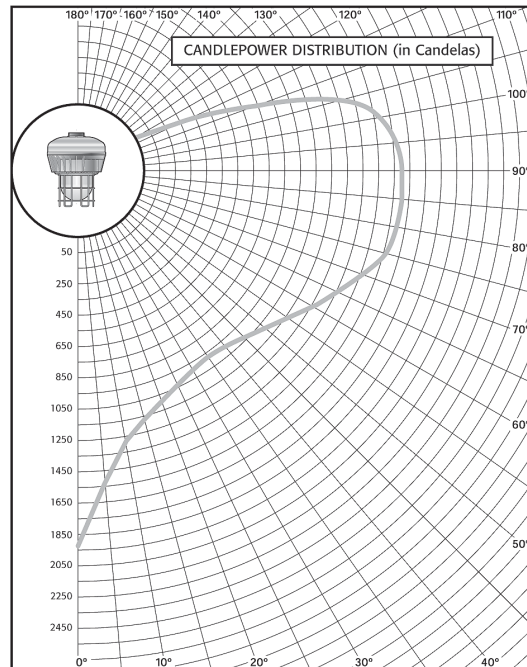

CANDELAS				ZONAL LUMENS	
Mid-Zone Angle	Candelas	With Zone	Lumens		
0	1944	0-10	140		
5	1541	10-20	337		
15	1167	20-30	524		
25	1159	30-40	620		
35	981	40-50	798		
45	1035	50-60	1030		
55	1090	60-70	1353		
65	1348	70-80	1640		
75	1566	80-90	1754		
85	1619	90-100	1749		
95	1612	100-110	1277		
105	1226	110-120	306		
115	265	120-130	19		
125	19	130-140	8		
135	10	140-150	5		
145	7	150-160	3		
155	6	160-170	0		
165	0	170-180	0		
175	0				
180	0				

***Note:** Photometric data was developed using a 150 watt high pressure sodium lamp (16,000 lumens). For other clear lamp wattages, use the following conversion factors (multipliers) with both candlepower distribution and isofootcandle charts. Multipliers do not apply to coefficients of utilization.

LAMP WATTS	CONVERSION FACTOR
70 W (HPS)	0.40
100 W (HPS)	0.59

LUMINAIRE SPACING RATIO — 0.8 (Spacing to mounting height ratio)

COEFFICIENTS OF UTILIZATION Effective Floor Cavity Reflectance 20%

ROOM CAVITY RATIO													
Eff.	Cell.	Wall	0	1	2	3	4	5	6	7	8	9	10
70°	81	69	61	55	50	45	41	38	35	33	31		
80°	50°	81	64	53	45	39	35	31	27	25	22	21	
30°	81	59	46	38	32	27	24	20	18	16	15		
10°	81	55	41	32	26	22	18	16	14	12	11		
70°	77	65	57	51	46	42	39	35	33	31	29		
50°	77	60	50	42	37	33	29	26	23	21	19		
30°	77	56	44	36	30	26	22	19	17	15	14		
10°	77	52	39	30	25	21	17	15	13	11	10		
50°	69	53	44	37	32	29	25	23	21	19	17		
30°	69	49	39	32	27	23	20	17	15	14	12		
10°	69	46	35	27	22	19	16	13	12	10	9		
50°	61	46	38	32	28	25	22	20	18	16	15		
30°	61	44	34	28	24	20	17	15	14	12	11		
10°	61	41	31	24	20	16	14	12	10	9	8		
50°	54	40	33	28	24	21	19	17	16	14	13		
30°	54	38	30	24	20	17	15	13	12	11	10		
10°	54	36	27	21	17	14	12	10	9	8	7		
0°	0°	51	33	24	18	15	12	10	8	7	6	6	

ISOFOOTCANDLE CHART:

Footcandle Values for Isofootcandle Lines

Mtg. Hgt.	A	B	C	D	E
10'	10.00	5.00	2.00	1.00	0.50
12'	6.94	3.47	1.39	0.69	0.35
16'	3.91	1.95	0.78	0.39	0.20
20'	2.50	1.25	0.50	0.25	0.15
25'	1.60	0.80	0.32	0.15	0.08

Isofootcandle chart shows illuminance in footcandles at ground level.

Mogul Base

Mogul Base

Luminaire with Globe and Dome Reflector (Less Guard)

EVLP043150RD Lamp: 150W/E23-1/2 High Pressure Sodium (HPS)

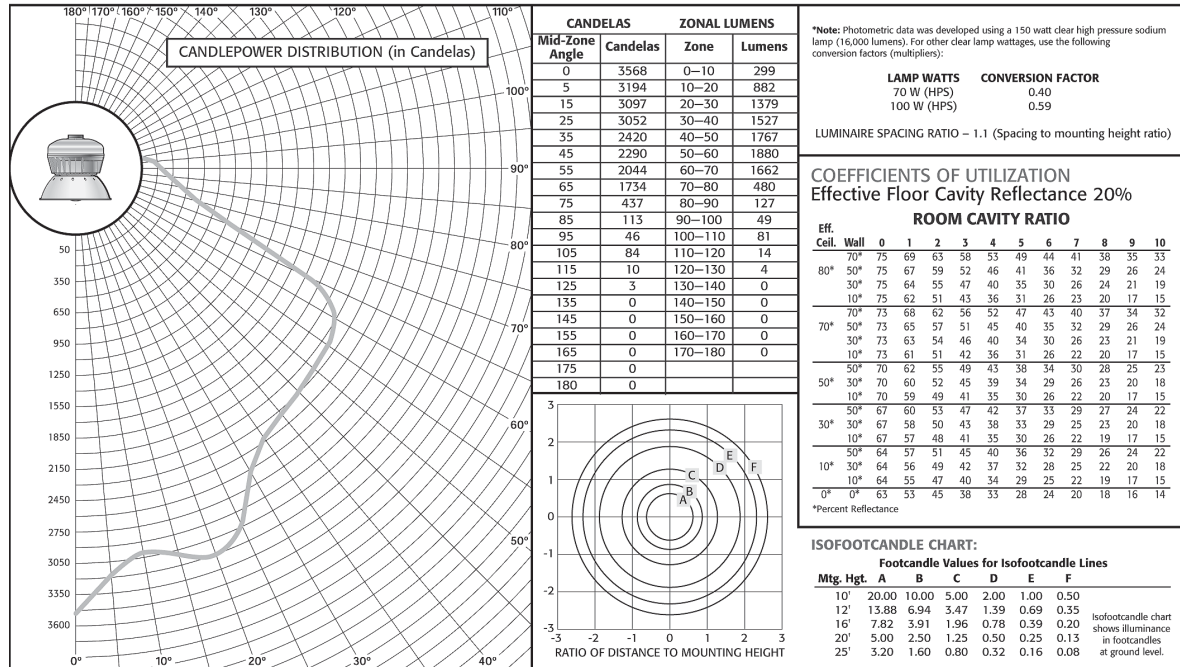

Mogul Base

Luminaire with Globe and 30° Angle Reflector (Less Guard)

EVLP043150RA Lamp: 150W/E23-1/2 High Pressure Sodium (HPS)

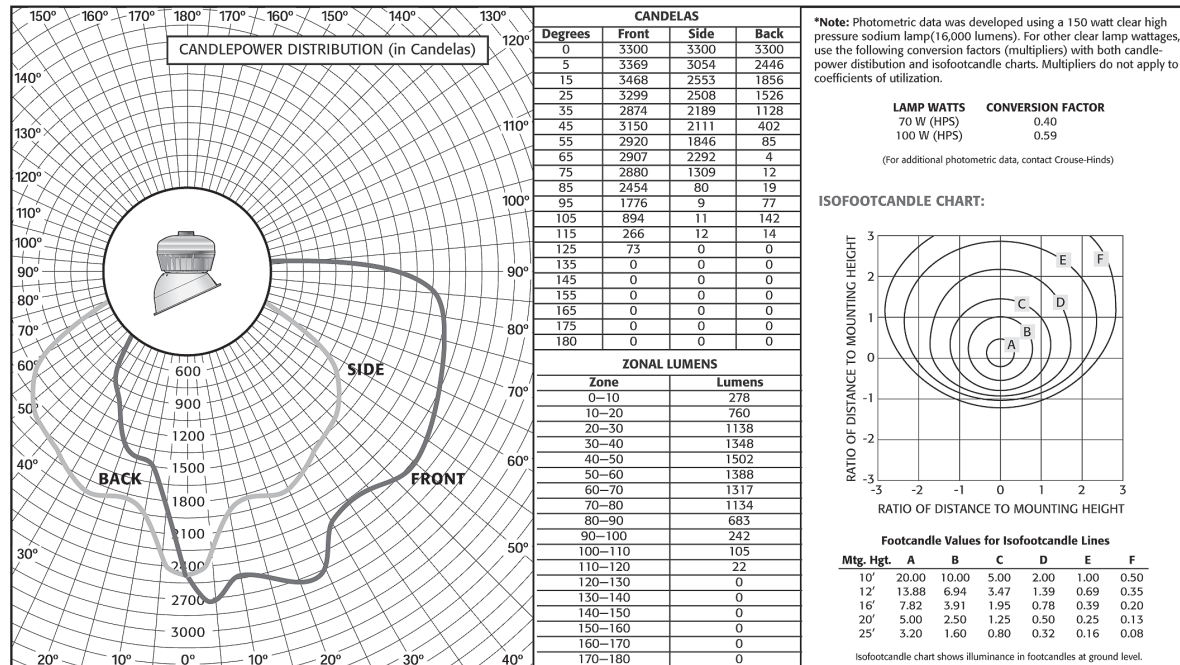

4L

EVLP Low Profile Hazard•Gard®

Mogul Base

Photometric Data

Mogul Base

Luminaire with Globe and Guard

EVLP093171 Lamp: 175W/ED28 Metal Halide (MH)

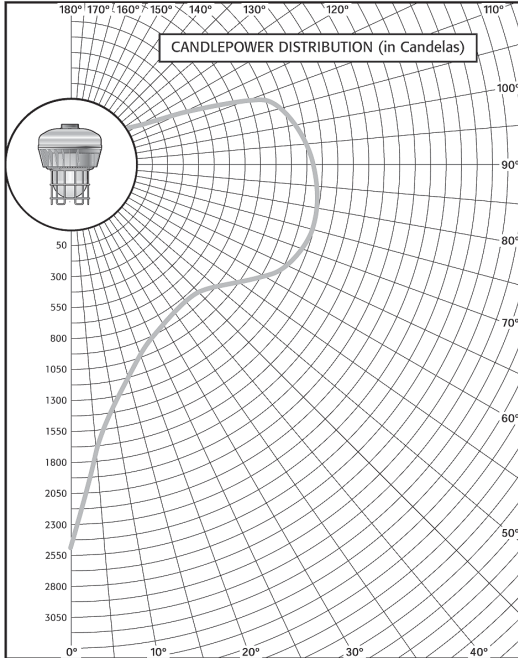

CANDELAS		ZONAL LUMENS	
Mid-Zone Angle	Candelas	Zone	Lumens
0	2439	0-10	158
5	1750	10-20	313
15	1089	20-30	464
25	1017	30-40	563
35	915	40-50	732
45	917	50-60	922
55	1035	60-70	1128
65	1229	70-80	1377
75	1337	80-90	1473
85	1359	90-100	1452
95	1335	100-110	1257
105	1196	110-120	427
115	390	120-130	23
125	24	130-140	9
135	12	140-150	3
145	9	150-160	0
155	0	160-170	0
165	0	170-180	0
175	0		
180	0		

***Note:** Photometric data was developed using a 175 watt clear metal halide lamp (14,000 lumens). For other clear lamp wattages, use the following conversion factors (multipliers) with both candlepower distribution and isofotocandle charts. Multipliers do not apply to coefficients of utilization.

LAMP WATTS	CONVERSION FACTOR
70 W (MH)	0.40
100 W (MH)	0.56
250 W (MH)	1.46

LUMINAIRE SPACING RATIO - 0.4 (Spacing to mounting height ratio)
(For additional photometric data, contact Crouse-Hinds)

COEFFICIENTS OF UTILIZATION
Effective Floor Cavity Reflectance 20%

ROOM CAVITY RATIO

Eff. Ceil. Wall	0	1	2	3	4	5	6	7	8	9	10	
80°	70	82	70	62	56	51	46	43	39	36	34	31
70°	30	61	44	35	28	24	21	18	16	14	13	11
50°	10	82	56	42	33	28	23	19	17	14	13	11
30°	70	78	66	58	52	47	43	40	36	34	31	29
10°	50	78	61	51	44	38	34	30	27	24	22	20
0°	30	78	57	45	37	31	27	23	20	18	16	14
0°	10	78	53	40	32	26	22	18	16	14	12	11
0°	50	69	54	45	38	33	29	26	23	21	19	18
0°	10	69	50	40	33	28	24	21	18	16	14	13
0°	10	69	47	36	28	23	19	16	14	12	11	10
0°	50	61	47	39	33	29	26	23	20	19	17	16
0°	10	61	44	35	28	24	21	18	16	14	13	11
0°	10	61	42	31	25	21	17	15	12	11	10	9
0°	50	54	41	33	28	25	22	20	18	16	15	14
0°	10	54	37	27	22	18	15	13	11	10	8	7
0°	0	51	33	24	19	15	13	11	9	8	7	6

ISOFOOTCANDLE CHART:
Footcandle Values for Isofootcandle Lines

Mtg. Hgt.	A	B	C	D	E	F
10'	20.00	10.00	5.00	2.00	1.00	0.50
12'	13.88	6.94	3.47	1.39	0.69	0.35
16'	7.82	3.91	1.96	0.78	0.39	0.20
20'	5.00	2.50	1.25	0.50	0.25	0.13
25'	3.20	1.60	0.80	0.32	0.16	0.08

Isofootcandle chart shows illuminance in footcandles at ground level.

Mogul Base

Luminaire with Globe and Dome Reflector (Less Guard)

EVLP093170RD Lamp: 175W/ED28 Metal Halide (MH)

4L

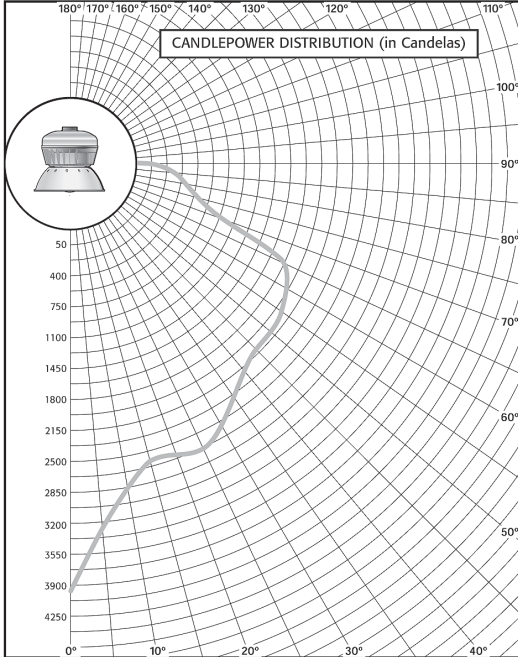

CANDELAS		ZONAL LUMENS	
Mid-Zone Angle	Candelas	Zone	Lumens
0	3941	0-10	300
5	3241	10-20	763
15	2651	20-30	1249
25	2777	30-40	1399
35	2219	40-50	1594
45	2047	50-60	1671
55	1880	60-70	1466
65	1693	70-80	466
75	432	80-90	121
85	102	90-100	20
95	14	100-110	88
105	99	110-120	16
115	13	120-130	2
125	3	130-140	0
135	0	140-150	0
145	0	150-160	0
155	0	160-170	0
165	0	170-180	0
175	0		
180	0		

***Note:** Photometric data was developed using a 175 watt clear metal halide lamp (14,000 lumens). For other clear lamp wattages, use the following conversion factors (multipliers) with both candlepower distribution and isofotocandle charts. Multipliers do not apply to coefficients of utilization.

LAMP WATTS	CONVERSION FACTOR
70 W (MH)	0.40
100 W (MH)	0.56
250 W (MH)	1.46

LUMINAIRE SPACING RATIO - 1.0 (Spacing to mounting height ratio)

COEFFICIENTS OF UTILIZATION
Effective Floor Cavity Reflectance 20%

ROOM CAVITY RATIO

Eff. Ceil. Wall	0	1	2	3	4	5	6	7	8	9	10	
70°	78	71	65	60	55	50	46	42	39	36	34	
80°	50°	78	69	60	53	47	42	37	33	30	27	25
30°	78	66	56	48	42	36	31	27	24	22	20	
10°	78	64	53	44	37	32	27	23	21	18	16	
0°	70°	76	70	64	58	53	49	45	41	38	35	33
0°	50°	76	67	59	52	46	41	37	33	30	27	24
0°	30°	76	65	55	47	41	36	31	27	24	22	19
0°	10°	76	62	52	44	37	32	27	23	20	18	16
0°	50°	72	64	57	50	45	40	35	31	29	26	24
0°	30°	72	62	53	46	40	35	30	27	24	21	19
0°	10°	72	60	51	43	37	31	27	23	20	18	16
0°	50°	69	61	54	48	43	38	34	30	28	25	23
0°	30°	69	60	52	45	39	34	30	26	23	21	19
0°	10°	69	58	49	42	36	31	26	23	20	18	16
0°	50°	66	58	52	46	41	37	33	30	27	24	22
0°	30°	66	58	50	43	38	33	29	26	23	20	18
0°	10°	66	56	48	41	35	30	26	23	20	18	16
0°	0°	65	55	47	40	34	29	25	21	19	16	14

ISOFOOTCANDLE CHART:
Footcandle Values for Isofootcandle Lines

Mtg. Hgt.	A	B	C	D	E	F
10'	20.00	10.00	5.00	2.00	1.00	0.50
12'	13.88	6.94	3.47	1.39	0.69	0.35
16'	7.82	3.91	1.96	0.78	0.39	0.20
20'	5.00	2.50	1.25	0.50	0.25	0.13
25'	3.20	1.60	0.80	0.32	0.16	0.08

Isofootcandle chart shows illuminance in footcandles at ground level.

Mogul Base

Mogul Base

Luminaire with Globe and 30° Angle Reflector (Less Guard)

EVLPA093170RA Lamp: 175W/ED28 Metal Halide (MH)

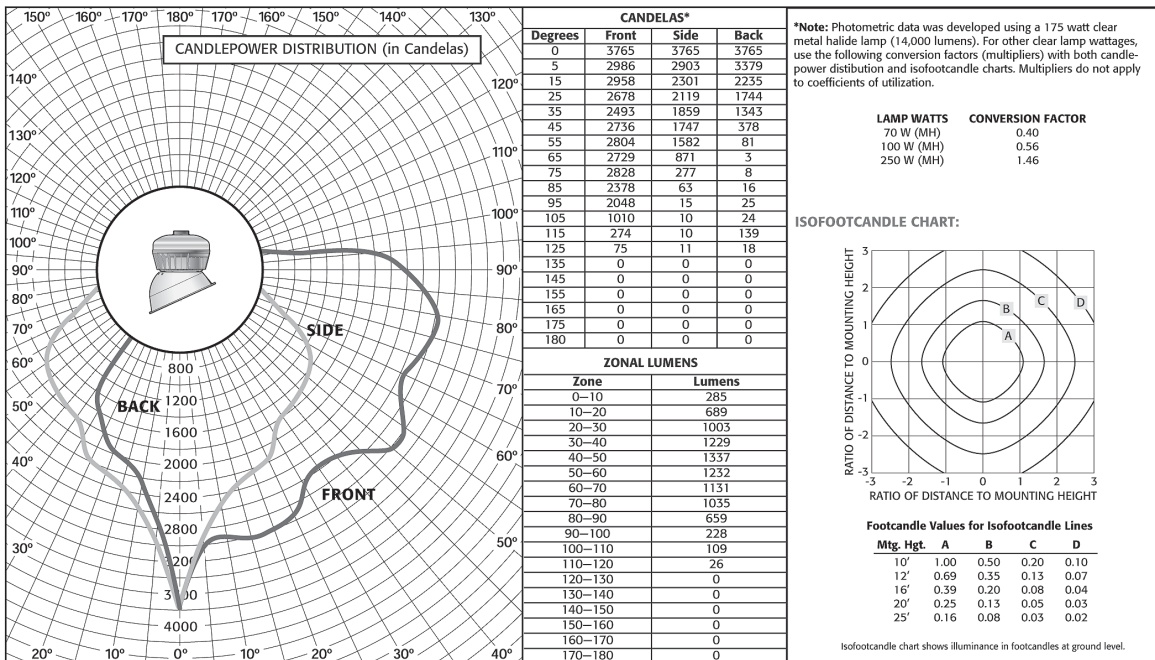

EVLP Low Profile Hazard•Gard® (H.I.D.) Luminaires

Medium and Mogul Base

Cl. I, Div. 1, Groups B (GB suffix), C, D
 Cl. I, Zone 1, Groups IIB + H₂ (with suffix – GB), IIB, IIA
 Cl. II, Div. 1, Groups E, F, G; Class III

Marine & Wet Locations
 3, 3R, 4, 4X; IP66

4L

Applications:

- Eaton's Crouse-Hinds Low Profile Hazard•Gard® luminaires are used in:
- Areas where flammable or explosive vapors or gases are present
 - Hazardous areas, both indoors and outdoors, where long life and low maintenance costs are desired
 - Petroleum refineries, chemical, petrochemical and pharmaceutical plants, oil terminals, gas plants and other heavy process industry facilities
 - Waste treatment facilities
 - Drilling platforms and other coastal and offshore hazardous areas



Features and Benefits:

- Small, compact size is perfect where low mounting restrictions are a concern.
- Two start Acme threaded construction allows for easier assembly, installation and maintenance.
- Lightweight copper-free aluminum housing with powdered epoxy finish for superior corrosion resistance.
- All exterior hardware is corrosion-resistant stainless steel.
- Four mounting arrangements: pendant, ceiling, wall bracket and stanchion suit any lighting layout.
- Wide range of light sources and wattages to meet specific lighting needs.
- Marine and NEMA 4X construction suitable for outdoor, hose down, marine and corrosive environments.
- Integral ballast for lowest installed cost.
- High power factor (90%+) ballasts allows more fixtures per circuit.
- Uses same mounting modules as the standard Hazard•Gard® for easy retrofitting when the EVLP is the preferred choice.
- Internally fluted glass globe reduces glare and distributes light evenly – ideal for adverse environments typical of industrial facilities.
- Krydon® construction dome and angle reflectors – won't rust, corrode, dent, chip or peel
- Now available in components – luminaire body, mounting module, guard, reflectors – allowing for easy stocking for Quick Ship requirements.

Certifications and Compliances:

- NEC and CEC:
 - Class I, Division 1, Groups B (with suffix GB), C, D – All Wattages
 - Class I, Zone 1, Groups IIB + H₂ (with suffix GB), IIB, IIA – All Wattages
 - Class II and Class III
- UL Standards:
 - 844, Hazardous (Classified) Locations
 - 1598 Luminaires
 - 1598A Marine Locations
- CSA Standards
 - C22.2 No. 137

Options:

Description	Suffix
• Group B suitability	GB
• Ballast-Gard™ (HPS only)	BG
• Instant restrike (Mogul Base only)	IR
70–150W LX HPS	
• Cannot use with BG Option	
• Fused (not suitable for marine applications).....	S658*
• Quartz auxiliary lighting (Mogul Base only)	QTZ
• Cannot use with IR option	
• Uses 100W single ended double contract lamp	
• Quartz lamp not included	
• Factory assembled with lamps	FA

*When ordering fuses for luminaires, option S658, you must specify the operating voltage. S658 cannot be ordered with /MT in the catalog number.

Accessories:

Description	Cat. #
Dome reflector	RD739
Angle reflector	RA739

Standard Materials:

- Mounting modules, cover, ballast housing, globe holder – copper-free aluminum
- Globe – heat and impact resistant glass
- Exterior hardware – stainless steel
- Reflectors (dome & angle) – Krydon® fiberglass-reinforced polyester

Standard Finishes:

- Copper-free aluminum – Corro-free™ powdered epoxy
- Krydon – white
- Stainless steel guard

Ratings (Electrical/Size):

Sources/Wattage:

- Medium Base 70–150W HPS, 70–175W MH
- Mogul Base 70–150W HPS, 70–250W MH

Voltages:

- Medium & Mogul H.I.D.
 - 120V 60Hz
 - Multi-tap (120, 208, 240, 277V 60Hz)
 - Tri-tap (120, 277, 347V 60Hz)
 - 480V 60Hz
 - Other voltages – consult Eaton's Crouse-Hinds

Conduit Entries:

- ¾", 1" NPT – pendant, wall bracket, ceiling
- 1¼" NPT – stanchion

4L

4L EVLP Low Profile Hazard•Gard®

Medium Base

Cl. I, Div. 1, Groups B (GB suffix), C, D
 Cl. I, Zone 1, Groups IIB + H₂ (with GB suffix), IIB, IIA
 Cl. II, Div. 1, Groups E, F, G; Class III

Marine & Wet Locations
 3, 3R, 4, 4X; IP66

Ordering Information:

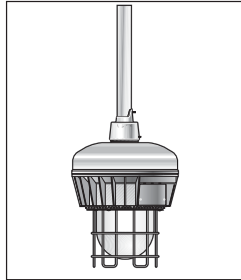

Pendant Mount

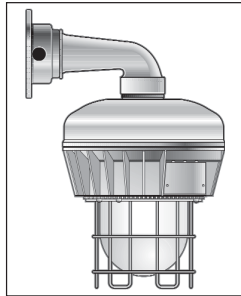

†Wall Bracket Mount

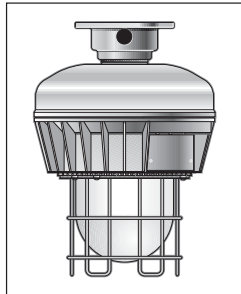

†Ceiling Mount

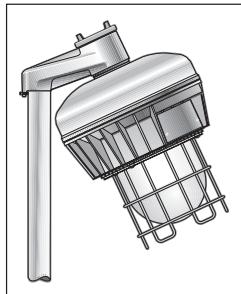

Stanchion Mount

	Pendant		Wall Bracket		Ceiling		Stanchion		Luminaire Body Less Mounting Module & Guard
	Hub Watt	With Guard Size (In.) Cat. #	With Guard Cat. #	With Guard Cat. #	With Guard Cat. #	With Guard Cat. #	With Guard Cat. #		Cat. #
High Pressure Sodium									
70W	3/4	EVLPA142071	EVLPBX142071	EVLPCX142071					EVLPA14070
	1	EVLPA143071	EVLPBX143071	EVLPCX143071					
	1 1/4						EVLPA144071		
100W	3/4	EVLPA142101	EVLPBX142101	EVLPCX142101					EVLPA14100
	1	EVLPA143101	EVLPBX143101	EVLPCX143101					
	1 1/4						EVLPA144101		
150W	3/4	EVLPA142151	EVLPBX142151	EVLPCX142151					EVLPA14151
	1	EVLPA143151	EVLPBX143151	EVLPCX143151					
	1 1/4						EVLPA144151		
Pulse Start Metal Halide									
150W	3/4	EVLPA192151 S828	EVLPBX192151 S828	EVLPCX192151 S828					EVLPA19150 S828
	1	EVLPA193151 S828	EVLPBX193151 S828	EVLPCX193151 S828					
	1 1/4						EVLPA194151 S828		
175W	3/4	EVLPA192171 S828	EVLPBX192171 S828	EVLPCX192171 S828					EVLPA19175 S828
	1	EVLPA193171 S828	EVLPBX193171 S828	EVLPCX193171 S828					
	1 1/4						EVLPA194171 S828		
Metal Halide									
70W	3/4	EVLPA192071	EVLPBX192071	EVLPCX192071					EVLPA19070
	1	EVLPA193071	EVLPBX193071	EVLPCX193071					
	1 1/4						EVLPA194071		
100W	3/4	EVLPA192101	EVLPBX192101	EVLPCX192101					EVLPA19100
	1	EVLPA193101	EVLPBX193101	EVLPCX193101					
	1 1/4						EVLPA194101		
175W	3/4	EVLPA192171	EVLPBX192171	EVLPCX192171					EVLPA19175
	1	EVLPA193171	EVLPBX193171	EVLPCX193171					
	1 1/4						EVLPA194171		

Complete Catalog Number as follows:

Standard Voltage Ballasts – 60Hz

Voltage Suffix	Multi Tap /MT	NEC/UL		CEC/CSA (cUL)	
		120V /120	480V /480	Tri Tap /TT	120V /120

Optional Voltage Ballasts – 50 or 60Hz

Voltage Suffix	*CEC/CSA (cUL)– CWI Isolated Ballasts			EXPORT			
	208V CWI /208CWI	240V CWI /240CWI	600V CWI /600CWI	220V 60Hz /220	220V 50Hz /220 50	230V 50Hz /230 50	240V 50Hz /240 50

2. 150W HPS Luminaires only

- 55V lamps – add suffix "LX"
- 100V lamps – add suffix "CE"

†Ceiling and bracket mounts have 4 hubs: 3 are plugged.

*CWI Isolated Ballasts are only available for high pressure sodium and 175W metal halide (non pulse start) luminaires.

EVLP Low Profile Hazard•Gard®

Mogul Base

Cl. I, Div. 1, Groups B (GB suffix), C, D
 Cl. I, Zone 1, Groups IIB + H₂
 (with GB suffix), IIB, IIA
 Cl. II, Div. 1, Groups E, F, G; Class III

Marine & Wet Locations
 3, 3R, 4, 4X; IP66

4L

Ordering Information:

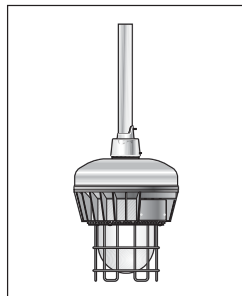

Pendant Mount

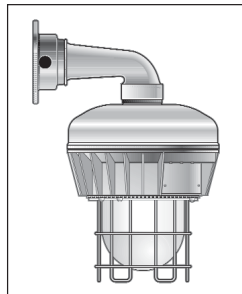

†Wall Bracket Mount

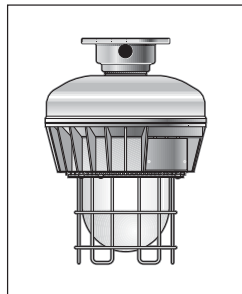

†Ceiling Mount

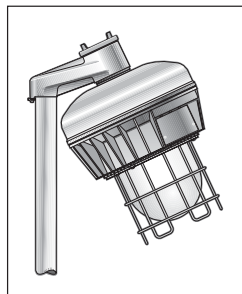

Stanchion Mount

Watt Size (In.)	Pendant		Wall Bracket		Ceiling		Stanchion		Luminaire Body Less Mounting Module & Guard Cat. #
	Hub	With Guard Cat. #	With Guard Cat. #	With Guard Cat. #	With Guard Cat. #	With Guard Cat. #	With Guard Cat. #		
High Pressure Sodium									
70W	3/4	EVLPA042071	EVLPBX042071	EVLPBX042071	EVLPBX042071	EVLPBX042071			EVLP04070
	1	EVLPA043071	EVLPBX043071	EVLPBX043071	EVLPBX043071	EVLPBX043071			
	1 1/4						EVLPJ044071		
100W	3/4	EVLPA042101	EVLPBX042101	EVLPBX042101	EVLPBX042101	EVLPBX042101			EVLP04100
	1	EVLPA043101	EVLPBX043101	EVLPBX043101	EVLPBX043101	EVLPBX043101			
	1 1/4						EVLPJ044101		
150W	3/4	EVLPA042151	EVLPBX042151	EVLPBX042151	EVLPBX042151	EVLPBX042151			EVLP04150
	1	EVLPA043151	EVLPBX043151	EVLPBX043151	EVLPBX043151	EVLPBX043151			
	1 1/4						EVLPJ044151		
Pulse Start Metal Halide									
150W	3/4	EVLPA092151S828	EVLPBX092151S828	EVLPBX092151S828	EVLPBX092151S828	EVLPBX092151S828			EVLP09150S828
	1	EVLPA093151S828	EVLPBX093151S828	EVLPBX093151S828	EVLPBX093151S828	EVLPBX093151S828			
	1 1/4						EVLPJ094151S828		
175W	3/4	EVLPA092171S828	EVLPBX092171S828	EVLPBX092171S828	EVLPBX092171S828	EVLPBX092171S828			EVLP09170S828
	1	EVLPA093171S828	EVLPBX093171S828	EVLPBX093171S828	EVLPBX093171S828	EVLPBX093171S828			
	1 1/4						EVLPJ094171S828		
200W	3/4	EVLPA092201S828	EVLPBX092201S828	EVLPBX092201S828	EVLPBX092201S828	EVLPBX092201S828			EVLP09201S828
	1	EVLPA093201S828	EVLPBX093201S828	EVLPBX093201S828	EVLPBX093201S828	EVLPBX093201S828			
	1 1/4						EVLPJ094201S828		
250W	3/4	EVLPA092251S828	EVLPBX092251S828	EVLPBX092251S828	EVLPBX092251S828	EVLPBX092251S828			EVLP09250S828
	1	EVLPA093251S828	EVLPBX093251S828	EVLPBX093251S828	EVLPBX093251S828	EVLPBX093251S828			
	1 1/4						EVLPJ094251S828		
Metal Halide									
70W	3/4	EVLPA092071	EVLPBX092071	EVLPBX092071	EVLPBX092071	EVLPBX092071			EVLP09070
	1	EVLPA093071	EVLPBX093071	EVLPBX093071	EVLPBX093071	EVLPBX093071			
	1 1/4						EVLPJ094071		
100W	3/4	EVLPA092101	EVLPBX092101	EVLPBX092101	EVLPBX092101	EVLPBX092101			EVLP09100
	1	EVLPA093101	EVLPBX093101	EVLPBX093101	EVLPBX093101	EVLPBX093101			
	1 1/4						EVLPJ094101		
175W	3/4	EVLPA092171	EVLPBX092171	EVLPBX092171	EVLPBX092171	EVLPBX092171			EVLP09170
	1	EVLPA093171	EVLPBX093171	EVLPBX093171	EVLPBX093171	EVLPBX093171			
	1 1/4						EVLPJ094171		
250W	3/4	EVLPA092251	EVLPBX092251	EVLPBX092251	EVLPBX092251	EVLPBX092251			EVLP09250
	1	EVLPA093251	EVLPBX093251	EVLPBX093251	EVLPBX093251	EVLPBX093251			
	1 1/4						EVLPJ094251		

Complete Catalog Number as follows:

Standard Voltage Ballasts – 60Hz

1.		NEC/UL		CEC/CSA (cUL)			
Voltage Suffix	Multi Tap /MT	120V /120	480V /480	Tri Tap /TT	120V /120		

Optional Voltage Ballasts – 50 or 60Hz

*CEC/CSA (cUL)– CWI Isolated Ballasts				EXPORT			
Voltage Suffix	208V CWI /208CWI	240V CWI /240CWI	600V CWI /600CWI	220V 60Hz /220	220V 50Hz /220 50	230V 50Hz /230 50	240V 50Hz /240 50

2. 150W HPS Luminaires only

- 55V lamps – add suffix "LX"
- 100V lamps – add suffix "CE"

Example: EVLPA043151/MT-LX

†Ceiling and wall bracket mounts have 4 hubs; 3 are plugged.

*CWI Isolated Ballasts are only available for high pressure sodium and 175W–250W metal halide (non pulse start) luminaires.

4L EVLP Low Profile Hazard•Gard®

Ordering by Components

EVLP Luminaires are available in components.

A complete luminaire consists of:

- Mounting Module
- Luminaire Body
- Guard, Dome Reflector or Angle Reflector

Mounting Modules:

Type	Conduit	Cat. #
Pendant	3/4"	EVMP2
	1"	EVMP3
Ceiling & Wall Box	3/4"	EV22
	1"	EV33
Wall Bracket Arm	Use EV22 or EV33 box with EV87	EV87
Stanchion	1 1/4"	EVMJ4
Guards		
Medium		EV511
Mogul		EV512
Reflectors		
Dome		RD739
Angle		RA739

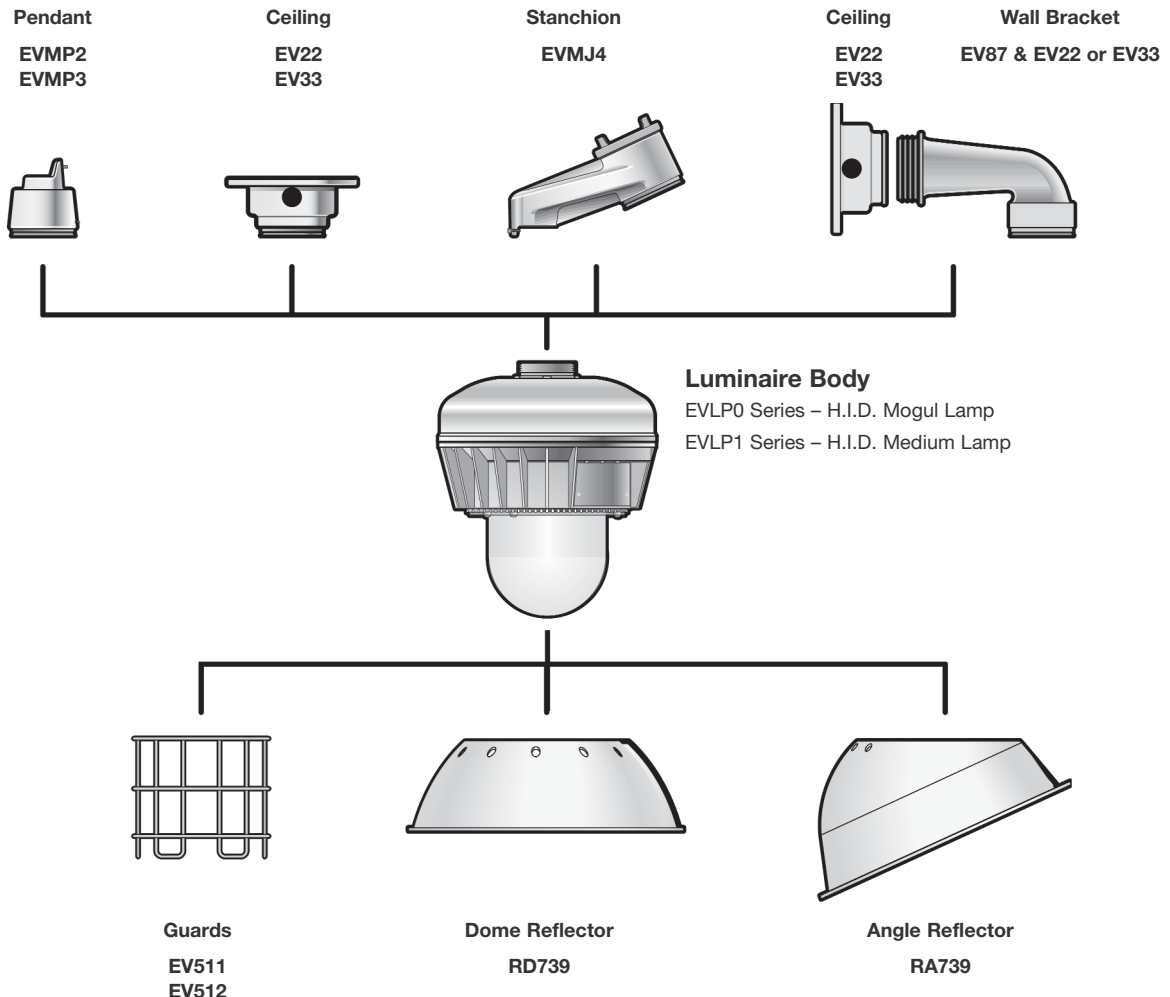

4L

Medium Base Lamp Luminaires:

Maximum Ambient	Watts	Class I, Group B (w/GB suffix) Groups C, D			Class II, Groups E, F, G Class III Simultaneous Presence		Supply Wire °C
		40°C	55°C	65°C	40°C		
High Pressure Sodium	70W	T5	T4A	T4A	T4A		90°C
	100W	T4A	T4A	T4	T4		90°C
	150W	T4	T3C	—	—		90°C
Metal Halide (including pulse start)	70W	T5	T4A	T4A	T4		85°C
	100W	T3C	T3C	—	—		90°C
	150W	T3C	T3B	—	—		90°C
	175W	T3C	T3B	—	—		90°C

Mogul Base Lamp Luminaires:

Maximum Ambient	Watts	Class I, Group B (w/GB suffix) Groups C, D			Class II, Groups E, F, G Class III Simultaneous Presence		Supply Wire °C
		40°C	55°C	65°C	40°C		
High Pressure Sodium	70W	T6	T5	T5	T5		90°C
	100W	T5	T4A	—	T4A		90°C
	150W	T4A	T4	—	T4		90°C
Metal Halide (including pulse start)	70W	T6	T5	T5	T5		85°C
	100W	T5	T4A	T4A	T4A		90°C
	150W	T4	T3C	—	T3C		90°C
	175W	T4	T3C	—	T3C		90°C
	200W	T3C	—	—	—		90°C
	250W	T3C	—	—	—		90°C

4L

4L EVLP Low Profile Hazard•Gard®

Dimensions and Weights

Dimensions In Inches:

	A	B	C	D	E	F
Medium Base	13.92	12.73	16.50	16.71	20.59	19.36
Mogul Base	15.69	14.69	18.25	18.46	22.34	21.30

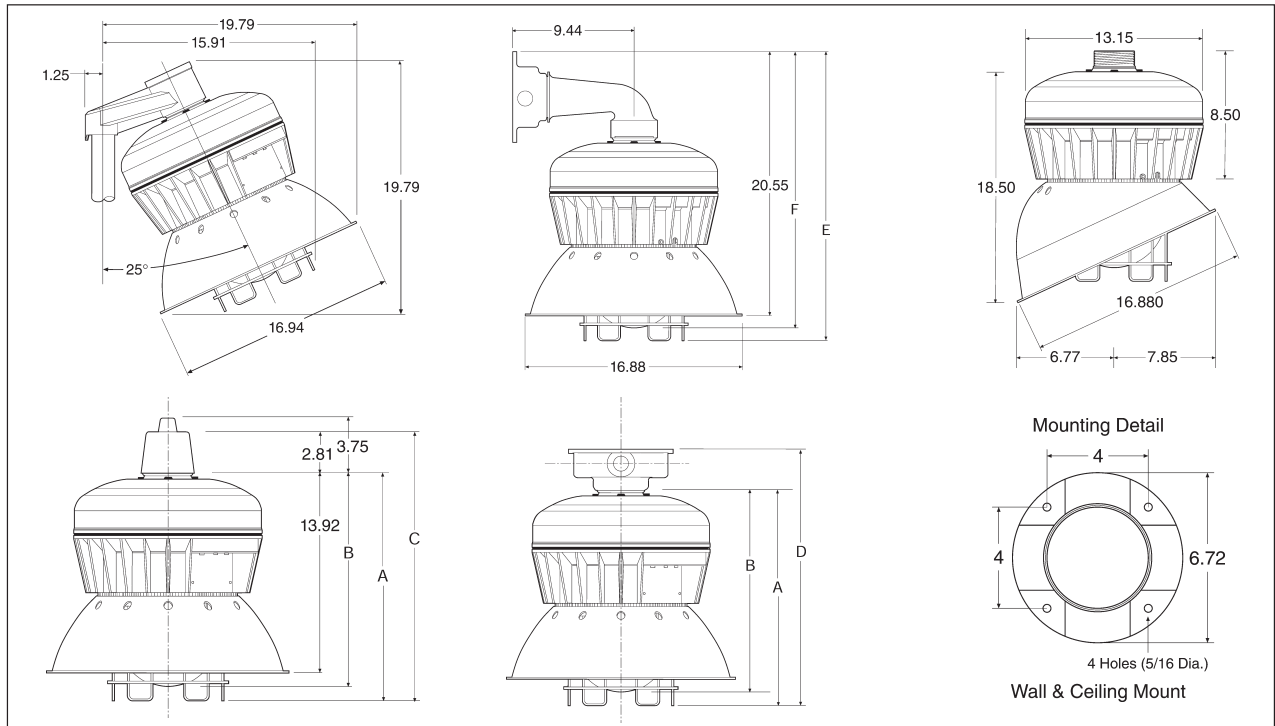

4L Weights (lbs.):

Source	Watts	Luminaire w/guard	
		Medium	Mogul
High Pressure Sodium	70	34	36.5
	100	36	38.5
	150	36.5	39
Metal Halide	70	33.5	36
	100	34.5	37
	150	36	38.5
	175	36	38.5
	200	—	40.5
	250	—	40.5
Add Mounting Modules:		Medium	Mogul
Pendant		1	1
Ceiling		2	2
Bracket		4.5	4.5
Stanchion		2.5	2.5
Add For Reflectors:			
RA739		1	1
RD739		1	1
Deduct for Wire Guard		0.5	0.5

Medium Base

Medium Base

Luminaire with Globe and Guard

EVLP143151 Lamp: 150W/B17 High Pressure Sodium (HPS)

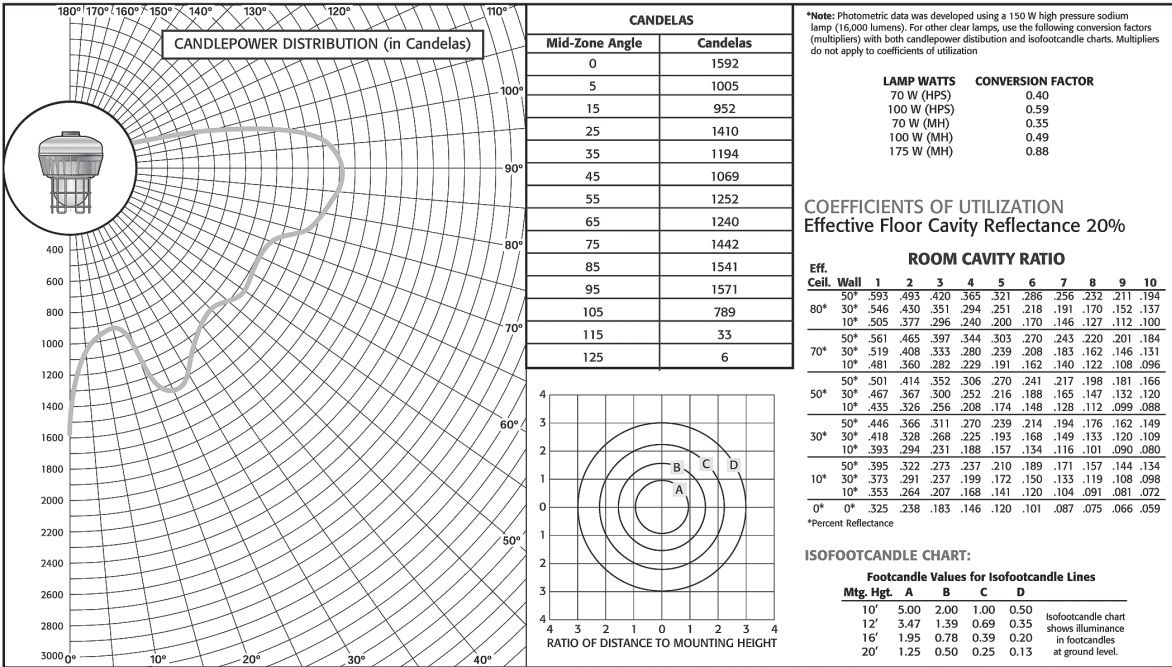

Medium Base

Luminaire with Globe and Dome Reflector (Less Guard)

EVLP143150RD Lamp: 150W/B17 High Pressure Sodium (HPS)

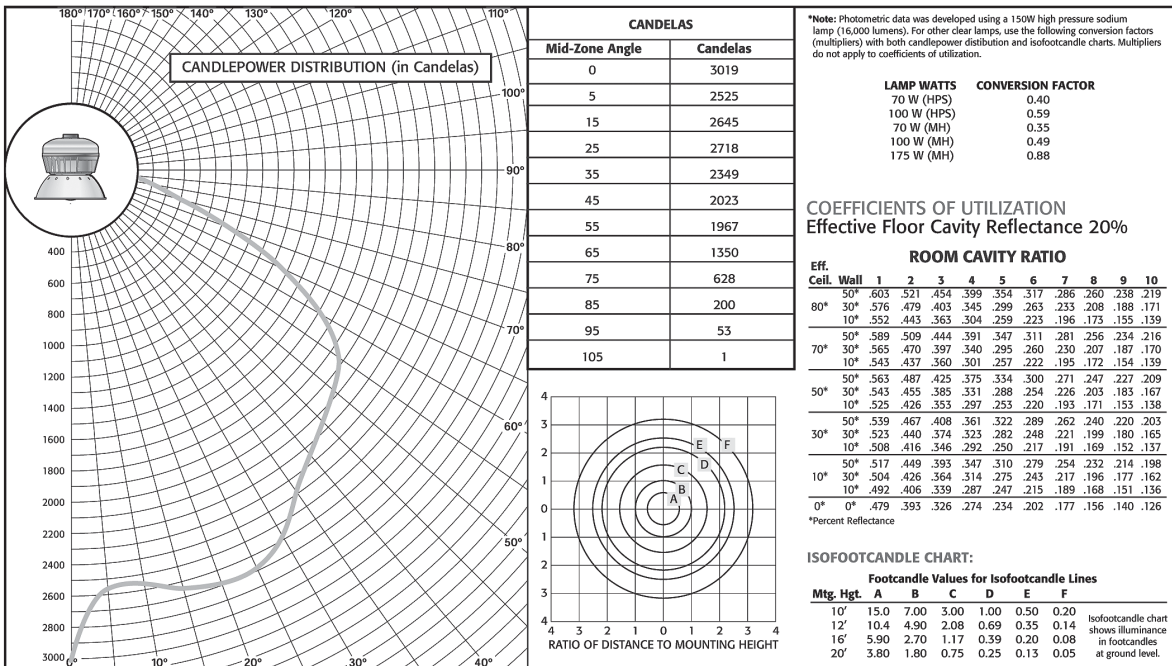

4L

EVLP Low Profile Hazard•Gard®

Photometric Data

Medium and Mogul Base

Medium Base

Luminaire with Globe and 30° Angle Reflector (Less Guard)

EVLP143150RA Lamp: 150W/B17 High Pressure Sodium (HPS)

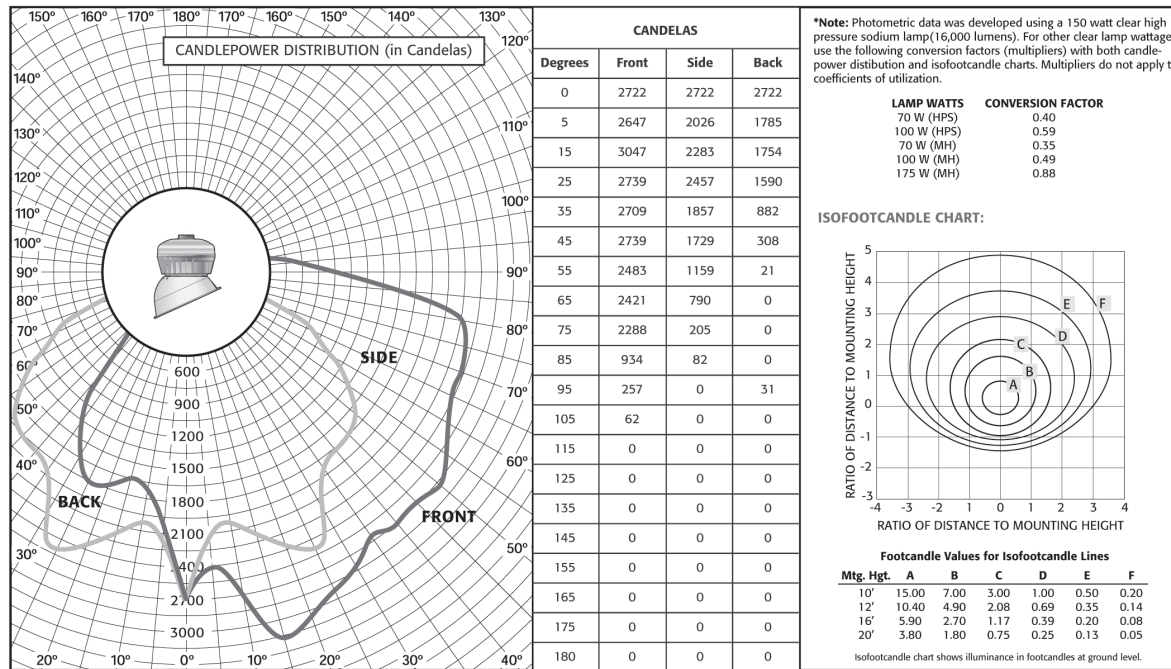

Mogul Base

Luminaire with Globe and Guard

EVLP14043151 Lamp: 150W/E23-1/2 High Pressure Sodium (HPS)

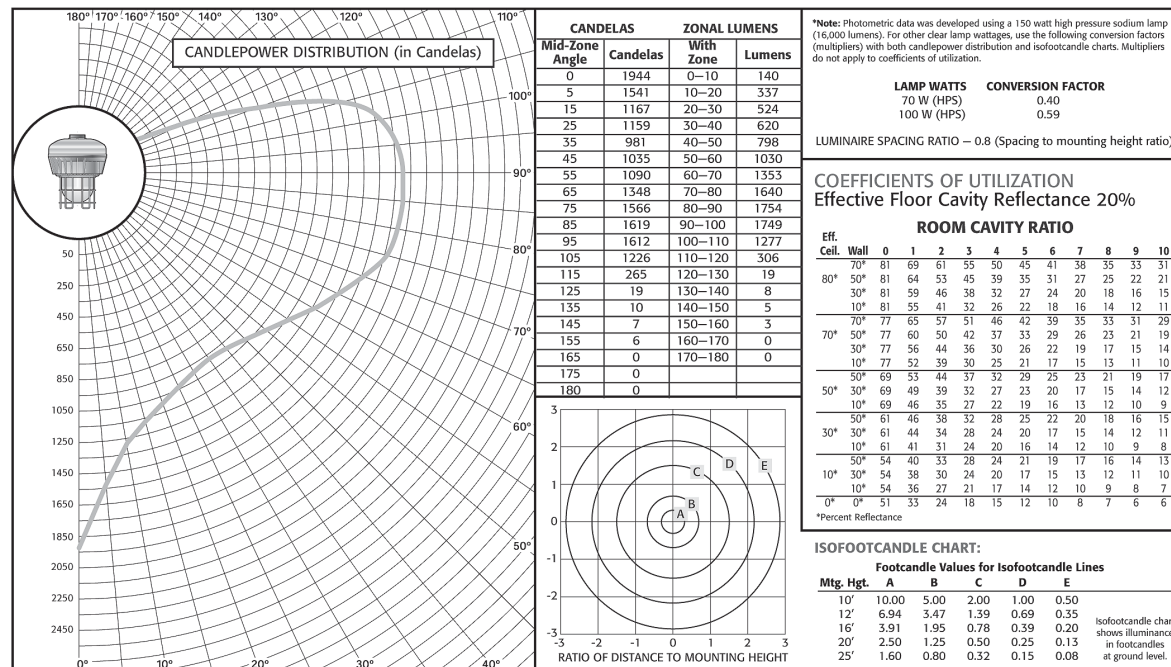

Mogul Base

Mogul Base

Luminaire with Globe and Dome Reflector (Less Guard)

EVLP043150RD Lamp: 150W/E23-1/2 High Pressure Sodium (HPS)

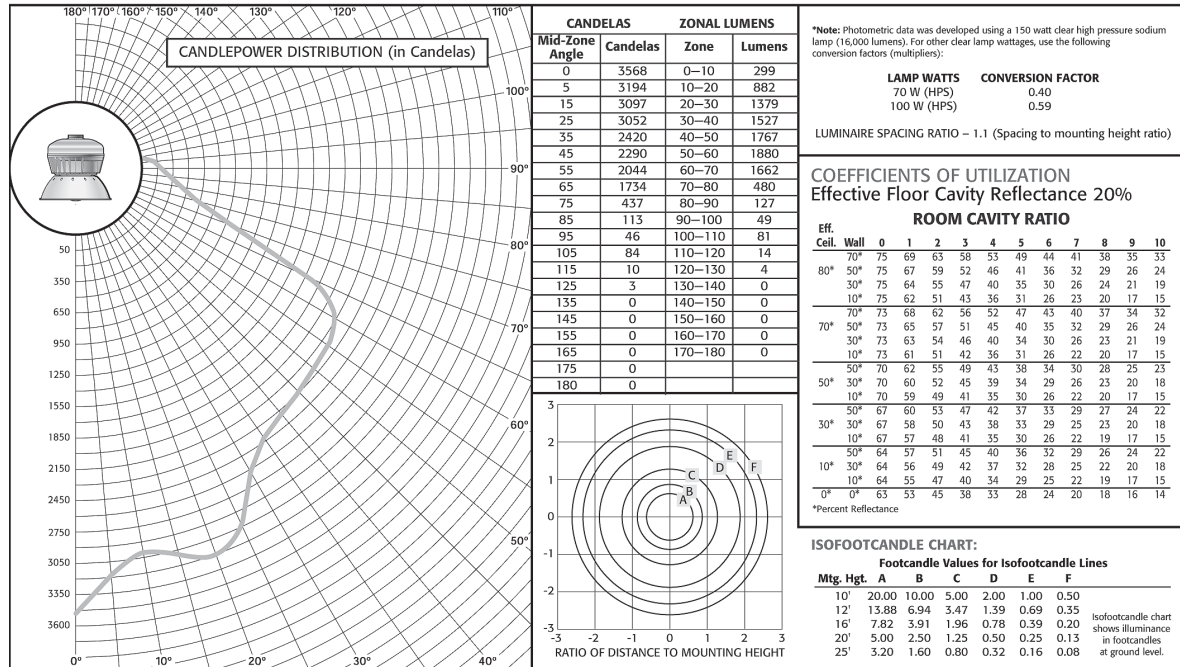

Mogul Base

Luminaire with Globe and 30° Angle Reflector (Less Guard)

EVLP043150RA Lamp: 150W/E23-1/2 High Pressure Sodium (HPS)

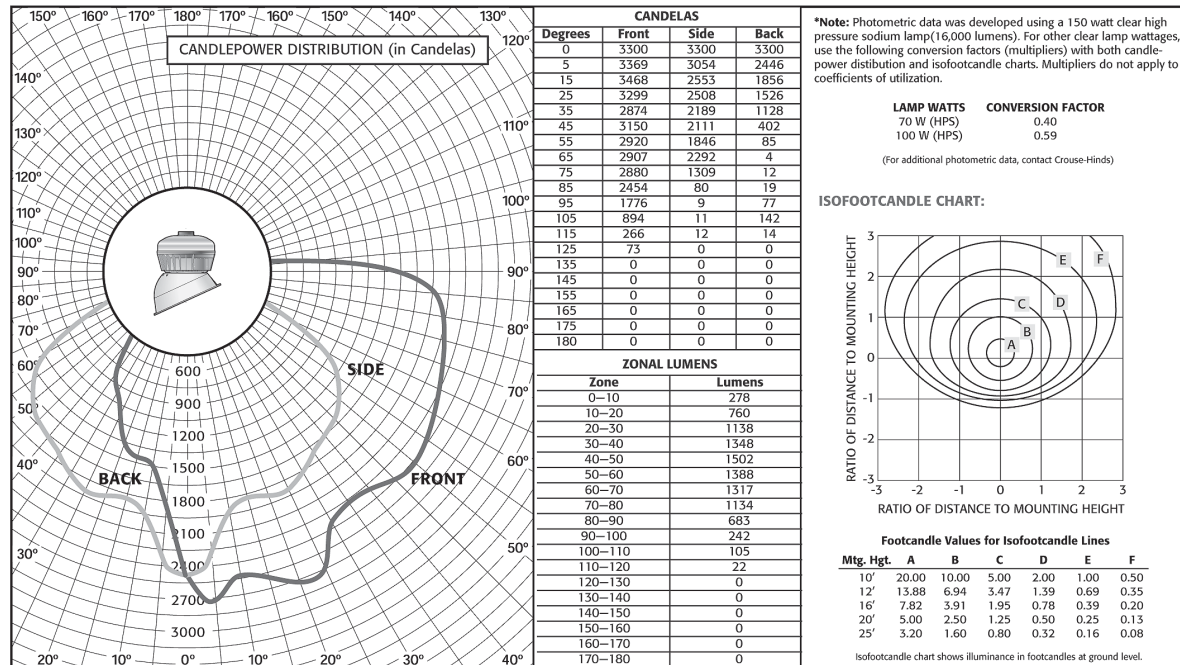

4L

EVLP Low Profile Hazard•Gard®

Mogul Base

Photometric Data

Mogul Base

Luminaire with Globe and Guard

EVLP093171 Lamp: 175W/ED28 Metal Halide (MH)

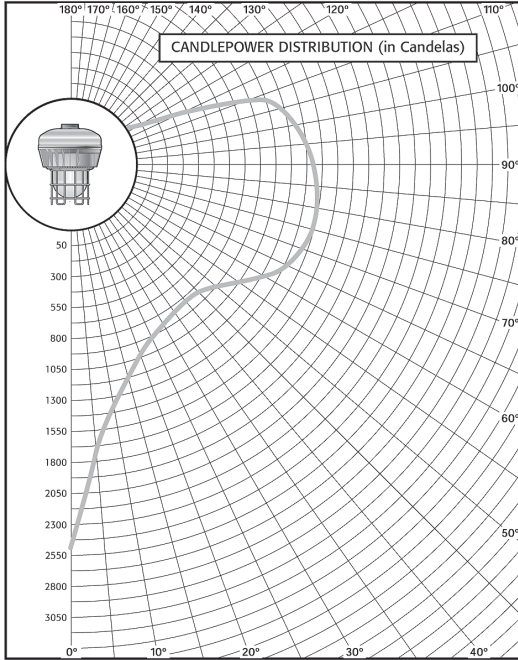

CANDELAS		ZONAL LUMENS	
Mid-Zone Angle	Candelas	Zone	Lumens
0	2439	0-10	158
5	1750	10-20	313
15	1089	20-30	464
25	1017	30-40	563
35	915	40-50	732
45	917	50-60	922
55	1035	60-70	1128
65	1229	70-80	1377
75	1337	80-90	1473
85	1359	90-100	1452
95	1335	100-110	1257
105	1196	110-120	427
115	390	120-130	23
125	24	130-140	9
135	12	140-150	3
145	9	150-160	0
155	0	160-170	0
165	0	170-180	0
175	0		
180	0		

ISOFOOTCANDLE CHART	
Footcandle Values for Isofootcandle Lines	
Mtg. Hgt.	A B C D E F
10'	20.00 10.00 5.00 2.00 1.00 0.50
12'	13.88 6.94 3.47 1.39 0.69 0.35
16'	7.82 3.91 1.96 0.78 0.39 0.20
20'	5.00 2.50 1.25 0.50 0.25 0.13
25'	3.20 1.60 0.80 0.32 0.16 0.08

*Note: Photometric data was developed using a 175 watt clear metal halide lamp (14,000 lumens). For other clear lamp wattages, use the following conversion factors (multipliers) with both candlepower distribution and isofootcandle charts. Multipliers do not apply to coefficients of utilization.

LAMP WATTS	CONVERSION FACTOR
70 W (MH)	0.40
100 W (MH)	0.56
250 W (MH)	1.46

LUMINAIRE SPACING RATIO - 0.4 (Spacing to mounting height ratio)
(For additional photometric data, contact Crouse-Hinds)

COEFFICIENTS OF UTILIZATION
Effective Floor Cavity Reflectance 20%

ROOM CAVITY RATIO	
Eff. Ceil. Wall	0 1 2 3 4 5 6 7 8 9 10
80°	70 82 70 62 56 51 46 43 39 36 34 31
50°	30 61 44 35 28 24 21 18 16 14 13 11
10°	82 56 42 33 28 23 19 17 14 13 11
70°	70 78 66 58 52 47 43 40 36 34 31 29
50°	30 69 50 40 33 28 24 21 18 16 14 13
10°	78 53 40 32 26 22 18 16 14 12 11
50°	50 69 54 45 38 33 29 26 23 21 19 18
10°	69 47 36 28 23 19 16 14 12 11 10
30°	50 61 47 39 33 29 26 23 20 19 17 16
10°	61 42 31 25 21 17 15 12 11 10 9
50°	50 54 41 33 28 25 22 20 18 16 15 14
10°	54 37 27 22 18 15 13 11 10 8 7
0°	0 51 33 24 19 15 13 11 9 8 7 6

*Percent Reflectance

Mogul Base

Luminaire with Globe and Dome Reflector (Less Guard)

EVLP093170RD Lamp: 175W/ED28 Metal Halide (MH)

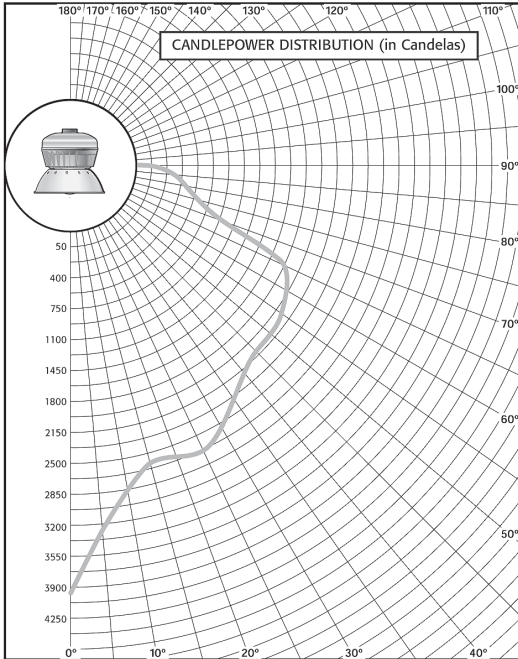

CANDELAS		ZONAL LUMENS	
Mid-Zone Angle	Candelas	Zone	Lumens
0	3941	0-10	300
5	3241	10-20	763
15	2651	20-30	1249
25	2777	30-40	1399
35	2219	40-50	1594
45	2047	50-60	1671
55	1880	60-70	1466
65	1693	70-80	466
75	432	80-90	121
85	102	90-100	20
95	14	100-110	88
105	99	110-120	16
115	13	120-130	2
125	3	130-140	0
135	0	140-150	0
145	0	150-160	0
155	0	160-170	0
165	0	170-180	0
175	0		
180	0		

ISOFOOTCANDLE CHART	
Footcandle Values for Isofootcandle Lines	
Mtg. Hgt.	A B C D E F
10'	20.00 10.00 5.00 2.00 1.00 0.50
12'	13.88 6.94 3.47 1.39 0.69 0.35
16'	7.82 3.91 1.96 0.78 0.39 0.20
20'	5.00 2.50 1.25 0.50 0.25 0.13
25'	3.20 1.60 0.80 0.32 0.16 0.08

*Note: Photometric data was developed using a 175 watt clear metal halide lamp (14,000 lumens). For other clear lamp wattages, use the following conversion factors (multipliers) with both candlepower distribution and isofootcandle charts. Multipliers do not apply to coefficients of utilization.

LAMP WATTS	CONVERSION FACTOR
70 W (MH)	0.40
100 W (MH)	0.56
250 W (MH)	1.46

LUMINAIRE SPACING RATIO - 1.0 (Spacing to mounting height ratio)

COEFFICIENTS OF UTILIZATION
Effective Floor Cavity Reflectance 20%

ROOM CAVITY RATIO	
Eff. Ceil. Wall	0 1 2 3 4 5 6 7 8 9 10
70°	78 71 65 60 55 50 46 42 39 36 34
80°	50° 78 69 60 53 47 42 37 33 30 27 25
30°	78 66 56 48 42 36 31 27 24 22 20
10°	78 64 53 44 37 32 27 23 21 18 16
70°	76 70 64 58 53 49 45 41 38 35 33
50°	76 67 59 52 46 41 37 33 30 27 24
10°	76 65 55 47 41 36 31 27 24 22 19
10°	76 62 52 44 37 32 27 23 20 18 16
50°	72 64 57 50 45 40 35 31 29 26 24
50°	72 62 53 46 40 35 30 27 24 21 19
10°	72 60 51 43 37 31 27 23 20 18 16
30°	69 61 54 48 43 38 34 30 28 25 23
30°	69 60 52 45 39 34 30 26 23 21 19
10°	69 58 49 42 36 31 26 23 20 18 16
50°	66 58 52 46 41 37 33 30 27 24 22
30°	66 58 50 43 38 33 29 26 23 20 18
10°	66 56 48 41 35 30 26 23 20 18 16
0°	0° 65 55 47 40 34 29 25 21 19 16 14

*Percent Reflectance

4L

Mogul Base

Mogul Base

Luminaire with Globe and 30° Angle Reflector (Less Guard)

EVLPA093170RA Lamp: 175W/ED28 Metal Halide (MH)

