

Sealing Fittings

Explosionproof; Dust-Ignitionproof

UNILETS® for Use with Threaded Rigid Metal Conduit and IMC.

Applications

- Prevent passage of gases, vapors or flames from one portion of conduit system to another. Restrict any explosion to the sealed off enclosure. Prevent pressure piling within conduit system.
- Required in Class I, Division 1 and 2 locations within 18" of enclosures containing apparatus that may cause arcs, sparks or high temperatures.
- Required in Class I, Division 1 and 2 locations where 2" or larger conduit enters enclosure, fitting housing terminals, splices or taps.
- Required in Class I, Division 1 and 2 locations at the boundary where conduit leaves classified location.
- Required in Class I, Division 1 and 2 locations where two or more enclosures are connected by 36" or less conduit. Seal must be located within 18" of either enclosure.
- Required where cables (which exceed rate of gas or vapor transmission permitted for seals) are used in Class I, Division 2 locations.

Features

- Explosionproof, dust-ignitionproof, raintight.
- Smooth, rounded integral bushing in each hub protects conductor insulation.
- Accurately tapped, tapered threads for tight, rigid joints and ground continuity.
- Removable nipple in male sealing fitting may be used interchangeably in top or bottom hub.
- EYS—for sealing vertical conduit. Large opening for damming and filling.
- Expanded fill EYSEF/EYDEF— allow up to 40% conduit fill in compliance with the National Electrical Code.
- EYSF/EYSM—for sealing vertical conduit. Large opening for damming and filling.
- ESUF/ESUM for sealing vertical or horizontal conduit. Pouring spout rotates 90°. Removable cover provides full access for damming 2-1/2" thru 4" sizes have threaded cover openings for damming.
- EYF/EYM—close radius type for sealing vertical or horizontal conduit runs.
- EYDM Drain Sealing Fittings—close radius type for sealing vertical conduit runs. Access cover has drain valve for automatic draining of water accumulation above the seal.
- UL Listed for use with Kwiko® A Sealing Compound. Also listed with certain competitors sealing cement, contact factory for details.

Standard Materials

- EYSF/EYSM, EYF/EYM and EYDM Seals: malleable iron or Almag 35 aluminum
- EYS, EYSEF/EYDEF, and ESUF/ESUM: malleable iron
- EYD and EYS Seals: Grayloy®-iron

Standard Finishes

- Malleable iron and Grayloy®-iron products have triple-coat — (1) zinc electroplate, (2) chromate, and (3) epoxy powder coat,
- Almag 35 aluminum products have epoxy powder coat

Certifications and Compliances

- UL Standard: 886 (1203)
- UL Listed: E10444
- CSA Standard: C22.2 No. 30
- CSA Certified: 065181

Options

- PVC coating available on select sealing fittings. Add suffix **-PVC** to catalog number.

Related Products

- Kwiko® A sealing cement and fiber filler

Illustrated Features

Sealing fittings prevent passage of gases, vapors or flames from one portion of a conduit system to another. They also restrict large amounts of ignitable gases or vapors from accumulating to confine explosive pressure.



Appleton sealing fittings are suitable for Class I and II locations. EYS, SF and EYD are for sealing vertical conduit. EY and ESU are for sealing vertical and horizontal conduit. SF and EYD also have drain valves.



EY 25% ^o Fill Vertical and Horizontal Conduit Sealing Fittings for Close Turning Radius









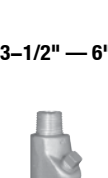

Explosionproof, Dust-Ignitionproof, Raintight

UNILETS[®] for Use with Threaded Rigid Metal Conduit and IMC.

Class I, Division 1 and 2 Groups A \diamond , B \blacklozenge , C, D
 Class II, Division 1 and 2 Groups E, F, G
 Class III

Fittings

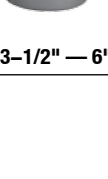
FITTINGS: HAZARDOUS SEALING FITTINGS

	Trade Size (Inches)	Inches/Millimeters			Kwiko [®] A Cement Required Ounces/Grams	Catalog Number	
		A (Length)	B (Width)	Turning Radius $\text{\textcircled{2}}$		Malleable Iron	Almag 35 Aluminum
Female							
	1/2	3.50/88.9	1.19/30.2	1.06/26.9	1.00/28.4	EYF-50 $\diamond \text{\textcircled{3}}$	EYF-50AL $\diamond \text{\textcircled{3}}$
	3/4	3.50/88.9	1.38/35.0	1.19/30.2	2.00/56.7	EYF-75 $\diamond \text{\textcircled{3}}$	EYF-75AL $\diamond \text{\textcircled{3}}$
	1	4.25/107.9	1.75/44.4	1.38/35.0	4.00/113.4	EYF-100 $\diamond \text{\textcircled{3}}$	EYF-100AL $\diamond \text{\textcircled{3}}$
	1-1/4	4.94/125.4	2.00/50.8	1.75/44.4	7.00/198.4	EYF-125 $\blacklozenge \text{\textcircled{3}}$	EYF-125AL $\text{\textcircled{3}}$
	1-1/2	5.50/139.7	2.38/60.4	2.06/52.3	13.00/368.5	EYF-150 $\blacklozenge \text{\textcircled{3}}$	EYF-150AL $\text{\textcircled{3}}$
	2	6.13/155.7	2.88/73.1	2.31/58.6	22.00/623.7	EYF-200 $\blacklozenge \text{\textcircled{3}}$	EYF-200AL $\text{\textcircled{3}}$
	2-1/2	7.50/190.5	3.38/85.8	2.69/68.3	36.00/1020.6	EYF-250 $\blacklozenge \text{\textcircled{3}}$	EYF-250AL $\text{\textcircled{3}}$
	3	8.13/206.5	4.13/104.9	3.13/79.5	61.00/1729.3	EYF-300 $\blacklozenge \text{\textcircled{3}}$	EYF-300AL $\text{\textcircled{3}}$
	3-1/2	8.94/227.0	4.75/120.6	3.44/87.3	89.00/2523.1	EYF-350 \blacklozenge	EYF-350AL
	4	9.38/238.2	5.13/130.3	3.69/93.7	114.00/3231.8	EYF-400 $\blacklozenge \text{\textcircled{3}}$	EYF-400AL $\text{\textcircled{3}}$
	5	10.81/274.5	6.25/158.7	4.69/119.1	202.00/5726.6	EYF-500 $\text{\textcircled{4}}$	—
	6	11.81/299.9	7.31/185.6	5.38/136.6	230.00/6520.4	EYF-600 $\text{\textcircled{4}}$	—
Male/Female (Removable Male Nipple)							
	1/2	3.50/88.9	1.19/30.2	1.06/26.9	1.00/28.4	EYM-50 $\diamond \text{\textcircled{3}}$	EYM-50AL $\diamond \text{\textcircled{3}}$
	3/4	3.50/88.9	1.38/35.0	1.19/30.2	2.00/56.7	EYM-75 $\diamond \text{\textcircled{3}}$	EYM-75AL $\diamond \text{\textcircled{3}}$
	1	4.25/107.9	1.75/44.4	1.38/35.0	4.00/113.4	EYM-100 $\diamond \text{\textcircled{3}}$	EYM-100AL $\diamond \text{\textcircled{3}}$
	1-1/4	4.94/125.4	2.00/50.8	1.75/44.4	7.00/198.4	EYM-125 $\blacklozenge \text{\textcircled{3}}$	EYM-125AL $\text{\textcircled{3}}$
	1-1/2	5.50/139.7	2.38/60.4	2.06/52.3	13.00/368.5	EYM-150 $\blacklozenge \text{\textcircled{3}}$	EYM-150AL $\text{\textcircled{3}}$
	2	6.13/155.7	2.88/73.1	2.31/58.6	22.00/623.7	EYM-200 $\blacklozenge \text{\textcircled{3}}$	EYM-200AL $\text{\textcircled{3}}$
	2-1/2	7.50/190.5	3.38/85.8	2.69/68.3	36.00/1020.6	EYM-250 $\blacklozenge \text{\textcircled{3}}$	EYM-250AL $\text{\textcircled{3}}$
	3	8.13/206.5	4.13/104.9	3.13/79.5	61.00/1729.3	EYM-300 $\blacklozenge \text{\textcircled{3}}$	EYM-300AL $\text{\textcircled{3}}$
	3-1/2	8.94/227.0	4.75/120.6	3.44/87.3	89.00/2523.1	EYM-350 \blacklozenge	EYM-350AL
	4	9.38/238.2	5.13/130.3	3.69/93.7	114.00/3231.8	EYM-400 $\blacklozenge \text{\textcircled{3}}$	EYM-400AL $\text{\textcircled{3}}$
	5	10.81/274.5	6.25/158.7	4.69/119.1	202.00/5726.6	EYM-500 $\text{\textcircled{4}}$	—
	6	11.81/299.9	7.31/185.6	5.38/136.6	230.00/6520.4	EYM-600 $\text{\textcircled{4}}$	—

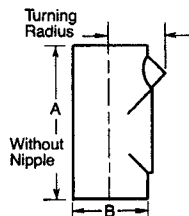

$\text{\textcircled{1}}$ Per NEC 501.15(C)(6), seals in Class I, Division 1 and 2 must be limited to conductor fill of 25% of cross sectional area of a rigid metal conduit of the same trade size unless approved for higher percentage fill. See 40% fill sealing fittings.

$\text{\textcircled{2}}$ Turning radius with cover or plug removed.

$\text{\textcircled{3}}$ PVC coating available on select sealing fittings. Add suffix -PVC to catalog number.

$\text{\textcircled{4}}$ Not UL Listed. CSA Certified only.

\diamond Indicates items in the shaded area which are UL Listed for Class I, Groups A, B, C, D; Class II, Groups E, F, G; and Class III.

\blacklozenge Indicated items in the shaded area which are UL Listed for Class I, Groups B, C, D; Class II, Groups E, F, G; and Class III.

Sealing Fittings

Explosionproof; Dust-Ignitionproof

UNILETS® for Use with Threaded Rigid Metal Conduit and IMC.

Applications

- Prevent passage of gases, vapors or flames from one portion of conduit system to another. Restrict any explosion to the sealed off enclosure. Prevent pressure piling within conduit system.
- Required in Class I, Division 1 and 2 locations within 18" of enclosures containing apparatus that may cause arcs, sparks or high temperatures.
- Required in Class I, Division 1 and 2 locations where 2" or larger conduit enters enclosure, fitting housing terminals, splices or taps.
- Required in Class I, Division 1 and 2 locations at the boundary where conduit leaves classified location.
- Required in Class I, Division 1 and 2 locations where two or more enclosures are connected by 36" or less conduit. Seal must be located within 18" of either enclosure.
- Required where cables (which exceed rate of gas or vapor transmission permitted for seals) are used in Class I, Division 2 locations.

Features

- Explosionproof, dust-ignitionproof, raintight.
- Smooth, rounded integral bushing in each hub protects conductor insulation.
- Accurately tapped, tapered threads for tight, rigid joints and ground continuity.
- Removable nipple in male sealing fitting may be used interchangeably in top or bottom hub.
- EYS—for sealing vertical conduit. Large opening for damming and filling.
- Expanded fill EYSEF/EYDEF— allow up to 40% conduit fill in compliance with the National Electrical Code.
- EYSF/EYSM—for sealing vertical conduit. Large opening for damming and filling.
- ESUF/ESUM for sealing vertical or horizontal conduit. Pouring spout rotates 90°. Removable cover provides full access for damming 2-1/2" thru 4" sizes have threaded cover openings for damming.
- EYF/EYM—close radius type for sealing vertical or horizontal conduit runs.
- EYDM Drain Sealing Fittings—close radius type for sealing vertical conduit runs. Access cover has drain valve for automatic draining of water accumulation above the seal.
- UL Listed for use with Kwiko® A Sealing Compound. Also listed with certain competitors sealing cement, contact factory for details.

Standard Materials

- EYSF/EYSM, EYF/EYM and EYDM Seals: malleable iron or Almag 35 aluminum
- EYS, EYSEF/EYDEF, and ESUF/ESUM: malleable iron
- EYD and EYS Seals: Grayloy®-iron

Standard Finishes

- Malleable iron and Grayloy®-iron products have triple-coat — (1) zinc electroplate, (2) chromate, and (3) epoxy powder coat,
- Almag 35 aluminum products have epoxy powder coat

Certifications and Compliances

- UL Standard: 886 (1203)
- UL Listed: E10444
- CSA Standard: C22.2 No. 30
- CSA Certified: 065181

Options

- PVC coating available on select sealing fittings. Add suffix **-PVC** to catalog number.

Related Products

- Kwiko® A sealing cement and fiber filler

Illustrated Features

Sealing fittings prevent passage of gases, vapors or flames from one portion of a conduit system to another. They also restrict large amounts of ignitable gases or vapors from accumulating to confine explosive pressure.



Appleton sealing fittings are suitable for Class I and II locations. EYS, SF and EYD are for sealing vertical conduit. EY and ESU are for sealing vertical and horizontal conduit. SF and EYD also have drain valves.



EY 25% ^o Fill Vertical and Horizontal Conduit Sealing Fittings for Close Turning Radius













Explosionproof, Dust-Ignitionproof, Raintight

UNILETS[®] for Use with Threaded Rigid Metal Conduit and IMC.

Class I, Division 1 and 2 Groups A \diamond , B \blacklozenge , C, D
 Class II, Division 1 and 2 Groups E, F, G
 Class III

Fittings

FITTINGS: HAZARDOUS SEALING FITTINGS

	Trade Size (Inches)	Inches/Millimeters			Kwiko [®] A Cement Required Ounces/Grams	Catalog Number	
		A (Length)	B (Width)	Turning Radius $\text{\textcircled{2}}$		Malleable Iron	Almag 35 Aluminum
Female							
	1/2	3.50/88.9	1.19/30.2	1.06/26.9	1.00/28.4	EYF-50 \diamond $\text{\textcircled{3}}$	EYF-50AL \diamond $\text{\textcircled{3}}$
	3/4	3.50/88.9	1.38/35.0	1.19/30.2	2.00/56.7	EYF-75 \diamond $\text{\textcircled{3}}$	EYF-75AL \diamond $\text{\textcircled{3}}$
	1	4.25/107.9	1.75/44.4	1.38/35.0	4.00/113.4	EYF-100 \diamond $\text{\textcircled{3}}$	EYF-100AL \diamond $\text{\textcircled{3}}$
	1-1/4	4.94/125.4	2.00/50.8	1.75/44.4	7.00/198.4	EYF-125 \blacklozenge $\text{\textcircled{3}}$	EYF-125AL $\text{\textcircled{3}}$
	1-1/2	5.50/139.7	2.38/60.4	2.06/52.3	13.00/368.5	EYF-150 \blacklozenge $\text{\textcircled{3}}$	EYF-150AL $\text{\textcircled{3}}$
	2	6.13/155.7	2.88/73.1	2.31/58.6	22.00/623.7	EYF-200 \blacklozenge $\text{\textcircled{3}}$	EYF-200AL $\text{\textcircled{3}}$
	2-1/2	7.50/190.5	3.38/85.8	2.69/68.3	36.00/1020.6	EYF-250 \blacklozenge $\text{\textcircled{3}}$	EYF-250AL $\text{\textcircled{3}}$
	3	8.13/206.5	4.13/104.9	3.13/79.5	61.00/1729.3	EYF-300 \blacklozenge $\text{\textcircled{3}}$	EYF-300AL $\text{\textcircled{3}}$
	3-1/2	8.94/227.0	4.75/120.6	3.44/87.3	89.00/2523.1	EYF-350 \blacklozenge	EYF-350AL
	4	9.38/238.2	5.13/130.3	3.69/93.7	114.00/3231.8	EYF-400 \blacklozenge $\text{\textcircled{3}}$	EYF-400AL $\text{\textcircled{3}}$
	5	10.81/274.5	6.25/158.7	4.69/119.1	202.00/5726.6	EYF-500 $\text{\textcircled{4}}$	—
	6	11.81/299.9	7.31/185.6	5.38/136.6	230.00/6520.4	EYF-600 $\text{\textcircled{4}}$	—
Male/Female (Removable Male Nipple)							
	1/2	3.50/88.9	1.19/30.2	1.06/26.9	1.00/28.4	EYM-50 \diamond $\text{\textcircled{3}}$	EYM-50AL \diamond $\text{\textcircled{3}}$
	3/4	3.50/88.9	1.38/35.0	1.19/30.2	2.00/56.7	EYM-75 \diamond $\text{\textcircled{3}}$	EYM-75AL \diamond $\text{\textcircled{3}}$
	1	4.25/107.9	1.75/44.4	1.38/35.0	4.00/113.4	EYM-100 \diamond $\text{\textcircled{3}}$	EYM-100AL \diamond $\text{\textcircled{3}}$
	1-1/4	4.94/125.4	2.00/50.8	1.75/44.4	7.00/198.4	EYM-125 \blacklozenge $\text{\textcircled{3}}$	EYM-125AL $\text{\textcircled{3}}$
	1-1/2	5.50/139.7	2.38/60.4	2.06/52.3	13.00/368.5	EYM-150 \blacklozenge $\text{\textcircled{3}}$	EYM-150AL $\text{\textcircled{3}}$
	2	6.13/155.7	2.88/73.1	2.31/58.6	22.00/623.7	EYM-200 \blacklozenge $\text{\textcircled{3}}$	EYM-200AL $\text{\textcircled{3}}$
	2-1/2	7.50/190.5	3.38/85.8	2.69/68.3	36.00/1020.6	EYM-250 \blacklozenge $\text{\textcircled{3}}$	EYM-250AL $\text{\textcircled{3}}$
	3	8.13/206.5	4.13/104.9	3.13/79.5	61.00/1729.3	EYM-300 \blacklozenge $\text{\textcircled{3}}$	EYM-300AL $\text{\textcircled{3}}$
	3-1/2	8.94/227.0	4.75/120.6	3.44/87.3	89.00/2523.1	EYM-350 \blacklozenge	EYM-350AL
	4	9.38/238.2	5.13/130.3	3.69/93.7	114.00/3231.8	EYM-400 \blacklozenge $\text{\textcircled{3}}$	EYM-400AL $\text{\textcircled{3}}$
	5	10.81/274.5	6.25/158.7	4.69/119.1	202.00/5726.6	EYM-500 $\text{\textcircled{4}}$	—
	6	11.81/299.9	7.31/185.6	5.38/136.6	230.00/6520.4	EYM-600 $\text{\textcircled{4}}$	—

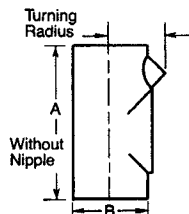

$\text{\textcircled{1}}$ Per NEC 501.15(C)(6), seals in Class I, Division 1 and 2 must be limited to conductor fill of 25% of cross sectional area of a rigid metal conduit of the same trade size unless approved for higher percentage fill. See 40% fill sealing fittings.

$\text{\textcircled{2}}$ Turning radius with cover or plug removed.

$\text{\textcircled{3}}$ PVC coating available on select sealing fittings. Add suffix -PVC to catalog number.

$\text{\textcircled{4}}$ Not UL Listed. CSA Certified only.

\diamond Indicates items in the shaded area which are UL Listed for Class I, Groups A, B, C, D; Class II, Groups E, F, G; and Class III.

\blacklozenge Indicated items in the shaded area which are UL Listed for Class I, Groups B, C, D; Class II, Groups E, F, G; and Class III.