

## Hazardous Location Fittings

### EYD Drain Seals

Cl. I, Div. 1 & 2, Groups A, B, C, D

Cl. II, Div. 1, Groups E, F, G

Cl. III, Div. 1 & 2

#### Application

**EYD drain and inspection sealing fittings:**

- Restrict the passage of gases, vapors or flames from one portion of the electrical installation to another at atmospheric pressure and normal ambient temperatures
- Limit explosions to the sealed-off enclosure
- Prevent precompression or “pressure piling” in conduit systems. Drain sealing fittings are installed in vertical conduit runs and at low points in conduit systems to prevent accumulation of condensate above seal

#### Features

**EYD drain sealing fittings include:**

- Drain to provide continuous, automatic drainage of condensate
- Large openings with threaded closures to provide easy access to conduit hubs for making dams
- Integral bushings to protect conductor insulation from damage
- Tapered-tapped hubs to ensure ground continuity

#### Standard Materials

Bodies and drain covers — Gray iron alloy and/or ductile iron

Closure for drain — copper-free aluminum or ductile iron

Small closure plug — Gray iron alloy and/or steel

Drain — stainless steel

Removable nipples — steel

#### Standard Finish

Gray iron alloy and ductile iron — electrogalvanized and aluminum acrylic paint

Copper-free aluminum — natural

Stainless steel — natural

Steel — electrogalvanized

#### Options

Copper-free aluminum bodies, nipples and enclosures — see listings



#### Size Ranges

EYD — ½"–4"

#### Listings/Compliances

EYD11 — 31-TB

Class I, Division 1 & 2, Groups A, B, C, D; Class II, Division 1, Groups E, F, G; Class III

EYD41 — 101-TB

Class I, Division 1 & 2, Groups C, D; Class II, Division 1, Groups E, F, G; Class II, Division 2, Groups F, G

Class III

UL Standard: 886

CSA Standard: C22.2

NEMA 3, 4, 7 CD, 9 EFG

Explosion-Proof

Dust-Ignition-Proof

Raintight

Wet Locations

#### Sealing Compound and Fibers

Seal A3 (1-lb. can of sealing compound)

Fiber X6 (8-oz. fiber packing)

Seal Kit (1-lb. can of sealing compound and 1-oz. fiber packing)

## Hazardous Location Fittings

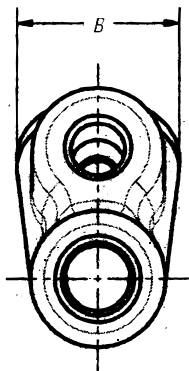

EYD 1/2" - 1"

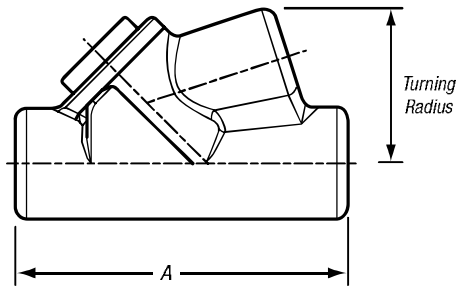

EYD 1/2" - 1"

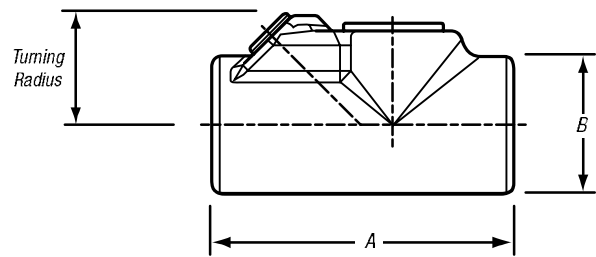

EYD 1 1/4" - 4"



### EYD Drain Seals

CAT. NO.	HUB SIZE	DIMENSIONS (IN.)		TURNING RADIUS
		A	B	
EYD11-TB	1/2"	3.81	1.50	1.75
EYD21-TB	3/4"	4.08	1.75	1.98
EYD31-TB	1"	4.85	2.19	2.19
EYD41-TB	1 1/4"	5.00	2.25	1.80
EYD51-TB	1 1/2"	5.44	2.44	2.00
EYD61-TB	2"	6.25	3.00	2.32
EYD71-TB	2 1/2"	7.50	3.50	2.69
EYD81-TB	3"	8.50	4.25	3.15
EYD91-TB	3 1/2"	9.19	4.75	3.38
EYD101-TB	4"	9.75	5.25	3.64

## Drains/Breathers for Hazardous Locations

### Application

The Thomas & Betts Universal drain/breather fittings can be used as drains or breathers depending on the installation.

- To use as a drain, the product must be installed in the bottom of the enclosure or the lowest point where an NPT threaded opening exists. It can also be used in a seal fitting or a "T" conduit body. These must be in a lower section of the conduit system. This will enable moisture inside the conduit system to drain out
- To use as a breather, installation should be done at the top of an enclosure or in upper sections of conduit systems. This will permit air exchange and keep moisture accumulation inside the conduit system to a minimum. Thomas & Betts recommends the use of at least two devices (one drain and one breather) for maximum efficiency



CAT. NO.	HUB SIZE	DIMENSIONS (IN.)
		B
ECD15	1/2"	.975
ECD384	3/8"	.407
ECD284	1/4"	.327

## Hazardous Location Fittings

### EYS Sealing Fittings

#### Application

EYS sealing fittings can be installed in either vertical or horizontal applications.

- Seals sections of conduit runs from passage of vapors, flame, or gases
- Seals off sections of conduit system during explosion
- Limits precompression or pressure piling in conduit system

#### Features

- All hubs have a minimum of five full threads, integral bushings to protect conductor insulation from damage and large access openings for easier packing of sealing medium
- Seals are approved to be used with Crouse-Hinds® Sealing Compound and Fiber

#### Size Range

½" NPT to 4" NPT

#### Materials

Bodies: Ductile Iron  
 Plugs: Gray Iron  
 Nipples: Steel, supplied with EYS fittings

#### Finish

Bodies: Zinc-plated with aluminum acrylic paint  
 Plugs: Zinc-plated with aluminum acrylic paint  
 Nipples: Zinc-plated

#### Sealing Compound and Fibers

Seal A3 (1-lb. can of sealing compound)  
 Fiber X6 (8-oz. fiber packing)  
 Sealkit (1-lb. can of sealing compound and 1-oz. fiber packing)

#### Listings/Compliances

UL886  
 CSA: C22.2 No. 30  
 EYS seals are approved to be used with Crouse-Hinds® Chico® A compound and Chico® X fiber  
 EYS1-3TB:  
 Cl. I, Div. 1 & 2, Groups A, B, C, D  
 EYS4-5TB:  
 Cl. I, Div. 1 & 2, Groups C, D  
 EYS11-31TB:  
 Cl. I, Div. 1 & 2, Groups A, B, C, D  
 Cl. II, Div. 1, Groups E, F, G  
 Cl. III

EYS41-101TB:  
 Cl. I, Div. 1 & 2, Groups C, D  
 Cl. II, Div. 1, Groups E, F, G  
 Cl. III  
 Explosion-Proof  
 Dust-Ignition-Proof

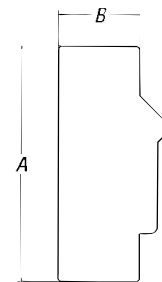

EYS11-TB – EYS101-TB



CAT. NO.	HUB SIZE	DIMENSIONS (IN.)			TURNING RADIUS
		A	B	C	
<b>Vertical Only</b>					
EYS1-TB	½"	3.31	1.25	1.50	1.66"
EYS2-TB	¾"	3.65	1.50	1.75	1.96"
EYS3-TB	1"	4.25	1.75	2.19	2.40"
EYS4-TB	1¼"	5.00	2.25	2.45	3.11"
EYS5-TB	1½"	5.69	2.45	3.00	3.62"
<b>Horizontal/Vertical</b>					
EYS11-TB	½"	3⅞	1¼	—	1⅜"
EYS21-TB	¾"	3⅝	1½	—	1¼"
EYS31-TB	1"	4¼	1¾	—	1⅞
EYS41-TB	1¼"	5	2¼	—	1⅞
EYS51-TB	1½"	5⅞	2⅞	—	2"
EYS61-TB	2"	6¼	3	—	2⅞
EYS71-TB	2½"	7½	3½	—	2⅞
EYS81-TB	3"	8½	4¼	—	3⅝
EYS91-TB	3½"	9⅞	4¾	—	3⅞
EYS101-TB	4"	9¼	5¼	—	3⅞

Crouse-Hinds® and Chico® are trademarks of Cooper Industries, Inc.

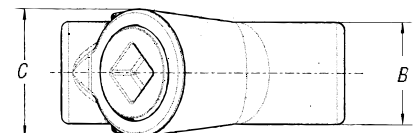
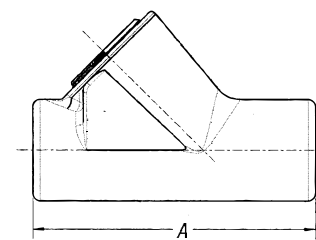

EYS1-TB – EYS5-TB

## Hazardous Location Fittings

### EYVF and EVHF Sealing Fittings

#### Application

- Limits flames and/or explosions to area within electrical system where they originate
- Limits pressure piling
- Required by NEC® for conduit systems in hazardous locations 18" from an enclosure housing a heat producing or arcing device; on 2" and larger system that enters an enclosure containing splices; wherever conduit leaves a Class I, Division I area and enters a non-hazardous area

#### Features

- Copper-free\* aluminum provides increased corrosion resistance
- Precision cast and machined surfaces permit safer wire pulling
- Precision NPT threaded hubs enable trouble-free field installation for rigid or IMC conduit
- Large opening provides maximum working room for creating dam and seal pouring to speed up installation
- Compact design permits close construction of parallel conduit runs

#### Standard Materials

Sealing Fittings: Die-cast aluminum alloy A360 with less than .004 copper content (copper-free)  
 Sealing Cement  
 Fiber: Flame-retardant Kaowool Type A fiber

#### Standard Finish

Aluminum lacquer finish

#### Listings/Compliances

UL Listed  
 CSA Certified  
 Suitable for hazardous locations  
 Federal Spec W-C-586  
 Cl. I, Div. 1 & 2, Groups C, D  
 Cl. II, Div. 1, Groups E, F, G  
 Cl. III, Div. 1 & 2  
 NEMA 3, 4, 7 CD, 9 EFG  
 Explosion-Proof  
 Dust-Ignition-Proof  
 Raintight  
 Wet Locations

#### Sample Specifications

Sealing fittings for hazardous locations shall be die-cast copper-free\* aluminum alloy A360. Suitable for use in hazardous locations: Class I, Groups C, D; Class II, Groups E, F, G and Class III. All conduit stops shall be coined and free of rough edges. Sealing fittings for hazardous locations shall be finished with aluminum lacquer. Sealing fittings shall be Thomas & Betts Catalog No. \_\_\_\_\_

\*Less than .004% copper content.

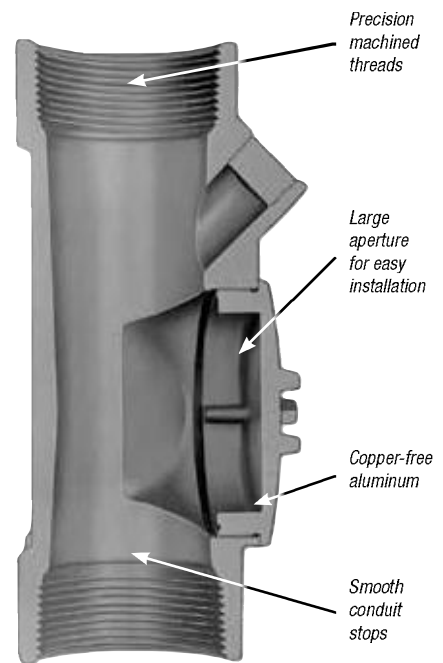

Conduit & Fittings — T&B® Rigid Fittings



EYVF



EVHF-1 through -3



EVHF-4 through -9

#### Vertical Sealing Fittings



CAT. NO.	HUB SIZE	UNIT QTY.	STD. PKG.	WT. LBS. PER 100
EYVF-1†	½"	5	25	50
EYVF-2†	¾"	5	25	54
EYVF-3†	1"	5	25	100
EYVF-11	½"	10	50	35
EYVF-22	¾"	10	50	40
EYVF-33	1"	4	20	60

#### Vertical/Horizontal Sealing Fittings



CAT. NO.	HUB SIZE	UNIT QTY.	STD. PKG.	WT. LBS. PER 100
EVHF-1	½"	10	50	41
EVHF-2	¾"	5	25	50
EVHF-3	1"	5	25	60
EVHF-4	1¼"	4	20	70
EVHF-5	1½"	1	5	60
EVHF-6	2"	1	1	125
EVHF-7 •	2½"	1	1	150
EVHF-9 •	3½"	1	1	300

• Made-to-order items. Consult factory for lead time and minimum quantities.

† Packaged with an adequate amount of sealing compound and plugs installed.