

# 6" LED / PAR LED / INCANDESCENT EZ SERIES IC AIR-SHUT HOUSING

## EZ6IC-AT 6" UNIVERSAL IC HOUSING WITH LOOSE SOCKET AND QUICK CONNECTORS

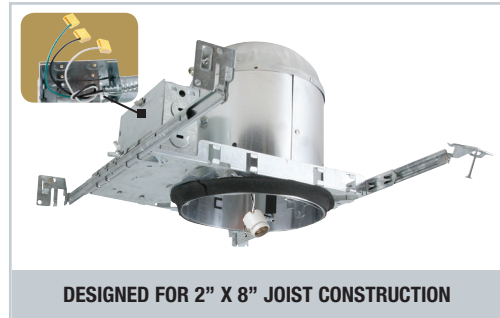

DESIGNED FOR 2" X 8" JOIST CONSTRUCTION

### DESCRIPTION

For new construction. Thermally protected, IC rated specification grade recessed housing. Accommodates up to 75W PAR30, R30 lamps, 60W A19 lamps, 65W BR30 lamps, up to 12W LED PAR30 lamps and RL series LED retrofit module.

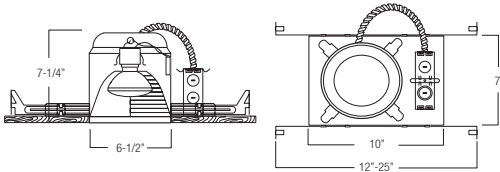

### SPECIFICATION

**A. HOUSING** - Die-formed all aluminum construction for maximum heat dissipation and rust protection. Adjusts vertically in plaster frame to accommodate 1/2" to 1-3/8" ceiling.

**B. SOCKET** - Medium base screw shell porcelain socket that attaches directly to the AF series trims.

**C. BAR HANGERS** - Preinstalled bar hangers allow housing to be positioned and locked at any point within a 24" joist span. They can be positioned on either the long or short axis of the housing and can be shortened for 12" joists. They contain a double-headed real nail for secure attachment into the joist. Bar hanger nails are installed on a 20° downward angle for better contact, and the 90° pivoting mounting plate makes installation fast and accurate. Bar hangers can fit onto T-Bar spline with additional slots and holes for special mounting methods if necessary.

**D. JUNCTION BOX** - UL listed for through-branch circuit wiring and has four 1/2" KOs, one 3/4" KO and four Romex knockouts with true pry-out slots and strain clamps. With quick-connectors included.

**E. THERMAL PROTECTION** - Standard thermal protection device guards against improper installation, overlamping and misuse of insulation material.

### UL and C-UL listed

For Damp location  
For Feed-through wiring  
For Direct contact with insulation

### OPTION

#### 1. AIR-SHUT-

- Gasket to prevent air flow from heated or air conditioned spaces.

- Meets all national air flow requirements.



### TYPE

EZ6IC-AT

USABLE WITH RL6 SERIES  
LED RETROFIT MODULE

## EZ6RIC-AT 6" UNIVERSAL IC REMODEL HOUSING WITH LOOSE SOCKET AND QUICK CONNECTORS

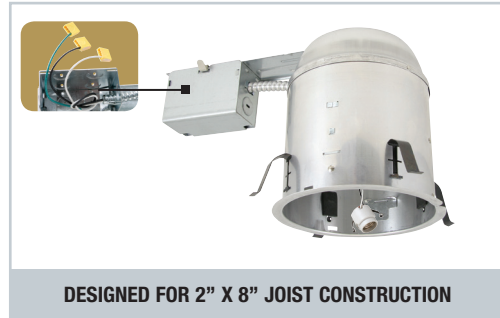

DESIGNED FOR 2" X 8" JOIST CONSTRUCTION

### DESCRIPTION

Thermally protected, IC rated specification grade remodel recessed housing. For remodeling installations where housing will be in direct contact with insulation. Accommodates up to 75W PAR30, R30 lamps, 60W A19 lamps, 65W BR30 lamp, up to 12W LED PAR30 lamps and RL series LED retrofit module.

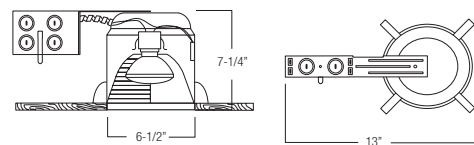

### SPECIFICATION

**A. HOUSING** - Die-formed, all aluminum construction for maximum heat dissipation and rust protection.

**B. SOCKET** - Medium base screw shell porcelain socket that attaches directly to the AF series trims.

**C. INSTALLATION** - For fast and easy installation in existing plaster or mechanical ceilings from 1/2" to 1-3/8" thick. Four remodel clips are easily retractable for fixture removal if necessary.

**D. JUNCTION BOX** - UL listed for through-branch circuit wiring, provided with eight 1/2" KOs and four Romex knockouts with strain relief. With quick-connectors included.

**E. THERMAL PROTECTION** - Standard thermal protection device guards against improper installation, overlamping and misuse of insulation material.

### UL and C-UL listed

For Damp location  
For Feed-through wiring  
For Direct contact with insulation

### OPTION

#### 1. AIR-SHUT-

- Gasket to prevent air flow from heated or air conditioned spaces.

- Meets all national air flow requirements.



USABLE WITH RL6 SERIES  
LED RETROFIT MODULE



**LED PAR30, 10-12W**  
Equivalent to 65W CFL Lamp  
is compatible with the series on this page.



6"

6 INCH LED / PAR LED / INCANDESCENT EZ SERIES IC HOUSING

# 6" EZ SERIES Incandescent Trims

(LAMP WATTAGE: (1) MAXIMUM 75W R/PAR30, 60W A19, 65W BR30)

Catalog Number:

Project Name:

Type:

Note:



**AF631W-WH (SOCKET SUPPORTING)  
R30/PAR30 SELF FLANGE AIR-SHUT BAFFLE**



AVAILABLE COLOR COMBINATIONS:  
W-WH, P-WH, P-BK, SN-SN, CP-CP, BZ-BZ

NEW CLIP DESIGN

**AF649W-WH (SOCKET SUPPORTING)  
R40/PAR38 DEEP SELF FLANGE AIR-SHUT BAFFLE**



AVAILABLE COLOR COMBINATIONS:  
W-WH, P-WH

NEW CLIP DESIGN

**AF630W-0V (SOCKET SUPPORTING)  
R30/PAR30 AIR-SHUT BAFFLE W/ OVER-SIZED RING**



AVAILABLE COLOR COMBINATIONS:  
W-WH, P-WH

NEW CLIP DESIGN

**AF651W (SOCKET SUPPORTING)  
R30/PAR30 CONE OPEN TRIM**



AVAILABLE COLOR:  
WHITE ONLY

NEW CLIP DESIGN

**AF637W-WH (SOCKET SUPPORTING)  
SELF FLANGE AIR-SHUT BAFFLE**



AVAILABLE COLOR COMBINATIONS:  
W-WH, P-WH, P-BK, SN-SN, CP-CP, BZ-BZ

NEW CLIP DESIGN

**AF640W-WH (SOCKET SUPPORTING)  
DEEP SELF FLANGE AIR-SHUT BAFFLE**



AVAILABLE COLOR COMBINATIONS:  
W-WH, P-WH, SN-SN, CP-CP, BZ-BZ

NEW CLIP DESIGN

**AF634W-CL-WH (SOCKET SUPPORTING)  
R30/PAR30 AIR-SHUT REFLECTOR W/ BAFFLE**



AVAILABLE COLORS:  
W-CL-WH, P-CL-WH

NEW CLIP DESIGN

**AF632RG-WH (SOCKET SUPPORTING)  
R30/PAR30 AIR-SHUT REFLECTOR**

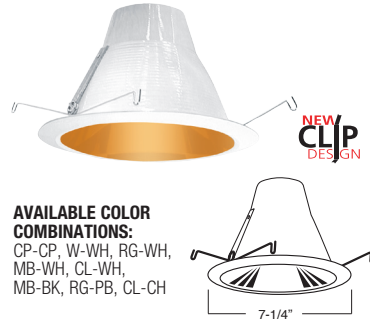

AVAILABLE COLOR COMBINATIONS:  
CP-CP, W-WH, RG-WH, MB-WH, CL-WH, MB-BK, RG-PB, CL-CH

NEW CLIP DESIGN

**AF639W-WH (SOCKET SUPPORTING)  
SELF FLANGE AIR-SHUT BAFFLE**



AVAILABLE COLOR COMBINATIONS:  
W-WH

NEW CLIP DESIGN

MATT WHITE FINISH

**AF644W-WH (SOCKET SUPPORTING)  
PAR30 OPEN RATED SHOWER TRIM**



AVAILABLE COLOR COMBINATIONS:  
W-WH, P-WH, P-BK, SN-SN, CP-CP, BZ-BZ

FOR WET LOCATION

NEW

**AF601CP (SOCKET SUPPORTING)  
METAL ALBALITE SHOWER TRIM**

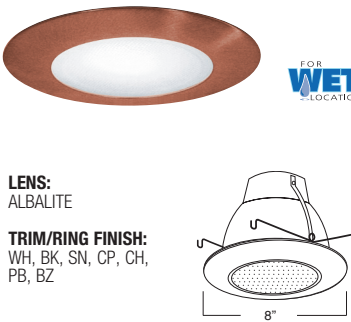

LENS:  
ALBALITE

TRIM/RING FINISH:  
WH, BK, SN, CP, CH, PB, BZ

FOR WET LOCATION

**AF605PB (SOCKET SUPPORTING)  
METAL FRESNEL SHOWER TRIM**

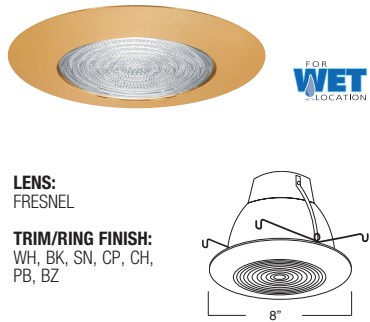

LENS:  
FRESNEL

TRIM/RING FINISH:  
WH, BK, SN, CP, CH, PB, BZ

FOR WET LOCATION

**AF606CP (SOCKET SUPPORTING)  
METAL DROP OPAL SHOWER TRIM**

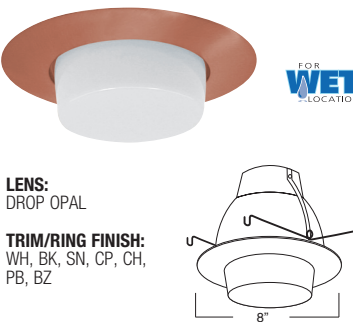

LENS:  
DROP OPAL

TRIM/RING FINISH:  
WH, BK, SN, CP, CH, PB, BZ

FOR WET LOCATION

**AF636W-WH (SOCKET SUPPORTING)  
BAFFLE W/ FRESNEL LENS**

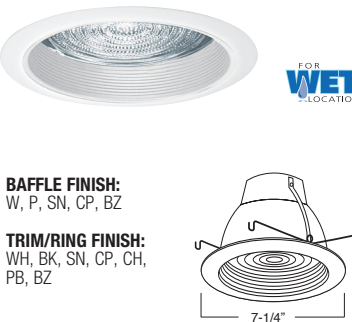

BAFFLE FINISH:  
W, P, SN, CP, BZ

TRIM/RING FINISH:  
WH, BK, SN, CP, CH, PB, BZ

FOR WET LOCATION

**AF635P-WH (SOCKET SUPPORTING)  
BAFFLE W/ ALBALITE LENS**

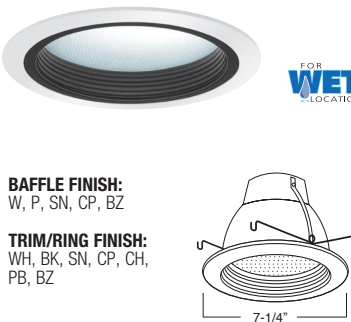

BAFFLE FINISH:  
W, P, SN, CP, BZ

TRIM/RING FINISH:  
WH, BK, SN, CP, CH, PB, BZ

FOR WET LOCATION

**AF642CL-WH (SOCKET SUPPORTING)  
REFLECTOR W/ FRESNEL LENS**

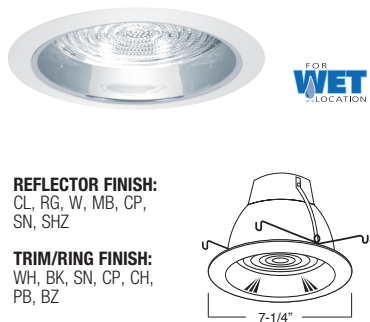

REFLECTOR FINISH:  
CL, RG, W, MB, CP, SN, SHZ

TRIM/RING FINISH:  
WH, BK, SN, CP, CH, PB, BZ

FOR WET LOCATION

# 6" EZ SERIES Incandescent Trims

( LAMP WATTAGE: (1) MAXIMUM 75W R/PAR30, 60W A19, 65W BR30)

Catalog Number:

Project Name:

Type:

Note:



**AF641RG-WH (SOCKET SUPPORTING)  
REFLECTOR W/ ALBALITE LENS**



**REFLECTOR FINISH:**  
CL, RG, W, MB, CP,  
SN, SHZ

**TRIM/RING FINISH:**  
WH, BK, SN, CP, CH,  
PB, BZ

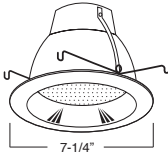

7-1/4"

**AF643RG-WH (SOCKET SUPPORTING)  
REFLECTOR W/ DROP OPAL LENS**



**REFLECTOR FINISH:**  
CL, RG, W, MB, CP,  
SN, SHZ

**TRIM/RING FINISH:**  
WH, BK, SN, CP, CH,  
PB, BZ

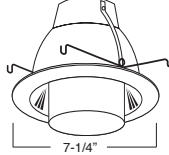

7-1/4"

**AF638W-WH (SOCKET SUPPORTING)  
BAFFLE W/ DROP OPAL LENS**



**BAFFLE FINISH:**  
W, P, SN, CP, BZ

**TRIM/RING FINISH:**  
WH, BK, SN, CP, CH,  
PB, BZ

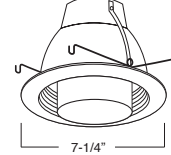

7-1/4"

**AF601L (SOCKET SUPPORTING)  
PLASTIC ALBALITE SHOWER TRIM**



**LENS:**  
ALBALITE

**TRIM/RING FINISH:**  
WHITE PLASTIC

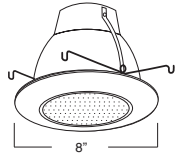

8"

**AF605L (SOCKET SUPPORTING)  
PLASTIC FRESNEL SHOWER TRIM**



**LENS:**  
FRESNEL

**TRIM/RING FINISH:**  
WHITE PLASTIC

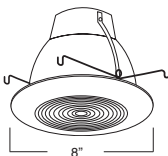

8"

**AF606L (SOCKET SUPPORTING)  
PLASTIC DROP OPAL SHOWER TRIM**



**LENS:**  
DROP OPAL

**TRIM/RING FINISH:**  
WHITE PLASTIC

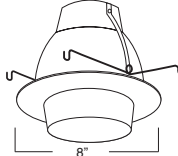

8"

**AF633CP  
SOCKET SUPPORTING R/PAR30 OPEN TRIM**

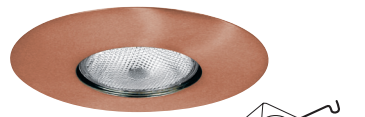

**TRIM/RING FINISH:**  
WH, BK, SN, CP, CH,  
PB, BZ

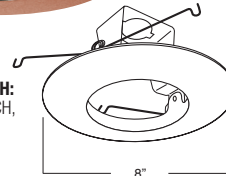

8"

**B602SN  
EYEBALL**



**TRIM/RING FINISH:**  
WH, BK, SN, CP, CH,  
PB, BZ

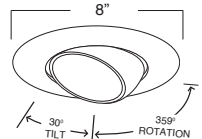

8"

**B609W-WH  
REGRESSED EYEBALL WITH BAFFLE**



**BAFFLE FINISH:**  
W, P, SN, CP, BZ

**TRIM/RING FINISH:**  
WH, BK, SN, CP, CH,  
PB, BZ

**EYEBALL FINISH:**  
WH, BK, SN, CP, CH, PB, BZ

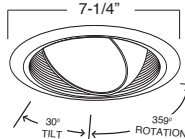

7-1/4"

**B663PB  
PAR30 GIMBAL RING**

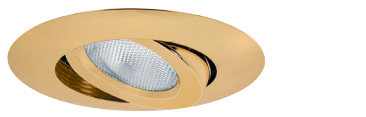

**TRIM/RING FINISH:**  
WH, BK, SN, CP, CH,  
PB, BZ

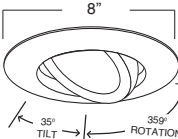

8"

**B673W-WH  
PAR30 BAFFLE W/ GIMBAL RING**



**BAFFLE FINISH:**  
W, P, SN, CP, BZ

**TRIM/RING FINISH:**  
WH, BK, SN, CP, CH,  
PB, BZ

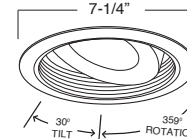

7-1/4"

BAFFLE		REFLECTOR		TRIM RING	
<b>W</b>	White	<b>CL</b>	Chrome	<b>WH</b>	White
<b>P</b>	Black	<b>RG</b>	Gold	<b>BK</b>	Black
<b>SN</b>	Satin Nickel	<b>W</b>	White	<b>SN</b>	Satin Nickel
<b>CP</b>	Copper	<b>MB</b>	Black	<b>CP</b>	Copper
<b>BZ</b>	Bronze	<b>CP</b>	Copper	<b>CH</b>	Chrome
		<b>SN</b>	Satin Nickel	<b>PB</b>	Polish Brass
				<b>BZ</b>	Bronze

\*For custom baffle, reflector, trim ring, glass color and lens options, please consult factory.

# 6" LED / PAR LED / INCANDESCENT EZ SERIES IC AIR-SHUT HOUSING

## EZ6IC-AT

6" UNIVERSAL IC HOUSING WITH LOOSE SOCKET AND QUICK CONNECTORS

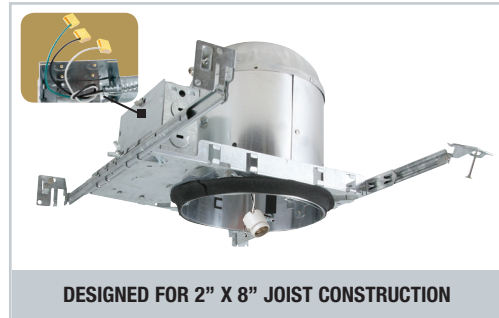

DESIGNED FOR 2" X 8" JOIST CONSTRUCTION

### DESCRIPTION

For new construction. Thermally protected, IC rated specification grade recessed housing. Accommodates up to 75W PAR30, R30 lamps, 60W A19 lamps, 65W BR30 lamps, up to 12W LED PAR30 lamps and RL series LED retrofit module.

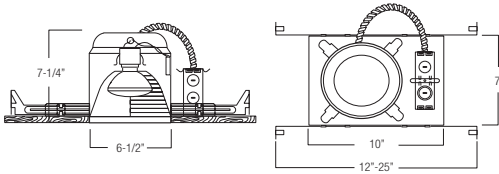

### SPECIFICATION

**A. HOUSING** - Die-formed all aluminum construction for maximum heat dissipation and rust protection. Adjusts vertically in plaster frame to accommodate 1/2" to 1-3/8" ceiling.

**B. SOCKET** - Medium base screw shell porcelain socket that attaches directly to the AF series trims.

**C. BAR HANGERS** - Preinstalled bar hangers allow housing to be positioned and locked at any point within a 24" joist span. They can be positioned on either the long or short axis of the housing and can be shortened for 12" joists. They contain a double-headed real nail for secure attachment into the joist. Bar hanger nails are installed on a 20° downward angle for better contact, and the 90° pivoting mounting plate makes installation fast and accurate. Bar hangers can fit onto T-Bar spline with additional slots and holes for special mounting methods if necessary.

**D. JUNCTION BOX** - UL listed for through-branch circuit wiring and has four 1/2" KOs, one 3/4" KO and four Romex knockouts with true pry-out slots and strain clamps. With quick-connectors included.

**E. THERMAL PROTECTION** - Standard thermal protection device guards against improper installation, overlamping and misuse of insulation material.

### UL and C-UL listed

For Damp location  
For Feed-through wiring  
For Direct contact with insulation

### OPTION

#### 1. AIR-SHUT-

- Gasket to prevent air flow from heated or air conditioned spaces.

- Meets all national air flow requirements.



TYPE
<input type="checkbox"/> EZ6IC-AT

USABLE WITH RL6 SERIES LED RETROFIT MODULE



## EZ6RIC-AT

6" UNIVERSAL IC REMODEL HOUSING WITH LOOSE SOCKET AND QUICK CONNECTORS

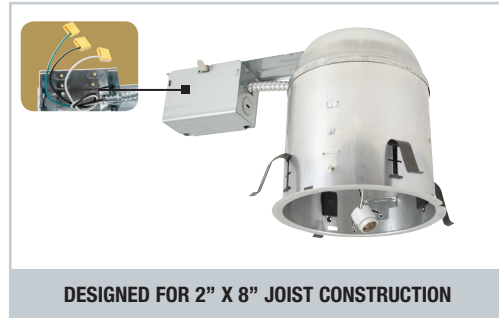

DESIGNED FOR 2" X 8" JOIST CONSTRUCTION

### DESCRIPTION

Thermally protected, IC rated specification grade remodel recessed housing. For remodeling installations where housing will be in direct contact with insulation. Accommodates up to 75W PAR30, R30 lamps, 60W A19 lamps, 65W BR30 lamp, up to 12W LED PAR30 lamps and RL series LED retrofit module.

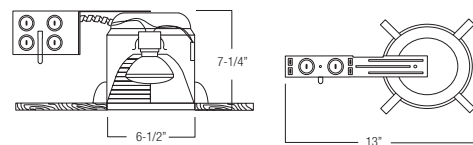

### SPECIFICATION

**A. HOUSING** - Die-formed, all aluminum construction for maximum heat dissipation and rust protection.

**B. SOCKET** - Medium base screw shell porcelain socket that attaches directly to the AF series trims.

**C. INSTALLATION** - For fast and easy installation in existing plaster or mechanical ceilings from 1/2" to 1-3/8" thick. Four remodel clips are easily retractable for fixture removal if necessary.

**D. JUNCTION BOX** - UL listed for through-branch circuit wiring, provided with eight 1/2" KOs and four Romex knockouts with strain relief. With quick-connectors included.

**E. THERMAL PROTECTION** - Standard thermal protection device guards against improper installation, overlamping and misuse of insulation material.

### UL and C-UL listed

For Damp location  
For Feed-through wiring  
For Direct contact with insulation

### OPTION

#### 1. AIR-SHUT-

- Gasket to prevent air flow from heated or air conditioned spaces.

- Meets all national air flow requirements.



TYPE
<input type="checkbox"/> EZ6RIC-AT

USABLE WITH RL6 SERIES LED RETROFIT MODULE



imagination at work

## LED PAR30, 10-12W

Equivalent to 65W CFL Lamp  
is compatible with the series on this page.



6"

6 INCH LED / PAR LED / INCANDESCENT EZ SERIES IC HOUSING

# 6" EZ SERIES Incandescent Trims

(LAMP WATTAGE: (1) MAXIMUM 75W R/PAR30, 60W A19, 65W BR30)

Catalog Number:

Project Name:

Type:

Note:



**AF631W-WH (SOCKET SUPPORTING)  
R30/PAR30 SELF FLANGE AIR-SHUT BAFFLE**



AVAILABLE COLOR COMBINATIONS:  
W-WH, P-WH, P-BK, SN-SN, CP-CP, BZ-BZ

NEW CLIP DESIGN

**AF649W-WH (SOCKET SUPPORTING)  
R40/PAR38 DEEP SELF FLANGE AIR-SHUT BAFFLE**



AVAILABLE COLOR COMBINATIONS:  
W-WH, P-WH

NEW CLIP DESIGN

**AF630W-0V (SOCKET SUPPORTING)  
R30/PAR30 AIR-SHUT BAFFLE W/ OVER-SIZED RING**



AVAILABLE COLOR COMBINATIONS:  
W-WH, P-WH

NEW CLIP DESIGN

**AF651W (SOCKET SUPPORTING)  
R30/PAR30 CONE OPEN TRIM**



AVAILABLE COLOR:  
WHITE ONLY

NEW CLIP DESIGN

**AF637W-WH (SOCKET SUPPORTING)  
SELF FLANGE AIR-SHUT BAFFLE**



AVAILABLE COLOR COMBINATIONS:  
W-WH, P-WH, P-BK, SN-SN, CP-CP, BZ-BZ

NEW CLIP DESIGN

**AF640W-WH (SOCKET SUPPORTING)  
DEEP SELF FLANGE AIR-SHUT BAFFLE**



AVAILABLE COLOR COMBINATIONS:  
W-WH, P-WH, SN-SN, CP-CP, BZ-BZ

NEW CLIP DESIGN

**AF634W-CL-WH (SOCKET SUPPORTING)  
R30/PAR30 AIR-SHUT REFLECTOR W/ BAFFLE**



AVAILABLE COLORS:  
W-CL-WH, P-CL-WH

NEW CLIP DESIGN

**AF632RG-WH (SOCKET SUPPORTING)  
R30/PAR30 AIR-SHUT REFLECTOR**

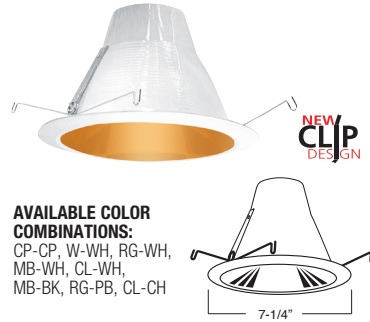

AVAILABLE COLOR COMBINATIONS:  
CP-CP, W-WH, RG-WH, MB-WH, CL-WH, MB-BK, RG-PB, CL-CH

NEW CLIP DESIGN

**AF639W-WH (SOCKET SUPPORTING)  
SELF FLANGE AIR-SHUT BAFFLE**



AVAILABLE COLOR COMBINATIONS:  
W-WH

NEW CLIP DESIGN

MATT WHITE FINISH

**AF644W-WH (SOCKET SUPPORTING)  
PAR30 OPEN RATED SHOWER TRIM**



AVAILABLE COLOR COMBINATIONS:  
W-WH, P-WH, P-BK, SN-SN, CP-CP, BZ-BZ

FOR WET LOCATION

NEW

**AF601CP (SOCKET SUPPORTING)  
METAL ALBALITE SHOWER TRIM**



LENS:  
ALBALITE

TRIM/RING FINISH:  
WH, BK, SN, CP, CH, PB, BZ

FOR WET LOCATION

**AF605PB (SOCKET SUPPORTING)  
METAL FRESNEL SHOWER TRIM**

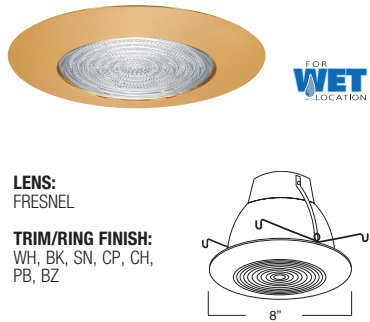

LENS:  
FRESNEL

TRIM/RING FINISH:  
WH, BK, SN, CP, CH, PB, BZ

FOR WET LOCATION

**AF606CP (SOCKET SUPPORTING)  
METAL DROP OPAL SHOWER TRIM**

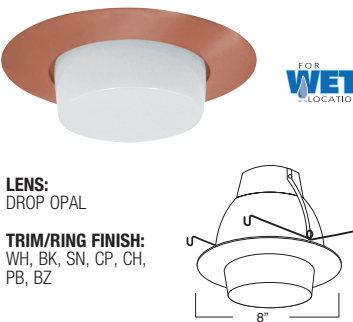

LENS:  
DROP OPAL

TRIM/RING FINISH:  
WH, BK, SN, CP, CH, PB, BZ

FOR WET LOCATION

**AF636W-WH (SOCKET SUPPORTING)  
BAFFLE W/ FRESNEL LENS**

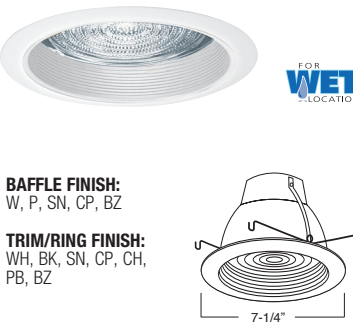

BAFFLE FINISH:  
W, P, SN, CP, BZ

TRIM/RING FINISH:  
WH, BK, SN, CP, CH, PB, BZ

FOR WET LOCATION

**AF635P-WH (SOCKET SUPPORTING)  
BAFFLE W/ ALBALITE LENS**

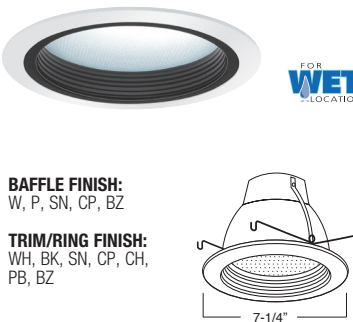

BAFFLE FINISH:  
W, P, SN, CP, BZ

TRIM/RING FINISH:  
WH, BK, SN, CP, CH, PB, BZ

FOR WET LOCATION

**AF642CL-WH (SOCKET SUPPORTING)  
REFLECTOR W/ FRESNEL LENS**

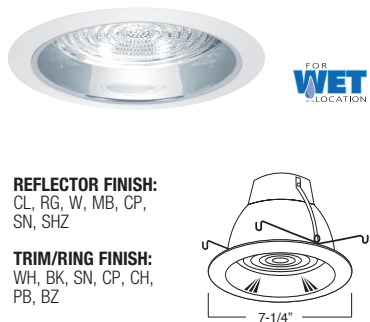

REFLECTOR FINISH:  
CL, RG, W, MB, CP, SN, SHZ

TRIM/RING FINISH:  
WH, BK, SN, CP, CH, PB, BZ

FOR WET LOCATION

# 6" EZ SERIES Incandescent Trims

( LAMP WATTAGE: (1) MAXIMUM 75W R/PAR30, 60W A19, 65W BR30)

Catalog Number:

Project Name:

Type:

Note:



**AF641RG-WH (SOCKET SUPPORTING)  
REFLECTOR W/ ALBALITE LENS**



**REFLECTOR FINISH:**  
CL, RG, W, MB, CP,  
SN, SHZ

**TRIM/RING FINISH:**  
WH, BK, SN, CP, CH,  
PB, BZ

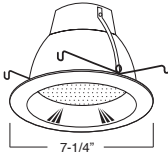

7-1/4"

**AF643RG-WH (SOCKET SUPPORTING)  
REFLECTOR W/ DROP OPAL LENS**



**REFLECTOR FINISH:**  
CL, RG, W, MB, CP,  
SN, SHZ

**TRIM/RING FINISH:**  
WH, BK, SN, CP, CH,  
PB, BZ

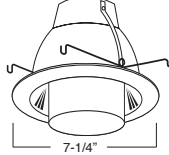

7-1/4"

**AF638W-WH (SOCKET SUPPORTING)  
BAFFLE W/ DROP OPAL LENS**



**BAFFLE FINISH:**  
W, P, SN, CP, BZ

**TRIM/RING FINISH:**  
WH, BK, SN, CP, CH,  
PB, BZ

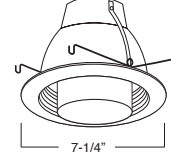

7-1/4"

**AF601L (SOCKET SUPPORTING)  
PLASTIC ALBALITE SHOWER TRIM**



**LENS:**  
ALBALITE

**TRIM/RING FINISH:**  
WHITE PLASTIC

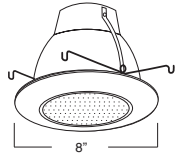

8"

**AF605L (SOCKET SUPPORTING)  
PLASTIC FRESNEL SHOWER TRIM**



**LENS:**  
FRESNEL

**TRIM/RING FINISH:**  
WHITE PLASTIC

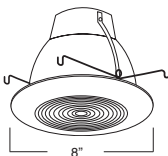

8"

**AF606L (SOCKET SUPPORTING)  
PLASTIC DROP OPAL SHOWER TRIM**



**LENS:**  
DROP OPAL

**TRIM/RING FINISH:**  
WHITE PLASTIC

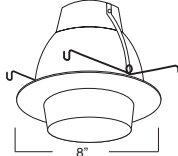

8"

**AF633CP  
SOCKET SUPPORTING R/PAR30 OPEN TRIM**

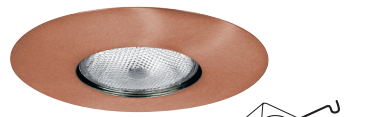

**TRIM/RING FINISH:**  
WH, BK, SN, CP, CH,  
PB, BZ

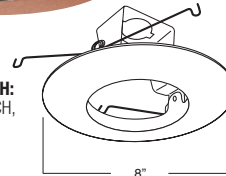

8"

**B602SN  
EYEBALL**



**TRIM/RING FINISH:**  
WH, BK, SN, CP, CH,  
PB, BZ

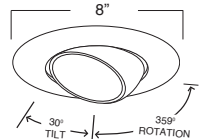

8"

**B609W-WH  
REGRESSED EYEBALL WITH BAFFLE**



**BAFFLE FINISH:**  
W, P, SN, CP, BZ

**TRIM/RING FINISH:**  
WH, BK, SN, CP, CH,  
PB, BZ

**EYEBALL FINISH:**  
WH, BK, SN, CP, CH, PB, BZ

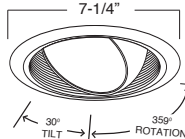

7-1/4"

**B663PB  
PAR30 GIMBAL RING**

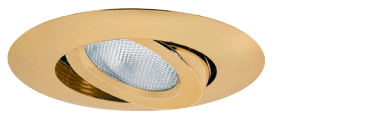

**TRIM/RING FINISH:**  
WH, BK, SN, CP, CH,  
PB, BZ

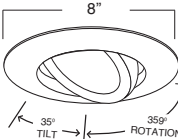

8"

**B673W-WH  
PAR30 BAFFLE W/ GIMBAL RING**



**BAFFLE FINISH:**  
W, P, SN, CP, BZ

**TRIM/RING FINISH:**  
WH, BK, SN, CP, CH,  
PB, BZ

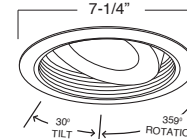

7-1/4"

BAFFLE		REFLECTOR		TRIM RING	
<b>W</b>	White	<b>CL</b>	Chrome	<b>WH</b>	White
<b>P</b>	Black	<b>RG</b>	Gold	<b>BK</b>	Black
<b>SN</b>	Satin Nickel	<b>W</b>	White	<b>SN</b>	Satin Nickel
<b>CP</b>	Copper	<b>MB</b>	Black	<b>CP</b>	Copper
<b>BZ</b>	Bronze	<b>CP</b>	Copper	<b>CH</b>	Chrome
		<b>SN</b>	Satin Nickel	<b>PB</b>	Polish Brass
				<b>BZ</b>	Bronze

\*For custom baffle, reflector, trim ring, glass color and lens options, please consult factory.