

# ONE-BOX™ Non-Metallic Outlet Boxes

*The Versatile Outlet Box for New or Old Work • 2-Hour Fire Rating*



**MOUNTS  
DIRECTLY  
to Wood or  
Steel Stud**

**F101**  
The Versatile  
Outlet Box

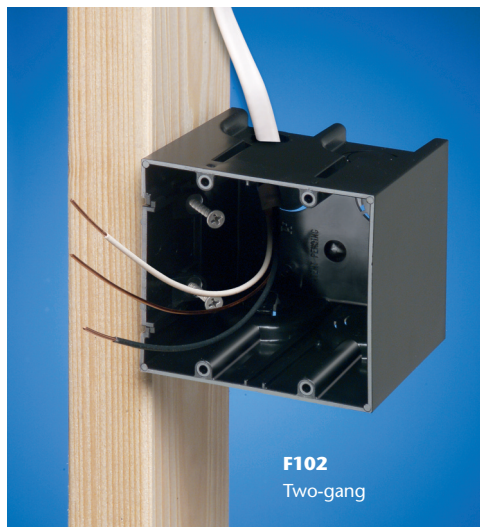

**F102**  
Two-gang



Inserting **F102D** divider  
in Four-gang **F104** ONE-BOX

Fast and easy to install, Arlington's versatile outlet box is the **ONE-BOX™** for new or old work.

It mounts directly to a wood or steel stud for a super secure installation.

Angled screws inside the ONE-BOX affix it firmly to the stud. It has no "wings" so there's no wobble.

#### **New Work**

Is ONE-BOX set too far forward or back? No problem! Back out the screws and quickly move it.

#### **Old Work**

ONE-BOX provides a secure installation, mounting directly to the stud – rather than to just the drywall.

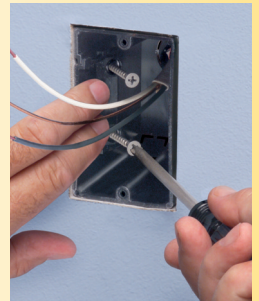

- Single gang offers extra-large capacity: 22 cubic inches
- UL Listed, 2-Hour Fire Rating
- Single and multiple gangs include installed NM cable connector
- Horizontal and vertical styles
- Optional low voltage separator for multiple gang boxes

Patented

Made in USA



**Arlington®**

1 Stauffer Industrial Park  
Scranton, PA 18517  
800/233.4717 • Fax 570/562.0646  
[www.aifittings.com](http://www.aifittings.com)

# ONE-BOX™ Non-Metallic Outlet Boxes

*Secure Installation • Mounts Directly to a Wood or Steel Stud*

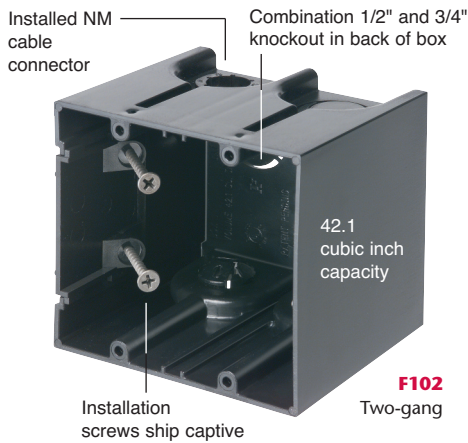

**1** Attach ONE-BOX to wood or steel stud with captive installation screws. If box is too far forward or back, back the screws out to reposition.

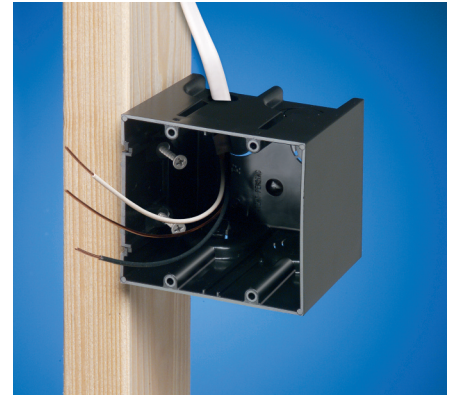

**2** Pull wire through NM cable connector. (ships installed)



**1** Position ONE-BOX adjacent to stud. Use box as template to cut hole.

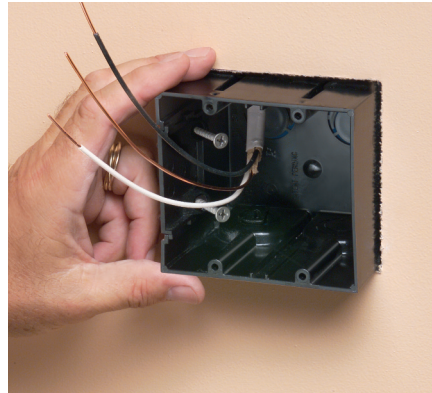

**2** Pull wire through installed NM cable connector. Insert ONE-BOX.



**3** Mount ONE-BOX directly to stud with shipped in place screws.

CATALOG NUMBER	UPC/DCI/NAED MFG. #018997	DESCRIPTION / CUBIC INCH CAPACITY	UNIT PKG	STD PKG
F101	43626	Single gang, Vertical / 22.0	50	50
F101H	43634	Single gang, Horizontal / 22.0	20	20
F102	43640	Two-gang, Vertical / 42.1	25	25
F102D	43544	Voltage divider	25	25
F103	43641	Three-gang, Vertical / 66.2	20	20
F104	43642	Four-gang, Vertical / 80.5	20	20

Add suffix 'GC' when ordering in Canada, to include ground clip, for example F101GC

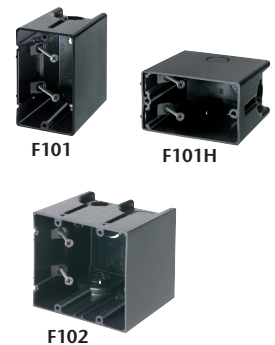

**2-Hour Fire Rating**



**Arlington®**

1 Stauffer Industrial Park  
Scranton, PA 18517  
800/233.4717 • Fax 570/562.0646  
www.aifittings.com



Made in USA

Distributed by

# ONE-BOX™ Non-Metallic Outlet Boxes

*The Versatile Outlet Box for New or Old Work • 2-Hour Fire Rating*



**MOUNTS  
DIRECTLY  
to Wood or  
Steel Stud**

**F101**  
The Versatile  
Outlet Box

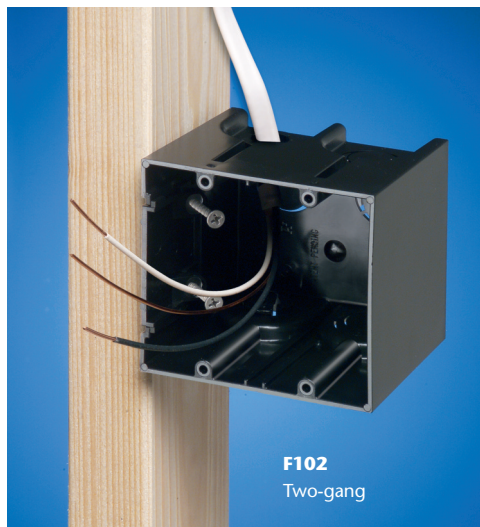

**F102**  
Two-gang



Inserting **F102D** divider  
in Four-gang **F104** ONE-BOX

Fast and easy to install, Arlington's versatile outlet box is the **ONE-BOX™** for new or old work.

It mounts directly to a wood or steel stud for a super secure installation.

Angled screws inside the ONE-BOX affix it firmly to the stud. It has no "wings" so there's no wobble.

#### **New Work**

Is ONE-BOX set too far forward or back? No problem! Back out the screws and quickly move it.

#### **Old Work**

ONE-BOX provides a secure installation, mounting directly to the stud – rather than to just the drywall.

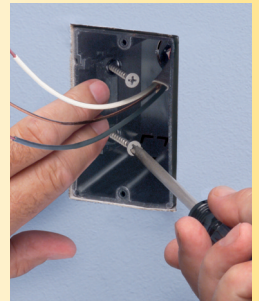

- Single gang offers extra-large capacity: 22 cubic inches
- UL Listed, 2-Hour Fire Rating
- Single and multiple gangs include installed NM cable connector
- Horizontal and vertical styles
- Optional low voltage separator for multiple gang boxes

Patented

Made in USA



**Arlington®**

1 Stauffer Industrial Park  
Scranton, PA 18517  
800/233.4717 • Fax 570/562.0646  
[www.aifittings.com](http://www.aifittings.com)

# ONE-BOX™ Non-Metallic Outlet Boxes

*Secure Installation • Mounts Directly to a Wood or Steel Stud*

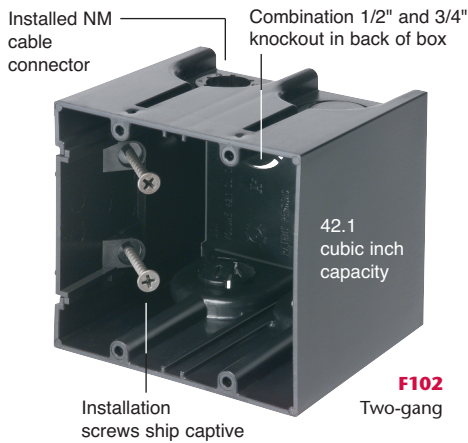

**1** Attach ONE-BOX to wood or steel stud with captive installation screws. If box is too far forward or back, back the screws out to reposition.

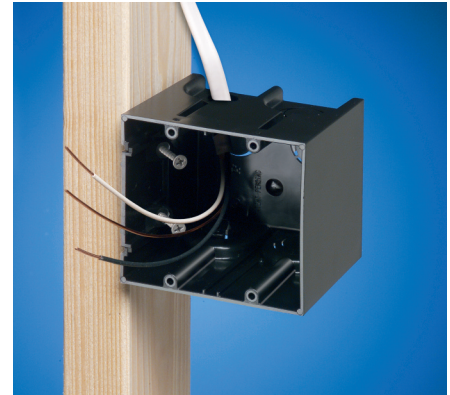

**2** Pull wire through NM cable connector. (ships installed)



**1** Position ONE-BOX adjacent to stud. Use box as template to cut hole.

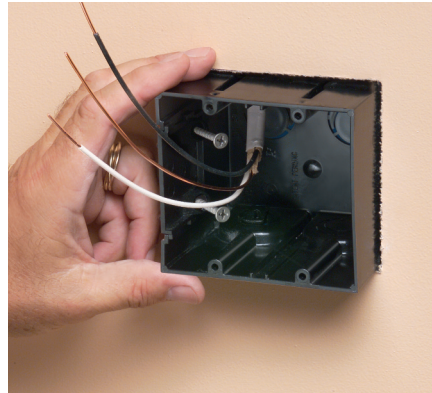

**2** Pull wire through installed NM cable connector. Insert ONE-BOX.



**3** Mount ONE-BOX directly to stud with shipped in place screws.

CATALOG NUMBER	UPC/DCI/NAED MFG. #018997	DESCRIPTION / CUBIC INCH CAPACITY	UNIT PKG	STD PKG
F101	43626	Single gang, Vertical / 22.0	50	50
F101H	43634	Single gang, Horizontal / 22.0	20	20
F102	43640	Two-gang, Vertical / 42.1	25	25
F102D	43544	Voltage divider	25	25
F103	43641	Three-gang, Vertical / 66.2	20	20
F104	43642	Four-gang, Vertical / 80.5	20	20

Add suffix 'GC' when ordering in Canada, to include ground clip, for example F101GC

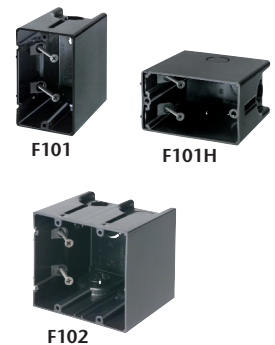

**2-Hour Fire Rating**



**Arlington®**

1 Stauffer Industrial Park  
Scranton, PA 18517  
800/233.4717 • Fax 570/562.0646  
www.aifittings.com



Made in USA

Distributed by