



# V2400 PLUGMOLD® RACEWAY AND MULTIOUTLET SYSTEM INSTALLATION INSTRUCTIONS

Installation Instruction No.: 40063R2 – Updated July 2004

Wiremold Electrical Systems conform to and should be installed and properly grounded in compliance with requirements of the current National Electrical Code, Canadian Electrical Code or codes administered by local authorities.

All electrical products may represent possible shock or fire hazard if improperly installed or used. Wiremold electrical products are UL Listed to U.S. and Canadian safety standards, made for interior use only, and should be installed in conformance with current local and/or the National Electrical Code.

- 1 No. V2400B Base section with grounding type receptacles rated 20A, 125V prewired with No. 12 type THHN conductors and snapped into base.
- 1 No. 2400C Cover section
- 1 No. 2410 Coupling
- 2 No. V2410B Blank End Fittings

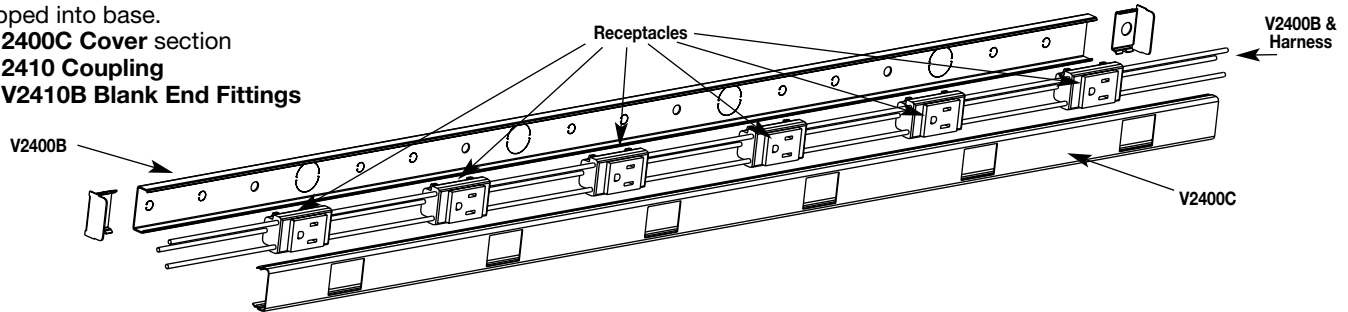

## RECOMMENDED INSTALLATION STEPS:

1. Lay out raceway path on mounting surface.
2. Locate power feed point, then install raceway base & harness (See instructions that follow).
3. Commence wiring according to instructions.
4. Install raceway covers. If any cuts are necessary, hold raceway cover up against mounted raceway base/harness so that receptacle holecuts match with receptacles. Mark cover and cut

5. Install fitting cover last over raceway covers (excluding 2410A Entrance End Cover).

**NOTE: FOR EASE OF INSTALLATION AT CORNERS** – Cut out any receptacle within 4" of wall corner. This will allow sufficient space within raceway for wire connections where two runs meet. Cut a blank raceway cover piece to fit over any exposed area, if necessary.

## FEED METHODS:

**NOTE:** Units may be end-fed as in Step 1A through V2410A Entrance End Fittings or, back-fed as in 2A or 2B through 1/2" entrance knockouts in base.

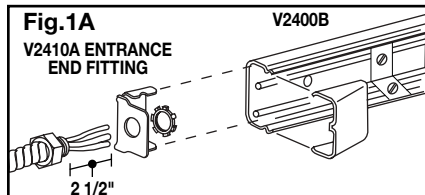

### END FEEDING FROM FLEXIBLE OR RIGID METAL CONDUIT (USING V2410A ENTRANCE END FITTING)

Mount V2400 Base and harness on surface with No. 10 Panhead screws.

Insert V2410A Entrance End Fitting base (available separately) into end of V2400B Raceway Base. Assemble 1/2" connector (not supplied) with V2410A and bring in feed cable with wires extending at least 2 1/2" beyond connector.

Connect green conductor infeed which is connected directly to the service grounding terminal using 2409 Ground Clamp, or equivalent approved method for equipment grounding connections. Connect black and white harness wires to black and white feed wires with W30 Wire Connectors (available separately) inserting only conductors of same color in a connector. See "W30 Wire Connectors... How to Use". **DO NOT USE W30 WIRE CONNECTORS WITH GROUND WIRES.** Any unused wire leads must be individually closed up with a wire nut. **DO NOT CONNECT UNUSED LEADS TOGETHER.**

Snap V2410A Fitting Cover onto raceway base. Cut raceway cover to fit and snap onto raceway base.

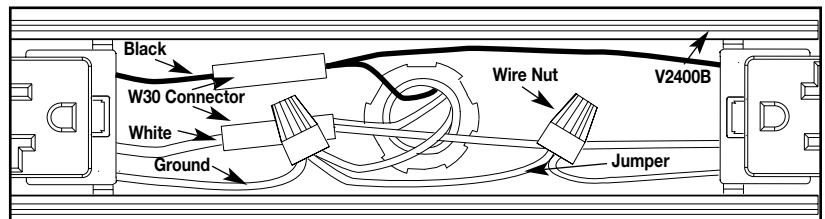

Fig. 2A W30 METHOD

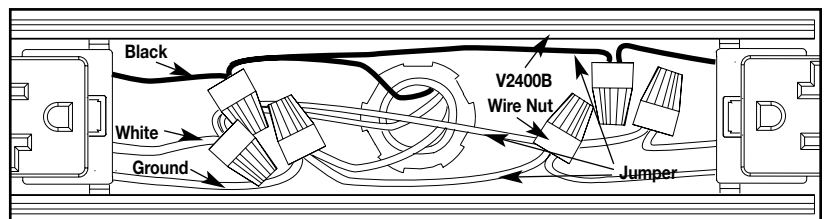

Fig. 2B WIRE NUT METHOD

### BACK FEEDING FROM FLEXIBLE OR RIGID METAL CONDUIT

Cut hot, neutral and ground wires of V2400 Raceway Harness at location of raceway base entrance knockout that will be removed. Remove 1/2" entrance knockout from base and attach 1/2" feed connector (not supplied). Mount raceway base with harness using No.10 Panhead screws. Connect harness to feed wires using one of the approved methods shown above in Fig. 2A or Fig. 2B

#### W30 WIRE CONNECTORS... HOW TO USE

W30 pressure-type connectors (available separately) are for common connection of 2, 3, or 4 No. 12 or No. 14 solid conductors.

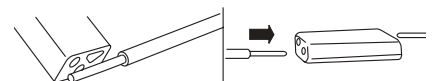

**NOT TO BE USED TO CONNECT GROUNDING CONDUCTORS.**

## COUPLING TWO PLUGMOLD V2400 WIRED SECTIONS TOGETHER TO EXTEND RUN (USING 2401 COUPLING)

Insert 2401 Coupling halfway into one end of raceway base. Mount raceway using No. 10 Panhead screws.

Insert second raceway base section onto the opposite end of 2401 Coupling. Mount second raceway section with No. 10 Panhead screws.

Connect green conductor in feed which is connected directly to the service grounding terminal using 2409 Ground Clamp or equivalent approved method

for equipment grounding connections. Connect black and white harness wires to black and white feed wires with W30 Wire Connectors (available separately) inserting only conductors of same color in a connector. See "W30 Wire Connectors... How to Use" Do not use W30 Wire Connectors with Ground wires. Any unused wire leads must be individually closed up with a wire nut. Do Not connect unused leads together.

Snap V2410A Fitting Cover onto raceway base. Cut Raceway cover to fit and snap onto raceway base.

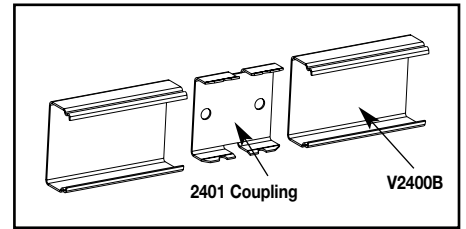

### V2406 CONNECTION COVER

V2406 may be used to cover gaps between raceway covers. Snap V2406 onto raceway at each joint.

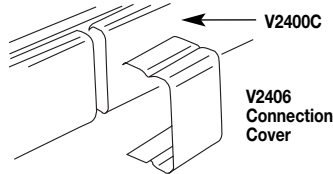

### 2400WC WIRE CLIP

Use 2400WC Wire Clips (available separately) if necessary to contain wires.

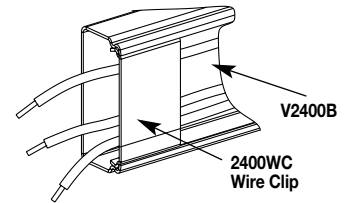

### V2417 INTERNAL ELBOW

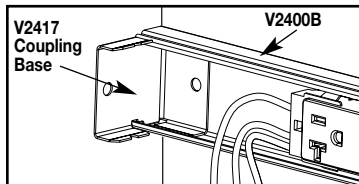

Insert short end of V2417 Coupling Base into V2400B Raceway Base. Mount the assembly to surface.

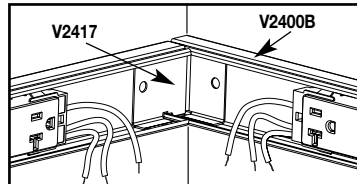

Insert the other V2400B Base into V2417 Coupling. This base section must be in contact with base already assembled to short leg of V2417 Coupling Base. **DO NOT LEAVE ANY GAPS BETWEEN THE TWO BASES.** Mount to surface with No. 10 Panhead screws.

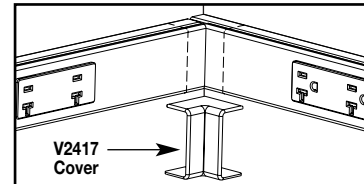

Install raceway cover next. If necessary use a blank cover piece for covering any exposed area. **DO NOT LEAVE ANY GAPS BETWEEN RACEWAY COVERS.** Snap V2417 Cover onto raceway cover at corner.

**NOTE: FOR EASE OF INSTALLATION AT CORNERS** – Cut out any receptacle within 4" of wall corner. This will allow sufficient space within raceway for wire connections where two runs meet. Cut a blank raceway cover piece to fit over any exposed area, if necessary.

## WIRE CAPACITY

### RACEWAY (without receptacles)

	#8		#10		#12		#14	
	THHN	TW	THHN	TW	THHN	TW	THHN	TW
15 AMP	13	10	26	22	41	28	56	36
20 AMP	13	10	26	22	41	28	-	-

### PLUGMOLD MULTIOUTLET SYSTEM (20 Amp Prewired GB Series)

	#8 THHN	#10 THHN	#12 THHN	#14 THHN
20 AMP	2	4	6	-

Wired Section Nos.	Base
V24GB306	
V24GB506 V24GB512	
V24GB606 V24GB612 V24GB618	



### The Wiremold Company

U.S. and International:

60 Woodlawn Street • West Hartford, CT 06110

1-800-621-0049 • FAX 860-232-2062 • Outside U.S.: 860-233-6251

Canada:

850 Gartshore Street • Fergus, Ontario N1M 2W8

1-800-741-7957 • FAX 519-843-5980

