

GR and GRF Conduit Outlet Boxes

Explosionproof, Dust-Ignitionproof

UNILETS® for use with Threaded Metal Conduit. Furnished with Internal Ground Screw and O-Ring.

Class I, Division 1 and 2, Groups B♦, C, D
Class II, Division 1 and 2, Groups E, F, G
Class III
NEMA 3, 4

Applications

- Complies with a wide range of classified area requirements.
- Corrosion-resistant: ideal indoors or out.
- For pulling of wires.
- Connect conduit lengths and change direction of conduit runs.
- Provide access for maintenance.

Features

- GR boxes offers ten hub arrangements.
- GRF boxes have integral mounting flange.
- Malleable iron bodies have high tensile strength, ductility and provides great resistance to corrosion, impact, and shock.
- Accurately tapped, tapered hub threads for tight, rigid joints and ground continuity.
- Furnished with covers.
- General purpose wiring.
- Function as sealing fittings when used with sealing covers (see NEC for restrictions).
- Internally threaded body with externally threaded cover.
- Covers have pry notches for bar or wrench.
- Accommodate sealing, dome, hub and union hub covers, and canopies.
- Standard O-rings provide raintight fit. NEMA 3, 4.
- Internal ground screw standard.
- Smooth, rounded integral bushing in each hub type box protects conductor insulation.

Standard Materials

- Body: malleable iron or copperfree (4/10 of 1% max.) aluminum
- Cover: copperfree (4/10 of 1% max.) aluminum

Standard Finishes

- Malleable iron bodies and covers: triple-coat — (1) zinc electroplate, (2) chromate, and (3) epoxy powder coat
- Aluminum bodies and covers: epoxy powder coat

Options

- To order body without cover, add suffix **-LC** to catalog number.
- For malleable iron body and cover, add suffix **-M**.
- PVC coating available on specified products. Add suffix **-PVC** to catalog number. To add PVC coating to items not specified, contact your local sales representative.

Certifications and Compliances

- Class 1, Zone 1 & 2 IIA & IIB
- UL Listed: E10444
- CSA Standard: C22.2 No. 25, C22.2 No. 30
- CSA Certified: 013017



♦ In Class I, Division 1, Group B atmospheres, all conduit runs must have a sealing fitting (not supplied) field-installed adjacent to the enclosure.

GR Conduit Outlet Boxes







Explosionproof, Dust-Ignitionproof

UNILETS® for use with Threaded Metal Conduit. Furnished with Internal Ground Screw and O-Ring.

Class I, Division 1 and 2, Groups B♦, C, D
 Class II, Division 1 and 2, Groups E, F, G
 Class III
 NEMA 3, 4

Enclosures and Junction Boxes

ENCLOSURES AND JUNCTION BOXES: HAZARDOUS LOCATION CONDUIT OUTLET BOXES

| | Hub Type | Conduit Size (Inches) | Cover Opening Inches/Millimeters | Volume Capacity in ³ /dm ³ | Form Number ^③ | Catalog Number ^① | |
|---|------------------|---|-------------------------------------|--|-----------------------------|--|---|
| | | | | | | Malleable Iron ^② Body With Aluminum Cover | Aluminum Body with Aluminum Cover |
|  | GRE | 1/2 | 3.38/85.9 | 18.0/.29 | 1 | GRE50 | GRE50-A |
| | | 3/4 | 3.38/85.9 | 18.0/.29 | 1 | GRE75 | GRE75-A |
| | | 1 | 3.38/85.9 | 18.0/.29 | 1 | GRE100 | GRE100-A |
| | | 1-1/4 | 3.94/100.1 | 31.0/.51 | 2 | GRE125 | GRE125-A |
| | | 1-1/2 | 4.88/124.0 | 72.0/1.18 | 3 | GRE150 | GRE150-A |
|  | GRC ^④ | 1/2 | 3.38/85.9 | 18.0/.29 | 1 | GRC50 | GRC50-A |
| | | 3/4 | 3.38/85.9 | 18.0/.29 | 1 | GRC75 | GRC75-A |
| | | 1 | 3.38/85.9 | 18.0/.29 | 1 | GRC100 | GRC100-A |
| | | 1-1/4 | 3.94/100.1 | 31.0/.51 | 2 | GRC125 | GRC125-A |
| | | 1-1/2 | 4.88/124.0 | 72.0/1.18 | 3 | GRC150 | GRC150-A |
| | | 2 | 4.88/124.0 | 76.0/1.25 | 3 | GRC200 | GRC200-A |
|  | GRL ^④ | 1/2 | 3.38/85.9 | 18.0/.29 | 1 | GRL50 | GRL50-A |
| | | 3/4 | 3.38/85.9 | 18.0/.29 | 1 | GRL75 | GRL75-A |
| | | 1 | 3.38/85.9 | 18.0/.29 | 1 | GRL100 | GRL100-A |
| | | 1-1/4 | 3.94/100.1 | 31.0/.51 | 2 | GRL125 | GRL125-A |
| | | 1-1/2 | 4.88/124.0 | 72.0/1.18 | 3 | GRL150 | GRL150-A |
| | | 2 | 4.88/124.0 | 76.0/1.25 | 3 | GRL200 | GRL200-A |
| | |  | GRLB ^④ | 1/2 | 3.38/85.9 | 18.0/.29 | 1 |
| 3/4 | 3.38/85.9 | | | 18.0/.29 | 1 | GRLB75 | GRLB75-A |
| 1 | 3.38/85.9 | | | 18.0/.29 | 1 | GRLB100 | GRLB100-A |
| 1-1/4 | 3.94/100.1 | | | 31.0/.51 | 2 | GRLB125 | GRLB125-A |
| 1-1/2 | 4.88/124.0 | | | 72.0/1.18 | 3 | GRLB150 | GRLB150-A |
| 2 | 4.88/124.0 | | | 76.0/1.25 | 3 | GRLB200 | GRLB200-A |
|  | GRN ^④ | | | 1/2 | 3.38/85.9 | 18.0/.29 | 1 |
| | | 3/4 | 3.38/85.9 | 18.0/.29 | 1 | GRN75 | GRN75-A |
| | | 1 | 3.38/85.9 | 18.0/.29 | 1 | GRN100 | GRN100-A |
| | | 1-1/4 | 3.94/100.1 | 31.0/.51 | 2 | GRN125 | GRN125-A |
| | | 1-1/2 | 4.88/124.0 | 72.0/1.18 | 3 | GRN150 | GRN150-A |
|  | GRT ^④ | 1/2 | 3.38/85.9 | 18.0/.29 | 1 | GRT50 | GRT50-A |
| | | 3/4 | 3.38/85.9 | 18.0/.29 | 1 | GRT75 | GRT75-A |
| | | 1 | 3.38/85.9 | 18.0/.29 | 1 | GRT100 | GRT100-A |
| | | 1-1/4 | 3.94/100.1 | 31.0/.51 | 2 | GRT125 | GRT125-A |
| | | 1-1/2 | 4.88/124.0 | 72.0/1.18 | 3 | GRT150 | GRT150-A |
| | | 2 | 4.88/124.0 | 76.0/1.25 | 3 | GRT200 | GRT200-A |
|  | GRX ^④ | 1/2 | 3.38/85.9 | 18.0/.29 | 1 | GRX50 | GRX50-A |
| | | 3/4 | 3.38/85.9 | 18.0/.29 | 1 | GRX75 | GRX75-A |
| | | 1 | 3.38/85.9 | 18.0/.29 | 1 | GRX100 | GRX100-A |
| | | 1-1/4 | 3.94/100.1 | 31.0/.51 | 2 | GRX125 | GRX125-A |
| | | 1-1/2 | 4.88/124.0 | 72.0/1.18 | 3 | GRX150 | GRX150-A |
| | | 2 | 4.88/124.0 | 76.0/1.25 | 3 | GRX200 | GRX200-A |

♦ In Class I, Division 1, Group B atmospheres, all conduit runs must have a sealing fitting (not supplied) field-installed adjacent to the enclosure.

① Other covers available—see GR and GRF Conduit Outlet Box Covers page. Order separately.

② For malleable iron body and cover, add suffix **-M**.

③ Form number designates body and matching cover sizes. To order body without cover, add suffix **-LC** to catalog number.



④ PVC coating available, add suffix **-PVC** to catalog number.

GR Conduit Outlet Boxes

Explosionproof, Dust-Ignitionproof

UNILETS® for use with Threaded Metal Conduit. Furnished with Internal Ground Screw and O-Ring.

Class I, Division 1 and 2, Groups B♦, C, D
 Class II, Division 1 and 2, Groups E, F, G
 Class III
 NEMA 3, 4

| Hub Type | Conduit Size (Inches) | Cover Opening Inches/Millimeters | Volume Capacity in ³ /dm ³ | Form Number ③ | Catalog Number ① | |
|---|-----------------------|----------------------------------|--|---------------|---|-----------------------------------|
| | | | | | Malleable Iron ② Body With Aluminum Cover | Aluminum Body with Aluminum Cover |
|  | 1/2 | 3.38/85.9 | 18.0/0.29 | 1 | GRCA50 | GRCA50-A |
| | 3/4 | 3.38/85.9 | 18.0/0.29 | 1 | GRCA75 | GRCA75-A |
|  | 1/2 | 3.38/85.9 | 18.0/0.29 | 1 | GRLA50 | GRLA50-A |
| | 3/4 | 3.38/85.9 | 18.0/0.29 | 1 | GRLA75 | GRLA75-A |
|  | 1/2 | 3.38/85.9 | 18.0/0.29 | 1 | GRTA50 | GRTA50-A |
| | 3/4 | 3.38/85.9 | 18.0/0.29 | 1 | GRTA75 | GRTA75-A |

Dimensions

| Hub Size (Inches) | Dimensions in Inches/Millimeters | | | | | | |
|---------------------------------|----------------------------------|------------|------------|-----------|-----------|------------|-----------|
| | A | B | C | D | E | F | G |
| GR Series, Form 1 | | | | | | | |
| 1/2 | 3.75/95.3 | 2.44/62 | 2.88/73.2 | 0.75/19.1 | 0.81/20.6 | 2.25/57.2 | 1.25/31.8 |
| 3/4 | 3.75/95.3 | 2.44/62 | 2.88/73.2 | 0.75/19.1 | 0.81/20.6 | 2.25/57.2 | 1.25/31.8 |
| 1 | 3.75/95.3 | 2.44/62 | 2.88/73.2 | 0.94/23.9 | 0.94/23.9 | 2.25/57.2 | 1.06/26.9 |
| GR Series, Forms 2 and 3 | | | | | | | |
| 1-1/4 | 4.50/114.3 | 2.69/68.3 | 3.56/90.4 | 1.19/30.2 | 0.88/22.4 | 2.75/69.9 | 1.13/28.7 |
| 1-1/2 | 5.75/146.1 | 3.75/95.3 | 4.81/122.2 | 1.38/35.1 | 0.94/23.9 | 4.06/103.1 | 1.50/38.1 |
| 2 | 5.75/146.1 | 4.00/101.6 | 5.06/128.5 | 1.63/41.4 | 1/25.4 | 4.25/108.0 | 1.25/31.8 |

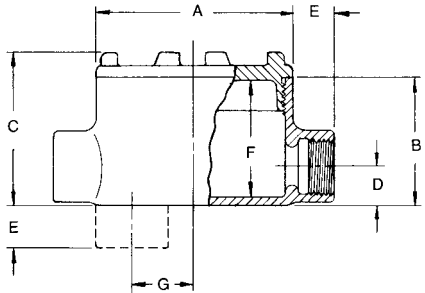

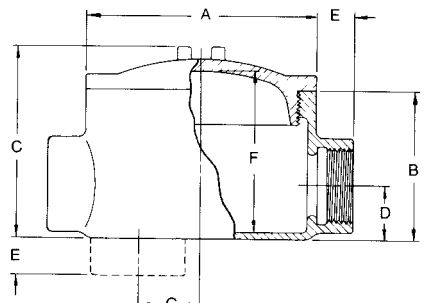

♦ In Class I, Division 1, Group B atmospheres, all conduit runs must have a sealing fitting (not supplied) field-installed adjacent to the enclosure.
 ① Other covers available—see GR and GRF Conduit Outlet Box Covers page. Order separately.
 ② For malleable iron body and cover, add suffix **-M**.
 ③ Form number designates body and matching cover sizes. To order body without cover, add suffix **-LC** to catalog number.

GRF Flanged Conduit Outlet Boxes





Explosionproof, Dust-Ignitionproof

UNILETS® for use with Threaded Metal Conduit. Furnished with Internal Ground Screw and O-Ring.

Class I, Division 1 and 2, Groups B♦, C, D
 Class II, Division 1 and 2, Groups E, F, G
 Class III
 NEMA 3, 4

Enclosures and Junction Boxes

ENCLOSURES AND JUNCTION BOXES: HAZARDOUS LOCATION CONDUIT OUTLET BOXES

| | Hub Type | Conduit Size (Inches) | Cover Opening Inches/Millimeters | Capacity in ³ /dm ³ | Form Number ③ | Catalog Number ① | |
|--|----------|-----------------------|----------------------------------|---|---------------|---|-----------------------------------|
| | | | | | | Malleable Iron ② Body With Aluminum Cover | Aluminum Body with Aluminum Cover |
|  | GRFC | 1/2 | 3.38/85.9 | 18.0/0.29 | 1 | GRFC50 | GRFC50-A |
| | | 3/4 | 3.38/85.9 | 18.0/0.29 | 1 | GRFC75 | GRFC75-A |
| | | 1 | 3.38/85.9 | 18.0/0.29 | 1 | GRFC100 | GRFC100-A |
|  | GRFL | 1/2 | 3.38/85.9 | 18.0/0.29 | 1 | GRFL50 | GRFL50-A |
| | | 3/4 | 3.38/85.9 | 18.0/0.29 | 1 | GRFL75 | GRFL75-A |
| | | 1 | 3.38/85.9 | 18.0/0.29 | 1 | GRFL100 | GRFL100-A |
|  | GRFT | 1/2 | 3.38/85.9 | 18.0/0.29 | 1 | GRFT50 | GRFT50-A |
| | | 3/4 | 3.38/85.9 | 18.0/0.29 | 1 | GRFT75 | GRFT75-A |
| | | 1 | 3.38/85.9 | 18.0/0.29 | 1 | GRFT100 | GRFT100-A |
|  | GRFX | 1/2 | 3.38/85.9 | 18.0/0.29 | 1 | GRFX50 | GRFX50-A |
| | | 3/4 | 3.38/85.9 | 18.0/0.29 | 1 | GRFX75 | GRFX75-A |
| | | 1 | 3.38/85.9 | 18.0/0.29 | 1 | GRFX100 | GRFX100-A |

Dimensions

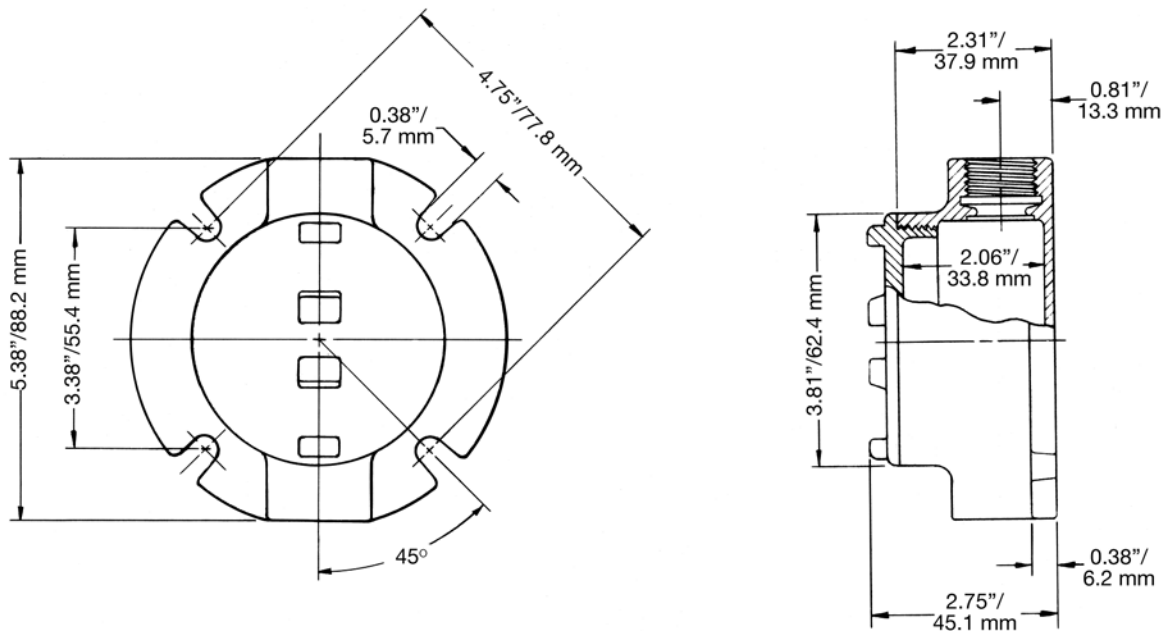

♦ In Class I, Division 1, Group B atmospheres, all conduit runs must have a sealing fitting (not supplied) field-installed adjacent to the enclosure.

① Other covers available—see GR and GRF Conduit Outlet Box Covers page. Order separately

② For malleable iron body and cover, add suffix **-M**.









③ Form number designates body and matching cover sizes. To order body without cover, add suffix **-LC** to catalog number.

GR and GRF Conduit Outlet Box Covers

Explosionproof, Dust-Ignitionproof

Covers and O-rings Fit Bodies with Corresponding Form Numbers.

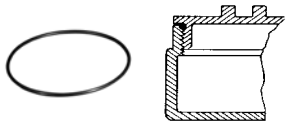
Class I, Division 1 and 2, Groups B♦, C, D
 Class II, Division 1 and 2, Groups E, F, G
 Class III
 NEMA 3, 4

| | Hub Type | Cover Opening Inches/Millimeters | Fixture Stem Size Inches/Millimeters | Form Number ① | Catalog Number | |
|---|--|-------------------------------------|---|------------------|----------------|-----------|
| | | | | | Malleable Iron | Aluminum |
|  | Surface ② | 3.38/85.9 | | 1 | GRK-1M | GRK-1 |
| | | 3.94/100.1 | | 2 | GRK-2M | GRK-2 |
| | | 4.88/124.0 | | 3 | GRK-3M | GRK-3 |
|  | Sealing ② | 3.38/85.9 | | 1 | GRK-1SC | GRK-1SC-A |
| | | 3.94/100.1 | | 2 | GRK-2SC | GRK-2SC-A |
| | | 4.88/124.0 | | 3 | GRK-3SC | GRK-3SC-A |
|  | 2" Deep Dome <i>UL Listed: E185964</i> | 3.38/85.9 | | 1 | — | GRK-1DC |
|  | Union Hub | 3.38/85.9 | 0.75/19.1 | 1 | GRK-75U | GRK-75UA |
|  | Hub | 3.38/85.9 | 0.50/12.7 | 1 | GRK-50 | GRK50-A |
| | | 3.38/85.9 | 0.75/19.1 | 1 | GRK-75 | GRK75-A |
|  | Canopy Length 4-1/2" | 3.38/85.9 | 0.50/12.7 | 1 | GRK-50C | — |
| | | 3.38/85.9 | 0.75/19.1 | 1 | GRK-75C | — |
| | | 3.38/85.9 | 1.00/25.4 | 1 | GRK-100C | — |
| | | | | | Catalog Number | |
|  | O-Rings — Buna-N | | | | | |
| | Provide Raintight fit when used on following series: GR (Forms 1, 2 and 3), GRF (Form 1), GRH, and GRU (Form 1). | | | 1 | GRG-1 | |
| | | | | 2 | GRG-2 | |
| | | | 3 | GRG-3 | | |
| GRTB Terminal Strip | | | | | | |
| <i>For use in standard GR series boxes Weidmuller type MK terminal block ③ with wire range of #22-#12 AWG. Mounts on 2 predrilled and tapped standard holes (furnished in internal GR boxes).</i> | | | | | | |
|  | 6 position terminal block kit | | | 1+2 | GRTB6-12 | |
| | 6 position terminal block kit | | | 3 | GRTB6-3 | |
| | 12 position terminal block kit | | | 3 | GRTB12-3 | |

♦ In Class I, Division 1, Group B atmospheres, all conduit runs must have a sealing fitting (not supplied) field-installed adjacent to the enclosure.

① Form numbers designate cover and matching body sizes.

② PVC coating available, add suffix **-PVC** to catalog number.

③ Terminal block is UL listed for 300 Volt, 25 Amp. CSA certified for 300 Volt, 13 Amp.

GR and GRF Conduit Outlet Boxes

Explosionproof, Dust-Ignitionproof

UNILETS® for use with Threaded Metal Conduit. Furnished with Internal Ground Screw and O-Ring.

Class I, Division 1 and 2, Groups B♦, C, D
Class II, Division 1 and 2, Groups E, F, G
Class III
NEMA 3, 4

Applications

- Complies with a wide range of classified area requirements.
- Corrosion-resistant: ideal indoors or out.
- For pulling of wires.
- Connect conduit lengths and change direction of conduit runs.
- Provide access for maintenance.

Features

- GR boxes offers ten hub arrangements.
- GRF boxes have integral mounting flange.
- Malleable iron bodies have high tensile strength, ductility and provides great resistance to corrosion, impact, and shock.
- Accurately tapped, tapered hub threads for tight, rigid joints and ground continuity.
- Furnished with covers.
- General purpose wiring.
- Function as sealing fittings when used with sealing covers (see NEC for restrictions).
- Internally threaded body with externally threaded cover.
- Covers have pry notches for bar or wrench.
- Accommodate sealing, dome, hub and union hub covers, and canopies.
- Standard O-rings provide raintight fit. NEMA 3, 4.
- Internal ground screw standard.
- Smooth, rounded integral bushing in each hub type box protects conductor insulation.

Standard Materials

- Body: malleable iron or copperfree (4/10 of 1% max.) aluminum
- Cover: copperfree (4/10 of 1% max.) aluminum

Standard Finishes

- Malleable iron bodies and covers: triple-coat — (1) zinc electroplate, (2) chromate, and (3) epoxy powder coat
- Aluminum bodies and covers: epoxy powder coat

Options

- To order body without cover, add suffix **-LC** to catalog number.
- For malleable iron body and cover, add suffix **-M**.
- PVC coating available on specified products. Add suffix **-PVC** to catalog number. To add PVC coating to items not specified, contact your local sales representative.

Certifications and Compliances

- Class 1, Zone 1 & 2 IIA & IIB
- UL Listed: E10444
- CSA Standard: C22.2 No. 25, C22.2 No. 30
- CSA Certified: 013017



♦ In Class I, Division 1, Group B atmospheres, all conduit runs must have a sealing fitting (not supplied) field-installed adjacent to the enclosure.

GR Conduit Outlet Boxes







Explosionproof, Dust-Ignitionproof

UNILETS® for use with Threaded Metal Conduit. Furnished with Internal Ground Screw and O-Ring.

Class I, Division 1 and 2, Groups B♦, C, D
 Class II, Division 1 and 2, Groups E, F, G
 Class III
 NEMA 3, 4

Enclosures and Junction Boxes

ENCLOSURES AND JUNCTION BOXES: HAZARDOUS LOCATION CONDUIT OUTLET BOXES

| | Hub Type | Conduit Size (Inches) | Cover Opening Inches/Millimeters | Volume Capacity in ³ /dm ³ | Form Number ^③ | Catalog Number ^① | |
|---|-------------------|-----------------------|----------------------------------|--|--------------------------|--|-----------------------------------|
| | | | | | | Malleable Iron ^② Body With Aluminum Cover | Aluminum Body with Aluminum Cover |
|  | GRE | 1/2 | 3.38/85.9 | 18.0/29 | 1 | GRE50 | GRE50-A |
| | | 3/4 | 3.38/85.9 | 18.0/29 | 1 | GRE75 | GRE75-A |
| | | 1 | 3.38/85.9 | 18.0/29 | 1 | GRE100 | GRE100-A |
| | | 1-1/4 | 3.94/100.1 | 31.0/51 | 2 | GRE125 | GRE125-A |
| | | 1-1/2 | 4.88/124.0 | 72.0/1.18 | 3 | GRE150 | GRE150-A |
|  | GRC ^④ | 1/2 | 3.38/85.9 | 18.0/29 | 1 | GRC50 | GRC50-A |
| | | 3/4 | 3.38/85.9 | 18.0/29 | 1 | GRC75 | GRC75-A |
| | | 1 | 3.38/85.9 | 18.0/29 | 1 | GRC100 | GRC100-A |
| | | 1-1/4 | 3.94/100.1 | 31.0/51 | 2 | GRC125 | GRC125-A |
| | | 1-1/2 | 4.88/124.0 | 72.0/1.18 | 3 | GRC150 | GRC150-A |
| | | 2 | 4.88/124.0 | 76.0/1.25 | 3 | GRC200 | GRC200-A |
|  | GRL ^④ | 1/2 | 3.38/85.9 | 18.0/29 | 1 | GRL50 | GRL50-A |
| | | 3/4 | 3.38/85.9 | 18.0/29 | 1 | GRL75 | GRL75-A |
| | | 1 | 3.38/85.9 | 18.0/29 | 1 | GRL100 | GRL100-A |
| | | 1-1/4 | 3.94/100.1 | 31.0/51 | 2 | GRL125 | GRL125-A |
| | | 1-1/2 | 4.88/124.0 | 72.0/1.18 | 3 | GRL150 | GRL150-A |
| | | 2 | 4.88/124.0 | 76.0/1.25 | 3 | GRL200 | GRL200-A |
|  | GRLB ^④ | 1/2 | 3.38/85.9 | 18.0/29 | 1 | GRLB50 | GRLB50-A |
| | | 3/4 | 3.38/85.9 | 18.0/29 | 1 | GRLB75 | GRLB75-A |
| | | 1 | 3.38/85.9 | 18.0/29 | 1 | GRLB100 | GRLB100-A |
| | | 1-1/4 | 3.94/100.1 | 31.0/51 | 2 | GRLB125 | GRLB125-A |
| | | 1-1/2 | 4.88/124.0 | 72.0/1.18 | 3 | GRLB150 | GRLB150-A |
| | | 2 | 4.88/124.0 | 76.0/1.25 | 3 | GRLB200 | GRLB200-A |
|  | GRN ^④ | 1/2 | 3.38/85.9 | 18.0/29 | 1 | GRN50 | GRN50-A |
| | | 3/4 | 3.38/85.9 | 18.0/29 | 1 | GRN75 | GRN75-A |
| | | 1 | 3.38/85.9 | 18.0/29 | 1 | GRN100 | GRN100-A |
| | | 1-1/4 | 3.94/100.1 | 31.0/51 | 2 | GRN125 | GRN125-A |
| | | 1-1/2 | 4.88/124.0 | 72.0/1.18 | 3 | GRN150 | GRN150-A |
|  | GRT ^④ | 1/2 | 3.38/85.9 | 18.0/29 | 1 | GRT50 | GRT50-A |
| | | 3/4 | 3.38/85.9 | 18.0/29 | 1 | GRT75 | GRT75-A |
| | | 1 | 3.38/85.9 | 18.0/29 | 1 | GRT100 | GRT100-A |
| | | 1-1/4 | 3.94/100.1 | 31.0/51 | 2 | GRT125 | GRT125-A |
| | | 1-1/2 | 4.88/124.0 | 72.0/1.18 | 3 | GRT150 | GRT150-A |
| | | 2 | 4.88/124.0 | 76.0/1.25 | 3 | GRT200 | GRT200-A |
|  | GRX ^④ | 1/2 | 3.38/85.9 | 18.0/29 | 1 | GRX50 | GRX50-A |
| | | 3/4 | 3.38/85.9 | 18.0/29 | 1 | GRX75 | GRX75-A |
| | | 1 | 3.38/85.9 | 18.0/29 | 1 | GRX100 | GRX100-A |
| | | 1-1/4 | 3.94/100.1 | 31.0/51 | 2 | GRX125 | GRX125-A |
| | | 1-1/2 | 4.88/124.0 | 72.0/1.18 | 3 | GRX150 | GRX150-A |
| | | 2 | 4.88/124.0 | 76.0/1.25 | 3 | GRX200 | GRX200-A |

♦ In Class I, Division 1, Group B atmospheres, all conduit runs must have a sealing fitting (not supplied) field-installed adjacent to the enclosure.

① Other covers available—see GR and GRF Conduit Outlet Box Covers page. Order separately.

② For malleable iron body and cover, add suffix **-M**.

③ Form number designates body and matching cover sizes. To order body without cover, add suffix **-LC** to catalog number.



④ PVC coating available, add suffix **-PVC** to catalog number.

GR Conduit Outlet Boxes

Explosionproof, Dust-Ignitionproof

UNILETS® for use with Threaded Metal Conduit. Furnished with Internal Ground Screw and O-Ring.

Class I, Division 1 and 2, Groups B♦, C, D
 Class II, Division 1 and 2, Groups E, F, G
 Class III
 NEMA 3, 4

| Hub Type | Conduit Size (Inches) | Cover Opening Inches/Millimeters | Volume Capacity in ³ /dm ³ | Form Number ③ | Catalog Number ① | |
|---|-----------------------|----------------------------------|--|---------------|---|-----------------------------------|
| | | | | | Malleable Iron ② Body With Aluminum Cover | Aluminum Body with Aluminum Cover |
|  | 1/2 | 3.38/85.9 | 18.0/0.29 | 1 | GRCA50 | GRCA50-A |
| | 3/4 | 3.38/85.9 | 18.0/0.29 | 1 | GRCA75 | GRCA75-A |
|  | 1/2 | 3.38/85.9 | 18.0/0.29 | 1 | GRLA50 | GRLA50-A |
| | 3/4 | 3.38/85.9 | 18.0/0.29 | 1 | GRLA75 | GRLA75-A |
|  | 1/2 | 3.38/85.9 | 18.0/0.29 | 1 | GRTA50 | GRTA50-A |
| | 3/4 | 3.38/85.9 | 18.0/0.29 | 1 | GRTA75 | GRTA75-A |

Dimensions

| Hub Size (Inches) | Dimensions in Inches/Millimeters | | | | | | |
|---------------------------------|----------------------------------|------------|------------|-----------|-----------|------------|-----------|
| | A | B | C | D | E | F | G |
| GR Series, Form 1 | | | | | | | |
| 1/2 | 3.75/95.3 | 2.44/62 | 2.88/73.2 | 0.75/19.1 | 0.81/20.6 | 2.25/57.2 | 1.25/31.8 |
| 3/4 | 3.75/95.3 | 2.44/62 | 2.88/73.2 | 0.75/19.1 | 0.81/20.6 | 2.25/57.2 | 1.25/31.8 |
| 1 | 3.75/95.3 | 2.44/62 | 2.88/73.2 | 0.94/23.9 | 0.94/23.9 | 2.25/57.2 | 1.06/26.9 |
| GR Series, Forms 2 and 3 | | | | | | | |
| 1-1/4 | 4.50/114.3 | 2.69/68.3 | 3.56/90.4 | 1.19/30.2 | 0.88/22.4 | 2.75/69.9 | 1.13/28.7 |
| 1-1/2 | 5.75/146.1 | 3.75/95.3 | 4.81/122.2 | 1.38/35.1 | 0.94/23.9 | 4.06/103.1 | 1.50/38.1 |
| 2 | 5.75/146.1 | 4.00/101.6 | 5.06/128.5 | 1.63/41.4 | 1/25.4 | 4.25/108.0 | 1.25/31.8 |

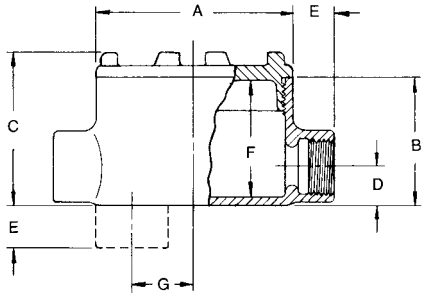

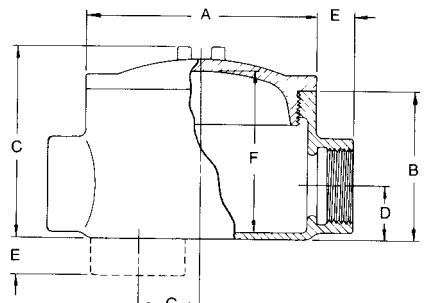

♦ In Class I, Division 1, Group B atmospheres, all conduit runs must have a sealing fitting (not supplied) field-installed adjacent to the enclosure.
 ① Other covers available—see GR and GRF Conduit Outlet Box Covers page. Order separately.
 ② For malleable iron body and cover, add suffix **-M**.
 ③ Form number designates body and matching cover sizes. To order body without cover, add suffix **-LC** to catalog number.

GRF Flanged Conduit Outlet Boxes





Explosionproof, Dust-Ignitionproof

UNILETS® for use with Threaded Metal Conduit. Furnished with Internal Ground Screw and O-Ring.

Class I, Division 1 and 2, Groups B♦, C, D
 Class II, Division 1 and 2, Groups E, F, G
 Class III
 NEMA 3, 4

Enclosures and Junction Boxes

ENCLOSURES AND JUNCTION BOXES: HAZARDOUS LOCATION CONDUIT OUTLET BOXES

| | Hub Type | Conduit Size (Inches) | Cover Opening Inches/Millimeters | Capacity in ³ /dm ³ | Form Number ③ | Catalog Number ① | |
|--|----------|-----------------------|----------------------------------|---|---------------|---|-----------------------------------|
| | | | | | | Malleable Iron ② Body With Aluminum Cover | Aluminum Body with Aluminum Cover |
|  | GRFC | 1/2 | 3.38/85.9 | 18.0/0.29 | 1 | GRFC50 | GRFC50-A |
| | | 3/4 | 3.38/85.9 | 18.0/0.29 | 1 | GRFC75 | GRFC75-A |
| | | 1 | 3.38/85.9 | 18.0/0.29 | 1 | GRFC100 | GRFC100-A |
|  | GRFL | 1/2 | 3.38/85.9 | 18.0/0.29 | 1 | GRFL50 | GRFL50-A |
| | | 3/4 | 3.38/85.9 | 18.0/0.29 | 1 | GRFL75 | GRFL75-A |
| | | 1 | 3.38/85.9 | 18.0/0.29 | 1 | GRFL100 | GRFL100-A |
|  | GRFT | 1/2 | 3.38/85.9 | 18.0/0.29 | 1 | GRFT50 | GRFT50-A |
| | | 3/4 | 3.38/85.9 | 18.0/0.29 | 1 | GRFT75 | GRFT75-A |
| | | 1 | 3.38/85.9 | 18.0/0.29 | 1 | GRFT100 | GRFT100-A |
|  | GRFX | 1/2 | 3.38/85.9 | 18.0/0.29 | 1 | GRFX50 | GRFX50-A |
| | | 3/4 | 3.38/85.9 | 18.0/0.29 | 1 | GRFX75 | GRFX75-A |
| | | 1 | 3.38/85.9 | 18.0/0.29 | 1 | GRFX100 | GRFX100-A |

Dimensions

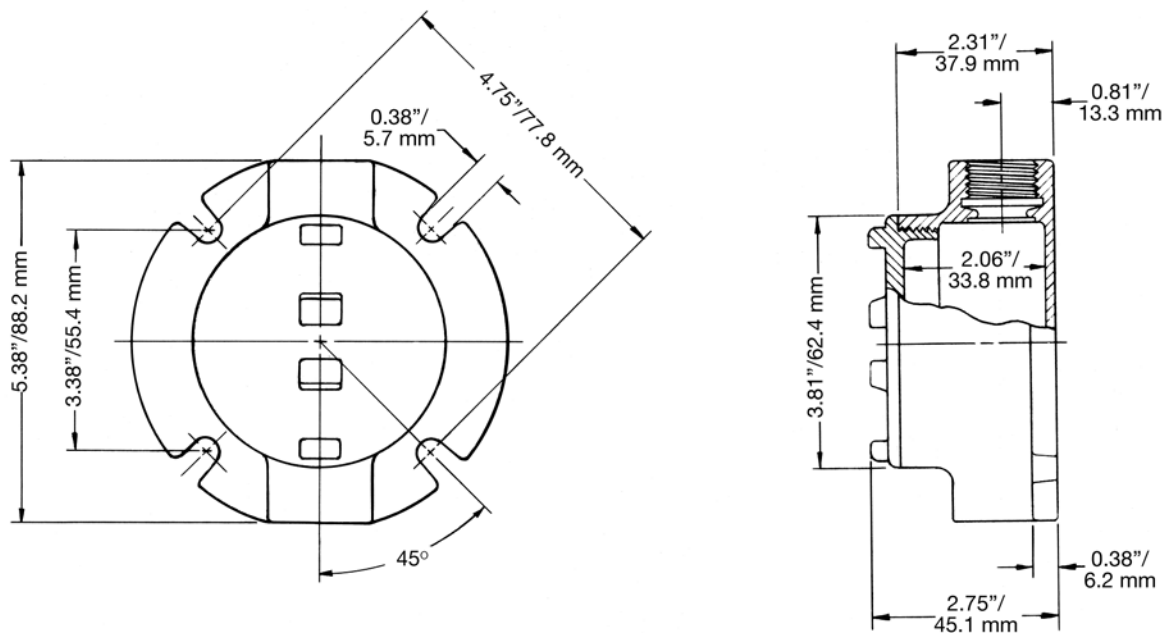

♦ In Class I, Division 1, Group B atmospheres, all conduit runs must have a sealing fitting (not supplied) field-installed adjacent to the enclosure.

① Other covers available—see GR and GRF Conduit Outlet Box Covers page. Order separately

② For malleable iron body and cover, add suffix **-M**.









③ Form number designates body and matching cover sizes. To order body without cover, add suffix **-LC** to catalog number.

GR and GRF Conduit Outlet Box Covers

Explosionproof, Dust-Ignitionproof

Covers and O-rings Fit Bodies with Corresponding Form Numbers.

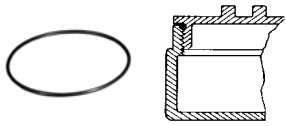
Class I, Division 1 and 2, Groups B♦, C, D
 Class II, Division 1 and 2, Groups E, F, G
 Class III
 NEMA 3, 4

| | Hub Type | Cover Opening Inches/Millimeters | Fixture Stem Size Inches/Millimeters | Form Number ① | Catalog Number | |
|---|--|-------------------------------------|---|------------------|----------------|-----------|
| | | | | | Malleable Iron | Aluminum |
|  | Surface ② | 3.38/85.9 | | 1 | GRK-1M | GRK-1 |
| | | 3.94/100.1 | | 2 | GRK-2M | GRK-2 |
| | | 4.88/124.0 | | 3 | GRK-3M | GRK-3 |
|  | Sealing ② | 3.38/85.9 | | 1 | GRK-1SC | GRK-1SC-A |
| | | 3.94/100.1 | | 2 | GRK-2SC | GRK-2SC-A |
| | | 4.88/124.0 | | 3 | GRK-3SC | GRK-3SC-A |
|  | 2" Deep Dome <i>UL Listed: E185964</i> | 3.38/85.9 | | 1 | — | GRK-1DC |
|  | Union Hub | 3.38/85.9 | 0.75/19.1 | 1 | GRK-75U | GRK-75UA |
|  | Hub | 3.38/85.9 | 0.50/12.7 | 1 | GRK-50 | GRK50-A |
| | | 3.38/85.9 | 0.75/19.1 | 1 | GRK-75 | GRK75-A |
|  | Canopy Length 4-1/2" | 3.38/85.9 | 0.50/12.7 | 1 | GRK-50C | — |
| | | 3.38/85.9 | 0.75/19.1 | 1 | GRK-75C | — |
| | | 3.38/85.9 | 1.00/25.4 | 1 | GRK-100C | — |
| | | | | | Catalog Number | |
|  | O-Rings — Buna-N | | | | | |
| | Provide Raintight fit when used on following series: GR (Forms 1, 2 and 3), GRF (Form 1), GRH, and GRU (Form 1). | | | 1 | GRG-1 | |
| | | | | 2 | GRG-2 | |
| | | | 3 | GRG-3 | | |
| GRTB Terminal Strip | | | | | | |
| <i>For use in standard GR series boxes Weidmuller type MK terminal block ③ with wire range of #22-#12 AWG. Mounts on 2 predrilled and tapped standard holes (furnished in internal GR boxes).</i> | | | | | | |
|  | 6 position terminal block kit | | | 1+2 | GRTB6-12 | |
| | 6 position terminal block kit | | | 3 | GRTB6-3 | |
| | 12 position terminal block kit | | | 3 | GRTB12-3 | |

♦ In Class I, Division 1, Group B atmospheres, all conduit runs must have a sealing fitting (not supplied) field-installed adjacent to the enclosure.

① Form numbers designate cover and matching body sizes.

② PVC coating available, add suffix **-PVC** to catalog number.

③ Terminal block is UL listed for 300 Volt, 25 Amp. CSA certified for 300 Volt, 13 Amp.