

# GR and GRF Conduit Outlet Boxes

## Explosionproof, Dust-Ignitionproof

UNILETS® for use with Threaded Metal Conduit. Furnished with Internal Ground Screw and O-Ring.

Class I, Division 1 and 2, Groups B♦, C, D  
Class II, Division 1 and 2, Groups E, F, G  
Class III  
NEMA 3, 4

### Applications

- Complies with a wide range of classified area requirements.
- Corrosion-resistant: ideal indoors or out.
- For pulling of wires.
- Connect conduit lengths and change direction of conduit runs.
- Provide access for maintenance.

### Features

- GR boxes offers ten hub arrangements.
- GRF boxes have integral mounting flange.
- Malleable iron bodies have high tensile strength, ductility and provides great resistance to corrosion, impact, and shock.
- Accurately tapped, tapered hub threads for tight, rigid joints and ground continuity.
- Furnished with covers.
- General purpose wiring.
- Function as sealing fittings when used with sealing covers (see NEC for restrictions).
- Internally threaded body with externally threaded cover.
- Covers have pry notches for bar or wrench.
- Accommodate sealing, dome, hub and union hub covers, and canopies.
- Standard O-rings provide raintight fit. NEMA 3, 4.
- Internal ground screw standard.
- Smooth, rounded integral bushing in each hub type box protects conductor insulation.

### Standard Materials

- Body: malleable iron or copperfree (4/10 of 1% max.) aluminum
- Cover: copperfree (4/10 of 1% max.) aluminum

### Standard Finishes

- Malleable iron bodies and covers: triple-coat — (1) zinc electroplate, (2) chromate, and (3) epoxy powder coat
- Aluminum bodies and covers: epoxy powder coat

### Options

- To order body without cover, add suffix **-LC** to catalog number.
- For malleable iron body and cover, add suffix **-M**.
- PVC coating available on specified products. Add suffix **-PVC** to catalog number. To add PVC coating to items not specified, contact your local sales representative.

### Certifications and Compliances

- Class 1, Zone 1 & 2 IIA & IIB
- UL Listed: E10444
- CSA Standard: C22.2 No. 25, C22.2 No. 30
- CSA Certified: 013017



♦ In Class I, Division 1, Group B atmospheres, all conduit runs must have a sealing fitting (not supplied) field-installed adjacent to the enclosure.

# GR Conduit Outlet Boxes

## Explosionproof, Dust-Ignitionproof

UNILETS® for use with Threaded Metal Conduit. Furnished with Internal Ground Screw and O-Ring.

Class I, Division 1 and 2, Groups B♦, C, D  
 Class II, Division 1 and 2, Groups E, F, G  
 Class III  
 NEMA 3, 4

Enclosures and Junction Boxes

ENCLOSURES AND JUNCTION BOXES: HAZARDOUS LOCATION CONDUIT OUTLET BOXES

| Hub Type                                                                            | Conduit Size (Inches) | Cover Opening Inches/Millimeters | Volume Capacity in <sup>3</sup> /dm <sup>3</sup> | Form Number <sup>③</sup> | Catalog Number <sup>①</sup>                          |                                   |
|-------------------------------------------------------------------------------------|-----------------------|----------------------------------|--------------------------------------------------|--------------------------|------------------------------------------------------|-----------------------------------|
|                                                                                     |                       |                                  |                                                  |                          | Malleable Iron <sup>②</sup> Body With Aluminum Cover | Aluminum Body with Aluminum Cover |
|    | 1/2                   | 3.38/85.9                        | 18.0/.29                                         | 1                        | GRE50                                                | GRE50-A                           |
|                                                                                     | 3/4                   | 3.38/85.9                        | 18.0/.29                                         | 1                        | GRE75                                                | GRE75-A                           |
|                                                                                     | 1                     | 3.38/85.9                        | 18.0/.29                                         | 1                        | GRE100                                               | GRE100-A                          |
|                                                                                     | 1-1/4                 | 3.94/100.1                       | 31.0/.51                                         | 2                        | GRE125                                               | GRE125-A                          |
|                                                                                     | 1-1/2                 | 4.88/124.0                       | 72.0/1.18                                        | 3                        | GRE150                                               | GRE150-A                          |
|    | 1/2                   | 3.38/85.9                        | 18.0/.29                                         | 1                        | GRC50                                                | GRC50-A                           |
|                                                                                     | 3/4                   | 3.38/85.9                        | 18.0/.29                                         | 1                        | GRC75                                                | GRC75-A                           |
|                                                                                     | 1                     | 3.38/85.9                        | 18.0/.29                                         | 1                        | GRC100                                               | GRC100-A                          |
|                                                                                     | 1-1/4                 | 3.94/100.1                       | 31.0/.51                                         | 2                        | GRC125                                               | GRC125-A                          |
|                                                                                     | 1-1/2                 | 4.88/124.0                       | 72.0/1.18                                        | 3                        | GRC150                                               | GRC150-A                          |
|                                                                                     | 2                     | 4.88/124.0                       | 76.0/1.25                                        | 3                        | GRC200                                               | GRC200-A                          |
|   | 1/2                   | 3.38/85.9                        | 18.0/.29                                         | 1                        | GRL50                                                | GRL50-A                           |
|                                                                                     | 3/4                   | 3.38/85.9                        | 18.0/.29                                         | 1                        | GRL75                                                | GRL75-A                           |
|                                                                                     | 1                     | 3.38/85.9                        | 18.0/.29                                         | 1                        | GRL100                                               | GRL100-A                          |
|                                                                                     | 1-1/4                 | 3.94/100.1                       | 31.0/.51                                         | 2                        | GRL125                                               | GRL125-A                          |
|                                                                                     | 1-1/2                 | 4.88/124.0                       | 72.0/1.18                                        | 3                        | GRL150                                               | GRL150-A                          |
|                                                                                     | 2                     | 4.88/124.0                       | 76.0/1.25                                        | 3                        | GRL200                                               | GRL200-A                          |
|  | 1/2                   | 3.38/85.9                        | 18.0/.29                                         | 1                        | GRLB50                                               | GRLB50-A                          |
|                                                                                     | 3/4                   | 3.38/85.9                        | 18.0/.29                                         | 1                        | GRLB75                                               | GRLB75-A                          |
|                                                                                     | 1                     | 3.38/85.9                        | 18.0/.29                                         | 1                        | GRLB100                                              | GRLB100-A                         |
|                                                                                     | 1-1/4                 | 3.94/100.1                       | 31.0/.51                                         | 2                        | GRLB125                                              | GRLB125-A                         |
|                                                                                     | 1-1/2                 | 4.88/124.0                       | 72.0/1.18                                        | 3                        | GRLB150                                              | GRLB150-A                         |
|                                                                                     | 2                     | 4.88/124.0                       | 76.0/1.25                                        | 3                        | GRLB200                                              | GRLB200-A                         |
|  | 1/2                   | 3.38/85.9                        | 18.0/.29                                         | 1                        | GRN50                                                | GRN50-A                           |
|                                                                                     | 3/4                   | 3.38/85.9                        | 18.0/.29                                         | 1                        | GRN75                                                | GRN75-A                           |
|                                                                                     | 1                     | 3.38/85.9                        | 18.0/.29                                         | 1                        | GRN100                                               | GRN100-A                          |
|                                                                                     | 1-1/4                 | 3.94/100.1                       | 31.0/.51                                         | 2                        | GRN125                                               | GRN125-A                          |
|                                                                                     | 1-1/2                 | 4.88/124.0                       | 72.0/1.18                                        | 3                        | GRN150                                               | GRN150-A                          |
|  | 1/2                   | 3.38/85.9                        | 18.0/.29                                         | 1                        | GRT50                                                | GRT50-A                           |
|                                                                                     | 3/4                   | 3.38/85.9                        | 18.0/.29                                         | 1                        | GRT75                                                | GRT75-A                           |
|                                                                                     | 1                     | 3.38/85.9                        | 18.0/.29                                         | 1                        | GRT100                                               | GRT100-A                          |
|                                                                                     | 1-1/4                 | 3.94/100.1                       | 31.0/.51                                         | 2                        | GRT125                                               | GRT125-A                          |
|                                                                                     | 1-1/2                 | 4.88/124.0                       | 72.0/1.18                                        | 3                        | GRT150                                               | GRT150-A                          |
|                                                                                     | 2                     | 4.88/124.0                       | 76.0/1.25                                        | 3                        | GRT200                                               | GRT200-A                          |
|  | 1/2                   | 3.38/85.9                        | 18.0/.29                                         | 1                        | GRX50                                                | GRX50-A                           |
|                                                                                     | 3/4                   | 3.38/85.9                        | 18.0/.29                                         | 1                        | GRX75                                                | GRX75-A                           |
|                                                                                     | 1                     | 3.38/85.9                        | 18.0/.29                                         | 1                        | GRX100                                               | GRX100-A                          |
|                                                                                     | 1-1/4                 | 3.94/100.1                       | 31.0/.51                                         | 2                        | GRX125                                               | GRX125-A                          |
|                                                                                     | 1-1/2                 | 4.88/124.0                       | 72.0/1.18                                        | 3                        | GRX150                                               | GRX150-A                          |
|                                                                                     | 2                     | 4.88/124.0                       | 76.0/1.25                                        | 3                        | GRX200                                               | GRX200-A                          |

♦ In Class I, Division 1, Group B atmospheres, all conduit runs must have a sealing fitting (not supplied) field-installed adjacent to the enclosure.

① Other covers available—see GR and GRF Conduit Outlet Box Covers page. Order separately.

② For malleable iron body and cover, add suffix **-M**.

③ Form number designates body and matching cover sizes. To order body without cover, add suffix **-LC** to catalog number.

④ PVC coating available, add suffix **-PVC** to catalog number.

# GR Conduit Outlet Boxes

## Explosionproof, Dust-Ignitionproof

UNILETS® for use with Threaded Metal Conduit. Furnished with Internal Ground Screw and O-Ring.

Class I, Division 1 and 2, Groups B♦, C, D  
 Class II, Division 1 and 2, Groups E, F, G  
 Class III  
 NEMA 3, 4

| Hub Type                                                                          | Conduit Size (Inches) | Cover Opening Inches/Millimeters | Volume Capacity in <sup>3</sup> /dm <sup>3</sup> | Form Number ③ | Catalog Number ①                          |                                   |
|-----------------------------------------------------------------------------------|-----------------------|----------------------------------|--------------------------------------------------|---------------|-------------------------------------------|-----------------------------------|
|                                                                                   |                       |                                  |                                                  |               | Malleable Iron ② Body With Aluminum Cover | Aluminum Body with Aluminum Cover |
|  | 1/2                   | 3.38/85.9                        | 18.0/0.29                                        | 1             | GRCA50                                    | GRCA50-A                          |
|                                                                                   | 3/4                   | 3.38/85.9                        | 18.0/0.29                                        | 1             | GRCA75                                    | GRCA75-A                          |
|  | 1/2                   | 3.38/85.9                        | 18.0/0.29                                        | 1             | GRLA50                                    | GRLA50-A                          |
|                                                                                   | 3/4                   | 3.38/85.9                        | 18.0/0.29                                        | 1             | GRLA75                                    | GRLA75-A                          |
|  | 1/2                   | 3.38/85.9                        | 18.0/0.29                                        | 1             | GRTA50                                    | GRTA50-A                          |
|                                                                                   | 3/4                   | 3.38/85.9                        | 18.0/0.29                                        | 1             | GRTA75                                    | GRTA75-A                          |

### Dimensions

| Hub Size (Inches)               | Dimensions in Inches/Millimeters |            |            |           |           |            |           |
|---------------------------------|----------------------------------|------------|------------|-----------|-----------|------------|-----------|
|                                 | A                                | B          | C          | D         | E         | F          | G         |
| <b>GR Series, Form 1</b>        |                                  |            |            |           |           |            |           |
| 1/2                             | 3.75/95.3                        | 2.44/62    | 2.88/73.2  | 0.75/19.1 | 0.81/20.6 | 2.25/57.2  | 1.25/31.8 |
| 3/4                             | 3.75/95.3                        | 2.44/62    | 2.88/73.2  | 0.75/19.1 | 0.81/20.6 | 2.25/57.2  | 1.25/31.8 |
| 1                               | 3.75/95.3                        | 2.44/62    | 2.88/73.2  | 0.94/23.9 | 0.94/23.9 | 2.25/57.2  | 1.06/26.9 |
| <b>GR Series, Forms 2 and 3</b> |                                  |            |            |           |           |            |           |
| 1-1/4                           | 4.50/114.3                       | 2.69/68.3  | 3.56/90.4  | 1.19/30.2 | 0.88/22.4 | 2.75/69.9  | 1.13/28.7 |
| 1-1/2                           | 5.75/146.1                       | 3.75/95.3  | 4.81/122.2 | 1.38/35.1 | 0.94/23.9 | 4.06/103.1 | 1.50/38.1 |
| 2                               | 5.75/146.1                       | 4.00/101.6 | 5.06/128.5 | 1.63/41.4 | 1/25.4    | 4.25/108.0 | 1.25/31.8 |





♦ In Class I, Division 1, Group B atmospheres, all conduit runs must have a sealing fitting (not supplied) field-installed adjacent to the enclosure.  
 ① Other covers available—see GR and GRF Conduit Outlet Box Covers page. Order separately.  
 ② For malleable iron body and cover, add suffix **-M**.  
 ③ Form number designates body and matching cover sizes. To order body without cover, add suffix **-LC** to catalog number.

# GRF Flanged Conduit Outlet Boxes





## Explosionproof, Dust-Ignitionproof

UNILETS® for use with Threaded Metal Conduit. Furnished with Internal Ground Screw and O-Ring.

Class I, Division 1 and 2, Groups B♦, C, D  
 Class II, Division 1 and 2, Groups E, F, G  
 Class III  
 NEMA 3, 4

Enclosures and Junction Boxes

ENCLOSURES AND JUNCTION BOXES: HAZARDOUS LOCATION CONDUIT OUTLET BOXES

|                                                                                    | Hub Type | Conduit Size (Inches) | Cover Opening Inches/Millimeters | Capacity in <sup>3</sup> /dm <sup>3</sup> | Form Number ③ | Catalog Number ①                          |                                   |
|------------------------------------------------------------------------------------|----------|-----------------------|----------------------------------|-------------------------------------------|---------------|-------------------------------------------|-----------------------------------|
|                                                                                    |          |                       |                                  |                                           |               | Malleable Iron ② Body With Aluminum Cover | Aluminum Body with Aluminum Cover |
|   | GRFC     | 1/2                   | 3.38/85.9                        | 18.0/0.29                                 | 1             | GRFC50                                    | GRFC50-A                          |
|                                                                                    |          | 3/4                   | 3.38/85.9                        | 18.0/0.29                                 | 1             | GRFC75                                    | GRFC75-A                          |
|                                                                                    |          | 1                     | 3.38/85.9                        | 18.0/0.29                                 | 1             | GRFC100                                   | GRFC100-A                         |
|   | GRFL     | 1/2                   | 3.38/85.9                        | 18.0/0.29                                 | 1             | GRFL50                                    | GRFL50-A                          |
|                                                                                    |          | 3/4                   | 3.38/85.9                        | 18.0/0.29                                 | 1             | GRFL75                                    | GRFL75-A                          |
|                                                                                    |          | 1                     | 3.38/85.9                        | 18.0/0.29                                 | 1             | GRFL100                                   | GRFL100-A                         |
|   | GRFT     | 1/2                   | 3.38/85.9                        | 18.0/0.29                                 | 1             | GRFT50                                    | GRFT50-A                          |
|                                                                                    |          | 3/4                   | 3.38/85.9                        | 18.0/0.29                                 | 1             | GRFT75                                    | GRFT75-A                          |
|                                                                                    |          | 1                     | 3.38/85.9                        | 18.0/0.29                                 | 1             | GRFT100                                   | GRFT100-A                         |
|  | GRFX     | 1/2                   | 3.38/85.9                        | 18.0/0.29                                 | 1             | GRFX50                                    | GRFX50-A                          |
|                                                                                    |          | 3/4                   | 3.38/85.9                        | 18.0/0.29                                 | 1             | GRFX75                                    | GRFX75-A                          |
|                                                                                    |          | 1                     | 3.38/85.9                        | 18.0/0.29                                 | 1             | GRFX100                                   | GRFX100-A                         |

### Dimensions

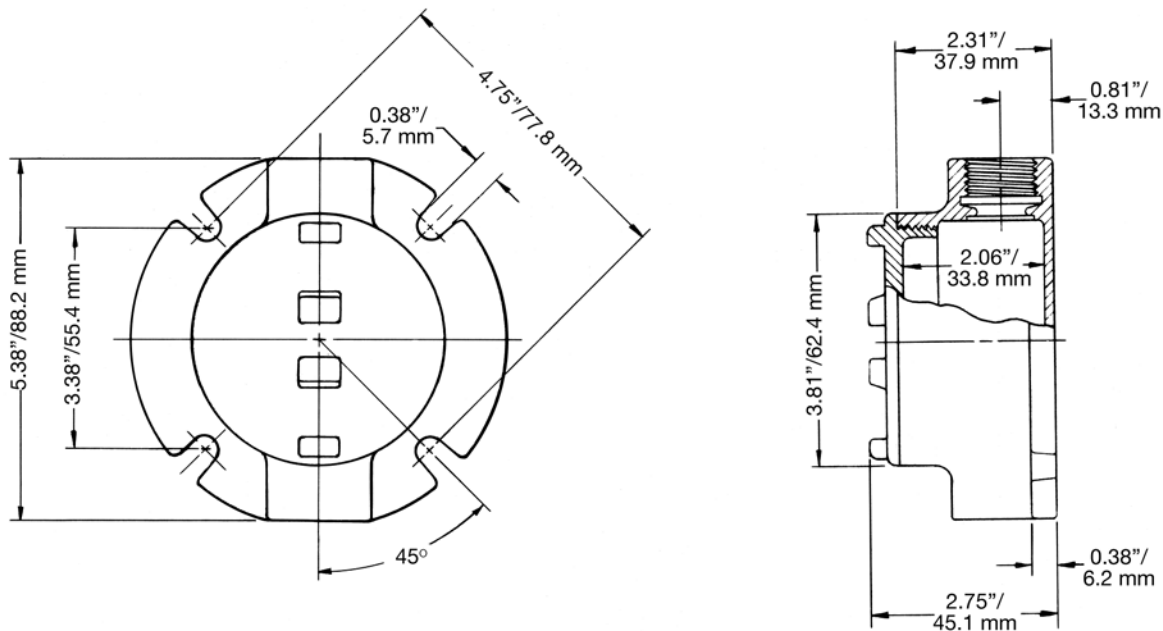

♦ In Class I, Division 1, Group B atmospheres, all conduit runs must have a sealing fitting (not supplied) field-installed adjacent to the enclosure.

① Other covers available—see GR and GRF Conduit Outlet Box Covers page. Order separately

② For malleable iron body and cover, add suffix **-M**.









③ Form number designates body and matching cover sizes. To order body without cover, add suffix **-LC** to catalog number.

# GR and GRF Conduit Outlet Box Covers

## Explosionproof, Dust-Ignitionproof

Covers and O-rings Fit Bodies with Corresponding Form Numbers.

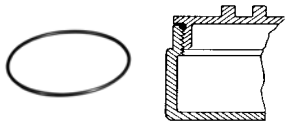
Class I, Division 1 and 2, Groups B♦, C, D  
 Class II, Division 1 and 2, Groups E, F, G  
 Class III  
 NEMA 3, 4

|                                                                                                                                                                                                   | Hub Type                                                                                                               | Cover Opening<br>Inches/Millimeters | Fixture Stem Size<br>Inches/Millimeters | Form<br>Number ① | Catalog Number |           |
|---------------------------------------------------------------------------------------------------------------------------------------------------------------------------------------------------|------------------------------------------------------------------------------------------------------------------------|-------------------------------------|-----------------------------------------|------------------|----------------|-----------|
|                                                                                                                                                                                                   |                                                                                                                        |                                     |                                         |                  | Malleable Iron | Aluminum  |
|                                                                                                                  | Surface ②                                                                                                              | 3.38/85.9                           |                                         | 1                | GRK-1M         | GRK-1     |
|                                                                                                                                                                                                   |                                                                                                                        | 3.94/100.1                          |                                         | 2                | GRK-2M         | GRK-2     |
|                                                                                                                                                                                                   |                                                                                                                        | 4.88/124.0                          |                                         | 3                | GRK-3M         | GRK-3     |
|                                                                                                                  | Sealing ②                                                                                                              | 3.38/85.9                           |                                         | 1                | GRK-1SC        | GRK-1SC-A |
|                                                                                                                                                                                                   |                                                                                                                        | 3.94/100.1                          |                                         | 2                | GRK-2SC        | GRK-2SC-A |
|                                                                                                                                                                                                   |                                                                                                                        | 4.88/124.0                          |                                         | 3                | GRK-3SC        | GRK-3SC-A |
|                                                                                                                  | 2" Deep Dome<br><i>UL Listed: E185964</i>                                                                              | 3.38/85.9                           |                                         | 1                | —              | GRK-1DC   |
|                                                                                                                 | Union Hub                                                                                                              | 3.38/85.9                           | 0.75/19.1                               | 1                | GRK-75U        | GRK-75UA  |
|                                                                                                                | Hub                                                                                                                    | 3.38/85.9                           | 0.50/12.7                               | 1                | GRK-50         | GRK50-A   |
|                                                                                                                                                                                                   |                                                                                                                        | 3.38/85.9                           | 0.75/19.1                               | 1                | GRK-75         | GRK75-A   |
|                                                                                                                | Canopy<br>Length 4-1/2"                                                                                                | 3.38/85.9                           | 0.50/12.7                               | 1                | GRK-50C        | —         |
|                                                                                                                                                                                                   |                                                                                                                        | 3.38/85.9                           | 0.75/19.1                               | 1                | GRK-75C        | —         |
|                                                                                                                                                                                                   |                                                                                                                        | 3.38/85.9                           | 1.00/25.4                               | 1                | GRK-100C       | —         |
|                                                                                                                                                                                                   |                                                                                                                        |                                     |                                         |                  | Catalog Number |           |
|                                                                                                                | <b>O-Rings — Buna-N</b>                                                                                                |                                     |                                         |                  |                |           |
|                                                                                                                                                                                                   | Provide Raintight fit when used on following series:<br>GR (Forms 1, 2 and 3), GRF (Form 1), GRH, and GRU<br>(Form 1). |                                     |                                         | 1                | GRG-1          |           |
|                                                                                                                                                                                                   |                                                                                                                        |                                     |                                         | 2                | GRG-2          |           |
|                                                                                                                                                                                                   |                                                                                                                        |                                     | 3                                       | GRG-3            |                |           |
| <b>GRTB Terminal Strip</b>                                                                                                                                                                        |                                                                                                                        |                                     |                                         |                  |                |           |
| <i>For use in standard GR series boxes Weidmuller type MK terminal block ③ with wire range of #22-#12 AWG. Mounts on 2 predrilled and tapped standard holes (furnished in internal GR boxes).</i> |                                                                                                                        |                                     |                                         |                  |                |           |
|                                                                                                                | 6 position terminal block kit                                                                                          |                                     |                                         | 1+2              | GRTB6-12       |           |
|                                                                                                                                                                                                   | 6 position terminal block kit                                                                                          |                                     |                                         | 3                | GRTB6-3        |           |
|                                                                                                                                                                                                   | 12 position terminal block kit                                                                                         |                                     |                                         | 3                | GRTB12-3       |           |

♦ In Class I, Division 1, Group B atmospheres, all conduit runs must have a sealing fitting (not supplied) field-installed adjacent to the enclosure.

① Form numbers designate cover and matching body sizes.

② PVC coating available, add suffix **-PVC** to catalog number.

③ Terminal block is UL listed for 300 Volt, 25 Amp. CSA certified for 300 Volt, 13 Amp.

# GR and GRF Conduit Outlet Boxes

## Explosionproof, Dust-Ignitionproof

UNILETS® for use with Threaded Metal Conduit. Furnished with Internal Ground Screw and O-Ring.

Class I, Division 1 and 2, Groups B♦, C, D  
Class II, Division 1 and 2, Groups E, F, G  
Class III  
NEMA 3, 4

### Applications

- Complies with a wide range of classified area requirements.
- Corrosion-resistant: ideal indoors or out.
- For pulling of wires.
- Connect conduit lengths and change direction of conduit runs.
- Provide access for maintenance.

### Features

- GR boxes offers ten hub arrangements.
- GRF boxes have integral mounting flange.
- Malleable iron bodies have high tensile strength, ductility and provides great resistance to corrosion, impact, and shock.
- Accurately tapped, tapered hub threads for tight, rigid joints and ground continuity.
- Furnished with covers.
- General purpose wiring.
- Function as sealing fittings when used with sealing covers (see NEC for restrictions).
- Internally threaded body with externally threaded cover.
- Covers have pry notches for bar or wrench.
- Accommodate sealing, dome, hub and union hub covers, and canopies.
- Standard O-rings provide raintight fit. NEMA 3, 4.
- Internal ground screw standard.
- Smooth, rounded integral bushing in each hub type box protects conductor insulation.

### Standard Materials

- Body: malleable iron or copperfree (4/10 of 1% max.) aluminum
- Cover: copperfree (4/10 of 1% max.) aluminum

### Standard Finishes

- Malleable iron bodies and covers: triple-coat — (1) zinc electroplate, (2) chromate, and (3) epoxy powder coat
- Aluminum bodies and covers: epoxy powder coat

### Options

- To order body without cover, add suffix **-LC** to catalog number.
- For malleable iron body and cover, add suffix **-M**.
- PVC coating available on specified products. Add suffix **-PVC** to catalog number. To add PVC coating to items not specified, contact your local sales representative.

### Certifications and Compliances

- Class 1, Zone 1 & 2 IIA & IIB
- UL Listed: E10444
- CSA Standard: C22.2 No. 25, C22.2 No. 30
- CSA Certified: 013017



♦ In Class I, Division 1, Group B atmospheres, all conduit runs must have a sealing fitting (not supplied) field-installed adjacent to the enclosure.

# GR Conduit Outlet Boxes

## Explosionproof, Dust-Ignitionproof

UNILETS® for use with Threaded Metal Conduit. Furnished with Internal Ground Screw and O-Ring.

Class I, Division 1 and 2, Groups B♦, C, D  
 Class II, Division 1 and 2, Groups E, F, G  
 Class III  
 NEMA 3, 4

Enclosures and Junction Boxes

ENCLOSURES AND JUNCTION BOXES: HAZARDOUS LOCATION CONDUIT OUTLET BOXES

|                                                                                     | Hub Type         | Conduit Size (Inches)                                                               | Cover Opening Inches/Millimeters | Volume Capacity in <sup>3</sup> /dm <sup>3</sup> | Form Number <sup>③</sup> | Catalog Number <sup>①</sup>                          |                                   |
|-------------------------------------------------------------------------------------|------------------|-------------------------------------------------------------------------------------|----------------------------------|--------------------------------------------------|--------------------------|------------------------------------------------------|-----------------------------------|
|                                                                                     |                  |                                                                                     |                                  |                                                  |                          | Malleable Iron <sup>②</sup> Body With Aluminum Cover | Aluminum Body with Aluminum Cover |
|    | GRE              | 1/2                                                                                 | 3.38/85.9                        | 18.0/29                                          | 1                        | GRE50                                                | GRE50-A                           |
|                                                                                     |                  | 3/4                                                                                 | 3.38/85.9                        | 18.0/29                                          | 1                        | GRE75                                                | GRE75-A                           |
|                                                                                     |                  | 1                                                                                   | 3.38/85.9                        | 18.0/29                                          | 1                        | GRE100                                               | GRE100-A                          |
|                                                                                     |                  | 1-1/4                                                                               | 3.94/100.1                       | 31.0/51                                          | 2                        | GRE125                                               | GRE125-A                          |
|                                                                                     |                  | 1-1/2                                                                               | 4.88/124.0                       | 72.0/1.18                                        | 3                        | GRE150                                               | GRE150-A                          |
|    | GRC <sup>④</sup> | 1/2                                                                                 | 3.38/85.9                        | 18.0/29                                          | 1                        | GRC50                                                | GRC50-A                           |
|                                                                                     |                  | 3/4                                                                                 | 3.38/85.9                        | 18.0/29                                          | 1                        | GRC75                                                | GRC75-A                           |
|                                                                                     |                  | 1                                                                                   | 3.38/85.9                        | 18.0/29                                          | 1                        | GRC100                                               | GRC100-A                          |
|                                                                                     |                  | 1-1/4                                                                               | 3.94/100.1                       | 31.0/51                                          | 2                        | GRC125                                               | GRC125-A                          |
|                                                                                     |                  | 1-1/2                                                                               | 4.88/124.0                       | 72.0/1.18                                        | 3                        | GRC150                                               | GRC150-A                          |
|                                                                                     |                  | 2                                                                                   | 4.88/124.0                       | 76.0/1.25                                        | 3                        | GRC200                                               | GRC200-A                          |
|   | GRL <sup>④</sup> | 1/2                                                                                 | 3.38/85.9                        | 18.0/29                                          | 1                        | GRL50                                                | GRL50-A                           |
|                                                                                     |                  | 3/4                                                                                 | 3.38/85.9                        | 18.0/29                                          | 1                        | GRL75                                                | GRL75-A                           |
|                                                                                     |                  | 1                                                                                   | 3.38/85.9                        | 18.0/29                                          | 1                        | GRL100                                               | GRL100-A                          |
|                                                                                     |                  | 1-1/4                                                                               | 3.94/100.1                       | 31.0/51                                          | 2                        | GRL125                                               | GRL125-A                          |
|                                                                                     |                  | 1-1/2                                                                               | 4.88/124.0                       | 72.0/1.18                                        | 3                        | GRL150                                               | GRL150-A                          |
|                                                                                     |                  | 2                                                                                   | 4.88/124.0                       | 76.0/1.25                                        | 3                        | GRL200                                               | GRL200-A                          |
|                                                                                     |                  |  | GRLB <sup>④</sup>                | 1/2                                              | 3.38/85.9                | 18.0/29                                              | 1                                 |
| 3/4                                                                                 | 3.38/85.9        |                                                                                     |                                  | 18.0/29                                          | 1                        | GRLB75                                               | GRLB75-A                          |
| 1                                                                                   | 3.38/85.9        |                                                                                     |                                  | 18.0/29                                          | 1                        | GRLB100                                              | GRLB100-A                         |
| 1-1/4                                                                               | 3.94/100.1       |                                                                                     |                                  | 31.0/51                                          | 2                        | GRLB125                                              | GRLB125-A                         |
| 1-1/2                                                                               | 4.88/124.0       |                                                                                     |                                  | 72.0/1.18                                        | 3                        | GRLB150                                              | GRLB150-A                         |
| 2                                                                                   | 4.88/124.0       |                                                                                     |                                  | 76.0/1.25                                        | 3                        | GRLB200                                              | GRLB200-A                         |
|  | GRN <sup>④</sup> |                                                                                     |                                  | 1/2                                              | 3.38/85.9                | 18.0/29                                              | 1                                 |
|                                                                                     |                  | 3/4                                                                                 | 3.38/85.9                        | 18.0/29                                          | 1                        | GRN75                                                | GRN75-A                           |
|                                                                                     |                  | 1                                                                                   | 3.38/85.9                        | 18.0/29                                          | 1                        | GRN100                                               | GRN100-A                          |
|                                                                                     |                  | 1-1/4                                                                               | 3.94/100.1                       | 31.0/51                                          | 2                        | GRN125                                               | GRN125-A                          |
|                                                                                     |                  | 1-1/2                                                                               | 4.88/124.0                       | 72.0/1.18                                        | 3                        | GRN150                                               | GRN150-A                          |
|  | GRT <sup>④</sup> | 1/2                                                                                 | 3.38/85.9                        | 18.0/29                                          | 1                        | GRT50                                                | GRT50-A                           |
|                                                                                     |                  | 3/4                                                                                 | 3.38/85.9                        | 18.0/29                                          | 1                        | GRT75                                                | GRT75-A                           |
|                                                                                     |                  | 1                                                                                   | 3.38/85.9                        | 18.0/29                                          | 1                        | GRT100                                               | GRT100-A                          |
|                                                                                     |                  | 1-1/4                                                                               | 3.94/100.1                       | 31.0/51                                          | 2                        | GRT125                                               | GRT125-A                          |
|                                                                                     |                  | 1-1/2                                                                               | 4.88/124.0                       | 72.0/1.18                                        | 3                        | GRT150                                               | GRT150-A                          |
|                                                                                     |                  | 2                                                                                   | 4.88/124.0                       | 76.0/1.25                                        | 3                        | GRT200                                               | GRT200-A                          |
|  | GRX <sup>④</sup> | 1/2                                                                                 | 3.38/85.9                        | 18.0/29                                          | 1                        | GRX50                                                | GRX50-A                           |
|                                                                                     |                  | 3/4                                                                                 | 3.38/85.9                        | 18.0/29                                          | 1                        | GRX75                                                | GRX75-A                           |
|                                                                                     |                  | 1                                                                                   | 3.38/85.9                        | 18.0/29                                          | 1                        | GRX100                                               | GRX100-A                          |
|                                                                                     |                  | 1-1/4                                                                               | 3.94/100.1                       | 31.0/51                                          | 2                        | GRX125                                               | GRX125-A                          |
|                                                                                     |                  | 1-1/2                                                                               | 4.88/124.0                       | 72.0/1.18                                        | 3                        | GRX150                                               | GRX150-A                          |
|                                                                                     |                  | 2                                                                                   | 4.88/124.0                       | 76.0/1.25                                        | 3                        | GRX200                                               | GRX200-A                          |

♦ In Class I, Division 1, Group B atmospheres, all conduit runs must have a sealing fitting (not supplied) field-installed adjacent to the enclosure.

① Other covers available—see GR and GRF Conduit Outlet Box Covers page. Order separately.

② For malleable iron body and cover, add suffix **-M**.

③ Form number designates body and matching cover sizes. To order body without cover, add suffix **-LC** to catalog number.

④ PVC coating available, add suffix **-PVC** to catalog number.

# GR Conduit Outlet Boxes

## Explosionproof, Dust-Ignitionproof

UNILETS® for use with Threaded Metal Conduit. Furnished with Internal Ground Screw and O-Ring.

Class I, Division 1 and 2, Groups B♦, C, D  
 Class II, Division 1 and 2, Groups E, F, G  
 Class III  
 NEMA 3, 4

| Hub Type                                                                          | Conduit Size (Inches) | Cover Opening Inches/Millimeters | Volume Capacity in <sup>3</sup> /dm <sup>3</sup> | Form Number ③ | Catalog Number ①                          |                                   |
|-----------------------------------------------------------------------------------|-----------------------|----------------------------------|--------------------------------------------------|---------------|-------------------------------------------|-----------------------------------|
|                                                                                   |                       |                                  |                                                  |               | Malleable Iron ② Body With Aluminum Cover | Aluminum Body with Aluminum Cover |
|  | 1/2                   | 3.38/85.9                        | 18.0/0.29                                        | 1             | GRCA50                                    | GRCA50-A                          |
|                                                                                   | 3/4                   | 3.38/85.9                        | 18.0/0.29                                        | 1             | GRCA75                                    | GRCA75-A                          |
|  | 1/2                   | 3.38/85.9                        | 18.0/0.29                                        | 1             | GRLA50                                    | GRLA50-A                          |
|                                                                                   | 3/4                   | 3.38/85.9                        | 18.0/0.29                                        | 1             | GRLA75                                    | GRLA75-A                          |
|  | 1/2                   | 3.38/85.9                        | 18.0/0.29                                        | 1             | GRTA50                                    | GRTA50-A                          |
|                                                                                   | 3/4                   | 3.38/85.9                        | 18.0/0.29                                        | 1             | GRTA75                                    | GRTA75-A                          |

### Dimensions

| Hub Size (Inches)               | Dimensions in Inches/Millimeters |            |            |           |           |            |           |
|---------------------------------|----------------------------------|------------|------------|-----------|-----------|------------|-----------|
|                                 | A                                | B          | C          | D         | E         | F          | G         |
| <b>GR Series, Form 1</b>        |                                  |            |            |           |           |            |           |
| 1/2                             | 3.75/95.3                        | 2.44/62    | 2.88/73.2  | 0.75/19.1 | 0.81/20.6 | 2.25/57.2  | 1.25/31.8 |
| 3/4                             | 3.75/95.3                        | 2.44/62    | 2.88/73.2  | 0.75/19.1 | 0.81/20.6 | 2.25/57.2  | 1.25/31.8 |
| 1                               | 3.75/95.3                        | 2.44/62    | 2.88/73.2  | 0.94/23.9 | 0.94/23.9 | 2.25/57.2  | 1.06/26.9 |
| <b>GR Series, Forms 2 and 3</b> |                                  |            |            |           |           |            |           |
| 1-1/4                           | 4.50/114.3                       | 2.69/68.3  | 3.56/90.4  | 1.19/30.2 | 0.88/22.4 | 2.75/69.9  | 1.13/28.7 |
| 1-1/2                           | 5.75/146.1                       | 3.75/95.3  | 4.81/122.2 | 1.38/35.1 | 0.94/23.9 | 4.06/103.1 | 1.50/38.1 |
| 2                               | 5.75/146.1                       | 4.00/101.6 | 5.06/128.5 | 1.63/41.4 | 1/25.4    | 4.25/108.0 | 1.25/31.8 |





♦ In Class I, Division 1, Group B atmospheres, all conduit runs must have a sealing fitting (not supplied) field-installed adjacent to the enclosure.  
 ① Other covers available—see GR and GRF Conduit Outlet Box Covers page. Order separately.  
 ② For malleable iron body and cover, add suffix **-M**.  
 ③ Form number designates body and matching cover sizes. To order body without cover, add suffix **-LC** to catalog number.



# GRF Flanged Conduit Outlet Boxes

## Explosionproof, Dust-Ignitionproof

UNILETS® for use with Threaded Metal Conduit. Furnished with Internal Ground Screw and O-Ring.

Class I, Division 1 and 2, Groups B♦, C, D  
 Class II, Division 1 and 2, Groups E, F, G  
 Class III  
 NEMA 3, 4

Enclosures and Junction Boxes

ENCLOSURES AND JUNCTION BOXES: HAZARDOUS LOCATION CONDUIT OUTLET BOXES

|                                                                                    | Hub Type | Conduit Size (Inches) | Cover Opening Inches/Millimeters | Capacity in <sup>3</sup> /dm <sup>3</sup> | Form Number ③ | Catalog Number ①                          |                                   |
|------------------------------------------------------------------------------------|----------|-----------------------|----------------------------------|-------------------------------------------|---------------|-------------------------------------------|-----------------------------------|
|                                                                                    |          |                       |                                  |                                           |               | Malleable Iron ② Body With Aluminum Cover | Aluminum Body with Aluminum Cover |
|   | GRFC     | 1/2                   | 3.38/85.9                        | 18.0/0.29                                 | 1             | GRFC50                                    | GRFC50-A                          |
|                                                                                    |          | 3/4                   | 3.38/85.9                        | 18.0/0.29                                 | 1             | GRFC75                                    | GRFC75-A                          |
|                                                                                    |          | 1                     | 3.38/85.9                        | 18.0/0.29                                 | 1             | GRFC100                                   | GRFC100-A                         |
|   | GRFL     | 1/2                   | 3.38/85.9                        | 18.0/0.29                                 | 1             | GRFL50                                    | GRFL50-A                          |
|                                                                                    |          | 3/4                   | 3.38/85.9                        | 18.0/0.29                                 | 1             | GRFL75                                    | GRFL75-A                          |
|                                                                                    |          | 1                     | 3.38/85.9                        | 18.0/0.29                                 | 1             | GRFL100                                   | GRFL100-A                         |
|   | GRFT     | 1/2                   | 3.38/85.9                        | 18.0/0.29                                 | 1             | GRFT50                                    | GRFT50-A                          |
|                                                                                    |          | 3/4                   | 3.38/85.9                        | 18.0/0.29                                 | 1             | GRFT75                                    | GRFT75-A                          |
|                                                                                    |          | 1                     | 3.38/85.9                        | 18.0/0.29                                 | 1             | GRFT100                                   | GRFT100-A                         |
|  | GRFX     | 1/2                   | 3.38/85.9                        | 18.0/0.29                                 | 1             | GRFX50                                    | GRFX50-A                          |
|                                                                                    |          | 3/4                   | 3.38/85.9                        | 18.0/0.29                                 | 1             | GRFX75                                    | GRFX75-A                          |
|                                                                                    |          | 1                     | 3.38/85.9                        | 18.0/0.29                                 | 1             | GRFX100                                   | GRFX100-A                         |

### Dimensions



♦ In Class I, Division 1, Group B atmospheres, all conduit runs must have a sealing fitting (not supplied) field-installed adjacent to the enclosure.

① Other covers available—see GR and GRF Conduit Outlet Box Covers page. Order separately

② For malleable iron body and cover, add suffix **-M**.

③ Form number designates body and matching cover sizes. To order body without cover, add suffix **-LC** to catalog number.

# GR and GRF Conduit Outlet Box Covers

## Explosionproof, Dust-Ignitionproof

Covers and O-rings Fit Bodies with Corresponding Form Numbers.

Class I, Division 1 and 2, Groups B♦, C, D  
 Class II, Division 1 and 2, Groups E, F, G  
 Class III  
 NEMA 3, 4

|                                                                                                                                                                                                   | Hub Type                                                                                                               | Cover Opening<br>Inches/Millimeters | Fixture Stem Size<br>Inches/Millimeters | Form<br>Number ① | Catalog Number |           |
|---------------------------------------------------------------------------------------------------------------------------------------------------------------------------------------------------|------------------------------------------------------------------------------------------------------------------------|-------------------------------------|-----------------------------------------|------------------|----------------|-----------|
|                                                                                                                                                                                                   |                                                                                                                        |                                     |                                         |                  | Malleable Iron | Aluminum  |
|                                                                                                                  | Surface ②                                                                                                              | 3.38/85.9                           |                                         | 1                | GRK-1M         | GRK-1     |
|                                                                                                                                                                                                   |                                                                                                                        | 3.94/100.1                          |                                         | 2                | GRK-2M         | GRK-2     |
|                                                                                                                                                                                                   |                                                                                                                        | 4.88/124.0                          |                                         | 3                | GRK-3M         | GRK-3     |
|                                                                                                                  | Sealing ②                                                                                                              | 3.38/85.9                           |                                         | 1                | GRK-1SC        | GRK-1SC-A |
|                                                                                                                                                                                                   |                                                                                                                        | 3.94/100.1                          |                                         | 2                | GRK-2SC        | GRK-2SC-A |
|                                                                                                                                                                                                   |                                                                                                                        | 4.88/124.0                          |                                         | 3                | GRK-3SC        | GRK-3SC-A |
|                                                                                                                  | 2" Deep Dome<br><i>UL Listed: E185964</i>                                                                              | 3.38/85.9                           |                                         | 1                | —              | GRK-1DC   |
|                                                                                                                 | Union Hub                                                                                                              | 3.38/85.9                           | 0.75/19.1                               | 1                | GRK-75U        | GRK-75UA  |
|                                                                                                                | Hub                                                                                                                    | 3.38/85.9                           | 0.50/12.7                               | 1                | GRK-50         | GRK50-A   |
|                                                                                                                                                                                                   |                                                                                                                        | 3.38/85.9                           | 0.75/19.1                               | 1                | GRK-75         | GRK75-A   |
|                                                                                                                | Canopy<br>Length 4-1/2"                                                                                                | 3.38/85.9                           | 0.50/12.7                               | 1                | GRK-50C        | —         |
|                                                                                                                                                                                                   |                                                                                                                        | 3.38/85.9                           | 0.75/19.1                               | 1                | GRK-75C        | —         |
|                                                                                                                                                                                                   |                                                                                                                        | 3.38/85.9                           | 1.00/25.4                               | 1                | GRK-100C       | —         |
|                                                                                                                                                                                                   |                                                                                                                        |                                     |                                         |                  | Catalog Number |           |
|                                                                                                                | <b>O-Rings — Buna-N</b>                                                                                                |                                     |                                         |                  |                |           |
|                                                                                                                                                                                                   | Provide Raintight fit when used on following series:<br>GR (Forms 1, 2 and 3), GRF (Form 1), GRH, and GRU<br>(Form 1). |                                     |                                         | 1                | GRG-1          |           |
|                                                                                                                                                                                                   |                                                                                                                        |                                     |                                         | 2                | GRG-2          |           |
|                                                                                                                                                                                                   |                                                                                                                        |                                     | 3                                       | GRG-3            |                |           |
| <b>GRTB Terminal Strip</b>                                                                                                                                                                        |                                                                                                                        |                                     |                                         |                  |                |           |
| <i>For use in standard GR series boxes Weidmuller type MK terminal block ③ with wire range of #22-#12 AWG. Mounts on 2 predrilled and tapped standard holes (furnished in internal GR boxes).</i> |                                                                                                                        |                                     |                                         |                  |                |           |
|                                                                                                                | 6 position terminal block kit                                                                                          |                                     |                                         | 1+2              | GRTB6-12       |           |
|                                                                                                                                                                                                   | 6 position terminal block kit                                                                                          |                                     |                                         | 3                | GRTB6-3        |           |
|                                                                                                                                                                                                   | 12 position terminal block kit                                                                                         |                                     |                                         | 3                | GRTB12-3       |           |

♦ In Class I, Division 1, Group B atmospheres, all conduit runs must have a sealing fitting (not supplied) field-installed adjacent to the enclosure.

① Form numbers designate cover and matching body sizes.

② PVC coating available, add suffix **-PVC** to catalog number.

③ Terminal block is UL listed for 300 Volt, 25 Amp. CSA certified for 300 Volt, 13 Amp.