

# COOPER LIGHTING - METALUX®

## DESCRIPTION

The HBI series is an outstanding solution for high mounting height industrial or retail applications. The HBI optic has been optimized to provide maximum performance from T8 lamps. Optional uplight component is provided to enable excellent ceiling uniformity. HBI's high lumen package allows the benefits of fluorescent to be applied at high mounting heights that were traditionally exclusive to H.I.D. The primary benefits include exceptional color rendering, high system efficacy, 95% lumen maintenance, long lamp life, instant on/instant re-strike, economical dimming, and uniform brightness control. Primary applications include retail, shopping malls, light industrial, gymnasiums and recreational environments.

## SPECIFICATION FEATURES

### Construction

Full bodied steel housing with integral ballast channel adds strength, rigidity and structural protection for optical assembly.

### Electrical

The HBI comes with a standard Class P electronic ballast and twistlock lampholders. UL/cUL listed for high ambient environments up to 55°C (131°F) for all lamps and ballast combinations when used in open upright configurations. Suitable for damp locations. Optional modular power receptacle meets UL2459 and NEC 410.73 and is UL/cUL rated for make and break under load from outside the luminaire to speed maintenance.

### Finish

White enamel finish preceded by a multistage cleaning cycle, iron phosphate coating with rust inhibitor to protect against contaminants and oxidation.

### Downlight/Uplight Optics

Die formed, segmented optical design optimizes performance across three distributions. Optical choices include a narrow distribution for aisles, medium distribution for assembly and loading areas, or wide distribution for general, open area lighting. An uplight option is offered to permit ceiling uniformity and allow for ample lamp and luminaire heat dissipation. Gasketed door frame & lens assembly is optional for more demanding environments.

Catalog #		Type
Project		
Comments		Date
Prepared by		

### Options

Integral Occupancy Sensor available and provides from 600 sq. ft. (MS) up to 1250 sq. ft. (MSO) of coverage at a maximum mounting height of 40' using interchangeable lens caps provided.

### Mounting

The HBI series is suited for suspension mounting with optional wire hook and chain set or cable mounting. Single monopoint mounting is available with SPM Tong Hanger.

### Warranty

When operated in high ambient conditions, the HBI is supported by a 5 yr/55°C and 3 yr/65°C ballast warranty when used with a high power factor ballast in open, upright configurations. To maximize your warranty, the HBI should be ordered with a high power factor ballast in ambient environments that typically exceed 40°C (102°F).



## HBI SERIES

4 OR 5 T8 LAMPS

High-Bay Industrial Fluorescent Luminaire



## ENERGY DATA

Input Watts:

**EB Ballast**

432 (109), 532 (133)

**EB/Plus Ballast**

432 (145), 532 (182)

Luminaire Efficacy Rating

**LER = FL-83 (Narrow Beam)**

Catalog Number: HBI-432-N

Yearly Cost of 1000 lumens,  
3000 hrs at .08 KWH = \$2.88

\*Reference the lamp/ballast data in the Technical Section for specific lamp/ballast requirements.

\*\*Consult Pre Sales Technical Support.

LAMPS CONTAIN MERCURY. DISPOSE ACCORDING TO LOCAL, STATE OR FEDERAL LAWS

**LINEAR DISCONNECT**

Safe and convenient means of disconnecting power.

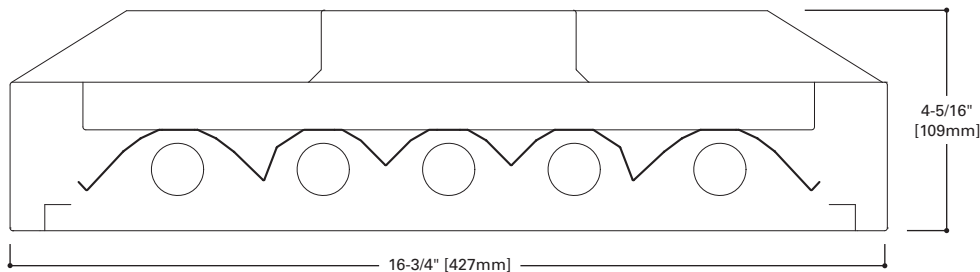

## LAMP CONFIGURATIONS

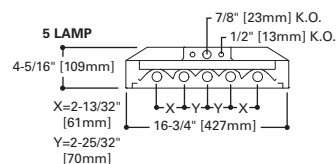
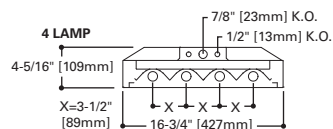

## DIMENSION TOP VIEW

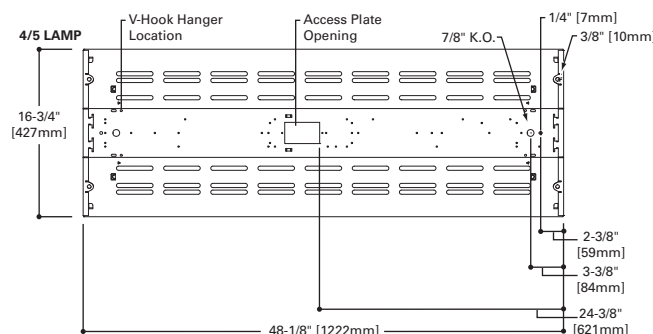

**ORDERING INFORMATION**

SAMPLE NUMBER: HBI-532-N-UNV-EB82/PLUS-MP-UPL-U Includes V Hangers for rapid installation<sup>(6)</sup>

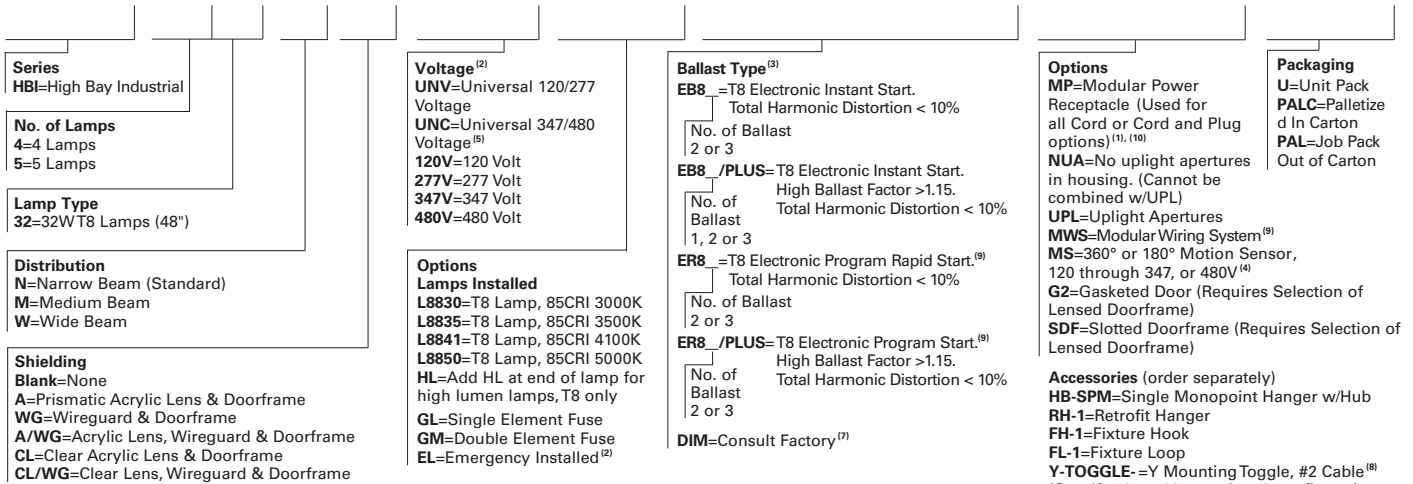

NOTES: <sup>(1)</sup>Requires use of MC\_ or MPC\_cord accessories, specify voltage for plugs. <sup>(2)</sup>Voltage must be specified when ordered with plugs or emergency ballasts. <sup>(3)</sup>ER8 and EB8 ballast systems suitable for operation in ambient environments up to 122°F (50°C) in open upright configuration. <sup>(4)</sup>When ordering MS option, specify UNV (for 120 or 277V), 347 or 480V. <sup>(5)</sup>2/3 lamp ballast configurations in EB8/PLUS only for T8 UNC versions. <sup>(6)</sup>Can be used in high abuse applications such as gymnasiums. <sup>(7)</sup>Dimming ballast must be specified at time of order. <sup>(8)</sup>Two required. <sup>(9)</sup>Cannot be combined with Modular Power Receptacle (MP). <sup>(10)</sup>For MWS with MP, choose MP in fixture logic and then choose MWS accessory such as MDS6.

**SHIPPING DATA**

Catalog No.	Wt.
HBI-432-UPL	16 lbs.
HBI-532-UPL	16 lbs.



**Quick Ship Ordering Information** Sample Number: HBI432-MP-UPL-L5

Quick Ship orders ship in 5 days in order quantities not to exceed 200 pieces. Includes V Hangers for rapid installation<sup>(6)</sup>

NOTE: Orders received after noon are entered on the following day.

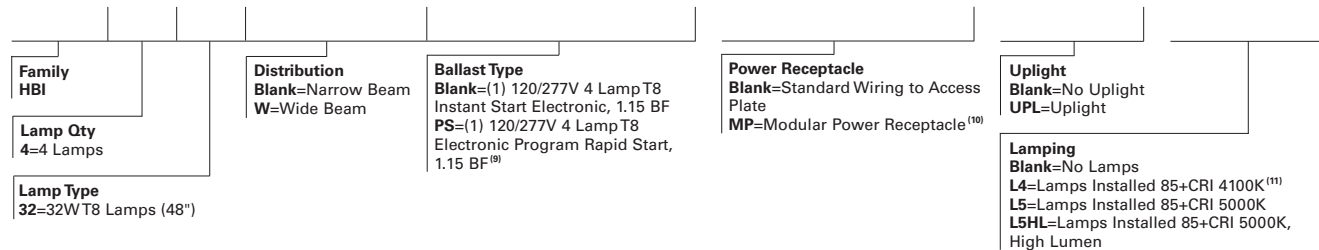

NOTES: <sup>(9)</sup>Recommended when utilizing Motion Sensor option. <sup>(10)</sup>Requires use of Modular cord and plug accessories. <sup>(11)</sup>High lumen (3100 initial) lamps supplied for 4100K.

PHOTOMETRICS

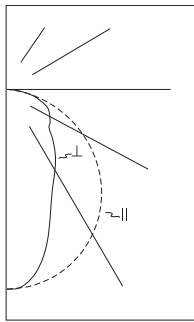

**HBI-432-N-UNV-EB81/PLUS**  
 Electronic Ballasts  
 (4) 32WT8 Lamps  
 3100 lumens  
 Spacing criterion:  
 (II) 1.3 x mounting  
 height, (L) 0.8 x  
 mounting height  
 Efficiency 90.5%  
 Test Report: HBI432  
 LER =FL-83  
 Yearly Cost of 1000  
 lumens, 3000 hrs at  
 .08 KWH = \$2.88

Candela			
Angle	Along II	45°	Across L
0	5703	5703	5703
5	5674	5641	5614
10	5603	5400	5189
15	5488	4970	4478
20	5318	4382	3659
25	5102	3691	3096
30	4842	3108	2736
35	4540	2680	2429
40	4192	2348	2096
45	3808	2037	1774
50	3391	1704	1583
55	2943	1390	1505
60	2465	1200	1408
65	1978	1083	1301
70	1478	963	1082
75	982	777	864
80	514	537	545
85	135	233	195
90	0	0	0

Coefficients of Utilization

rc rw RCR	Effective floor cavity reflectance																	
	80%				70%				20%									
	70	50	30	10	70	50	30	10	50	30	10	0						
0	108	108	108	108	105	105	105	105	101	101	101	96	96	96	92	92	92	90
1	99	94	91	87	96	92	89	86	88	86	83	85	83	80	82	80	78	76
2	90	83	77	72	88	81	76	71	78	73	69	75	71	68	72	69	66	64
3	83	73	66	60	80	72	65	60	69	64	59	67	62	58	64	60	57	55
4	76	65	58	52	74	64	57	52	62	56	51	60	55	50	58	53	50	48
5	70	59	51	45	68	58	51	45	56	50	45	54	49	44	53	48	44	42
6	65	54	46	40	64	53	45	40	51	45	40	50	44	39	48	43	39	37
7	61	49	41	36	59	48	41	36	47	40	36	46	40	35	44	39	35	33
8	57	45	38	32	55	44	37	32	43	37	32	42	36	32	41	36	32	30
9	53	42	34	30	52	41	34	29	40	34	29	39	33	29	38	33	29	27
10	50	39	32	27	49	38	31	27	37	31	27	36	31	27	36	30	27	25

Zonal Lumen Summary

Zone	Lumens	%Lamp	%Fixture
0-30	3731	30.1	33.3
0-40	5653	45.6	50.4
0-60	8940	72.1	79.7
0-90	11219	90.5	100.0
0-180	11219	90.5	100.0

Luminance Data

Angle in Deg	Average 0-Deg cd/sm	Average 45-Deg cd/sm	Average 90-Deg cd/sm
45	12681	6784	5908
55	12082	5707	6179
65	11021	6034	7249
75	8934	7069	7861
85	3647	6295	5269

Modular F-Bay Power Supply Option

Cooper Lighting's F-Bay Modular Power Supply option is available for use with all F-Bay products. The modular power supply allows external fixture access for safe and easy servicing. There is no need to remove lamps or reflectors to disconnect fixture power with F-Bay Modular Power Supply. Access to the individual fixture's power supply allows servicing without turning off all the fixtures, disrupting occupants. F-Bay Modular Power Supply is a time-saver in installation – **simply plug & power.**



1. Modular Power Supply Receptacle supplied mounted into fixture Access Plate
2. Modular Power Cord & Plugs in 120, 277, 347, & 480V configurations for easy plug & power into existing supply

No internal fixture access required for installation or disconnecting power

Modular Motion Sensor Option supplied with Mounting Box and Modular Power Supply Receptacle

Code Compliance

- UL/cUL Certified for Make/Break under load (UL2549)
- Meets NEC requirements for ballast disconnect (NEC 410.73G)
- Allows for addition of Occupancy Sensor without hard connections
- Receptacles complete with insulating/dust cap

PHOTOMETRICS

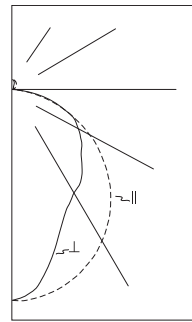

**HBI-532-N-UNV-EB82/PLUS-UPL**  
 Electronic Ballasts  
 (5) 32WT8 Lamps  
 3100 lumens  
 Spacing criterion:  
 (II) 1.3 x mounting  
 height, (L) 0.8 x  
 mounting height  
 Efficiency 90.4%  
 Test Report: HBI532-  
 UPL  
 LER =FL-85  
 Yearly Cost of 1000  
 lumens, 3000 hrs at  
 .08 KWH = \$2.81

Candela			
Angle	Along II	45°	Across L
0	5983	5983	5983
5	5976	5878	5795
10	5885	5603	5309
15	5748	5152	4681
20	5562	4597	4103
25	5322	4062	3697
30	5034	3613	3450
35	4703	3261	3317
40	4338	2981	3085
45	3938	2793	2781
50	3482	2497	2575
55	3011	2157	2366
60	2506	1922	2147
65	1976	1667	1931
70	1477	1421	1479
75	971	1063	1115
80	494	647	599
85	111	189	151
90	0	4	2

Coefficients of Utilization

rc rw RCR	Effective floor cavity reflectance																	
	80%				70%				20%									
	70	50	30	10	70	50	30	10	50	30	10	0						
0	107	107	107	107	104	104	104	104	99	99	99	94	94	94	90	90	90	88
1	98	93	90	86	95	91	88	84	87	84	81	83	81	78	79	77	76	74
2	89	81	75	70	86	79	74	69	76	71	67	73	69	65	69	66	63	61
3	81	72	64	58	79	70	63	58	67	61	56	64	59	55	61	57	54	52
4	74	63	56	50	72	62	55	49	60	53	48	57	52	47	55	50	46	44
5	68	57	49	43	66	56	48	42	54	47	42	51	46	41	50	45	40	38
6	63	51	43	38	61	50	43	37	48	42	37	47	41	36	45	40	36	34
7	59	47	39	33	57	46	38	33	44	38	33	43	37	32	41	36	32	30
8	55	43	35	30	53	42	35	30	41	34	29	39	33	29	38	33	29	27
9	51	39	32	27	50	39	32	27	37	31	27	36	31	26	35	30	26	24
10	48	36	29	25	47	36	29	24	35	29	24	34	28	24	33	28	24	22

Zonal Lumen Summary

Zone	Lumens	%Lamp	%Fixture
0-30	3999	25.8	28.5
0-40	6258	40.4	44.6
0-60	10620	68.5	75.8
0-90	13640	88.0	97.3
0-180	14017	90.4	100.0

Luminance Data

Angle in Deg	Average 0-Deg cd/sm	Average 45-Deg cd/sm	Average 90-Deg cd/sm
45	11540	8185	8149
55	10877	7792	8547
65	9688	8173	9468
75	7774	8510	8927
85	2639	4493	3590

# COOPER LIGHTING - METALUX®

## DESCRIPTION

The HBI series is an outstanding solution for high mounting height industrial or retail applications. The HBI optic has been optimized to provide maximum performance from T8 lamps. Optional uplight component is provided to enable excellent ceiling uniformity. HBI's high lumen package allows the benefits of fluorescent to be applied at high mounting heights that were traditionally exclusive to H.I.D. The primary benefits include exceptional color rendering, high system efficacy, 95% lumen maintenance, long lamp life, instant on/instant re-strike, economical dimming, and uniform brightness control. Primary applications include retail, shopping malls, light industrial, gymnasiums and recreational environments.

## SPECIFICATION FEATURES

### Construction

Full bodied steel housing with integral ballast channel adds strength, rigidity and structural protection for optical assembly.

### Electrical

The HBI comes with a standard Class P electronic ballast and twistlock lampholders. UL/cUL listed for high ambient environments up to 55°C (131°F) for all lamps and ballast combinations when used in open upright configurations. Suitable for damp locations. Optional modular power receptacle meets UL2459 and NEC 410.73 and is UL/cUL rated for make and break under load from outside the luminaire to speed maintenance.

### Finish

White enamel finish preceded by a multistage cleaning cycle, iron phosphate coating with rust inhibitor to protect against contaminants and oxidation.

### Downlight/Uplight Optics

Die formed, segmented optical design optimizes performance across three distributions. Optical choices include a narrow distribution for aisles, medium distribution for assembly and loading areas, or wide distribution for general, open area lighting. An uplight option is offered to permit ceiling uniformity and allow for ample lamp and luminaire heat dissipation. Gasketed door frame & lens assembly is optional for more demanding environments.

Catalog #		Type
Project		
Comments		Date
Prepared by		

### Options

Integral Occupancy Sensor available and provides from 600 sq. ft. (MS) up to 1250 sq. ft. (MSO) of coverage at a maximum mounting height of 40' using interchangeable lens caps provided.

### Mounting

The HBI series is suited for suspension mounting with optional wire hook and chain set or cable mounting. Single monopoint mounting is available with SPM Tong Hanger.

### Warranty

When operated in high ambient conditions, the HBI is supported by a 5 yr/55°C and 3 yr/65°C ballast warranty when used with a high power factor ballast in open, upright configurations. To maximize your warranty, the HBI should be ordered with a high power factor ballast in ambient environments that typically exceed 40°C (102°F).



## HBI SERIES

4 OR 5 T8 LAMPS

High-Bay Industrial Fluorescent Luminaire



## ENERGY DATA

Input Watts:

**EB Ballast**

432 (109), 532 (133)

**EB/Plus Ballast**

432 (145), 532 (182)

Luminaire Efficacy Rating

**LER = FL-83 (Narrow Beam)**

Catalog Number: HBI-432-N

Yearly Cost of 1000 lumens,  
3000 hrs at .08 KWH = \$2.88

\*Reference the lamp/ballast data in the Technical Section for specific lamp/ballast requirements.

\*\*Consult Pre Sales Technical Support.

**LAMPS CONTAIN MERCURY. DISPOSE ACCORDING TO LOCAL, STATE OR FEDERAL LAWS**

**LINEAR DISCONNECT**

Safe and convenient means of disconnecting power.

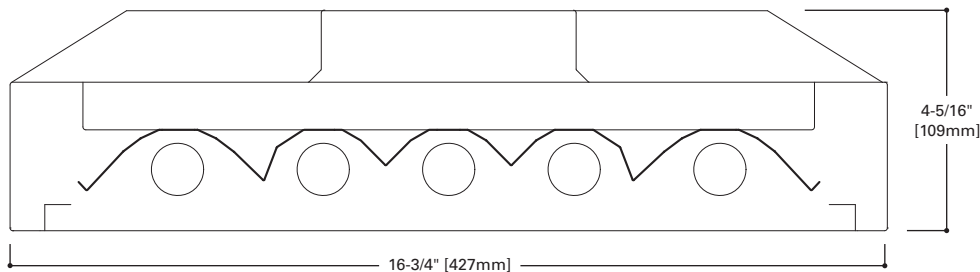

## LAMP CONFIGURATIONS

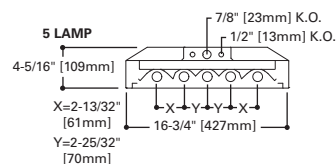
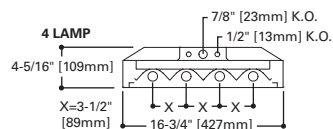

## DIMENSION TOP VIEW

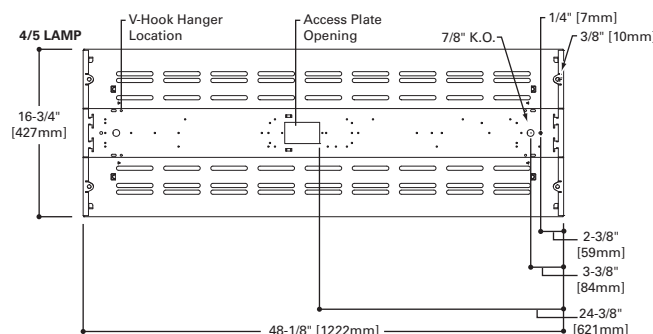

**ORDERING INFORMATION**

SAMPLE NUMBER: HBI-532-N-UNV-EB82/PLUS-MP-UPL-U Includes V Hangers for rapid installation<sup>(6)</sup>

<p><b>Series</b> HBI=High Bay Industrial</p>	<p><b>Voltage</b><sup>(2)</sup> UNV=Universal 120/277 Voltage UNC=Universal 347/480 Voltage<sup>(6)</sup> 120V=120 Volt 277V=277 Volt 347V=347 Volt 480V=480 Volt</p>	<p><b>Ballast Type</b><sup>(3)</sup> EB8 =T8 Electronic Instant Start. Total Harmonic Distortion &lt; 10% No. of Ballast 2 or 3 EB8 /PLUS= T8 Electronic Instant Start. High Ballast Factor &gt;1.15. Total Harmonic Distortion &lt; 10% No. of Ballast 1, 2 or 3 ER8 =T8 Electronic Program Rapid Start.<sup>(9)</sup> Total Harmonic Distortion &lt; 10% No. of Ballast 2 or 3 ER8 /PLUS= T8 Electronic Program Start.<sup>(9)</sup> High Ballast Factor &gt;1.15. Total Harmonic Distortion &lt; 10% No. of Ballast 2 or 3 DIM=Consult Factory<sup>(7)</sup></p>	<p><b>Options</b> MP=Modular Power Receptacle (Used for all Cord or Cord and Plug options)<sup>(11),(10)</sup> NUA=No upright apertures in housing. (Cannot be combined w/UPL) UPL=Uplight Apertures MWS=Modular Wiring System<sup>(9)</sup> MS=360° or 180° Motion Sensor, 120 through 347, or 480V<sup>(4)</sup> G2=Gasketed Door (Requires Selection of Lensed Doorframe) SDF=Slotted Doorframe (Requires Selection of Lensed Doorframe)</p>	<p><b>Packaging</b> U=Unit Pack PALC=Palletized In Carton PAL=Job Pack Out of Carton</p>
<p><b>No. of Lamps</b> 4=4 Lamps 5=5 Lamps</p>	<p><b>Options</b> <b>Lamps Installed</b> L8830=T8 Lamp, 85CRI 3000K L8835=T8 Lamp, 85CRI 3500K L8841=T8 Lamp, 85CRI 4100K L8850=T8 Lamp, 85CRI 5000K HL=Add HL at end of lamp for high lumen lamps, T8 only GL=Single Element Fuse GM=Double Element Fuse EL=Emergency Installed<sup>(2)</sup></p>	<p><b>Accessories</b> (order separately) HB-SPM=Single Monopoint Hanger w/Hub RH-1=Retrofit Hanger FH-1=Fixture Hook FL-1=Fixture Loop Y-TOGGLE= Y Mounting Toggle, #2 Cable<sup>(8)</sup> (Specify 10' or 30', requires 2 per fixture) HBAYC-CHAIN/SET/U=(2) V-Hook Hangers, 36" Chain Sets w/S-Hooks MC3=3' Modular Power Cord MPC3=3' Modular Power Cord &amp; Plug (Specify Voltage) MC6=6' Modular Power Cord MPC6=6' Modular Power Cord &amp; Plug (Specify Voltage) MMS=360° or 180° Aisle Motion Sensor with Modular Power Receptacle (120-277V)<sup>(1)</sup> MDS6=6' Modular Power Cord with MWS 27DS18/2G06MP Connector<sup>(10)</sup> SWG=Heavy Duty Wireguard for Field Installation</p>		
<p><b>Lamp Type</b> 32=32WT8 Lamps (48")</p>	<p><b>Distribution</b> N=Narrow Beam (Standard) M=Medium Beam W=Wide Beam</p>			
<p><b>Shielding</b> Blank=None A=Prismatic Acrylic Lens &amp; Doorframe WG=Wireguard &amp; Doorframe A/WG=Acrylic Lens, Wireguard &amp; Doorframe CL=Clear Acrylic Lens &amp; Doorframe CL/WG=Clear Lens, Wireguard &amp; Doorframe</p>				

NOTES: <sup>(1)</sup>Requires use of MC\_ or MPC\_cord accessories, specify voltage for plugs. <sup>(2)</sup>Voltage must be specified when ordered with plugs or emergency ballasts. <sup>(3)</sup>ER8 and EB8 ballast systems suitable for operation in ambient environments up to 122°F (50°C) in open upright configuration. <sup>(4)</sup>When ordering MS option, specify UNV (for 120 or 277V), 347 or 480V. <sup>(5)</sup>2/3 lamp ballast configurations in EB8/PLUS only for T8 UNC versions. <sup>(6)</sup>Can be used in high abuse applications such as gymnasiums. <sup>(7)</sup>Dimming ballast must be specified at time of order. <sup>(8)</sup>Two required. <sup>(9)</sup>Cannot be combined with Modular Power Receptacle (MP). <sup>(10)</sup>For MWS with MP, choose MP in fixture logic and then choose MWS accessory such as MDS6.

**SHIPPING DATA**

Catalog No.	Wt.
HBI-432-UPL	16 lbs.
HBI-532-UPL	16 lbs.



**Quick Ship Ordering Information** Sample Number: HBI432-MP-UPL-L5

Quick Ship orders ship in 5 days in order quantities not to exceed 200 pieces. Includes V Hangers for rapid installation<sup>(6)</sup>

NOTE: Orders received after noon are entered on the following day.

<p><b>Family</b> HBI</p>	<p><b>Distribution</b> Blank=Narrow Beam W=Wide Beam</p>	<p><b>Ballast Type</b> Blank=(1) 120/277V 4 Lamp T8 Instant Start Electronic, 1.15 BF PS=(1) 120/277V 4 Lamp T8 Electronic Program Rapid Start, 1.15 BF<sup>(9)</sup></p>	<p><b>Power Receptacle</b> Blank=Standard Wiring to Access Plate MP=Modular Power Receptacle<sup>(10)</sup></p>	<p><b>Uplight</b> Blank=No Uplight UPL=Uplight</p>
<p><b>Lamp Qty</b> 4=4 Lamps</p>				
<p><b>Lamp Type</b> 32=32WT8 Lamps (48")</p>				
<p><b>Lamping</b> Blank=No Lamps L4=Lamps Installed 85+CRI 4100K<sup>(11)</sup> L5=Lamps Installed 85+CRI 5000K L5HL=Lamps Installed 85+CRI 5000K, High Lumen</p>				

NOTES: <sup>(9)</sup>Recommended when utilizing Motion Sensor option. <sup>(10)</sup>Requires use of Modular cord and plug accessories. <sup>(11)</sup>High lumen (3100 initial) lamps supplied for 4100K.

PHOTOMETRICS

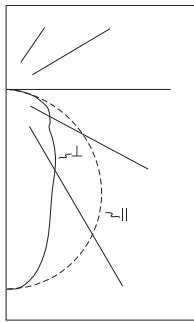

**HBI-432-N-UNV-EB81/PLUS**  
 Electronic Ballasts  
 (4) 32WT8 Lamps  
 3100 lumens  
 Spacing criterion:  
 (II) 1.3 x mounting  
 height, (L) 0.8 x  
 mounting height  
 Efficiency 90.5%  
 Test Report: HBI432  
 LER =FL-83  
 Yearly Cost of 1000  
 lumens, 3000 hrs at  
 .08 KWH = \$2.88

Candela			
Angle	Along II	45°	Across L
0	5703	5703	5703
5	5674	5641	5614
10	5603	5400	5189
15	5488	4970	4478
20	5318	4382	3659
25	5102	3691	3096
30	4842	3108	2736
35	4540	2680	2429
40	4192	2348	2096
45	3808	2037	1774
50	3391	1704	1583
55	2943	1390	1505
60	2465	1200	1408
65	1978	1083	1301
70	1478	963	1082
75	982	777	864
80	514	537	545
85	135	233	195
90	0	0	0

Coefficients of Utilization

rc rw RCR	Effective floor cavity reflectance																	
	80%				70%				20%									
	70	50	30	10	70	50	30	10	50	30	10	0						
0	108	108	108	108	105	105	105	105	101	101	101	96	96	96	92	92	92	90
1	99	94	91	87	96	92	89	86	88	86	83	85	83	80	82	80	78	76
2	90	83	77	72	88	81	76	71	78	73	69	75	71	68	72	69	66	64
3	83	73	66	60	80	72	65	60	69	64	59	67	62	58	64	60	57	55
4	76	65	58	52	74	64	57	52	62	56	51	60	55	50	58	53	50	48
5	70	59	51	45	68	58	51	45	56	50	45	54	49	44	53	48	44	42
6	65	54	46	40	64	53	45	40	51	45	40	50	44	39	48	43	39	37
7	61	49	41	36	59	48	41	36	47	40	36	46	40	35	44	39	35	33
8	57	45	38	32	55	44	37	32	43	37	32	42	36	32	41	36	32	30
9	53	42	34	30	52	41	34	29	40	34	29	39	33	29	38	33	29	27
10	50	39	32	27	49	38	31	27	37	31	27	36	31	27	36	30	27	25

Zonal Lumen Summary

Zone	Lumens	%Lamp	%Fixture
0-30	3731	30.1	33.3
0-40	5653	45.6	50.4
0-60	8940	72.1	79.7
0-90	11219	90.5	100.0
0-180	11219	90.5	100.0

Luminance Data

Angle in Deg	Average 0-Deg cd/sm	Average 45-Deg cd/sm	Average 90-Deg cd/sm
45	12681	6784	5908
55	12082	5707	6179
65	11021	6034	7249
75	8934	7069	7861
85	3647	6295	5269

PHOTOMETRICS

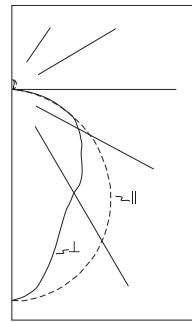

**HBI-532-N-UNV-EB82/PLUS-UPL**  
 Electronic Ballasts  
 (5) 32WT8 Lamps  
 3100 lumens  
 Spacing criterion:  
 (II) 1.3 x mounting  
 height, (L) 0.8 x  
 mounting height  
 Efficiency 90.4%  
 Test Report: HBI532-  
 UPL  
 LER =FL-85  
 Yearly Cost of 1000  
 lumens, 3000 hrs at  
 .08 KWH = \$2.81

Candela			
Angle	Along II	45°	Across L
0	5983	5983	5983
5	5976	5878	5795
10	5885	5603	5309
15	5748	5152	4681
20	5562	4597	4103
25	5322	4062	3697
30	5034	3613	3450
35	4703	3261	3317
40	4338	2981	3085
45	3938	2793	2781
50	3482	2497	2575
55	3011	2157	2366
60	2506	1922	2147
65	1976	1667	1931
70	1477	1421	1479
75	971	1063	1115
80	494	647	599
85	111	189	151
90	0	4	2

Coefficients of Utilization

rc rw RCR	Effective floor cavity reflectance																	
	80%				70%				20%									
	70	50	30	10	70	50	30	10	50	30	10	0						
0	107	107	107	107	104	104	104	104	99	99	99	94	94	94	90	90	90	88
1	98	93	90	86	95	91	88	84	87	84	81	83	81	78	79	77	76	74
2	89	81	75	70	86	79	74	69	76	71	67	73	69	65	69	66	63	61
3	81	72	64	58	79	70	63	58	67	61	56	64	59	55	61	57	54	52
4	74	63	56	50	72	62	55	49	60	53	48	57	52	47	55	50	46	44
5	68	57	49	43	66	56	48	42	54	47	42	51	46	41	50	45	40	38
6	63	51	43	38	61	50	43	37	48	42	37	47	41	36	45	40	36	34
7	59	47	39	33	57	46	38	33	44	38	33	43	37	32	41	36	32	30
8	55	43	35	30	53	42	35	30	41	34	29	39	33	29	38	33	29	27
9	51	39	32	27	50	39	32	27	37	31	27	36	31	26	35	30	26	24
10	48	36	29	25	47	36	29	24	35	29	24	34	28	24	33	28	24	22

Zonal Lumen Summary

Zone	Lumens	%Lamp	%Fixture
0-30	3999	25.8	28.5
0-40	6258	40.4	44.6
0-60	10620	68.5	75.8
0-90	13640	88.0	97.3
0-180	14017	90.4	100.0

Luminance Data

Angle in Deg	Average 0-Deg cd/sm	Average 45-Deg cd/sm	Average 90-Deg cd/sm
45	11540	8185	8149
55	10877	7792	8547
65	9688	8173	9468
75	7774	8510	8927
85	2639	4493	3590

Modular F-Bay Power Supply Option

Cooper Lighting's F-Bay Modular Power Supply option is available for use with all F-Bay products. The modular power supply allows external fixture access for safe and easy servicing. There is no need to remove lamps or reflectors to disconnect fixture power with F-Bay Modular Power Supply. Access to the individual fixture's power supply allows servicing without turning off all the fixtures, disrupting occupants. F-Bay Modular Power Supply is a time-saver in installation – **simply plug & power.**



1. Modular Power Supply Receptacle supplied mounted into fixture Access Plate
2. Modular Power Cord & Plugs in 120, 277, 347, & 480V configurations for easy plug & power into existing supply

No internal fixture access required for installation or disconnecting power

Modular Motion Sensor Option supplied with Mounting Box and Modular Power Supply Receptacle

Code Compliance

- UL/cUL Certified for Make/Break under load (UL2549)
- Meets NEC requirements for ballast disconnect (NEC 410.73G)
- Allows for addition of Occupancy Sensor without hard connections
- Receptacles complete with insulating/dust cap