

Watertight Devices
 20A, 3 Phase 480V AC, 3 Pole, 4 Wire
 Twist-Lock® Connector

HUBBELL

Features

- Smooth body design minimizes collection points simplifying the wash down process
- Strain relief nut always seals on the body, minimizing debris collection
- Stainless steel hardware and corrosion-resistant connection points

Ordering Information

Description	Cord Diameter	UPC	Catalog Number
Thermoplastic elastomer yellow connector	0.375"-0.875" (9.5-22.2)	783585131818	HBL27W76

Listings

Listed to UL498
 Certified to CSA C22.2 No. 42
 Meets NEMA WD-1, WD-6 and ANSI standards
 UL Listed, CSA Certified to Type 4, 4X, 12, 6, 6P

Specifications

Body	Thermoplastic Elastomer
Contact Carrier	White Nylon
Terminal Retainer	Clear polycarbonate
Contacts	Nickel plated brass
Core	White Nylon
Bushing & Cone Seal	Black Elastomer
Gotcha Ring	Nylon
Strain Relief Nut	PBT
Terminal Screws	Nickel Plated Brass

Performance

Electrical	
Current Interrupting	Rated for current interruption per UL498
Dielectric Voltage	3500V AC
Max Working Voltage	As marked
Temperature Rise	30°C max per UL498 at rated current
Mechanical	
Cord Accomodation	0.375"-0.875" (9.5-22.2)
Environmental	
Moisture Resistance	UL Listed 4, 4X, 12, 6, 6P
Operating temperatures	-40°C (without impact) to +60°C continuous
UV resistance	All exposed materials are UV stabilized

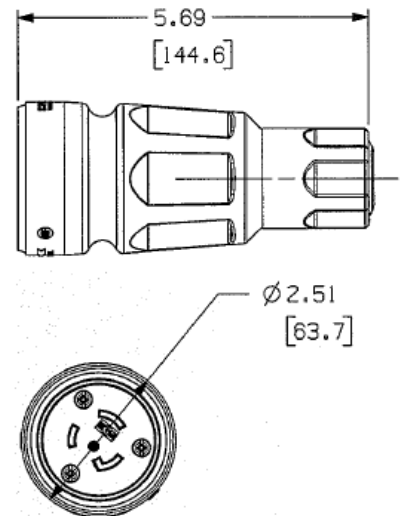

Complementary Products

Watertight Plug	HBL26W76
-----------------	----------

Online Resources

eCatalog

Dimensions in Inches (mm)

Hubbell Wiring Device-Kellems • Hubbell Incorporated (Delaware) • 40 Waterview Drive • Shelton, CT 06484

Phone (800) 288-6000 • Fax (800) 255-1031 • Specifications subject to change without notice.



Watertight Devices
 20A, 3 Phase 480V AC, 3 Pole, 4 Wire
 Twist-Lock® Connector

HUBBELL

Features

- Smooth body design minimizes collection points simplifying the wash down process
- Strain relief nut always seals on the body, minimizing debris collection
- Stainless steel hardware and corrosion-resistant connection points

Ordering Information

Description	Cord Diameter	UPC	Catalog Number
Thermoplastic elastomer yellow connector	0.375"-0.875" (9.5-22.2)	783585131818	HBL27W76

Listings

Listed to UL498
 Certified to CSA C22.2 No. 42
 Meets NEMA WD-1, WD-6 and ANSI standards
 UL Listed, CSA Certified to Type 4, 4X, 12, 6, 6P

Specifications

Body	Thermoplastic Elastomer
Contact Carrier	White Nylon
Terminal Retainer	Clear polycarbonate
Contacts	Nickel plated brass
Core	White Nylon
Bushing & Cone Seal	Black Elastomer
Gotcha Ring	Nylon
Strain Relief Nut	PBT
Terminal Screws	Nickel Plated Brass

Performance

Electrical	
Current Interrupting	Rated for current interruption per UL498
Dielectric Voltage	3500V AC
Max Working Voltage	As marked
Temperature Rise	30°C max per UL498 at rated current

Mechanical	
Cord Accomodation	0.375"-0.875" (9.5-22.2)

Environmental	
Moisture Resistance	UL Listed 4, 4X, 12, 6, 6P
Operating temperatures	-40°C (without impact) to +60°C continuous
UV resistance	All exposed materials are UV stabilized

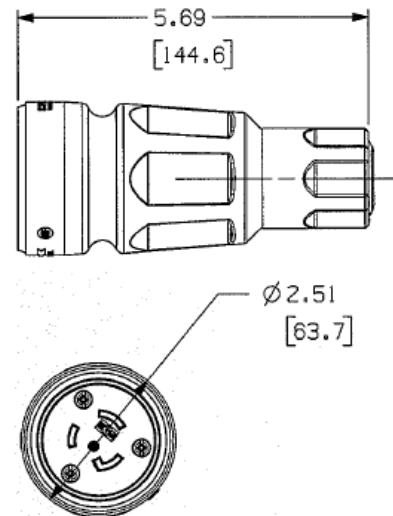

Complementary Products

Watertight Plug	HBL26W76
-----------------	----------

Online Resources

eCatalog

Dimensions in Inches (mm)

Hubbell Wiring Device-Kellems • Hubbell Incorporated (Delaware) • 40 Waterview Drive • Shelton, CT 06484

Phone (800) 288-6000 • Fax (800) 255-1031 • Specifications subject to change without notice.

