

**NICOR**<sup>®</sup> | **LED**

**LED** Linear Low/High Bay  
**HBL3**



Slimmer Profiles. Same Optimal Performance.





# Economical, Energy-Efficient Lighting Solutions for Most High Bay Applications



**The HBL3 LED Linear Low Bay/High Bay** improves on the HBL model by providing higher performance with a slim new design. It is the ideal lumen package for replacing metal halide and linear fluorescent high bay systems. The fixture supplies an output greater than 130 lumens per watt, meeting DLC premium. This energy-efficient and economical fixture offers high performance and long life, excellent color rendering, and even uniformity. The HBL3 is available in 4000K and 5000K color temperatures and has suggested mounting heights from 15ft and above, making it the perfect solution for warehouses, gymnasiums, garages and other storage areas, commercial and manufacturing facilities, as well as open and stack aisle applications.





# High Performance Design Can be Customized for Your Environment

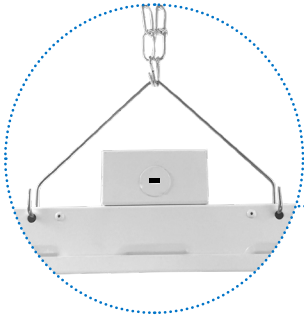

## Hassle-Free Mounting

Easy mounting with chain and hook or optional pendant kit

## Junction Box

Easy access to wiring makes installation hassle-free

## Surge Protection

Built-in 10kA surge protection standard  
20kA for High Voltage

## Rounded Edges

Smooth rounded edges provide safer handling of fixture



## High Efficacy LEDs

Provide long-lasting, efficient performance with uniform color and light distribution greater than 130 lumen/w

## Lens

Fixture comes standard with clear lens and has optional frosted diffuser available



# HBL3/HBL-20 Size Comparison



## HBL3 Product Measurements

Wattage:	HBL3110	HBL3162	HBL3223	HBL3321
Length:	23.8 in. (605mm)		23.8 in. (605mm)	46 in. (1166mm)
Width:	12.6 in. (320mm)		17.3 in. (440mm)	12.6 in. (320mm)
Height:	3.6 in. (92mm)		3.6 in. (92mm)	3.6 in. (92mm)



## HBL-20 Product Measurements

Wattage:	HBL-20-110W	HBL-20-162W	HBL-20-223W	HBL-20-321W
Length:	23.8 in. (605mm)	23.8 in. (605mm)	46 in. (1166mm)	46 in. (1166mm)
Width:	12.6 in. (320mm)	17.3 in. (440mm)	12.6 in. (320mm)	17.3 in. (440mm)
Height:	3.6 in. (92mm)	3.6 in. (92mm)	3.6 in. (92mm)	3.6 in. (92mm)



# Wattage Options

## HBL3110 Greater Than 14,000 Lumens\*

Dimensions: 23.8in (605mm) x 12.6in (320mm) x 3.6in (92mm)

- Rack & Aisle
- Storage areas
- Small Warehouses
- Garages



## HBL3162 Greater Than 21,000 Lumens\*

Dimensions: 23.8in (605mm) x 12.6in (320mm) x 3.6in (92mm)

- Manufacturing Facilities
- Gymnasiums
- Warehouses
- Garages



## HBL3223 Greater Than 29,000 Lumens\*

Dimensions: 23.8in (605mm) x 17.3in (440mm) x 3.6in (92mm)

- Showrooms
- Gymnasiums
- Warehouses
- Garages



## HBL3321 Greater Than 42,000 Lumens\*

Dimensions: 46in (1166mm) x 12.6in (320mm) x 3.6in (92mm)

- Manufacturing Facilities
- Airports
- Warehouses
- Sports complex



\*Based on 5000K

## HBL3 Module Comparison

	NICOR <sup>®</sup> LED HBL3 w/ Clear Lens at 5000K	HID	Fluorescent
Warehouses, manufacturing facilities, airports, sports complex 50-80' Ceilings	321W 43,026 LM	750W MH 859W	12 lamp T5 648W
Warehouses, gymnasiums, showrooms, garages 35-50' Ceilings	223W 29,234 LM	400W PSMH 458W	8 lamp T5 468W
Warehouses, manufacturing facilities, garages, gymnasiums 20-35' Ceilings	162W 21,356 LM	400W MH 458W	6 lamp T5 351W
Storage areas, garages, aisle lighting, small warehouses 15-25' Ceilings	110W 14,399 LM	250W MH 297W	4 lamp T5 234W



# HBL3

## Ordering Information

### Construction

- Durable steel construction with powder coat finish
- Vented steel housing provides thermal management through natural convection
- Top mounted wireway cover for easy wire access
- Offers four power level categories 110W, 162W, 223W, 321W
- Rated for use in damp locations

### Optical System

- Clear acrylic lens protects LEDs and provides optimal lumen output
- Frosted diffused acrylic lens also available

### Electrical

- Long-life LED system coupled with electrical driver to deliver optimal performance with over 130 lumens per watt with clear lens
- Utilizes advanced mid-powered LED technology with CCT of 4000K and 5000K with >80 CRI
- Operating temperature rating of -40°F to 122°F (-40°C to 45°C)
- 10kA surge protection standard
- Input voltage of 120-277V
- 347-480V input option available with 20kA surge protector
- Dimming: 0-10V standard
- THD less than 20%

### Mounting and Installation

- V-hook and chain (41.3 in, 1050 mm) mounting system included
- Optional pendant mount kit available
- Motion Sensor options available
- Six foot cord or FMC option available
- Wireguard option available for increased fixture protection
- For installations where power surge may be possible, NICOR recommends installing additional surge protection at the fixture or electrical distribution panel

### Warranty

- 5-year limited system warranty standard
- Warranty does not cover product failure due to an overvoltage event (power surge)
- TM-21 Projected L70 (9K) life > 122,000 hours
- LM-79, LM-80 testing performed in accordance with IESNA standards



### Performance Data

Model Number	Lumens	Watts	Lumen/Watt
HBL3110UNV40K	14389	109.0	132.1
HBL3110UNV50K	14399	107.9	133.4
HBL3162UNV40K	21132	158.5	133.3
HBL3162UNV50K	21356	159.6	133.8
HBL3223UNV40K	28615	216.4	132.2
HBL3223UNV50K	29234	217.7	134.3
HBL3321UNV40K	42115	318.9	132.1
HBL3321UNV50K	43026	318.7	135.0

### Performance Data with Diffused Lens

Model Number	Lumens	Watts	Lumen/Watt
HBL3110UNV40K	13734	107.8	127.4
HBL3110UNV50K	13824	107.7	128.4
HBL3162UNV40K	20215	158.7	127.4
HBL3162UNV50K	20497	159.3	128.7
HBL3223UNV40K	27764	216.2	128.4
HBL3223UNV50K	28047	216.9	129.3
HBL3321UNV40K	40390	319.0	126.6
HBL3321UNV50K	41244	318.7	129.4

### Ordering Information

Example: HBL3162UNV40K

Series	Version	Wattage	Voltage	CCT	Lens	Emergency	Wiring Options <sup>1</sup>
HBL	3	110 (110 Watts)	UNV (120-277V)	40K (4000K)	(Blank) Clear	(Blank) No Emergency Backup	(Blank) No Cord
		162 (162 Watts)	HV (347-480V)	50K (5000K)	D (Diffused)	E3 (EMB250 Battery)	C <sup>1</sup> (Cord)
		223 (223 Watts)					F (Flexible Metal Conduit)
		321 (321 Watts)					

<sup>1</sup> Plug options are field install only & requires wiring option



# Accessories



## Microwave Motion Sensor

Offering stand-by dimming during vacancy at 50, 30, 20 and 10 percent light output, this sensor facilitates greater energy savings. Remote control functionality.



## Infrared Motion Sensor

Multiple options to provide automatic control and energy savings.



## Cord & Plug Option

Standard 6ft cord with custom lengths available for wiring fixture.

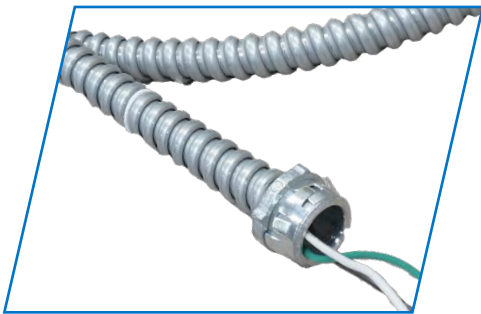

## Flexible Metal Conduit Option

Flexible metal conduit provides more wire protection and a secure fit.

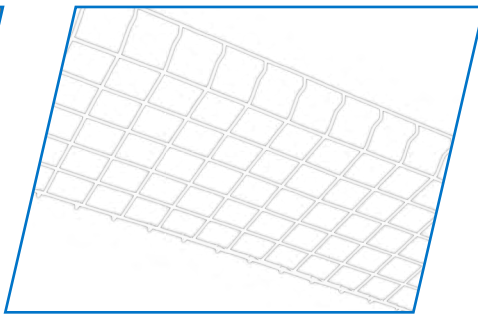

## Wire Guard Option

Wire guard options for HBL3 add protection to the lens from any potential damage.

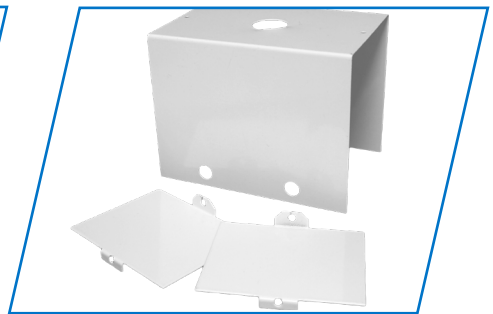

## Pendant Mount Option

The pendant mount option is available for all HBL fixtures.

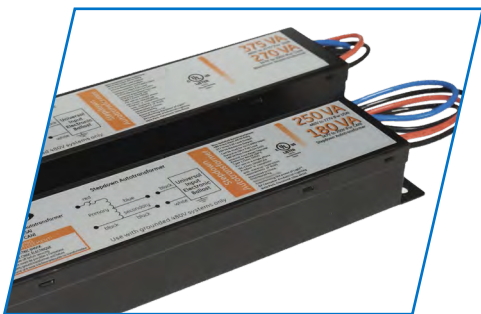

## High Voltage Transformers

High voltage transformers allow the fixture to receive a higher power input of 347V - 480V.



## Frosted Lens Option

The frosted lens option provides an even light spread and is ideal for lower ceiling applications



## Emergency Battery Back-up

The emergency battery back-up provides 90 minutes of power to your fixture in the event of power failure.

### Wireguard Accessories

Wireguard for 110W & 162W HBL3	HBL3110162-WG
Wireguard for 223W HBL3	HBL3223-WG
Wireguard for 321W HBL3	HBL3321-WG

### Lens Accessories

Diffuser for 110W & 162W HBL3	HBL3110162-FROS-DIFU
Diffuser for 223W HBL3	HBL3223-FROS-DIFU
Diffuser for 321W HBL3	HBL3321-FROS-DIFU

### Pendant Kit

Pendant Kit for 110W, 162W, 321W HBL3	HBL3110162321-P
Pendant Kit for 223W HBL3 & High Voltage 162W, 223W & 321W HBL3	HBL3223-P

### Emergency

Emergency Back-up	EMB250-10-UNV
-------------------	---------------

### Motion Sensors

Infrared Motion Sensor	HBOS360WH
Microwave Motion Sensor (No Remote Control)	MWOS360
Microwave Motion Sensor	MWOS360R
Remote Control for MWOS360R	MWOS-REMOTE

### Plug Accessories

15 amp 120V Straight Blade Plug	515P
15 amp 120V Twist Lock Plug	L515P
15 amp 250V Twist Lock Plug	L615P
15 amp 277V Twist Lock Plug	L715P
20 amp 277V Twist Lock Plug	L720P
20 amp 347V Twist Lock Plug	L2320P
20 amp 480V Twist Lock Plug	L820P

*1 Plug options are field install only & requires wiring option*



**NICOR**<sup>®</sup> | **LED**

**LED** Linear Low/High Bay  
**HBL3**



Slimmer Profiles. Same Optimal Performance.





# Economical, Energy-Efficient Lighting Solutions for Most High Bay Applications



**The HBL3 LED Linear Low Bay/High Bay** improves on the HBL model by providing higher performance with a slim new design. It is the ideal lumen package for replacing metal halide and linear fluorescent high bay systems. The fixture supplies an output greater than 130 lumens per watt, meeting DLC premium. This energy-efficient and economical fixture offers high performance and long life, excellent color rendering, and even uniformity. The HBL3 is available in 4000K and 5000K color temperatures and has suggested mounting heights from 15ft and above, making it the perfect solution for warehouses, gymnasiums, garages and other storage areas, commercial and manufacturing facilities, as well as open and stack aisle applications.





# High Performance Design Can be Customized for Your Environment

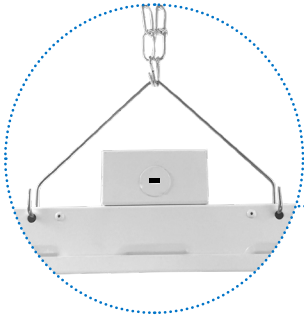

## Hassle-Free Mounting

Easy mounting with chain and hook or optional pendant kit

## Junction Box

Easy access to wiring makes installation hassle-free

## Surge Protection

Built-in 10kA surge protection standard  
20kA for High Voltage

## Rounded Edges

Smooth rounded edges provide safer handling of fixture



## High Efficacy LEDs

Provide long-lasting, efficient performance with uniform color and light distribution greater than 130 lumen/w

## Lens

Fixture comes standard with clear lens and has optional frosted diffuser available





# HBL3/HBL-20 Size Comparison

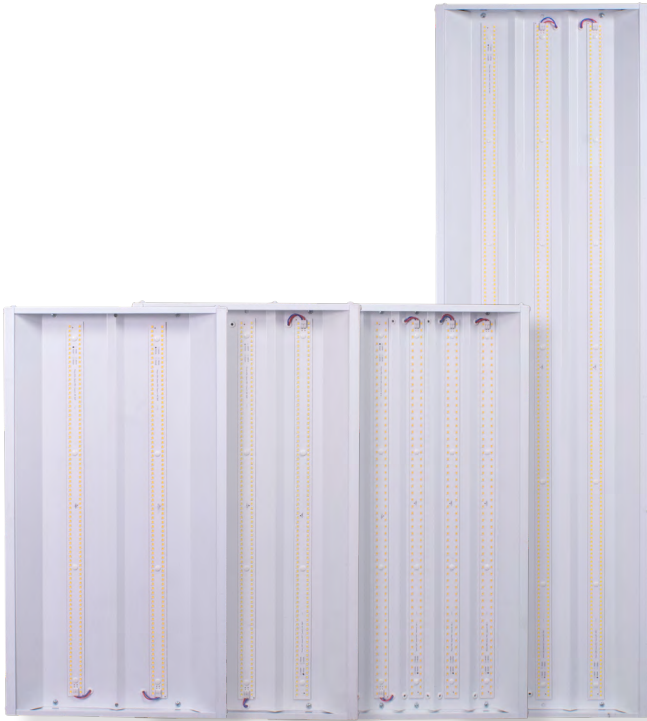

## HBL3 Product Measurements

Wattage:	HBL3110	HBL3162	HBL3223	HBL3321
Length:	23.8 in. (605mm)		23.8 in. (605mm)	46 in. (1166mm)
Width:	12.6 in. (320mm)		17.3 in. (440mm)	12.6 in. (320mm)
Height:	3.6 in. (92mm)		3.6 in. (92mm)	3.6 in. (92mm)



## HBL-20 Product Measurements

Wattage:	HBL-20-110W	HBL-20-162W	HBL-20-223W	HBL-20-321W
Length:	23.8 in. (605mm)	23.8 in. (605mm)	46 in. (1166mm)	46 in. (1166mm)
Width:	12.6 in. (320mm)	17.3 in. (440mm)	12.6 in. (320mm)	17.3 in. (440mm)
Height:	3.6 in. (92mm)	3.6 in. (92mm)	3.6 in. (92mm)	3.6 in. (92mm)



# Wattage Options

## HBL3110 Greater Than 14,000 Lumens\*

Dimensions: 23.8in (605mm) x 12.6in (320mm) x 3.6in (92mm)

- Rack & Aisle
- Storage areas
- Small Warehouses
- Garages



## HBL3162 Greater Than 21,000 Lumens\*

Dimensions: 23.8in (605mm) x 12.6in (320mm) x 3.6in (92mm)

- Manufacturing Facilities
- Gymnasiums
- Warehouses
- Garages



## HBL3223 Greater Than 29,000 Lumens\*

Dimensions: 23.8in (605mm) x 17.3in (440mm) x 3.6in (92mm)

- Showrooms
- Gymnasiums
- Warehouses
- Garages



## HBL3321 Greater Than 42,000 Lumens\*

Dimensions: 46in (1166mm) x 12.6in (320mm) x 3.6in (92mm)

- Manufacturing Facilities
- Airports
- Warehouses
- Sports complex



\*Based on 5000K

## HBL3 Module Comparison

	NICOR <sup>®</sup> LED HBL3 w/ Clear Lens at 5000K	HID	Fluorescent
Warehouses, manufacturing facilities, airports, sports complex 50-80' Ceilings	321W 43,026 LM	750W MH 859W	12 lamp T5 648W
Warehouses, gymnasiums, showrooms, garages 35-50' Ceilings	223W 29,234 LM	400W PSMH 458W	8 lamp T5 468W
Warehouses, manufacturing facilities, garages, gymnasiums 20-35' Ceilings	162W 21,356 LM	400W MH 458W	6 lamp T5 351W
Storage areas, garages, aisle lighting, small warehouses 15-25' Ceilings	110W 14,399 LM	250W MH 297W	4 lamp T5 234W



# HBL3

## Ordering Information

### Construction

- Durable steel construction with powder coat finish
- Vented steel housing provides thermal management through natural convection
- Top mounted wireway cover for easy wire access
- Offers four power level categories 110W, 162W, 223W, 321W
- Rated for use in damp locations

### Optical System

- Clear acrylic lens protects LEDs and provides optimal lumen output
- Frosted diffused acrylic lens also available

### Electrical

- Long-life LED system coupled with electrical driver to deliver optimal performance with over 130 lumens per watt with clear lens
- Utilizes advanced mid-powered LED technology with CCT of 4000K and 5000K with >80 CRI
- Operating temperature rating of -40°F to 122°F (-40°C to 45°C)
- 10kA surge protection standard
- Input voltage of 120-277V
- 347-480V input option available with 20kA surge protector
- Dimming: 0-10V standard
- THD less than 20%

### Mounting and Installation

- V-hook and chain (41.3 in, 1050 mm) mounting system included
- Optional pendant mount kit available
- Motion Sensor options available
- Six foot cord or FMC option available
- Wireguard option available for increased fixture protection
- For installations where power surge may be possible, NICOR recommends installing additional surge protection at the fixture or electrical distribution panel

### Warranty

- 5-year limited system warranty standard
- Warranty does not cover product failure due to an overvoltage event (power surge)
- TM-21 Projected L70 (9K) life > 122,000 hours
- LM-79, LM-80 testing performed in accordance with IESNA standards



### Performance Data

Model Number	Lumens	Watts	Lumen/Watt
HBL3110UNV40K	14389	109.0	132.1
HBL3110UNV50K	14399	107.9	133.4
HBL3162UNV40K	21132	158.5	133.3
HBL3162UNV50K	21356	159.6	133.8
HBL3223UNV40K	28615	216.4	132.2
HBL3223UNV50K	29234	217.7	134.3
HBL3321UNV40K	42115	318.9	132.1
HBL3321UNV50K	43026	318.7	135.0

### Performance Data with Diffused Lens

Model Number	Lumens	Watts	Lumen/Watt
HBL3110UNV40K	13734	107.8	127.4
HBL3110UNV50K	13824	107.7	128.4
HBL3162UNV40K	20215	158.7	127.4
HBL3162UNV50K	20497	159.3	128.7
HBL3223UNV40K	27764	216.2	128.4
HBL3223UNV50K	28047	216.9	129.3
HBL3321UNV40K	40390	319.0	126.6
HBL3321UNV50K	41244	318.7	129.4

### Ordering Information

Example: HBL3162UNV40K

Series	Version	Wattage	Voltage	CCT	Lens	Emergency	Wiring Options <sup>1</sup>
HBL	3	110 (110 Watts)	UNV (120-277V)	40K (4000K)	(Blank) Clear	(Blank) No Emergency Backup	(Blank) No Cord
		162 (162 Watts)	HV (347-480V)	50K (5000K)	D (Diffused)	E3 (EMB250 Battery)	C <sup>1</sup> (Cord)
		223 (223 Watts)					F (Flexible Metal Conduit)
		321 (321 Watts)					

<sup>1</sup> Plug options are field install only & requires wiring option



# Accessories



## Microwave Motion Sensor

Offering stand-by dimming during vacancy at 50, 30, 20 and 10 percent light output, this sensor facilitates greater energy savings. Remote control functionality.



## Infrared Motion Sensor

Multiple options to provide automatic control and energy savings.



## Cord & Plug Option

Standard 6ft cord with custom lengths available for wiring fixture.

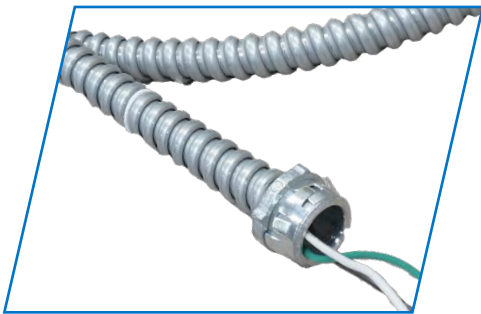

## Flexible Metal Conduit Option

Flexible metal conduit provides more wire protection and a secure fit.

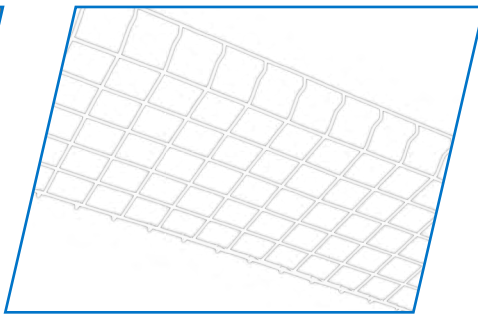

## Wire Guard Option

Wire guard options for HBL3 add protection to the lens from any potential damage.

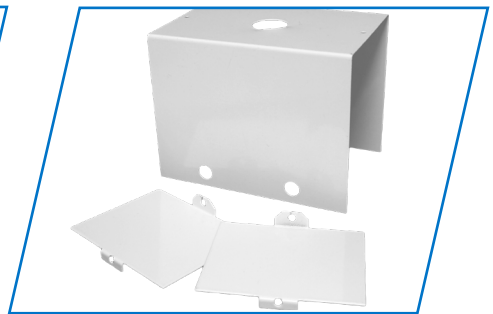

## Pendant Mount Option

The pendant mount option is available for all HBL fixtures.

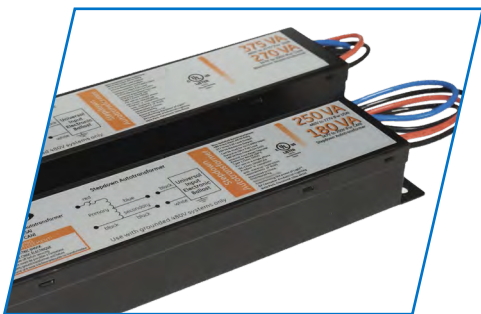

## High Voltage Transformers

High voltage transformers allow the fixture to receive a higher power input of 347V - 480V.



## Frosted Lens Option

The frosted lens option provides an even light spread and is ideal for lower ceiling applications



## Emergency Battery Back-up

The emergency battery back-up provides 90 minutes of power to your fixture in the event of power failure.

Wireguard Accessories	
Wireguard for 110W & 162W HBL3	HBL3110162-WG
Wireguard for 223W HBL3	HBL3223-WG
Wireguard for 321W HBL3	HBL3321-WG
Lens Accessories	
Diffuser for 110W & 162W HBL3	HBL3110162-FROS-DIFU
Diffuser for 223W HBL3	HBL3223-FROS-DIFU
Diffuser for 321W HBL3	HBL3321-FROS-DIFU
Pendant Kit	
Pendant Kit for 110W, 162W, 321W HBL3	HBL3110162321-P
Pendant Kit for 223W HBL3 & High Voltage 162W, 223W & 321W HBL3	HBL3223-P

Emergency	
Emergency Back-up	EMB250-10-UNV
Motion Sensors	
Infrared Motion Sensor	HBOS360WH
Microwave Motion Sensor (No Remote Control)	MWOS360
Microwave Motion Sensor	MWOS360R
Remote Control for MWOS360R	MWOS-REMOTE

Plug Accessories	
15 amp 120V Straight Blade Plug	515P
15 amp 120V Twist Lock Plug	L515P
15 amp 250V Twist Lock Plug	L615P
15 amp 277V Twist Lock Plug	L715P
20 amp 277V Twist Lock Plug	L720P
20 amp 347V Twist Lock Plug	L2320P
20 amp 480V Twist Lock Plug	L820P

*1 Plug options are field install only & requires wiring option*