



HPS-1000A-P-KIT

1000W HIGH PRESSURE SODIUM BALLAST KIT



LAMP TYPE: 1000W High Pressure Sodium (S52) **INPUT VOLTAGE:** 5-Tap (120/208/240/277/480) **CIRCUIT TYPE:** CWA

PRODUCT FEATURES

- ANSI Designation: S52
- Line Voltage: 120/208/240/277/480
- Regulation: 10%
- Frequency: 60 Hz
- Recommended Fuse (A): 20/15/10/10/8
- Circuit Type: CWA
- Insulation Class: 180°C
- Capacitor: 26 μ F
- Capacitor Voltage Rating: 525 V
- Winding Materials: Cu/Al
- Lamp Starter: IGN-XG-03 /P
- Agency Certification: RU, cRU

ELECTRICAL SPECIFICATIONS

LINE VOLTAGE	POWER FACTOR	LINE CURRENT			INPUT POWER	OPEN CIRCUIT VOLTAGE	MINIMUM START TEMP	UL TEMP CODE
		OPERATING	OPEN CIRCUIT	STARTING				
120V	High	9.57A	2.29A	32A	1150	432	-40°C	E
208V	High	5.45A	1.28A	28A	1150	429	-40°C	D
240V	High	4.73A	1.13A	20A	1150	430	-40°C	E
277V	High	4.07A	0.96A	18A	1150	428	-40°C	E
480V	High	2.37A	0.57A	9.6A	1150	430	-40°C	D

WIRING DIAGRAM

DIAGRAM H9

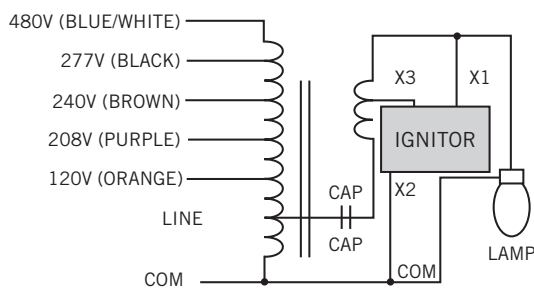

Input wires may be color coded as shown above or all white and labeled accordingly.

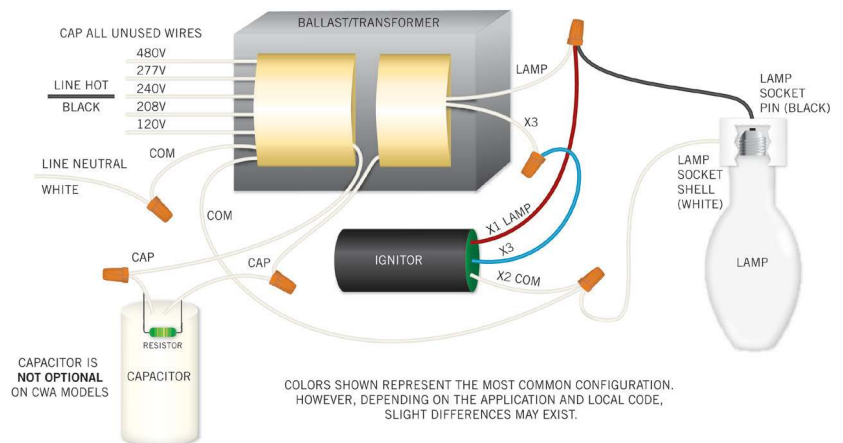



HPS-1000A-P-KIT

1000W HIGH PRESSURE SODIUM BALLAST KIT

PHYSICAL SPECIFICATIONS

BALLAST SPECIFICATIONS

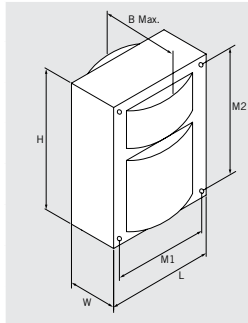

LENGTH	4.30"
WIDTH	5.30"
HEIGHT	6.03"
MOUNTING 1	3.90"
MOUNTING 2	5.37"
B MAX.	8.35"
NET WEIGHT	33 lbs
LEAD LENGTH	12"

CAPACITOR SPECIFICATIONS

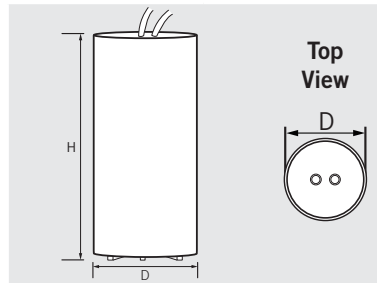

DIAMETER	1.88"
HEIGHT	3.89"
TYPE	Dry Film

IGNITOR SPECIFICATIONS

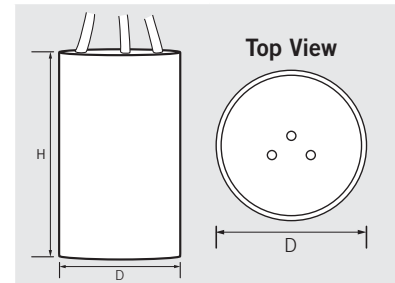

DIAMETER	1.32"
HEIGHT	2.34"
TYPE	CWA

ORDERING INFORMATION

ORDER CODE	PACKAGING STYLE	PACK QTY.	ITEM STATUS
HPS-1000A-P-KIT 3/1	Individually Packaged	1	Quick Ship

Each kit includes the ballast pre-wired to a properly rated capacitor and ignitor (if required), mounting hardware, and pictorial installation guide.

CATALOG NUMBER BREAKDOWN

HPS-1000A-P-KIT

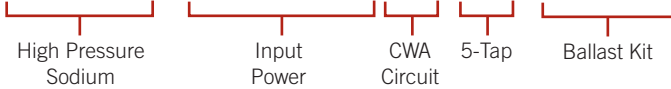

HPS-1000A-P-KIT

1000W HIGH PRESSURE SODIUM BALLAST KIT



LAMP TYPE: 1000W High Pressure Sodium (S52)	INPUT VOLTAGE: 5-Tap (120/208/240/277/480)	CIRCUIT TYPE: CWA
--	---	--------------------------

PRODUCT FEATURES

- | | | |
|--|--|---|
| <ul style="list-style-type: none"> • ANSI Designation: S52 • Line Voltage: 120/208/240/277/480 • Regulation: 10% • Frequency: 60 Hz • Recommended Fuse (A): 20/15/10/10/8 | <ul style="list-style-type: none"> • Circuit Type: CWA • Insulation Class: 180°C • Capacitor: 26 μF • Capacitor Voltage Rating: 525 V | <ul style="list-style-type: none"> • Winding Materials: Cu/Al • Lamp Starter: IGN-XG-03 /P • Agency Certification: RU, cRU |
|--|--|---|

ELECTRICAL SPECIFICATIONS

LINE VOLTAGE	POWER FACTOR	LINE CURRENT			INPUT POWER	OPEN CIRCUIT VOLTAGE	MINIMUM START TEMP	UL TEMP CODE
		OPERATING	OPEN CIRCUIT	STARTING				
120V	High	9.57A	2.29A	32A	1150	432	-40°C	E
208V	High	5.45A	1.28A	28A	1150	429	-40°C	D
240V	High	4.73A	1.13A	20A	1150	430	-40°C	E
277V	High	4.07A	0.96A	18A	1150	428	-40°C	E
480V	High	2.37A	0.57A	9.6A	1150	430	-40°C	D

WIRING DIAGRAM

DIAGRAM H9

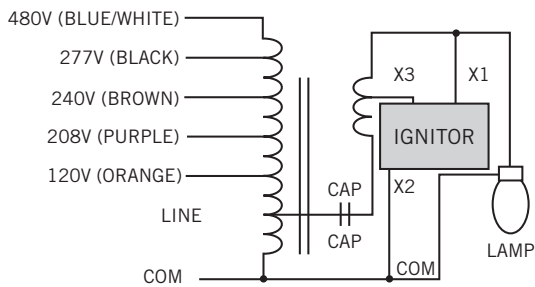

Input wires may be color coded as shown above or all white and labeled accordingly.

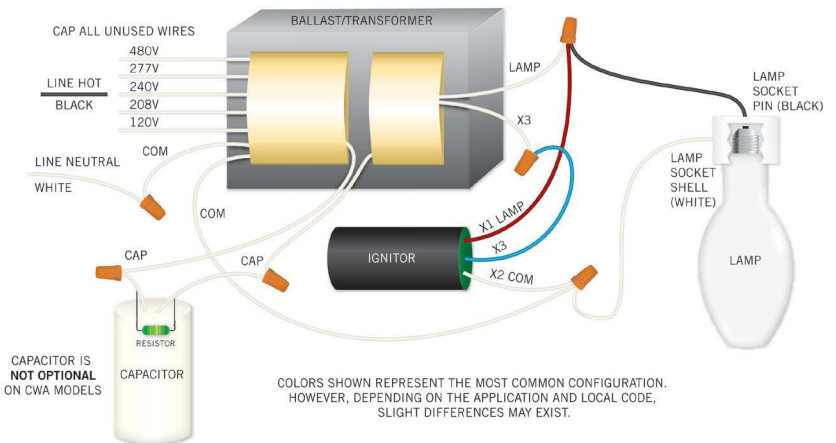



HPS-1000A-P-KIT

1000W HIGH PRESSURE SODIUM BALLAST KIT

PHYSICAL SPECIFICATIONS

BALLAST SPECIFICATIONS

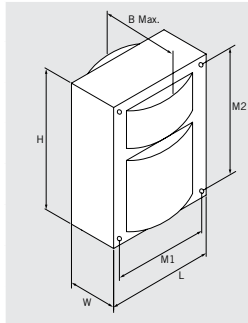

LENGTH	4.30"
WIDTH	5.30"
HEIGHT	6.03"
MOUNTING 1	3.90"
MOUNTING 2	5.37"
B MAX.	8.35"
NET WEIGHT	33 lbs
LEAD LENGTH	12"

CAPACITOR SPECIFICATIONS

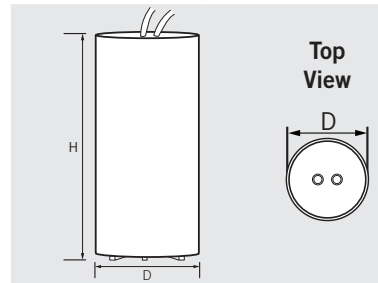

DIAMETER	1.88"
HEIGHT	3.89"
TYPE	Dry Film

IGNITOR SPECIFICATIONS

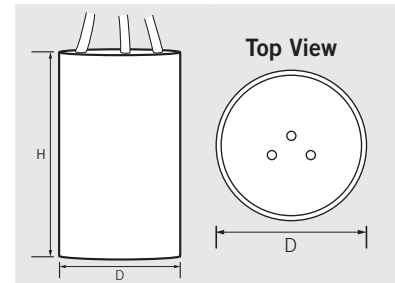

DIAMETER	1.32"
HEIGHT	2.34"
TYPE	CWA

ORDERING INFORMATION

ORDER CODE	PACKAGING STYLE	PACK QTY.	ITEM STATUS
HPS-1000A-P-KIT 3/1	Individually Packaged	1	Quick Ship

Each kit includes the ballast pre-wired to a properly rated capacitor and ignitor (if required), mounting hardware, and pictorial installation guide.

CATALOG NUMBER BREAKDOWN

HPS-1000A-P-KIT

