

# ELECTRONIC FLUORESCENT BALLASTS

## Ballast Life

Philips Advance fluorescent electronic and magnetic ballasts are designed and manufactured to engineering standards correlating to an average life expectancy of 50,000 hours of operation at maximum rated case temperature. Since Philips Advance ballasts operate below their maximum case temperature in the majority of applications, increased ballast life can be expected. As a rule of thumb, ballast life may be doubled for every 10°C reduction in ballast case operating temperature. However, there are many variables, such as input voltage, ambient temperature, etc. which affect ballast operating temperatures, and therefore ballast life.

## Lamp Operating Frequency

Electromagnetic ballasts and the lamps connected to them operate at an input voltage frequency of 60 Hertz (Hz), 60 cycles per second — which is the standard alternating voltage/current frequency provided in North America. Electronic ballasts, on the other hand, convert this 60 Hz input to operate lamps at much higher frequencies above 20 Kilohertz (kHz), 20,000 cycles per second. Philips Advance ballasts operate above 20 kHz, but avoid certain ranges such as 30-40 kHz (infrared) and 54-62 kHz (theft deterrent systems) due to interference issues.

Because electronic ballasts function at high frequency, the fluorescent lighting systems that they operate can convert power to light more efficiently than systems operated by electromagnetic ballasts (See chart below). For example, lamps operated on electronic ballasts can produce over 10 percent more light than if operated on electromagnetic ballasts at the same power levels. In effect, today's electronic ballasts provide additional energy savings by matching the light output from electromagnetic ballasts while operating the lamps at lower power. This is the main reason why electronic ballast systems are more efficient than magnetic ballast system.

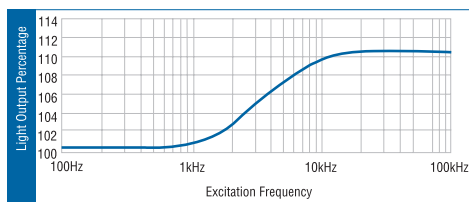

## Crest Factor

Lamp manufacturers use crest factor to determine ballast performance as it relates to lamp life. Lamp Current Crest Factor is a measurement of current supplied by a ballast to start and operate the lamp. It is basically the ratio of peak current to RMS (average) current. High crest factor currents may cause the lamp electrodes to wear out faster, reducing lamp life. Crest factor requirements are regulated by ANSI (American National Standards Institute) standards and specified by lamp manufacturers. For rapid start and instant start T8 lamps the ratio is 1.7 maximum, and for instant start slimline lamps, it is 1.85 maximum.

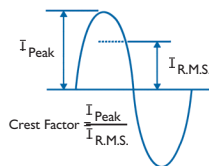

## Weight and Size Advantages

Since electronic components in electronic ballasts are smaller and lighter than the core-and-coil assembly in electromagnetic ballasts, electronic ballasts can weigh less than half as much as comparable

electromagnetic models. Almost all Philips Advance electronic ballasts have a smaller cross-section than electromagnetic ballasts but maintain the same mounting dimensions. This means that they can fit into all new fixture designs and can be easily retrofitted into existing fluorescent lighting systems.

## Controllability

The ability of a building's occupants to control how they light their space is becoming an increasingly important factor for organizations in determining what real estate they will lease, buy or invest in. The ability to dim the lights or easily shut them off completely is a trend fueled not just by a desire to help the environment, but also by significant economic benefits. These benefits include greater energy efficiency — in terms of reduced HVAC costs as well as energy savings for lighting — more comfortable and productive working environments, and compliance with ever tighter energy efficiency regulations. Philips Advance offers three families of electronic controllable ballasts — ROVR, Mark 7 0-10V and Mark 10 Powerline.

## Compatibility With Powerline Carrier Systems

A powerline carrier system (PLC) uses electronic wiring devices to send information via a high frequency signal over the 120V or 277V electrical power distribution system of a building. For example, PLC systems are used in automatic clock systems (master time systems) to synchronize all of the clocks in a building or reset the time after a power outage. They eliminate the need for maintenance personnel to reset hundreds of clocks throughout a facility.

In a PLC system, a generator is used to impose a 1 to 4V high frequency signal on top of the existing voltage sine wave (60 Hz). This signal is generally in the 2500 to 9500Hz range, with some older systems operating at 19,500Hz or higher. Some electronic ballasts which are capacitive can absorb the signal from a PLC system. As a result, the signal becomes too weak to be "heard" by the receiver (like a timeclock) connected to the powerline.

## Instant Start vs. Rapid Start Sockets for Dimming

When using dimming ballasts in fixtures, sockets must be of the Rapid Start type. Many fixtures with T-8 Instant Start electronic ballasts use jumpered or "shunted" Instant Start sockets. Controllable ballasts require two distinctly separate wires for each lamp socket. If you encounter shunted or jumpered sockets in a retrofit application, they must be removed and replaced with Rapid Start sockets.

Improper socket application will damage the ballast and void the ballast warranty.  
Refer to ballast wiring diagram for proper installation.

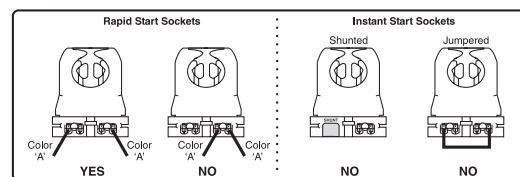

## Fluorescent Lamp Burn-In

Today, most lamp manufacturers do not require the burn-in of linear fluorescent lamps prior to dimming in order to attain rated lamp life and stable electrical measurements. However, some manufacturers compact fluorescent lamp sources do require a 100 hour burn-in prior to dimming. Consult your lamp manufacturer for their latest requirements.

# ELECTRONIC FLUORESCENT BALLASTS

## Ordering Information

### How to Order

Philips Lighting Electronics has developed the industry's broadest distribution system for electronic ballasts. More than 3000 stocking distributors nationwide. For information on the distributor best able to serve your needs, please call 800-372-3331.

### Electronic Ballast Part Number Breakdown

I	CF	-	2	S	26	-	HI	-	LD
CFL Mounting/Connector Options									
BL = Bottom leads									
BLS = Bottom leads with mounting studs									
BS = Bottom mounting studs with single entry color coded connectors									
EL = End leads									
ELS = End leads with mounting studs									
LD = Length mounting feet with SmartMate® dual entry color coded connectors									
LS = Length mounting feet with single entry color coded connectors									
QS = QuikStart									
Linear Fluorescent Mounting/Connector Options									
TP* = Thermal Protected									
2LS = 2 Level Switching									
CFL Can Description									
H1 = Hybrid metal / plastic case, size 1									
L2 = Linear									
M1 = Metal case, size 1									
M2 = Metal case, size 2									
M3 = Metal case, size 3									
M4 = Metal case, size 4									
M5 = Metal case, size 5									
M6 = Metal case, size 6									
N = "N" can									
S1 = Square, style 1									
S2 = Square, style 2									
Linear Fluorescent Can Description									
90C = 90°C maximum case temperature rating									
A = "A" can									
D = "D" can									
G = "G" can									
HL = High light output									
L = "L" can									
LW = Low watt									
MC = Micro can									
RH* = Reduced harmonics									
S = Slimline									
SC = Small can									
Lamp Watts (Primary lamp)									
Wiring Configuration									
D = 2D, series									
M = Modified parallel**									
P = Parallel									
PSP = Programmed Start Parallel									
Q = Quad CFL, series									
S = Series									
T = Triple CFL, series									
TTS = Long twin tube, series									
TTP = Long twin tube, parallel									
Maximum Number of Lamps									
Family Name									
CF = Compact Fluorescent					CN = Centium				
DA = ROVR					DL = ROVR				
EB = AmbiStar					ELB = AmbiStar				
EL = Standard					EZ = Mark 10® Powerline				
IC = Mark 5®					LV = Low Cost 0-10V				
MB = AmbiStar					OP = Optanium				
ZT = Mark 7® 0-10V									
Input Voltage									
G = 347V									
H = IntelliVolt 347V to 480V 50/60 Hz									
I = IntelliVolt 120V to 277V 50/60 Hz									
J = IntelliVolt 277V to 480V 50/60 Hz									
R = 120V									
V = 277V									

Corporate Offices  
(800) 322-2086

Customer Support/Technical Service  
(800) 372-3331  
(+) | 847 390-5000 (International)

Visit our web site at  
[www.philips.com/advance](http://www.philips.com/advance)

- Plan your lighting installation carefully; consider using the services of a qualified lighting designer
- Consult your local electric utility regarding demand side management rebate programs.
- Select the Philips Advance electronic ballast which best matches the requirements of your application. The technical specifications in this catalog (located on pages 9-5 to 9-14) will be useful in obtaining bids from electrical contractors.
- Contact your local Philips Lighting Electronics distributor. You will find them to be a helpful supplier of both products and information.

\* Many current and all future electronic ballast part numbers will not use the "RH-TP" suffixes even though these ballasts will be thermally protected.

\*\* Parallel Wiring Configuration. However, if one lamp fails, all other lamps in the circuit will extinguish.

# ELECTRONIC FLUORESCENT BALLASTS

	Allowed Wiring Configuration			Maximum Lead Length (Feet) for Tandem or Through Wiring (Total length of all wires between ballast and lamp sockets)						Application Note
	Remote (max length)	Tandem	Through	Blue	Red	Yellow	Blue/White	Brown	Orange	
GOPA-1P32-LW-SC (c)	8'	Yes	Yes	8'	8'					1
GOPA-1P32-SC (c)	8'	Yes	Yes	8'	8'					1
GOPA-2P32-LW-SC (c)	8'	Yes	Yes	8'	8'					1
GOPA-2P32-SC (c)	8'	Yes	Yes	8'	8'					1
GOPA-3P32-LW-SC (c)	8'	Yes	Yes	8'	8'					1
GOPA-3P32-SC (c)	8'	Yes	Yes	8'	8'					1
GOPA-4P32-LW-SC (c)	8'	Yes	Yes	8'	8'	8'				1
GOPA-4P32-SC (c)	8'	Yes	Yes	8'	8'	8'				1
HCN-2S54-90C-WL	20'	Yes	Yes	20'	4'	20'				3
HCN-4S54-90C-2LS-G	20'	Yes	Yes	20'	4'	4'	20'	20'	20'	7
ICF-1D38-H1-LD	15'	NA	NA							4
ICF-1H120-M4-LD 2-Lamp	6'	Yes	Yes	2'	6'	6'				2
ICF-2S13-H1-LD 1-Lamp	15'	NA	NA							4
ICF-2S13-M1-BS										
ICF-2S18-H1-LD 1-Lamp	15'	NA	NA							4
ICF-2S18-M1-BS										
ICF-2S26-H1-LD 1-Lamp	15'	NA	NA							4
ICF-2S26-M1-BS										
ICF-2S42-M2-BS 1-Lamp	15'	NA	NA							4
ICF-2S42-M2-LD										
ICF-2S42-90C-M2-BS 1-Lamp	15'	NA	NA							4
ICF-2S42-90C-M2-LD										
ICF-2S70-M4-LD	6'	Yes	Yes	2'	6'	6'				2
ICN-132-MC	20'	NA	NA							4
ICN-1P32-N	20'	NA	NA							4
ICN-1S80	20'	NA	NA							4
ICN-1TTP40-SC	20'	NA	NA							4
ICN-2M32-MC	20'	Yes	Yes	20'	20'					1
ICN-2P32-N	20'	Yes	Yes	20'	20'					1e
ICN-2P60-SC	20'	Yes	Yes	20'	20'					1
ICN-2S24	20'	Yes	Yes	20'	4'	20'				3
ICN-2S28	8'	Yes	Yes	8'	4'	8'				3
ICN-2S28-N	10'	Yes	Yes	10'	10'	10'				3
ICN-2S39	20'	Yes	Yes	20'	4'	20'				3
ICN-2S40-N	20'	Yes	Yes	4'	10'	10'				2
ICN-2S54	20'	Yes	Yes	20'	4'	20'				3
ICN-2S54-WL	20'	Yes	Yes	20'	4'	20'				3
ICN-2S54-90C	20'	Yes	Yes	20'	4'	20'				3
ICN-2S54-90C-SC	20'	Yes	Yes	20'	4'	20'				3
ICN-2S54-90C-WL	20'	Yes	Yes	20'	4'	20'				3
ICN-2S86 (b)	12'	Yes	Yes	12'	4'	12'				3
ICN-2S110-SC	20'	Yes	Yes	4'	20'	20'				2
ICN-2TTP40-SC	20'	Yes	Yes	20'	20'					1
ICN-3P32-SC	20'	Yes	Yes	20'	20'					1e
ICN-3S14-D	No	No	No							5
ICN-3TTP40-SC	20'	Yes	Yes	20'	20'					1
ICN-4P32-SC	20'	Yes	Yes	20'	20'	20'				1e

For nominal input voltage and 25°C ambient temperature. See all notes on page I-19.



# For 54-80W Lamps

HIGH POWER FACTOR SOUND RATED A



Electronic  
Fluorescent Ballasts

No. of Lamps	Input Volts	Lamp Starting Method	Ballast Family	Catalog Number	Input Power ANSI (Watts)	Ballast Factor	Max. THD %	Line Current (Amps)	Min. Starting Temp. (°F/°C)	Dim.	Wiring Dia.
<b>F54T5/HO (54W)</b>											
1	120-277	PS	Centium	ICN-2S54+	62	1.02	10	0.52-0.23	-20/-29	D	73
				ICN-2S54-90C+						B	TBD
	ICN-2S54-90C-SC		L	73							
	Optanium				IOP-2PSP54-SC	60	1.00	10		0.50 - 0.22	
347-480	Centium	HCN-2S54-90C-WL	62	1.02	10	0.18-0.13					
2	120-277	PS	Centium	ICN-2S54+	120-117	1.00	10	1.00-0.43	-20/-29	D	74
				ICN-2S54-90C+						B	TBD
	ICN-2S54-90C-SC		L	74							
	Optanium				IOP-2PSP54-SC	117-114	1.00	10		0.98 - 0.41	
347-480	Centium	HCN-2S54-90C-WL	120-119	1.00	10	0.35-0.25					
3	120-277	PS	Centium	ICN-4S54-90C-2LS	182-179	1.00	10	1.52-0.66	-20/-29	E	75A
				ICN-4S54-90C-2LS-G						G	TBD
	347-480		Optanium	IOP-4PSP54-2LS-G	176-174	1.00	10	1.47-0.83			
4	120-277	PS	Centium	ICN-4S54-90C-2LS	240-234	1.00	10	2.00-0.86	-20/-29	E	75
				ICN-4S54-90C-2LS-G						G	TBD
	347-480		Optanium	IOP-4PSP54-2LS-G	235-229	1.00	10	1.96-0.83			
			Centium	HCN-4S54-90C-2LS-G	239-237	1.00	10	0.69-0.50			75
<b>F80T5/HO (80W)</b>											
1	120-277	PS	Centium	ICN-1S80	91-89	1.00	10	0.76-0.33	0/-18	D	73

+ Also available with leads (ICN-2S24-WL, ICN-2S54-WL or ICN-2S54-90C-WL)

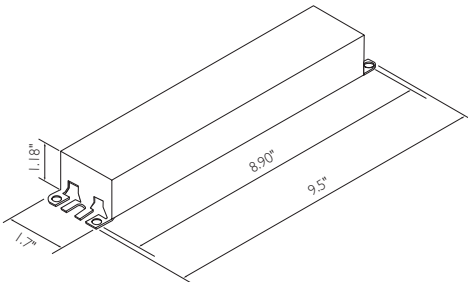

Fig. B

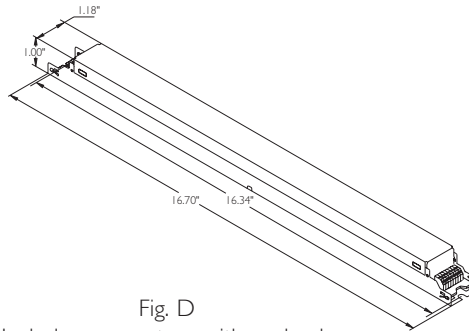

Fig. D  
Includes connectors with no leads

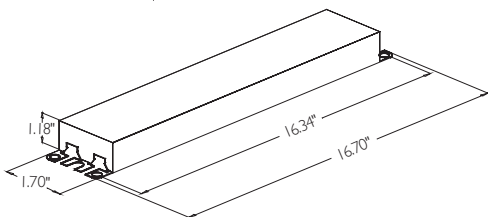

Fig. G

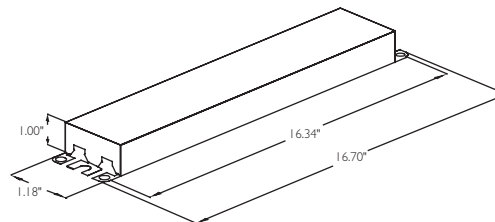

Fig. L

Refer to page I-37 and I-38 for wiring diagrams  
Refer to pages 9-24 to 9-28 for lead lengths and shipping data

# ELECTRONIC FLUORESCENT BALLASTS

## Ballast Life

Philips Advance fluorescent electronic and magnetic ballasts are designed and manufactured to engineering standards correlating to an average life expectancy of 50,000 hours of operation at maximum rated case temperature. Since Philips Advance ballasts operate below their maximum case temperature in the majority of applications, increased ballast life can be expected. As a rule of thumb, ballast life may be doubled for every 10°C reduction in ballast case operating temperature. However, there are many variables, such as input voltage, ambient temperature, etc. which affect ballast operating temperatures, and therefore ballast life.

## Lamp Operating Frequency

Electromagnetic ballasts and the lamps connected to them operate at an input voltage frequency of 60 Hertz (Hz), 60 cycles per second — which is the standard alternating voltage/current frequency provided in North America. Electronic ballasts, on the other hand, convert this 60 Hz input to operate lamps at much higher frequencies above 20 Kilohertz (kHz), 20,000 cycles per second. Philips Advance ballasts operate above 20 kHz, but avoid certain ranges such as 30-40 kHz (infrared) and 54-62 kHz (theft deterrent systems) due to interference issues.

Because electronic ballasts function at high frequency, the fluorescent lighting systems that they operate can convert power to light more efficiently than systems operated by electromagnetic ballasts (See chart below). For example, lamps operated on electronic ballasts can produce over 10 percent more light than if operated on electromagnetic ballasts at the same power levels. In effect, today's electronic ballasts provide additional energy savings by matching the light output from electromagnetic ballasts while operating the lamps at lower power. This is the main reason why electronic ballast systems are more efficient than magnetic ballast system.

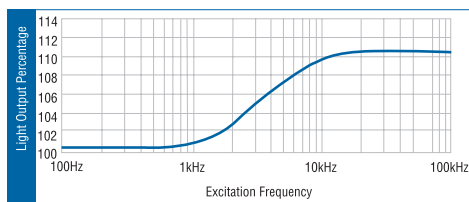

## Crest Factor

Lamp manufacturers use crest factor to determine ballast performance as it relates to lamp life. Lamp Current Crest Factor is a measurement of current supplied by a ballast to start and operate the lamp. It is basically the ratio of peak current to RMS (average) current. High crest factor currents may cause the lamp electrodes to wear out faster, reducing lamp life. Crest factor requirements are regulated by ANSI (American National Standards Institute) standards and specified by lamp manufacturers. For rapid start and instant start T8 lamps the ratio is 1.7 maximum, and for instant start slimline lamps, it is 1.85 maximum.

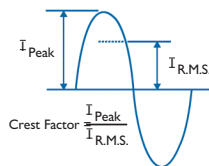

## Weight and Size Advantages

Since electronic components in electronic ballasts are smaller and lighter than the core-and-coil assembly in electromagnetic ballasts, electronic ballasts can weigh less than half as much as comparable

electromagnetic models. Almost all Philips Advance electronic ballasts have a smaller cross-section than electromagnetic ballasts but maintain the same mounting dimensions. This means that they can fit into all new fixture designs and can be easily retrofitted into existing fluorescent lighting systems.

## Controllability

The ability of a building's occupants to control how they light their space is becoming an increasingly important factor for organizations in determining what real estate they will lease, buy or invest in. The ability to dim the lights or easily shut them off completely is a trend fueled not just by a desire to help the environment, but also by significant economic benefits. These benefits include greater energy efficiency — in terms of reduced HVAC costs as well as energy savings for lighting — more comfortable and productive working environments, and compliance with ever tighter energy efficiency regulations. Philips Advance offers three families of electronic controllable ballasts — ROVR, Mark 7 0-10V and Mark 10 Powerline.

## Compatibility With Powerline Carrier Systems

A powerline carrier system (PLC) uses electronic wiring devices to send information via a high frequency signal over the 120V or 277V electrical power distribution system of a building. For example, PLC systems are used in automatic clock systems (master time systems) to synchronize all of the clocks in a building or reset the time after a power outage. They eliminate the need for maintenance personnel to reset hundreds of clocks throughout a facility.

In a PLC system, a generator is used to impose a 1 to 4V high frequency signal on top of the existing voltage sine wave (60 Hz). This signal is generally in the 2500 to 9500Hz range, with some older systems operating at 19,500Hz or higher. Some electronic ballasts which are capacitive can absorb the signal from a PLC system. As a result, the signal becomes too weak to be "heard" by the receiver (like a timeclock) connected to the powerline.

## Instant Start vs. Rapid Start Sockets for Dimming

When using dimming ballasts in fixtures, sockets must be of the Rapid Start type. Many fixtures with T-8 Instant Start electronic ballasts use jumpered or "shunted" Instant Start sockets. Controllable ballasts require two distinctly separate wires for each lamp socket. If you encounter shunted or jumpered sockets in a retrofit application, they must be removed and replaced with Rapid Start sockets.

Improper socket application will damage the ballast and void the ballast warranty. Refer to ballast wiring diagram for proper installation.

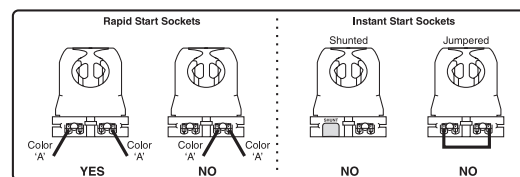

## Fluorescent Lamp Burn-In

Today, most lamp manufacturers do not require the burn-in of linear fluorescent lamps prior to dimming in order to attain rated lamp life and stable electrical measurements. However, some manufacturers compact fluorescent lamp sources do require a 100 hour burn-in prior to dimming. Consult your lamp manufacturer for their latest requirements.

# ELECTRONIC FLUORESCENT BALLASTS

## Ordering Information

### How to Order

Philips Lighting Electronics has developed the industry's broadest distribution system for electronic ballasts. More than 3000 stocking distributors nationwide. For information on the distributor best able to serve your needs, please call 800-372-3331.

### Electronic Ballast Part Number Breakdown

I	CF	-	2	S	26	-	HI	-	LD
CFL Mounting/Connector Options									
BL = Bottom leads									
BLS = Bottom leads with mounting studs									
BS = Bottom mounting studs with single entry color coded connectors									
EL = End leads									
ELS = End leads with mounting studs									
LD = Length mounting feet with SmartMate® dual entry color coded connectors									
LS = Length mounting feet with single entry color coded connectors									
QS = QuikStart									
Linear Fluorescent Mounting/Connector Options									
TP* = Thermal Protected									
2LS = 2 Level Switching									
CFL Can Description									
H1 = Hybrid metal / plastic case, size 1									
L2 = Linear									
M1 = Metal case, size 1									
M2 = Metal case, size 2									
M3 = Metal case, size 3									
M4 = Metal case, size 4									
M5 = Metal case, size 5									
M6 = Metal case, size 6									
N = "N" can									
S1 = Square, style 1									
S2 = Square, style 2									
Linear Fluorescent Can Description									
90C = 90°C maximum case temperature rating									
A = "A" can									
D = "D" can									
G = "G" can									
HL = High light output									
L = "L" can									
LW = Low watt									
MC = Micro can									
RH* = Reduced harmonics									
S = Slimline									
SC = Small can									
Lamp Watts (Primary lamp)									
Wiring Configuration									
D = 2D, series									
M = Modified parallel**									
P = Parallel									
PSP = Programmed Start Parallel									
Q = Quad CFL, series									
S = Series									
T = Triple CFL, series									
TTS = Long twin tube, series									
TTP = Long twin tube, parallel									
Maximum Number of Lamps									
Family Name									
CF = Compact Fluorescent					CN = Centium				
DA = ROVR					DL = ROVR				
EB = AmbiStar					ELB = AmbiStar				
EL = Standard					EZ = Mark 10® Powerline				
IC = Mark 5®					LV = Low Cost 0-10V				
MB = AmbiStar					OP = Optanium				
ZT = Mark 7® 0-10V									
Input Voltage									
G = 347V									
H = IntelliVolt 347V to 480V 50/60 Hz									
I = IntelliVolt 120V to 277V 50/60 Hz									
J = IntelliVolt 277V to 480V 50/60 Hz									
R = 120V									
V = 277V									

Corporate Offices  
(800) 322-2086

Customer Support/Technical Service  
(800) 372-3331  
(+) | 847 390-5000 (International)

Visit our web site at  
[www.philips.com/advance](http://www.philips.com/advance)

- Plan your lighting installation carefully; consider using the services of a qualified lighting designer
- Consult your local electric utility regarding demand side management rebate programs.
- Select the Philips Advance electronic ballast which best matches the requirements of your application. The technical specifications in this catalog (located on pages 9-5 to 9-14) will be useful in obtaining bids from electrical contractors.
- Contact your local Philips Lighting Electronics distributor. You will find them to be a helpful supplier of both products and information.

\* Many current and all future electronic ballast part numbers will not use the "RH-TP" suffixes even though these ballasts will be thermally protected.

\*\* Parallel Wiring Configuration. However, if one lamp fails, all other lamps in the circuit will extinguish.

# ELECTRONIC FLUORESCENT BALLASTS

	Allowed Wiring Configuration			Maximum Lead Length (Feet) for Tandem or Through Wiring (Total length of all wires between ballast and lamp sockets)						Application Note
	Remote (max length)	Tandem	Through	Blue	Red	Yellow	Blue/White	Brown	Orange	
GOPA-1P32-LW-SC (c)	8'	Yes	Yes	8'	8'					1
GOPA-1P32-SC (c)	8'	Yes	Yes	8'	8'					1
GOPA-2P32-LW-SC (c)	8'	Yes	Yes	8'	8'					1
GOPA-2P32-SC (c)	8'	Yes	Yes	8'	8'					1
GOPA-3P32-LW-SC (c)	8'	Yes	Yes	8'	8'					1
GOPA-3P32-SC (c)	8'	Yes	Yes	8'	8'					1
GOPA-4P32-LW-SC (c)	8'	Yes	Yes	8'	8'	8'				1
GOPA-4P32-SC (c)	8'	Yes	Yes	8'	8'	8'				1
HCN-2S54-90C-WL	20'	Yes	Yes	20'	4'	20'				3
HCN-4S54-90C-2LS-G	20'	Yes	Yes	20'	4'	4'	20'	20'	20'	7
ICF-1D38-H1-LD	15'	NA	NA							4
ICF-1H120-M4-LD 2-Lamp	6'	Yes	Yes	2'	6'	6'				2
ICF-2S13-H1-LD 1-Lamp	15'	NA	NA							4
ICF-2S13-M1-BS										
ICF-2S18-H1-LD 1-Lamp	15'	NA	NA							4
ICF-2S18-M1-BS										
ICF-2S26-H1-LD 1-Lamp	15'	NA	NA							4
ICF-2S26-M1-BS										
ICF-2S42-M2-BS 1-Lamp	15'	NA	NA							4
ICF-2S42-M2-LD										
ICF-2S42-90C-M2-BS 1-Lamp	15'	NA	NA							4
ICF-2S42-90C-M2-LD										
ICF-2S70-M4-LD	6'	Yes	Yes	2'	6'	6'				2
ICN-132-MC	20'	NA	NA							4
ICN-1P32-N	20'	NA	NA							4
ICN-1S80	20'	NA	NA							4
ICN-1TTP40-SC	20'	NA	NA							4
ICN-2M32-MC	20'	Yes	Yes	20'	20'					1
ICN-2P32-N	20'	Yes	Yes	20'	20'					1e
ICN-2P60-SC	20'	Yes	Yes	20'	20'					1
ICN-2S24	20'	Yes	Yes	20'	4'	20'				3
ICN-2S28	8'	Yes	Yes	8'	4'	8'				3
ICN-2S28-N	10'	Yes	Yes	10'	10'	10'				3
ICN-2S39	20'	Yes	Yes	20'	4'	20'				3
ICN-2S40-N	20'	Yes	Yes	4'	10'	10'				2
ICN-2S54	20'	Yes	Yes	20'	4'	20'				3
ICN-2S54-WL	20'	Yes	Yes	20'	4'	20'				3
ICN-2S54-90C	20'	Yes	Yes	20'	4'	20'				3
ICN-2S54-90C-SC	20'	Yes	Yes	20'	4'	20'				3
ICN-2S54-90C-WL	20'	Yes	Yes	20'	4'	20'				3
ICN-2S86 (b)	12'	Yes	Yes	12'	4'	12'				3
ICN-2S110-SC	20'	Yes	Yes	4'	20'	20'				2
ICN-2TTP40-SC	20'	Yes	Yes	20'	20'					1
ICN-3P32-SC	20'	Yes	Yes	20'	20'					1e
ICN-3S14-D	No	No	No							5
ICN-3TTP40-SC	20'	Yes	Yes	20'	20'					1
ICN-4P32-SC	20'	Yes	Yes	20'	20'	20'				1e

For nominal input voltage and 25°C ambient temperature. See all notes on page I-19.



# For 54-80W Lamps

HIGH POWER FACTOR SOUND RATED A



Electronic  
Fluorescent Ballasts

No. of Lamps	Input Volts	Lamp Starting Method	Ballast Family	Catalog Number	Input Power ANSI (Watts)	Ballast Factor	Max. THD %	Line Current (Amps)	Min. Starting Temp. (°F/°C)	Dim.	Wiring Dia.
<b>F54T5/HO (54W)</b>											
1	120-277	PS	Centium	ICN-2S54+	62	1.02	10	0.52-0.23	-20/-29	D	73
				ICN-2S54-90C+						B	TBD
	ICN-2S54-90C-SC		L	73							
	Optanium		IOP-2PSP54-SC	60	1.00	10	0.50 - 0.22				
347-480	Centium	HCN-2S54-90C-WL	62	1.02	10	0.18-0.13					
2	120-277	PS	Centium	ICN-2S54+	120-117	1.00	10	1.00-0.43	-20/-29	D	74
				ICN-2S54-90C+						B	TBD
	ICN-2S54-90C-SC		L	74							
	Optanium		IOP-2PSP54-SC	117-114	1.00	10	0.98 - 0.41				
347-480	Centium	HCN-2S54-90C-WL	120-119	1.00	10	0.35-0.25					
3	120-277	PS	Centium	ICN-4S54-90C-2LS	182-179	1.00	10	1.52-0.66	-20/-29	E	75A
				ICN-4S54-90C-2LS-G						G	TBD
	347-480		Optanium	IOP-4PSP54-2LS-G	176-174	1.00	10	1.47-0.83		75	
4	120-277	PS	Centium	ICN-4S54-90C-2LS	240-234	1.00	10	2.00-0.86	-20/-29	E	75
				ICN-4S54-90C-2LS-G						G	TBD
	347-480		Optanium	IOP-4PSP54-2LS-G	235-229	1.00	10	1.96-0.83		75	
			Centium	HCN-4S54-90C-2LS-G	239-237	1.00	10	0.69-0.50			
<b>F80T5/HO (80W)</b>											
I	120-277	PS	Centium	ICN-1S80	91-89	1.00	10	0.76-0.33	0/-18	D	73

+ Also available with leads (ICN-2S24-WL, ICN-2S54-WL or ICN-2S54-90C-WL)

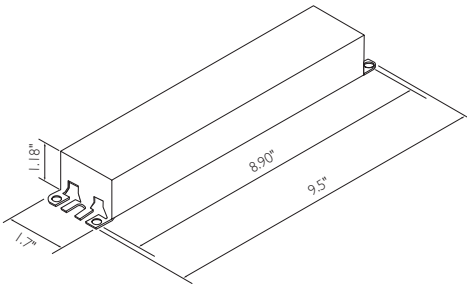

Fig. B

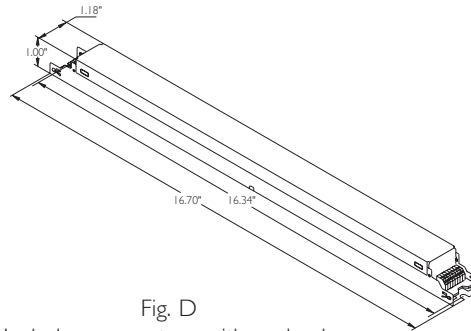

Fig. D  
Includes connectors with no leads

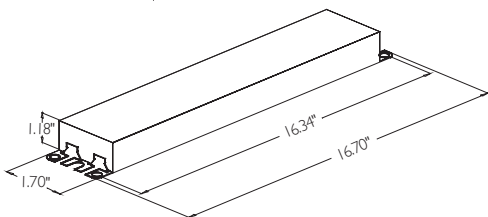

Fig. G

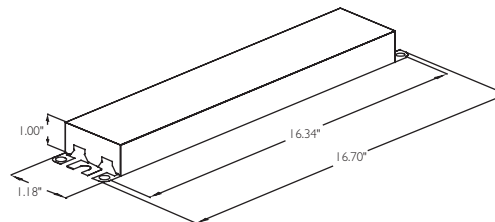

Fig. L

Refer to page I-37 and I-38 for wiring diagrams  
Refer to pages 9-24 to 9-28 for lead lengths and shipping data