

CATALOG NUMBER	AWG				CATALOG NUMBER	METRIC WIRE SIZE				RECOMMENDED TIGHTENING TORQUE IN-LBS [N-m]	LETTERING LOCATOR TYPE
	RANGE FOR EQUAL RUN & TAP (COPPER)			MINIMUM TAP WITH MAXIMUM CABLE RUN		RANGE FOR EQUAL RUN & TAP (COPPER)			MINIMUM TAP WITH MAXIMUM CABLE RUN		
	MAX. SOLID CONDUCTOR	MINIMUM	MAXIMUM			MAX SOLID CONDUCTOR	MINIMUM	MAXIMUM			
KS15	#8 SOL (.129)	#10 STR (.116)	#8 STR (.146)	#14 STR (.073)	KS15	10mm ² SOL [3.2]	6mm ² STR [3.3]	10mm ² STR [4.0]	2.5mm ² STR [2.2]	80 [9]	C
KS17	#6 SOL (.162)	#8 STR (.146)	#6 STR (.184)	#14 STR (.073)	KS17	16mm ² SOL [4.0]	10mm ² STR [4.0]	10mm ² STR [4.0]	2.5mm ² STR [2.2]	165 [18.6]	C
KS20	#4 SOL (.204)	#8 STR (.146)	#4 STR (.232)	#14 STR (.073)	KS20	-----	10mm ² STR [4.0]	16mm ² STR [5.1]	2.5mm ² STR [2.2]	165 [18.6]	A
KS22	#2 SOL (.258)	#6 STR (.184)	#3 STR (.260)	#14 STR (.073)	KS22	-----	16mm ² STR [5.1]	25mm ² STR [6.3]	2.5mm ² STR [2.2]	275 [31.1]	A
KS23	#1 SOL (.289)	#6 STR (.184)	#2 STR (.292)	#14 STR (.073)	KS23	-----	16mm ² STR [5.1]	35mm ² STR [7.5]	2.5mm ² STR [2.2]	275 [31.1]	A
KS25	2/0 SOL (.365)	#4 STR (.232)	1/0 STR (.373)	#14 STR (.073)	KS25	-----	25mm ² STR [6.3]	50mm ² STR [9.0]	2.5mm ² STR [2.2]	385 [43.5]	A
KS26	3/0 SOL (.410)	#2 STR (.292)	2/0 STR (.418)	#14 STR (.073)	KS26	-----	35mm ² STR [7.5]	70mm ² STR [10.5]	2.5mm ² STR [2.2]	385 [43.5]	A
KS27	4/0 SOL (.460)	#1 STR (.332)	3/0 STR (.470)	#8 SOL (.129)	KS27	-----	50mm ² STR [9.0]	95mm ² STR [12.5]	10mm ² SOL [3.2]	500 [56.5]	A
KS29	4/0 SOL (.460)	#1 STR (.332)	250 Kcmil (.575)	#8 STR (.146)	KS29	-----	50mm ² STR [9.0]	120mm ² STR [14.0]	10mm ² STR [4.0]	650 [73.4]	A
KS31	-----	1/0 STR (.373)	350 Kcmil (.681)	1/0 STR (.373)	KS31	-----	70mm ² STR [10.5]	185mm ² STR [17.5]	70mm ² STR [10.5]	650 [73.4]	B
KS34	-----	2/0 STR (.418)	500 Kcmil (.814)	2/0 STR (.418)	KS34	-----	70mm ² STR [10.5]	240mm ² STR [20.6]	70mm ² STR [10.5]	825 [93.2]	B
KS39	-----	4/0 STR (.528)	750 Kcmil (.998)	4/0 STR (.528)	KS39	-----	120mm ² STR [14.0]	300mm ² STR [22.5]	120mm ² STR [14.0]	1000 [113.0]	B
KS44	-----	300 Kcmil (.630)	1000 Kcmil (1.152)	4/0 STR (.528)	KS44	-----	150mm ² STR [15.7]	500mm ² STR [29.1]	120mm ² STR [14.0]	1100 [124.3]	B
KS90	#8 SOL (.129)	#12 STR (.092)	#10 STR (.116)	#16 STR (.058)	KS90	-----	4mm ² STR [2.3]	6mm ² STR [3.3]	1.5mm ² STR [1.4]	80 [4]	C

REV	DATE	DESCRIPTION	ECO	BY	CHK.
J	2017-12-20 17:00:00 EST	UPDATED AS PER WORKUP	48235	YR	VS

C

B

A

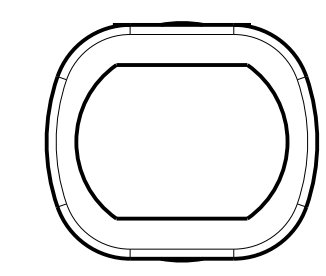

TYPICAL LETTERING TYPE A

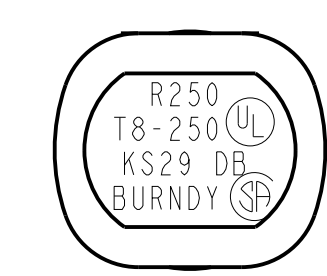
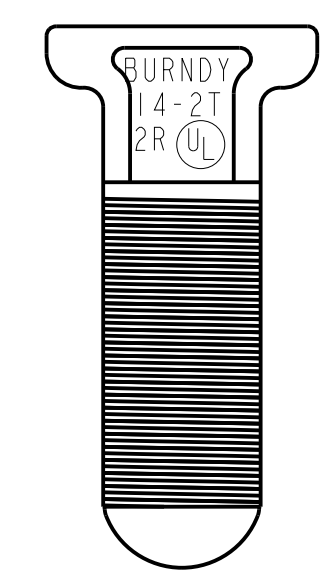
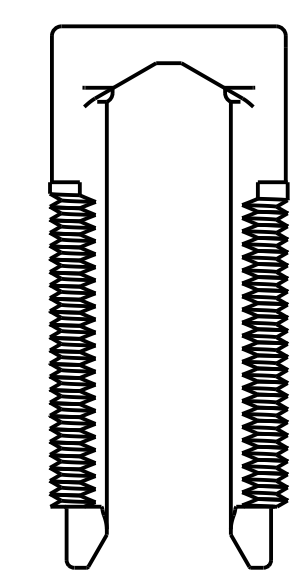
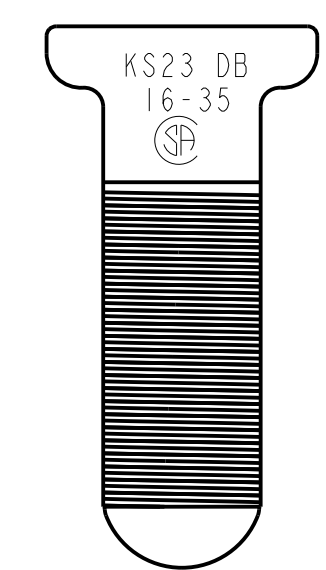

TYPICAL LETTERING TYPE B

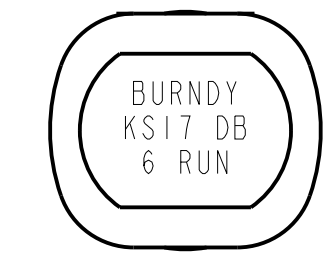
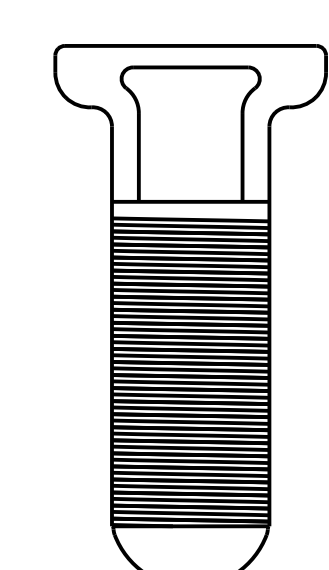
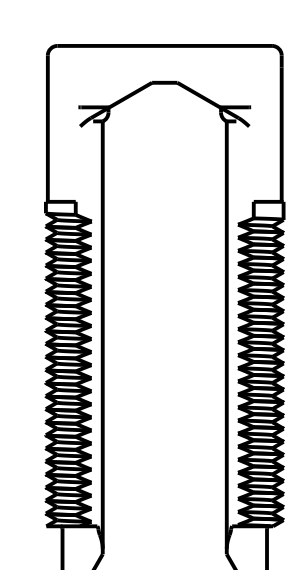
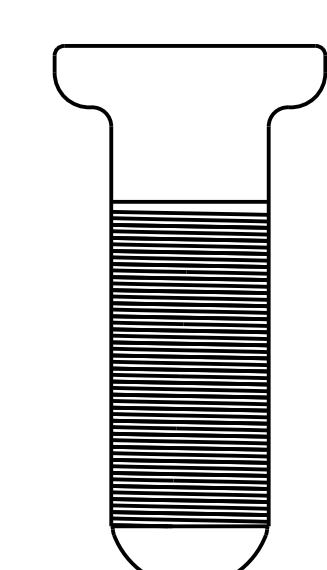

TYPICAL LETTERING TYPE C

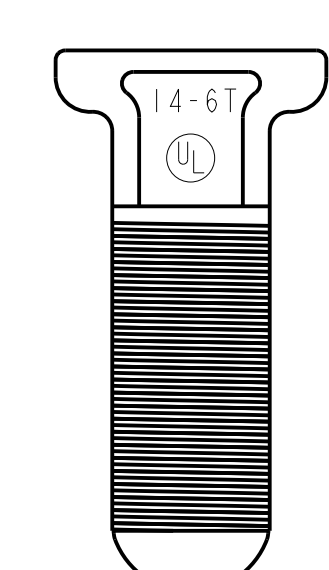
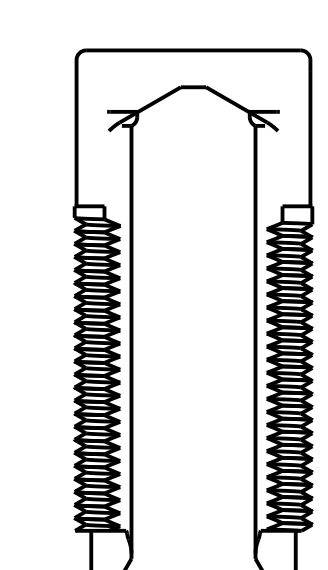
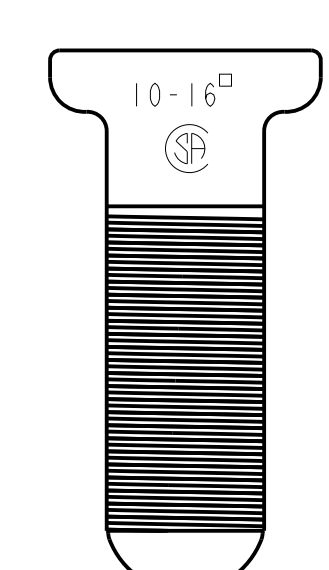

NOTES:

- MATERIAL: COPPER ALLOY
- DIMENSIONS IN BRACKET [] ARE IN MILLIMETERS ROUNDED OFF TO THE NEAREST MILLIMETER, UNLESS OTHERWISE NOTED, AND ARE FOR REFERENCE ONLY.
- UL 486A LISTED. FILE NO. E9498.
- CSA C22.2 NO. 65 LISTED. FILE NO. 42862.
- UL467 LISTED, FILE NO. E9999. SUITABLE FOR DIRECT BURIAL, THIS DOES NOT APPLY TO KS39 OR KS44.
- CSA C22.2 NO.41 CERTIFIED. SUITABLE FOR DIRECT BURIAL, THIS DOES NOT APPLY TO KS39 OR KS44.
- THIS DRAWING TO BE INTERPRETED PER ASME Y14.5M-2009.
- LISTED TORQUE VALUES ARE FOR MAXIMUM CONDUCTOR COMBINATIONS. CONSULT UL486 A-B TABLES 21, 22, 23, FOR SMALLER CONDUCTOR COMBINATIONS.
- TIN PLATED BODY AND NUT VARIATIONS ARE AVAILABLE BY ADDING THE SUFFIX "TN" TO THE CATALOG NUMBER.
- NICKLE PLATED BODY AND NUT VARIATIONS ARE AVAILABLE BY ADDING THE SUFFIX "NK" TO THE CATALOG NUMBER.

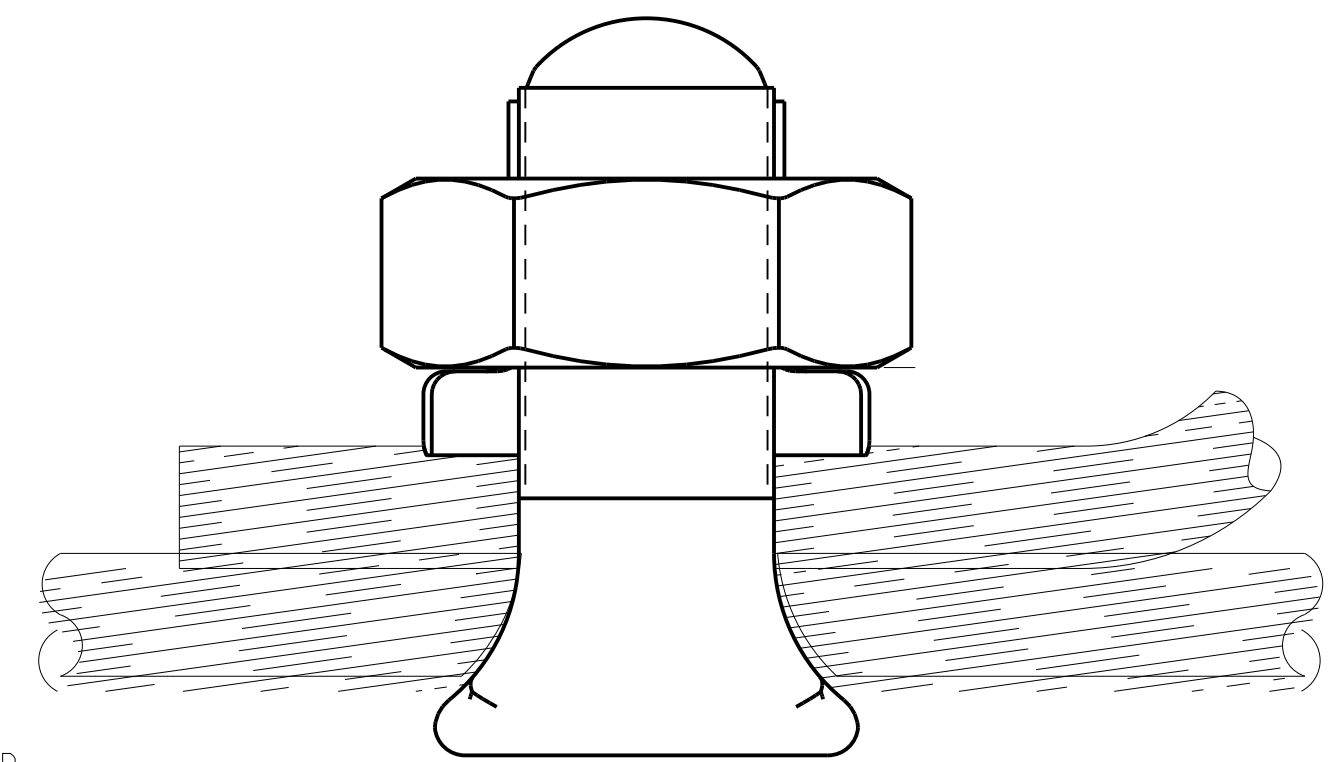

TO ORDER BURNDY® PRODUCTS CALL
 UNITED STATES
 1-800-346-4175 (LONDONDERRY, NH)
 CANADA:
 1-800-361-6975 (QUEBEC)
 1-800-387-6487 (ALL OTHER PROVINCES)
 FOR PRODUCT INFO: <http://www.burndy.com>

SERVIT™			
ITEM NO:	SEE TABLE		
CAT. NO:	KS-- (TABLE)		
DRAWN BY:	D DOBRINSKI 08/11/10		
CHECKER:	J HALL 08/10/10		
DSN APPVL:	R LAVOIE 02/10/17		
MFG APPVL:	J HAWRZYNIAK 02/07/17		
QA APPVL:	J HILLMAN 02/08/17		
MKT APPVL:	B CRUTCHER 02/07/17		
PROD FAM:	SERVITS	DRAWING NO:	SD078561
PROJECT #:	--	SCALE:	1:1
DOCUMENT TYPE:	Sales	REV:	J
REL LEVEL:	Released	SHEET 1 OF 2	



REV: PEC200

REV	DATE	DESCRIPTION	ECO	BY	C'H'K.
J	2017-12-20 17:00:00 EST	UPDATED AS PER MARKUP	48235	YR	VS

CATALOG NUMBER	B	C.F.	J	L	R	V	W
KS15	.45 [11]	.50 [13]	3/8"-24NF-2	.85 [22]	.38 [10]	.14 [4]	.57 [15]
KS17	.58 [15]	.63 [16]	7/16"-20NF-2	1.14 [30]	.45 [11]	.16 [4]	.70 [18]
KS20	.65 [17]	.64 [16]	1/2"-20NF-2	1.20 [31]	.51 [13]	.22 [6]	.78 [20]
KS22	.69 [18]	.75 [19]	19/32"-20NS-2	1.50 [38]	.60 [15]	.26 [7]	.84 [21]
KS23	.72 [18]	.82 [21]	5/8"-18UNF-2	1.54 [39]	.62 [16]	.32 [8]	.92 [23]
KS25	.81 [21]	.94 [24]	3/4"-16UNF-2	1.77 [45]	.73 [19]	.38 [10]	1.06 [27]
KS26	.90 [23]	1.05 [27]	7/8"-14UNF-2	1.94 [49]	.82 [21]	.44 [11]	1.18 [30]
KS27	.90 [23]	1.05 [27]	7/8"-14UNF-2	1.94 [49]	.82 [21]	.48 [12]	1.18 [30]
KS29	1.00 [25]	1.39 [35]	1 1/8"-12NF-2	2.25 [57]	1.00 [25]	.60 [15]	1.56 [37]
KS31	1.25 [32]	1.70 [43]	1 3/8"-12UNF-2	2.60 [66]	1.41 [36]	.71 [18]	1.96 [50]
KS34	1.31 [33]	1.82 [46]	1 7/16"-12UN-2	2.83 [72]	1.53 [39]	.85 [22]	2.10 [53]
KS39	1.75 [45]	2.31 [59]	1 7/8"-12UN-2	3.51 [89]	1.94 [49]	1.02 [26]	2.62 [67]
KS44	2.10 [53]	2.56 [65]	2 1/8"-12UN-2	3.90 [99]	2.19 [56]	1.17 [28]	2.91 [74]
KS90	.45 [11]	.50 [13]	3/8"-24NF-2	.85 [22]	.38 [10]	.14 [4]	.57 [15]

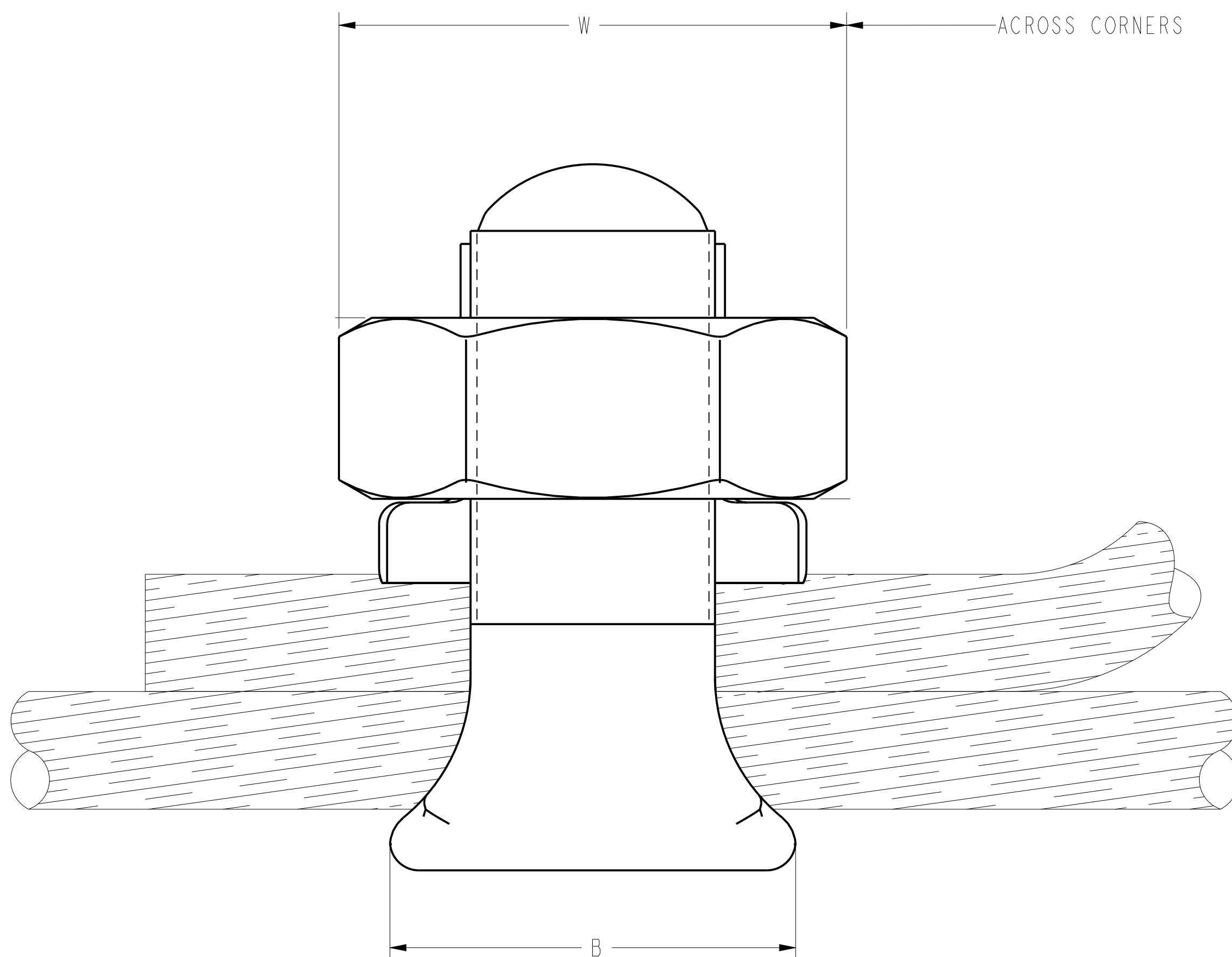
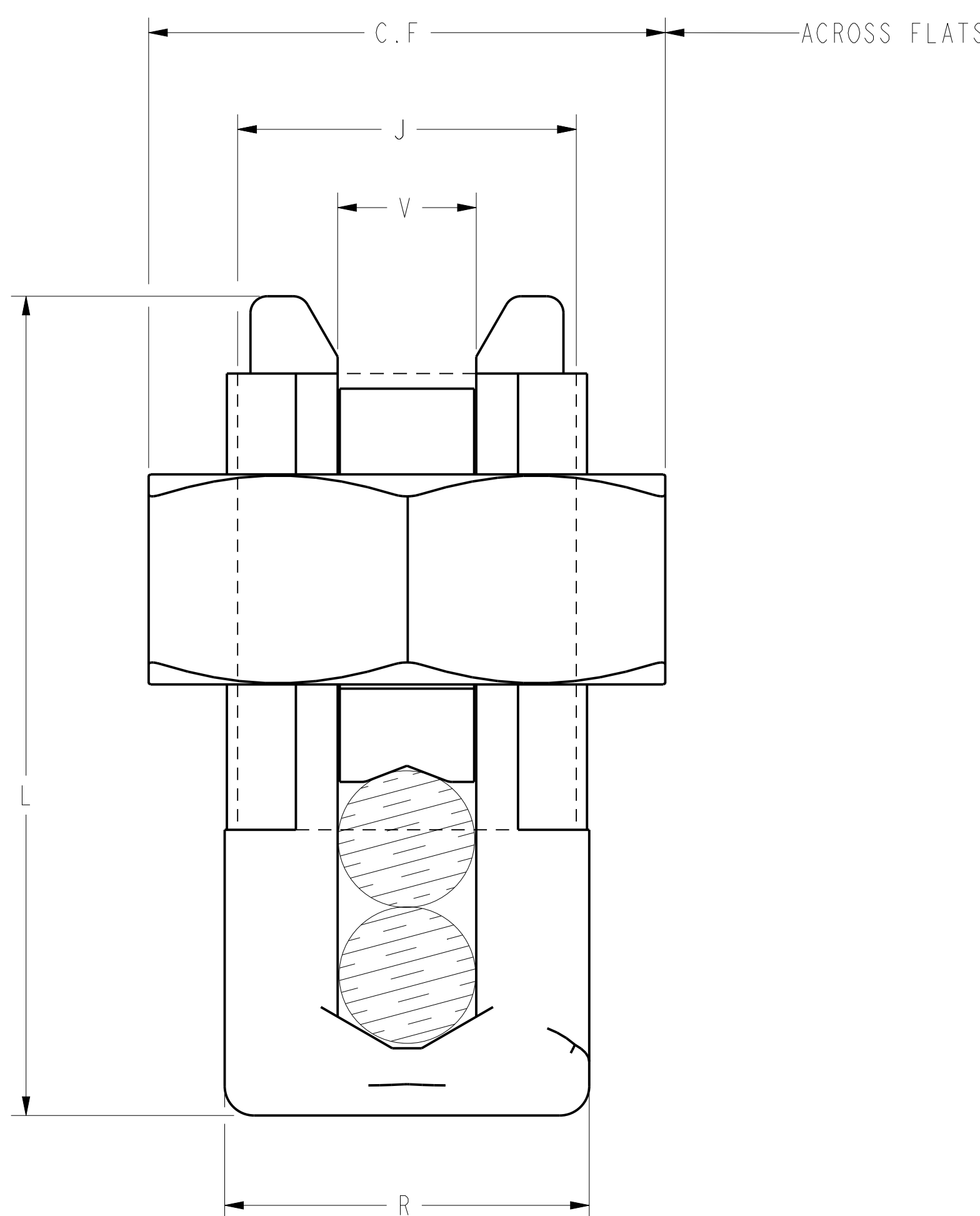

NOTES:

1. MATERIAL: COPPER ALLOY
2. DIMENSIONS IN BRACKET [] ARE IN MILLIMETERS ROUNDED OFF TO THE NEAREST MILLIMETER, UNLESS OTHERWISE NOTED, AND ARE FOR REFERENCE ONLY.
3. UL 486A LISTED. FILE NO. E9498.
4. CSA C22.2 NO. 65 LISTED. FILE NO. 42862.
5. UL467 LISTED, FILE NO. E9999. SUITABLE FOR DIRECT BURIAL, THIS DOES NOT APPLY TO KS39 OR KS44.
6. CSA C22.2 NO. 41 CERTIFIED. SUITABLE FOR DIRECT BURIAL, THIS DOES NOT APPLY TO KS39 OR KS44.
7. THIS DRAWING TO BE INTERPRETED PER ASME Y14.5M-2009.
8. LISTED TORQUE VALUES ARE FOR MAXIMUM CONDUCTOR COMBINATIONS. CONSULT UL486 A-B TABLES 21, 22, 23, FOR SMALLER CONDUCTOR COMBINATIONS.
9. TIN PLATED BODY AND NUT VARIATIONS ARE AVAILABLE BY ADDING THE SUFFIX "TN" TO THE CATALOG NUMBER.
10. NICKLE PLATED BODY AND NUT VARIATIONS ARE AVAILABLE BY ADDING THE SUFFIX "NK" TO THE CATALOG NUMBER.

TO ORDER BURNDY® PRODUCTS CALL		SERVIT™	
UNITED STATES 1-800-346-4175 (LONDONDERRY, NH)		ITEM NO: SEE TABLE	CAT. NO: KS-- (TABLE)
CANADA: 1-800-361-6975 (QUEBEC) 1-800-387-6487 (ALL OTHER PROVINCES)		DRAWN BY: D DOBRINSKI 08/11/10	CHECKER: J HALL 08/10/10
FOR PRODUCT INFO: http://www.burndy.com		DSN APPVL: R LAVOIE 02/10/17	MFG APPVL: T WAWRZYNIAK 02/07/17
		GA APPVL: J HILLMAN 02/08/17	MKT APPVL: B CRUTCHER 02/07/17
		PROD FAM: SERVITS	SCALE: 1:1
		PROJECT #: --	SIZE: D
		DOCUMENT TYPE: Sales	DRAWING NO: SD078561
		REL LEVEL: Released	REV: J
			SHEET 2 OF 2

REV: PEC200