



# KT-LED115HID-V-EX39-850-D

## HID REPLACEMENT LED LAMP

### DESCRIPTION

115W HID Replacement LED Lamp | 5000K | >80 CRI | Vertical Light Direction



<b>LAMP TYPE:</b> HID Replacement LED
<b>BASE TYPE:</b> EX39 (Mogul)
<b>WATTAGE:</b> 115W
<b>COLOR TEMPERATURE:</b> 5000K
<b>METAL HALIDE EQUIVALENT:</b> 400W
<b>COLOR RENDERING INDEX (CRI):</b> >80
<b>WARRANTY:</b> 5 Years



### PRODUCT FEATURES

- Replacement for Conventional Metal Halide Lamp
- Non-Dimmable; Do Not Dim
- 50,000+ Hour Lifetime
- Environmentally Friendly: No Mercury Used
- Instant Startup
- UL Listed
- Suitable for Use in Fully Enclosed Fixture
- Integral Driver, Eliminates the Need for External Driver or Ballast; Includes 6V Surge Protection
- Suitable for Use in Enclosed Fixtures
- Efficacy greater than 130 lm/W
- Listed on the DLC QPL
- IP20 Rated
- Operating Temperature: -29°C/-20°F to 60°C/140°F

### OPERATING SPECIFICATIONS

#### ELECTRICAL CHARACTERISTICS

Input Voltage	Power Consumption	Power Factor	Input Current
120-277Vac	115W	>0.9	0.96A @ 120V 0.42A @ 277V

#### RATED LIFE

L70 (Hours)	50,000
-------------	--------

#### PHOTOMETRIC CHARACTERISTICS

Color Temperature (CCT)	5000K
Luminous Flux	15700 lm
Color Rendering Index (CRI)	>80
Efficacy	137 lm/W
Visible Light Area	180°

#### SPECTRAL DISTRIBUTION

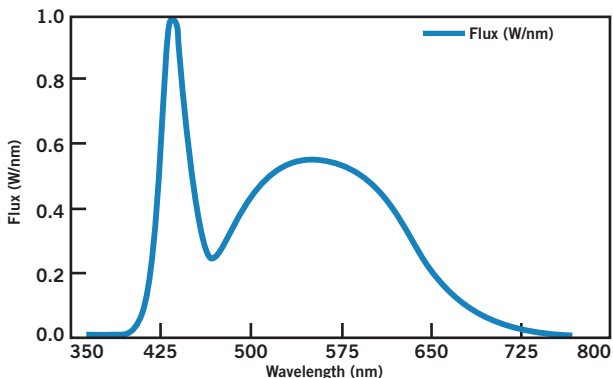

#### LUX DISTANCE CURVE

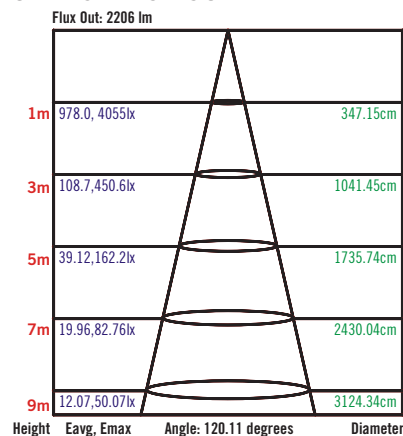

Note: The curves indicate the illuminated area and the average illumination when the luminaire is at a different distance.



# KT-LED115HID-V-EX39-850-D

## HID REPLACEMENT LED LAMP

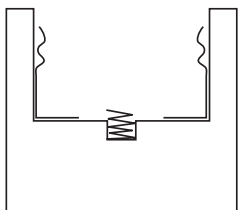

E39 MOGUL SOCKET

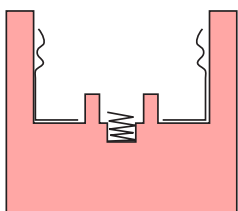

EX39 MOGUL SOCKET

**EX39-based lamps will work in both E39 and EX39 sockets.**

### WIRING DIAGRAM

#### STEP 1

**Disconnect power.** Disconnect and remove existing ballast, capacitor, and/or ignitor (where applicable) from fixture.

#### STEP 2

Rewire for line voltage to the lamp socket.

#### STEP 3

Install new LED replacement lamp. Ensure lamp is operating properly when power is turned on.

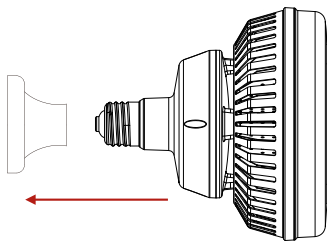

FIGURE 1

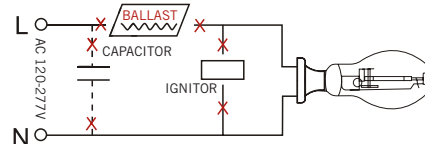

FIGURE 2

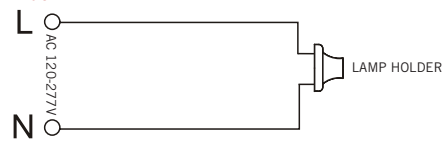
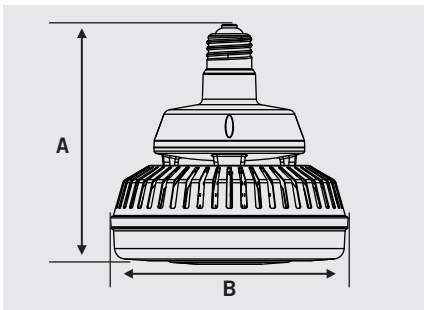

FIGURE 3



### PHYSICAL CHARACTERISTICS



#### LAMP DIMENSIONS

A (Body Length)	8.21"
B (Diameter)	8.07"

BASE TYPE: EX39 (Mogul)

### ORDERING INFORMATION

ORDER CODE	PACKAGING STYLE	PACK QTY.	ITEM STATUS
KT-LED115HID-V-EX39-850-D-DP	Distributor Pack (Individual Cartons)	TBD	Quick Ship

### CATALOG NUMBER BREAKDOWN

# KT-LED115-V-HID-EX39-850-D-DP

