

**L1420, L1520, L1620, L1820, L1430, L1530, L1630, L1830**
**Tough enough for industrial environments.**

Every component of these durable Turnlok locking plugs and connectors are built to offer the lowest installed cost with maximum durability. Quick-thread assembly screws install four times faster than competitive product and backed-out screws come ready-to-wire. The rugged easy-to-grip nylon housing, clear thermoplastic terminal chambers as well as high-strength brass alloy blades and contacts combine to give Legrand the premium selection of P&S Turnlok plugs and connectors.

**FEATURES & BENEFITS**

**Rounded back contour** reduces snags and hang-ups on the job site.

**Visible stamped NEMA configuration and device rating.**

**Raised ribs** provide non-slip gripping profile for turning to lock and unlock.

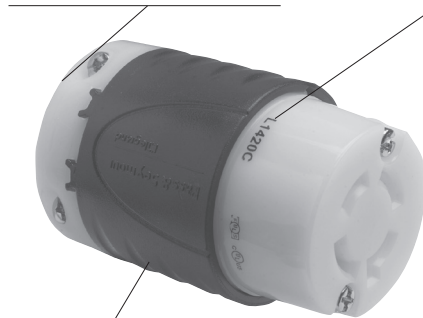

**Industrial-strength, brass alloy plug blades** and connector contacts resist heat rise, provide excellent conductivity.

**Double dovetail design** provides superior protection against cord pull-out forces.

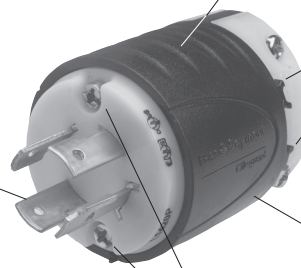

**Scallop shell design** provides non-slip gripping surface for insertion and withdrawal.

**Impact- and corrosion-resistant** durable nylon 6/6 shell material.

**L1420C & L1420P**

**Quick-thread assembly screws** and cord-grip screws come backed-out, ready-to-wire. Installs four times faster.

**External cord grips** provide visible assurance of safe and proper cord retention.

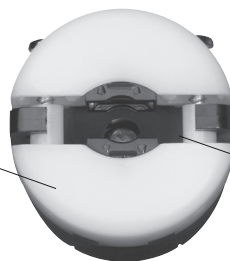

**Integral flexible rubber cord grommet** conforms to and seals around SO cord to provide protection from oils, water, or chips entering wiring chamber.

**FIELD USES/VERTICAL MARKETS**

- Industrial
- Health Care
- Education
- Institutional
- Retail
- Office
- Hospitality/Lodging

### ORDERING INFORMATION

Catalog Number	Rating A. V.	Description/Color	Cord Diameter	NEMA Config. No.
<b>Connectors IP20 Suitability</b>				
<b>L1420C</b>	20 125/250	Black Back, White Front Body	.225"-1.150"	L14-20R
<b>L1520C</b>	20 3ø, 250	Black Back, White Front Body	.225"-1.150"	L15-20R
<b>L1620C</b>	20 3ø, 480	Black Back, White Front Body	.225"-1.150"	L16-20R
<b>L1820C</b>	20 3øY, 120/208	Black Back, White Front Body	.225"-1.150"	L18-20R
<b>L1430C</b>	30 125/250	Black Back, White Front Body	.225"-1.150"	L14-30R
<b>L1530C</b>	30 3ø, 250	Black Back, Black Front Body	.225"-1.150"	L15-30R
<b>L1630C</b>	30 3ø, 480	Black Back, Black Front Body	.225"-1.150"	L16-30R
<b>L1830C</b>	30 3øY, 120/208	Black Back, White Front Body	.225"-1.150"	L18-30R
<b>Plugs IP20 Suitability</b>				
<b>L1420P</b>	20 125/250	Black Back, White Front Body	.225"-1.150"	L14-20P
<b>L1520P</b>	20 3ø, 250	Black Back, White Front Body	.225"-1.150"	L15-20P
<b>L1620P</b>	20 3ø, 480	Black Back, White Front Body	.225"-1.150"	L16-20P
<b>L1820P</b>	20 3øY, 120/208	Black Back, White Front Body	.225"-1.150"	L18-20P
<b>L1430P</b>	30 125/250	Black Back, White Front Body	.225"-1.150"	L14-30P
<b>L1530P</b>	30 3ø, 250	Black Back, White Front Body	.225"-1.150"	L15-30P
<b>L1630P</b>	30 3ø, 480	Black Back, White Front Body	.225"-1.150"	L16-30P
<b>L1830P</b>	30 3øY, 120/208	Black Back, White Front Body	.225"-1.150"	L18-30P

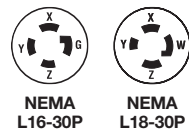
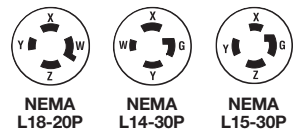
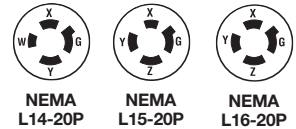
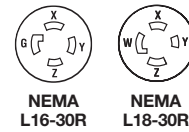
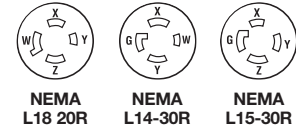
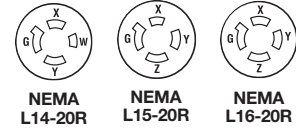

Download this product's PEP ecopassport® environmental product declaration at [www.legrand.us/resources-and-downloads](http://www.legrand.us/resources-and-downloads). This declaration conforms with ISO 14025 and 14040 and is in alignment with EN 15804.

For more information on these and other P&S products refer to our Catalog or visit our web site.

## Turnlok® Extra-Hard Use Plugs & Connectors 4 Wire 20 & 30A; 125 & 250V, 3Ø 250 & 480V, 3ØY 120/208V

### TECHNICAL SPECIFICATIONS

#### 3rd Party Compliance

UL Listed, File Number E146159, Standard UL498, Attachment Plugs and Receptacles. Federal Specification WC596.  
CSA Certified, File Number LR1765, Standard CSA-C22.2 No. 42, General Use Receptacles and Attachment Plugs.  
Conforms to NEMA WD-1 and WD-6.

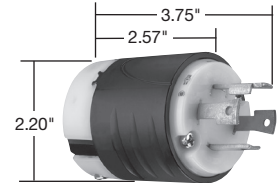

**Dimensions for  
20 & 30 Amp Plug**

#### Performance

##### Electrical

Dielectric Withstand Voltage	2200V minimum
Maximum Working Voltage	600VAC
Current Interrupting	Certified for current interrupting at full-rated current
Temperature Rise	30°C maximum after 50 cycles at 150% rated current

##### Mechanical

Cord Accommodations	Round portable service cords of diameters in accordance with the device rating as defined in UL62
Cord Grip Accommodations	.225"-1.150" diameter
Terminal Identification	"GR" and Green color = Ground, "WH" and White color = Neutral, "X", "Y", "Z" = Hot
Terminal Accommodation	#18 AWG min. – #8 AWG max.
Product Identification	Amperage, Voltage, 3rd Party Compliance, NEMA Configuration hot stamped onto device

##### Environmental

Flammability	UL94 V2
Operating Temperature	Maximum continuous +75°C, minimum -40°C without impact



**Dimensions for  
20 & 30 Amp Connector**

#### Materials

Back Body	Super Tough Nylon
Front Body	Nylon
Terminal Chamber	Polycarbonate
Cord Clamp	Nylon
Insert	Nylon
Dust Cover	Kraton
Plug Blades	Brass
Connector Contacts	Brass
Terminal Clamp	20A = Nickel-Plated Steel 30A = Brass
Terminal Screws	Brass
Ground Screws	Brass
Cord Clamp Screws	Nickel-Plated Steel
Assembly Screws	Nickel-Plated Steel

#### Warranty

1 Year

## NOTES

### ALSO AVAILABLE...

- USB Charging Devices
- Hospital Grade Devices
- PlugTail™ Devices
- Switches
- Straight Blade Receptacles
- Lighting & Fan Controls
- GFCIs
- Weatherproof Boxes & Covers
- Wall Plates
- Flexcor® Wire Mesh Grips



#### Electrical Wiring Systems

P.O. Box 4822  
Syracuse, NY 13221-4822  
Phone: 1.800.776.4035  
[www.legrand.us/passandseymour](http://www.legrand.us/passandseymour)  
570 Applewood Crescent  
Vaughan, Ontario L4K 4B4  
Phone: 905.738.9195  
[www.legrand.ca](http://www.legrand.ca)



**L1420, L1520, L1620, L1820, L1430, L1530, L1630, L1830**
**Tough enough for industrial environments.**

Every component of these durable Turnlok locking plugs and connectors are built to offer the lowest installed cost with maximum durability. Quick-thread assembly screws install four times faster than competitive product and backed-out screws come ready-to-wire. The rugged easy-to-grip nylon housing, clear thermoplastic terminal chambers as well as high-strength brass alloy blades and contacts combine to give Legrand the premium selection of P&S Turnlok plugs and connectors.

**FEATURES & BENEFITS**

**Rounded back contour** reduces snags and hang-ups on the job site.

**Visible stamped NEMA configuration and device rating.**

**Raised ribs** provide non-slip gripping profile for turning to lock and unlock.

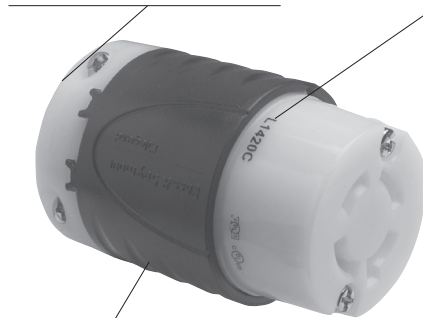

**Industrial-strength, brass alloy plug blades** and connector contacts resist heat rise, provide excellent conductivity.

**Double dovetail design** provides superior protection against cord pull-out forces.



**Scallop shell design** provides non-slip gripping surface for insertion and withdrawal.

**Impact- and corrosion-resistant** durable nylon 6/6 shell material.

**L1420C & L1420P**

**Quick-thread assembly screws** and cord-grip screws come backed-out, ready-to-wire. Installs four times faster.

**External cord grips** provide visible assurance of safe and proper cord retention.

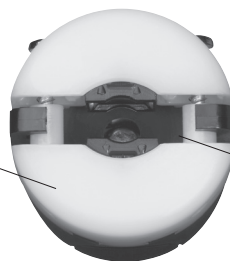

**Integral flexible rubber cord grommet** conforms to and seals around SO cord to provide protection from oils, water, or chips entering wiring chamber.

**FIELD USES/VERTICAL MARKETS**

- Industrial
- Health Care
- Education
- Institutional
- Retail
- Office
- Hospitality/Lodging

### ORDERING INFORMATION

Catalog Number	Rating A. V.	Description/Color	Cord Diameter	NEMA Config. No.
<b>Connectors IP20 Suitability</b>				
<b>L1420C</b>	20 125/250	Black Back, White Front Body	.225"-1.150"	L14-20R
<b>L1520C</b>	20 3ø, 250	Black Back, White Front Body	.225"-1.150"	L15-20R
<b>L1620C</b>	20 3ø, 480	Black Back, White Front Body	.225"-1.150"	L16-20R
<b>L1820C</b>	20 3øY, 120/208	Black Back, White Front Body	.225"-1.150"	L18-20R
<b>L1430C</b>	30 125/250	Black Back, White Front Body	.225"-1.150"	L14-30R
<b>L1530C</b>	30 3ø, 250	Black Back, Black Front Body	.225"-1.150"	L15-30R
<b>L1630C</b>	30 3ø, 480	Black Back, Black Front Body	.225"-1.150"	L16-30R
<b>L1830C</b>	30 3øY, 120/208	Black Back, White Front Body	.225"-1.150"	L18-30R
<b>Plugs IP20 Suitability</b>				
<b>L1420P</b>	20 125/250	Black Back, White Front Body	.225"-1.150"	L14-20P
<b>L1520P</b>	20 3ø, 250	Black Back, White Front Body	.225"-1.150"	L15-20P
<b>L1620P</b>	20 3ø, 480	Black Back, White Front Body	.225"-1.150"	L16-20P
<b>L1820P</b>	20 3øY, 120/208	Black Back, White Front Body	.225"-1.150"	L18-20P
<b>L1430P</b>	30 125/250	Black Back, White Front Body	.225"-1.150"	L14-30P
<b>L1530P</b>	30 3ø, 250	Black Back, White Front Body	.225"-1.150"	L15-30P
<b>L1630P</b>	30 3ø, 480	Black Back, White Front Body	.225"-1.150"	L16-30P
<b>L1830P</b>	30 3øY, 120/208	Black Back, White Front Body	.225"-1.150"	L18-30P

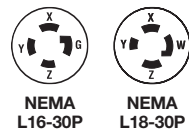
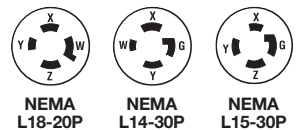
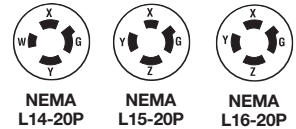
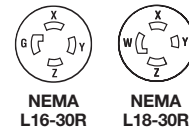
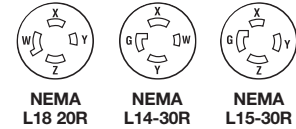
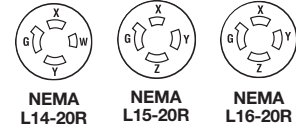

Download this product's PEP ecopassport® environmental product declaration at [www.legrand.us/resources-and-downloads](http://www.legrand.us/resources-and-downloads). This declaration conforms with ISO 14025 and 14040 and is in alignment with EN 15804.

For more information on these and other P&S products refer to our Catalog or visit our web site.

## Turnlok® Extra-Hard Use Plugs & Connectors 4 Wire 20 & 30A; 125 & 250V, 3Ø 250 & 480V, 3ØY 120/208V

### TECHNICAL SPECIFICATIONS

#### 3rd Party Compliance

UL Listed, File Number E146159, Standard UL498, Attachment Plugs and Receptacles. Federal Specification WC596.  
 CSA Certified, File Number LR1765, Standard CSA-C22.2 No. 42, General Use Receptacles and Attachment Plugs.  
 Conforms to NEMA WD-1 and WD-6.

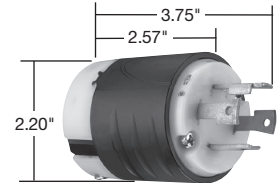

**Dimensions for  
20 & 30 Amp Plug**

#### Performance

##### Electrical

Dielectric Withstand Voltage	2200V minimum
Maximum Working Voltage	600VAC
Current Interrupting	Certified for current interrupting at full-rated current
Temperature Rise	30°C maximum after 50 cycles at 150% rated current

##### Mechanical

Cord Accommodations	Round portable service cords of diameters in accordance with the device rating as defined in UL62
Cord Grip Accommodations	.225"-1.150" diameter
Terminal Identification	"GR" and Green color = Ground, "WH" and White color = Neutral, "X", "Y", "Z" = Hot
Terminal Accommodation	#18 AWG min. – #8 AWG max.
Product Identification	Amperage, Voltage, 3rd Party Compliance, NEMA Configuration hot stamped onto device

##### Environmental

Flammability	UL94 V2
Operating Temperature	Maximum continuous +75°C, minimum -40°C without impact



**Dimensions for  
20 & 30 Amp Connector**

#### Materials

Back Body	Super Tough Nylon
Front Body	Nylon
Terminal Chamber	Polycarbonate
Cord Clamp	Nylon
Insert	Nylon
Dust Cover	Kraton
Plug Blades	Brass
Connector Contacts	Brass
Terminal Clamp	20A = Nickel-Plated Steel 30A = Brass
Terminal Screws	Brass
Ground Screws	Brass
Cord Clamp Screws	Nickel-Plated Steel
Assembly Screws	Nickel-Plated Steel

#### Warranty

1 Year

## NOTES

### ALSO AVAILABLE...

- USB Charging Devices
- Hospital Grade Devices
- PlugTail™ Devices
- Switches
- Straight Blade Receptacles
- Lighting & Fan Controls
- GFCIs
- Weatherproof Boxes & Covers
- Wall Plates
- Flexcor® Wire Mesh Grips



#### Electrical Wiring Systems

P.O. Box 4822  
Syracuse, NY 13221-4822  
Phone: 1.800.776.4035  
[www.legrand.us/passandseymour](http://www.legrand.us/passandseymour)  
570 Applewood Crescent  
Vaughan, Ontario L4K 4B4  
Phone: 905.738.9195  
[www.legrand.ca](http://www.legrand.ca)

