



KT-LED45HID-EX39-850-D

HID REPLACEMENT LED LAMP

rev.1

DESCRIPTION

45W HID Replacement LED Lamp | 5000K | >83 CRI | IP64 Rated



LAMP TYPE: HID Replacement LED
BASE TYPE: EX39 (Mogul)
WATTAGE: 45W
COLOR TEMPERATURE: 5000K
METAL HALIDE EQUIVALENT: 175W
COLOR RENDERING INDEX (CRI): >83
WARRANTY: 5 Years



PRODUCT FEATURES

- Replacement for Conventional Metal Halide Lamp
- Non-Dimmable; Do Not Dim
- 50,000+ Hour Lifetime
- Environmentally Friendly: No Mercury Used
- Instant Startup
- UL Listed
- DLC Listed
- Operating Temperature: -29°C/-20°F to 60°C/140°F
- Integral Driver, Eliminates the Need for External Driver or Ballast; Includes 4kV Surge Protection
- IP64 Rated; Integrated Heat Sink Quickly Dissipates Heat and Guides Water Intrusion Out of the Lamp
- Suitable for Use in Fully Enclosed Fixture

OPERATING SPECIFICATIONS

ELECTRICAL CHARACTERISTICS

Input Voltage	Power Consumption	Power Factor	Input Current
120-277Vac	45W	>0.9	0.42A @ 120V 0.18A @ 277V

RATED LIFE

L70 (Hours)	50,000
-------------	--------

PHOTOMETRIC CHARACTERISTICS

Color Temperature (CCT)	5000K
Luminous Flux	6350 lm
Color Rendering Index (CRI)	>83
Efficacy	141 lm/W
Visible Light Area	360°

SPECTRAL DISTRIBUTION

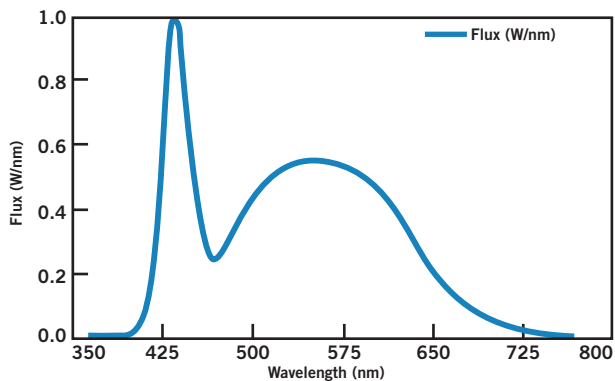

LUX DISTANCE CURVE

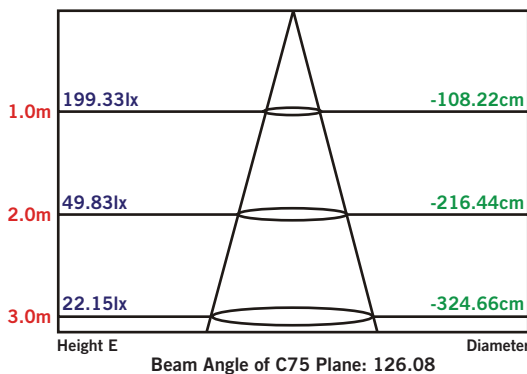



KT-LED45HID-EX39-850-D

HID REPLACEMENT LED LAMP

rev.1



E39 MOGUL SOCKET



EX39 MOGUL SOCKET

EX39-based lamps will work in both E39 and EX39 sockets.

WIRING DIAGRAM

STEP 1

Disconnect power. Disconnect and remove existing ballast, capacitor, and/or ignitor (where applicable) from fixture.

STEP 2

Rewire for line voltage to the lamp socket.

STEP 3

Install new LED replacement lamp. Ensure lamp is operating properly when power is turned on.



FIGURE 1

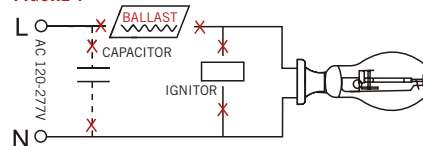

FIGURE 2

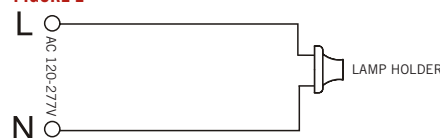
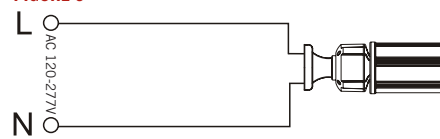
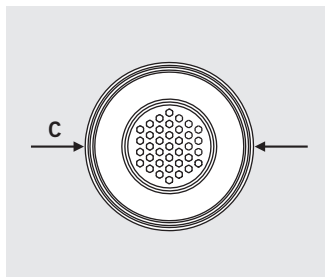
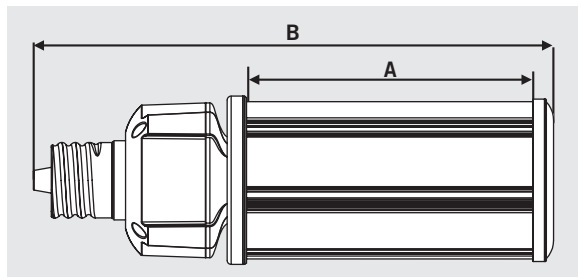

FIGURE 3



PHYSICAL CHARACTERISTICS



LAMP DIMENSIONS

A (Illuminated Length)	5.83"
B (Body Length)	10.70"
C (Diameter)	3.43"

BASE TYPE: EX39 (Mogul)

ORDERING INFORMATION

ORDER CODE	PACKAGING STYLE	PACK QTY.	ITEM STATUS
KT-LED45HID-EX39-850-D rev1	Distributor Pack (Individual Cartons)	16	Quick Ship

CATALOG NUMBER BREAKDOWN

KT-LED45HID-EX39-850-D rev1

Keystone Technologies | LED Lamp | Wattage | Lamp Type | Base Type | 800 Series | Color Temp. | Direct Drive Series | LED Chip Revision



KT-LED45HID-EX39-850-D

HID REPLACEMENT LED LAMP

rev.1

DESCRIPTION

45W HID Replacement LED Lamp | 5000K | >83 CRI | IP64 Rated



LAMP TYPE: HID Replacement LED
BASE TYPE: EX39 (Mogul)
WATTAGE: 45W
COLOR TEMPERATURE: 5000K
METAL HALIDE EQUIVALENT: 175W
COLOR RENDERING INDEX (CRI): >83
WARRANTY: 5 Years



PRODUCT FEATURES

- Replacement for Conventional Metal Halide Lamp
- Non-Dimmable; Do Not Dim
- 50,000+ Hour Lifetime
- Environmentally Friendly: No Mercury Used
- Instant Startup
- UL Listed
- DLC Listed
- Operating Temperature: -29°C/-20°F to 60°C/140°F
- Integral Driver, Eliminates the Need for External Driver or Ballast; Includes 4kV Surge Protection
- IP64 Rated; Integrated Heat Sink Quickly Dissipates Heat and Guides Water Intrusion Out of the Lamp
- Suitable for Use in Fully Enclosed Fixture

OPERATING SPECIFICATIONS

ELECTRICAL CHARACTERISTICS

Input Voltage	Power Consumption	Power Factor	Input Current
120-277Vac	45W	>0.9	0.42A @ 120V 0.18A @ 277V

RATED LIFE

L70 (Hours)	50,000
-------------	--------

PHOTOMETRIC CHARACTERISTICS

Color Temperature (CCT)	5000K
Luminous Flux	6350 lm
Color Rendering Index (CRI)	>83
Efficacy	141 lm/W
Visible Light Area	360°

SPECTRAL DISTRIBUTION

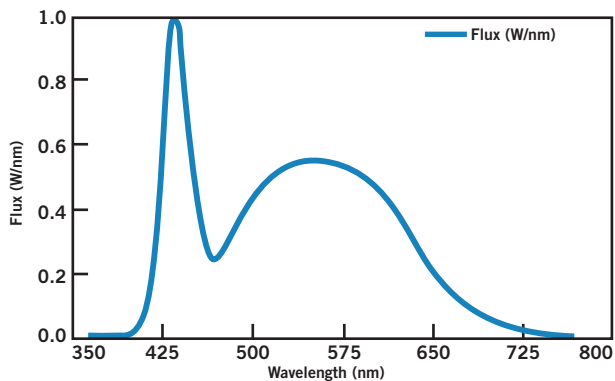

LUX DISTANCE CURVE

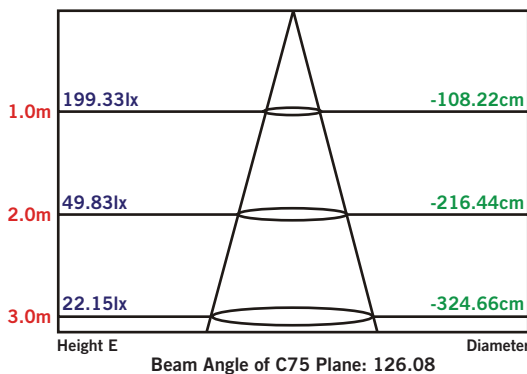



KT-LED45HID-EX39-850-D

HID REPLACEMENT LED LAMP

rev.1

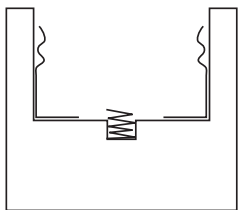

E39 MOGUL SOCKET

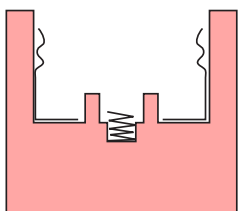

EX39 MOGUL SOCKET

EX39-based lamps will work in both E39 and EX39 sockets.

WIRING DIAGRAM

STEP 1

Disconnect power. Disconnect and remove existing ballast, capacitor, and/or ignitor (where applicable) from fixture.

STEP 2

Rewire for line voltage to the lamp socket.

STEP 3

Install new LED replacement lamp. Ensure lamp is operating properly when power is turned on.

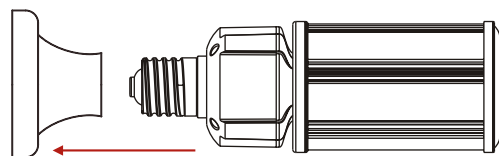

FIGURE 1

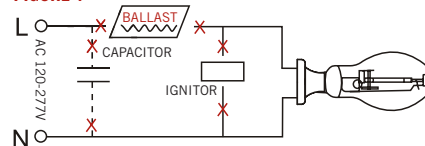

FIGURE 2

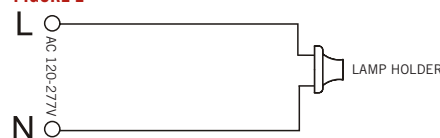
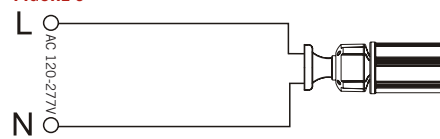
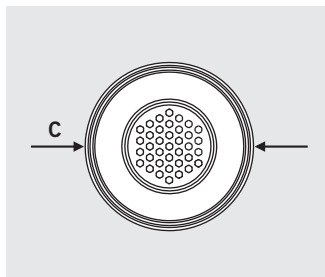
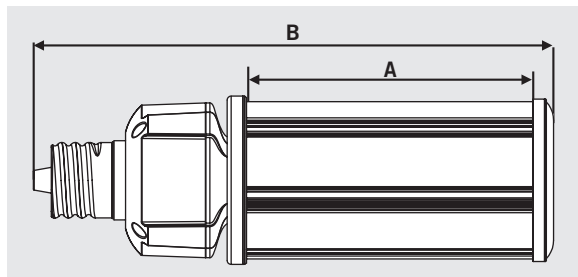

FIGURE 3



PHYSICAL CHARACTERISTICS



LAMP DIMENSIONS

A (Illuminated Length)	5.83"
B (Body Length)	10.70"
C (Diameter)	3.43"

BASE TYPE: EX39 (Mogul)

ORDERING INFORMATION

ORDER CODE	PACKAGING STYLE	PACK QTY.	ITEM STATUS
KT-LED45HID-EX39-850-D rev1	Distributor Pack (Individual Cartons)	16	Quick Ship

CATALOG NUMBER BREAKDOWN

KT-LED45HID-EX39-850-D rev1

Keystone Technologies | LED Lamp | Wattage | Lamp Type | Base Type | 800 Series | Color Temp. | Direct Drive Series | LED Chip Revision