

FM7™ Unilet® Conduit Outlet Bodies

For use with Rigid Steel, Rigid Aluminum and IMC Conduit.

Applications

- Serve as pulling fittings.
- Make bends in conduit system.
- Provide openings for splicing.
- Connect and change direction of conduit runs.
- Allow connections for branch runs.
- Permit access to conductors for maintenance.

Features

- Smooth, rounded integral bushings in hubs protect conductor insulation.
- Accurately tapped, tapered threads for tight, rigid joints and excellent ground continuity.
- Wedge-Lok™ Form-IN-Place covers with integral gasket are approved for use in wet locations. Grayloy-iron bodies with cast covers and gasket are approved for use in wet locations.
- Unique Wedge-Lok™ clip cover design allows easy removal at any later time, without damaging the conduit body. The cover is secured with clips, not screws.
- Completely interchangeable with Crouse-Hinds⁺ Form 7™⁺ bodies, gaskets and covers. Equivalent FM7 and Form 7™ units have identical applications and installation dimensions.
- Flat back design provides greater cubic content for easier wire pulling, and more room for splicing. Fits flush and snug against flat surfaces for more stable installation.
- Smooth hub bushings and cover openings protect conductor insulation. Smooth hub openings allow easy conduit joining.
- Pan-head cover screws secure cover clips and provide superior screwdriver seating and torque. Cover screws and clips are captive to prevent loss.
- Hub size, body style, compliance data, maximum wire number/size and cubic capacity molded into body.

Standard Materials

- Body: Grayloy-iron or copperfree (4/10 of 1% max.) aluminum
- Covers: Grayloy-iron, copperfree (4/10 of 1% max.) aluminum or steel
- Cover screws: stainless steel

Standard Finishes

- Grayloy-iron bodies and covers: triplecoat — (1) zinc electroplate, (2) chromate, and (3) epoxy powder coat
- Cast aluminum bodies and covers: epoxy powder coat
- Steel covers: zinc electroplate
- Stamped aluminum covers: natural finish

Certifications and Compliances

- UL Standard: 514A , 514B
- UL Listed: E2527
- CSA Standard: C22.2 No. 18.3
- CSA Certified: 065183
- NEMA Standard: FB-1

Options

- PVC coating available on select aluminum bodies and covers. Add suffix **-PVC** to catalog number.



Type LB

Illustrated Features



Conduit Body with Cast Aluminum Cover, 1" Type C shown



Grayloy™-Iron, 1" Type C shown with cut-away body and cover to illustrate Wedge-Lok™ Clip Cover detail

Illustrated views are cut away to demonstrate back configurations.



Appleton FM7 (C57, 1-1/2")
28 Cubic Inches Capacity
Flat-Back Design



Crouse-Hinds Form 7 (C57, 1-1/2")
26 Cubic Inches Capacity

+ Crouse-Hinds and Form 7 are registered trademarks of Cooper Crouse-Hinds.

FM7™ Unilet® Conduit Bodies

For use with Rigid Steel, Rigid Aluminum and IMC Conduit.

Fittings

FITTINGS: CONDUIT BODIES

Appleton FM7 Conduit Bodies *

| Hub Size (inches) | C | | LB | | LL | | LR | | T | |
|----------------------|---|------------|---|------------|---|------------|--|------------|---|------------|
| | Grayloy-Iron | Aluminum ‡ | Grayloy-Iron | Aluminum ‡ | Grayloy-Iron | Aluminum ‡ | Grayloy-Iron | Aluminum ‡ | Grayloy-Iron | Aluminum ‡ |
| |  | |  | |  | |  | |  | |
| 1/2 | C17 | C17-SA | LB17 | LB17-SA | LL17 | LL17-SA | LR17 | LR17-SA | T17 | T17-SA |
| 3/4 | C27 | C27-SA | LB27 | LB27-SA | LL27 | LL27-SA | LR27 | LR27-SA | T27 | T27-SA |
| 1 | C37 | C37-SA | LB37 | LB37-SA | LL37 | LL37-SA | LR37 | LR37-SA | T37 | T37-SA |
| 1-1/4 | C47 | C47-SA | LB47 | LB47-SA | LL47 | LL47-SA | LR47 | LR47-SA | T47 | T47-SA |
| 1-1/2 | C57 | C57-SA | LB57 | LB57-SA | LL57 | LL57-SA | LR57 | LR57-SA | T57 | T57-SA |
| 2 | C67 | C67-SA | LB67 | LB67-SA | LL67 | LL67-SA | LR67 | LR67-SA | T67 | T67-SA |
| 2-1/2 | C77 | C77-SA | LB77 | LB77-SA | LL77 | LL77-SA | LR77 | LR77-SA | T77 | T77-SA |
| 3 | C87 | C87-SA | LB87 | LB87-SA | LL87 | LL87-SA | LR87 | LR87-SA | T87 | T87-SA |
| 3-1/2 | — | — | LB97 | LB97-SA | LL97 | LL97-SA | LR97 | LR97-SA | T97 | T97-SA |
| 4 | — | — | LB107 | LB107-SA | LL107 | LL107-SA | LR107 | LR107-SA | T107 | T107-SA |

| Hub Size (inches) | E | | L † | | TA | | TB | | X | |
|----------------------|---|----------|---|----------|---|----------|--|------------|---|------------|
| | Grayloy-Iron | Aluminum | Grayloy-Iron | Aluminum | Grayloy-Iron | Aluminum | Grayloy-Iron | Aluminum ‡ | Grayloy-Iron | Aluminum ‡ |
| |  | |  | |  | |  | |  | |
| 1/2 | E17 | E17-SA | L17 | — | TA17 | — | TB17 | TB17-SA | X17 | X17-SA |
| 3/4 | E27 | E27-SA | L27 | — | TA27 | — | TB27 | TB27-SA | X27 | X27-SA |
| 1 | E37 | E37-SA | L37 | — | TA37 | — | TB37 | TB37-SA | X37 | X37-SA |
| 1-1/4 | — | — | L47 | — | TA47 | — | TB47 | TB47-SA | X47 | X47-SA |
| 1-1/2 | — | — | L57 | — | TA57 | — | TB57 | TB57-SA | X57 | X57-SA |
| 2 | — | — | L67 | — | TA67 | — | TB67 | TB67-SA | X67 | X67-SA |

* Refer to following pages for Wiring Capacity Table.

† L Unilets have double opening and are furnished with one steel cover, assembled.

‡ PVC coating available on select aluminum bodies. Add suffix **-PVC** to catalog number.

FM7™ Unilet® Conduit Outlet Bodies and Covers Wiring Capacity

For use with Rigid Steel, Rigid Aluminum and IMC Conduit.

Fittings
FITTINGS: CONDUIT BODIES

Wiring Capacity: Combine Body and Cover Capacities for Total Usable Capacity per NEC 314.16(A)

| Hub Size (Inches) | Capacity (in ³ /dm ³) | | | | | | | | | Stamped Cover | Cast Cover | |
|---|--|----------------|-----------------|-----------------|----------------|-----------------|----------------|----------------|----------------|----------------|----------------|----------------|
| | C | E | LB | LL LR | L | T | TA | TB | X | | | |
| FM7™ Grayloy™-Iron Bodies and Covers: Threaded | | | | | | | | | | | | |
| 1/2 | 4.00/ 0.07 | 4.00/ 0.07 | 4.00/ 0.07 | 4.00/ 0.07 | 5.00/ 0.08 | 6.00/ 0.10 | 6.00/ 0.10 | 6.00/ 0.10 | 6.00/ 0.10 | 6.00/ 0.10 | 0.30/ 0.00 | 0.40/ 0.01 |
| 3/4 | 7.00/ 0.11 | 7.00/ 0.11 | 7.00/ 0.11 | 7.00/ 0.11 | 9.00/ 0.15 | 10.00/ 0.16 | 10.00/ 0.16 | 10.00/ 0.16 | 10.00/ 0.16 | 10.00/ 0.16 | 0.50/ 0.01 | 0.80/ 0.01 |
| 1 | 11.00/ 0.18 | 11.00/ 0.18 | 11.00/ 0.18 | 11.00/ 0.18 | 13.50/ 0.22 | 15.50/ 0.25 | 15.50/ 0.25 | 15.50/ 0.25 | 15.50/ 0.25 | 15.50/ 0.25 | 1.30/ 0.02 | 1.30/ 0.02 |
| 1-1/4 | 20.00/ 0.33 | — | 20.00/ 0.33 | 20.00/ 0.33 | 22.50/ 0.37 | 20.00/ 0.33 | 20.00/ 0.33 | 20.00/ 0.33 | 20.00/ 0.33 | 20.00/ 0.33 | 1.80/ 0.03 | 2.00/ 0.03 |
| 1-1/2 | 28.00/ 0.46 | — | 28.00/ 0.46 | 28.00/ 0.46 | 31.00/ 0.51 | 28.00/ 0.46 | 28.00/ 0.46 | 28.00/ 0.46 | 28.00/ 0.46 | 28.00/ 0.46 | 2.30/ 0.04 | 3.00/ 0.05 |
| 2 | 50.00/ 0.82 | — | 50.00/ 0.82 | 50.00/ 0.82 | 50.00/ 0.82 | 50.00/ 0.82 | 50.00/ 0.82 | 50.00/ 0.82 | 50.00/ 0.82 | 50.00/ 0.82 | 2.80/ 0.05 | 4.80/ 0.08 |
| 2-1/2 | 102.00/ 1.67 | — | 102.00/ 1.67 | 102.00/ 1.67 | — | 102.00/ 1.67 | — | — | — | — | 9.80/ 0.16 | 9.70/ 0.16 |
| 3 | 133.00/ 2.18 | — | 133.00/ 2.18 | 133.00/ 2.18 | — | 133.00/ 2.18 | — | — | — | — | 9.80/ 0.16 | 9.70/ 0.16 |
| 3-1/2 | — | — | 218.00/ 3.57 | 218.00/ 3.57 | — | 218.00/ 3.57 | — | — | — | — | 16.50/ 0.27 | 16.00/ 0.26 |
| 4 | — | — | 244.00/ 4.00 | 244.00/ 4.00 | — | 244.00/ 4.00 | — | — | — | — | 16.50/ 0.27 | 16.00/ 0.26 |
| FM7™ Aluminum Bodies and Covers: Threaded | | | | | | | | | | | | |
| 1/2 | 4.00/ 0.07 | 4.00/ 0.07 | 4.00/ 0.07 | 4.00/ 0.07 | — | 6.00/ 0.10 | — | 6.00/ 0.10 | 6.00/ 0.10 | 6.00/ 0.10 | 0.30/ 0.005 | 0.40/ 0.007 |
| 3/4 | 7.00/ 0.11 | 7.00/ 0.11 | 7.00/ 0.11 | 7.00/ 0.11 | — | 10.00/ 0.16 | — | 10.00/ 0.16 | 10.00/ 0.16 | 10.00/ 0.16 | 0.50/ 0.008 | 0.80/ 0.01 |
| 1 | 11.00/ 0.18 | 11.00/ 0.18 | 11.00/ 0.18 | 11.00/ 0.18 | — | 15.50/ 0.25 | — | 15.50/ 0.25 | 15.50/ 0.25 | 15.50/ 0.25 | 1.30/ 0.02 | 1.30/ 0.02 |
| 1-1/4 | 20.00/ 0.33 | — | 20.00/ 0.33 | 20.00/ 0.33 | — | 20.00/ 0.33 | — | 20.00/ 0.33 | 20.00/ 0.33 | 20.00/ 0.33 | 1.80/ 0.03 | 2.00/ 0.03 |
| 1-1/2 | 28.00/ 0.46 | — | 28.00/ 0.46 | 28.00/ 0.46 | — | 28.00/ 0.46 | — | 28.00/ 0.46 | 28.00/ 0.46 | 28.00/ 0.46 | 2.30/ 0.04 | 3.00/ 0.05 |
| 2 | 50.00/ 0.82 | — | 50.00/ 0.82 | 50.00/ 0.82 | — | 50.00/ 0.82 | — | 50.00/ 0.82 | 50.00/ 0.82 | 50.00/ 0.82 | 2.80/ 0.05 | 4.80/ 0.08 |
| 2-1/2 | 102.00/ 1.67 | — | 102.00/ 1.67 | 102.00/ 1.67 | — | 102.00/ 1.67 | — | — | — | — | 9.80/ 0.16 | 9.70/ 0.16 |
| 3 | 133.00/ 2.18 | — | 133.00/ 2.18 | 133.00/ 2.18 | — | 133.00/ 2.18 | — | — | — | — | 9.80/ 0.16 | 9.70/ 0.16 |
| 3-1/2 | — | — | 218.00/ 3.57 | 218.00/ 3.57 | — | 218.00/ 3.57 | — | — | — | — | 16.50/ 0.27 | 16.00/ 0.26 |
| 4 | — | — | 244.00/ 4.00 | 244.00/ 4.00 | — | 244.00/ 4.00 | — | — | — | — | 16.50/ 0.27 | 16.00/ 0.26 |

FM7™ Unilet® Conduit Outlet Body Dimensions

For use with Rigid Steel, Rigid Aluminum and IMC Conduit.

Fittings

FITTINGS: CONDUIT BODIES

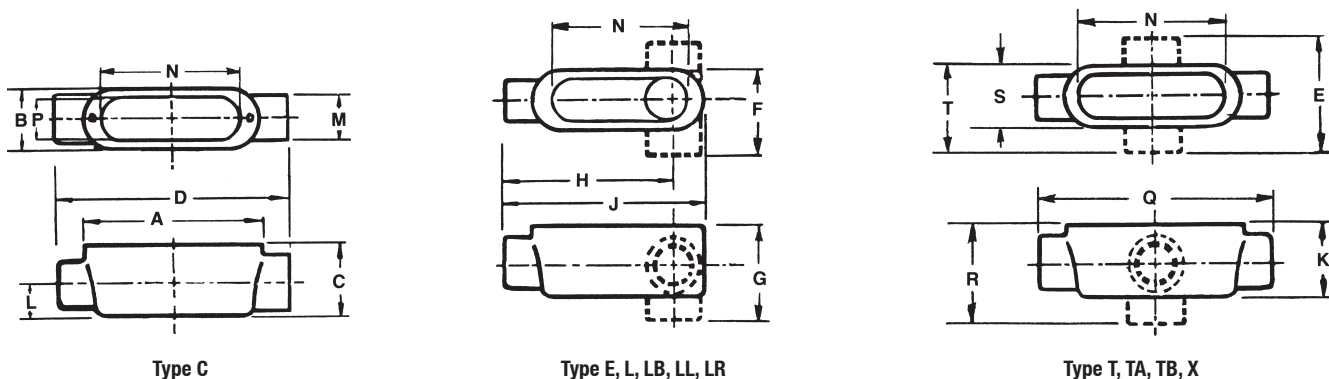

| Hub Size (Inches) | Dimensions in Inches/Millimeters | | | | | | | | | | | | | | | | | | |
|-------------------|----------------------------------|-------------|-------------|--------------|-------------|-------------|-------------|--------------|--------------|-------------|------------|-------------|--------------|-------------|--------------|-------------|-------------|-------------|--|
| | A | B | C | D | E | F | G | H | J | K | L | M | N | P | Q | R | S | T | |
| 1/2 | 3.63/ 92.2 | 1.38/ 35.1 | 1.38/ 35.1 | 5.38/ 136.7 | 3.31/ 84.1 | 2.25/ 57.2 | 2.25/ 57.2 | 3.94/ 100.1 | 4.56/ 115.8 | 1.75/ 44.5 | 0.63/ 16.0 | 1.25/ 31.8 | 3.19/ 81.0 | 0.94/ 23.9 | 5.63/ 143.0 | 2.63/ 66.8 | 1.56/ 39.6 | 2.44/ 62.0 | |
| 3/4 | 4.25/ 108.0 | 1.56/ 39.6 | 1.63/ 41.4 | 6.00/ 152.4 | 3.50/ 88.9 | 2.44/ 62.0 | 2.50/ 63.5 | 4.44/ 112.8 | 5.19/ 131.8 | 2.00/ 50.8 | 0.75/ 19.1 | 1.50/ 38.1 | 3.81/ 96.8 | 1.13/ 28.7 | 6.25/ 158.8 | 2.88/ 73.2 | 1.88/ 47.8 | 2.63/ 66.8 | |
| 1 | 5.00/ 127.0 | 1.75/ 44.5 | 1.88/ 47.8 | 7.00/ 177.8 | 3.88/ 98.6 | 2.75/ 69.9 | 2.88/ 73.2 | 5.19/ 131.8 | 6.00/ 152.4 | 2.25/ 57.2 | 0.88/ 22.4 | 1.75/ 44.5 | 4.50/ 114.3 | 1.38/ 35.1 | 7.25/ 184.2 | 3.25/ 82.6 | 2.00/ 50.8 | 3.00/ 76.2 | |
| 1-1/4 | 5.50/ 139.7 | 2.19/ 55.6 | 2.31/ 58.7 | 7.44/ 189.0 | 4.13/ 104.9 | 3.19/ 81.0 | 3.31/ 84.1 | 5.44/ 138.2 | 6.50/ 165.1 | 2.31/ 58.7 | 1.13/ 28.7 | 2.19/ 55.6 | 5.00/ 127.0 | 1.75/ 44.5 | 7.44/ 189.0 | 3.31/ 84.1 | 2.19/ 55.6 | 3.19/ 81.0 | |
| 1-1/2 | 6.00/ 152.4 | 2.44/ 62.0 | 2.56/ 65.0 | 8.19/ 208.0 | 4.63/ 117.6 | 3.50/ 88.9 | 3.69/ 93.7 | 5.94/ 150.9 | 7.13/ 181.1 | 2.56/ 65.0 | 1.25/ 31.8 | 2.44/ 62.0 | 5.44/ 138.2 | 1.94/ 49.3 | 8.19/ 208.0 | 3.63/ 92.2 | 2.44/ 62.0 | 3.56/ 90.4 | |
| 2 | 7.00/ 177.8 | 3.00/ 76.2 | 3.13/ 79.5 | 9.19/ 233.4 | 5.19/ 131.8 | 4.06/ 103.1 | 4.25/ 108.0 | 6.63/ 168.4 | 8.13/ 206.5 | 3.13/ 79.5 | 1.50/ 38.1 | 3.00/ 76.2 | 6.38/ 162.1 | 2.44/ 62.0 | 9.19/ 233.4 | 4.19/ 106.4 | 3.00/ 76.2 | 4.13/ 104.9 | |
| 2-1/2 | 9.00/ 228.6 | 4.25/ 108.0 | 3.63/ 92.2 | 12.00/ 304.8 | — | 5.75/ 146.1 | 5.13/ 130.3 | 8.75/ 222.3 | 10.50/ 266.7 | 3.63/ 92.2 | 1.75/ 44.5 | 3.50/ 88.9 | 8.38/ 212.9 | 3.56/ 90.4 | 12.00/ 304.8 | — | 4.25/ 108.0 | 5.75/ 146.1 | |
| 3 | 9.00/ 228.6 | 4.25/ 108.0 | 4.38/ 111.3 | 12.00/ 304.8 | — | 5.75/ 146.1 | 5.88/ 149.4 | 8.38/ 212.9 | 10.50/ 266.7 | 4.38/ 111.3 | 2.13/ 54.1 | 4.25/ 108.0 | 8.38/ 212.9 | 3.56/ 90.4 | 12.06/ 306.3 | — | 4.25/ 108.0 | 5.75/ 146.1 | |
| 3-1/2 | 11.00/ 279.4 | 5.25/ 133.4 | 4.88/ 124.0 | — | — | 6.94/ 176.3 | 6.56/ 166.6 | 10.25/ 260.4 | 12.69/ 322.3 | 4.88/ 124.0 | 2.38/ 60.5 | 4.75/ 120.7 | 10.25/ 260.4 | 4.50/ 114.3 | 14.31/ 363.5 | — | 5.25/ 133.4 | 6.94/ 176.3 | |
| 4 | 11.00/ 279.4 | 5.25/ 133.4 | 5.38/ 136.7 | — | — | 6.94/ 176.3 | 7.06/ 179.3 | 10.00/ 254.0 | 12.69/ 322.3 | 5.38/ 136.7 | 2.63/ 66.8 | 5.25/ 133.4 | 10.25/ 260.4 | 4.50/ 114.3 | 14.31/ 363.5 | — | 5.25/ 133.4 | 6.94/ 176.3 | |

Fraction/Decimal Equivalents (Inches)

| Fraction | Decimal | Fraction | Decimal | Fraction | Decimal | Fraction | Decimal |
|----------|---------|----------|---------|----------|---------|----------|---------|
| 1/16 | 0.06 | 5/16 | 0.31 | 9/16 | 0.56 | 13/16 | 0.81 |
| 1/8 | 0.13 | 3/8 | 0.38 | 5/8 | 0.63 | 7/8 | 0.88 |
| 3/16 | 0.19 | 7/16 | 0.44 | 11/16 | 0.69 | 15/16 | 0.94 |
| 1/4 | 0.25 | 1/2 | 0.50 | 3/4 | 0.75 | 1 | 1.00 |

FM7™ Unilet® Conduit Outlet Bodies

For use with Rigid Steel, Rigid Aluminum and IMC Conduit.

Applications

- Serve as pulling fittings.
- Make bends in conduit system.
- Provide openings for splicing.
- Connect and change direction of conduit runs.
- Allow connections for branch runs.
- Permit access to conductors for maintenance.

Features

- Smooth, rounded integral bushings in hubs protect conductor insulation.
- Accurately tapped, tapered threads for tight, rigid joints and excellent ground continuity.
- Wedge-Lok™ Form-IN-Place covers with integral gasket are approved for use in wet locations. Grayloy-iron bodies with cast covers and gasket are approved for use in wet locations.
- Unique Wedge-Lok™ clip cover design allows easy removal at any later time, without damaging the conduit body. The cover is secured with clips, not screws.
- Completely interchangeable with Crouse-Hinds⁺ Form 7™⁺ bodies, gaskets and covers. Equivalent FM7 and Form 7™ units have identical applications and installation dimensions.
- Flat back design provides greater cubic content for easier wire pulling, and more room for splicing. Fits flush and snug against flat surfaces for more stable installation.
- Smooth hub bushings and cover openings protect conductor insulation. Smooth hub openings allow easy conduit joining.
- Pan-head cover screws secure cover clips and provide superior screwdriver seating and torque. Cover screws and clips are captive to prevent loss.
- Hub size, body style, compliance data, maximum wire number/size and cubic capacity molded into body.

Standard Materials

- Body: Grayloy-iron or copperfree (4/10 of 1% max.) aluminum
- Covers: Grayloy-iron, copperfree (4/10 of 1% max.) aluminum or steel
- Cover screws: stainless steel

Standard Finishes

- Grayloy-iron bodies and covers: triplecoat — (1) zinc electroplate, (2) chromate, and (3) epoxy powder coat
- Cast aluminum bodies and covers: epoxy powder coat
- Steel covers: zinc electroplate
- Stamped aluminum covers: natural finish

Certifications and Compliances

- UL Standard: 514A , 514B
- UL Listed: E2527
- CSA Standard: C22.2 No. 18.3
- CSA Certified: 065183
- NEMA Standard: FB-1

Options

- PVC coating available on select aluminum bodies and covers. Add suffix **-PVC** to catalog number.



Type LB

Illustrated Features



Conduit Body with Cast Aluminum Cover, 1" Type C shown



Grayloy™-Iron, 1" Type C shown with cut-away body and cover to illustrate Wedge-Lok™ Clip Cover detail

Illustrated views are cut away to demonstrate back configurations.



Appleton FM7 (C57, 1-1/2")
28 Cubic Inches Capacity
Flat-Back Design



Crouse-Hinds Form 7 (C57, 1-1/2")
26 Cubic Inches Capacity





+ Crouse-Hinds and Form 7 are registered trademarks of Cooper Crouse-Hinds.





FM7™ Unilet® Conduit Bodies

For use with Rigid Steel, Rigid Aluminum and IMC Conduit.

Fittings
FITTINGS: CONDUIT BODIES

Appleton FM7 Conduit Bodies *

| Hub Size (inches) | C | | LB | | LL | | LR | | T | |
|----------------------|---|------------|---|------------|---|------------|--|------------|---|------------|
| | Grayloy-Iron | Aluminum ‡ | Grayloy-Iron | Aluminum ‡ | Grayloy-Iron | Aluminum ‡ | Grayloy-Iron | Aluminum ‡ | Grayloy-Iron | Aluminum ‡ |
| |  | |  | |  | |  | |  | |
| 1/2 | C17 | C17-SA | LB17 | LB17-SA | LL17 | LL17-SA | LR17 | LR17-SA | T17 | T17-SA |
| 3/4 | C27 | C27-SA | LB27 | LB27-SA | LL27 | LL27-SA | LR27 | LR27-SA | T27 | T27-SA |
| 1 | C37 | C37-SA | LB37 | LB37-SA | LL37 | LL37-SA | LR37 | LR37-SA | T37 | T37-SA |
| 1-1/4 | C47 | C47-SA | LB47 | LB47-SA | LL47 | LL47-SA | LR47 | LR47-SA | T47 | T47-SA |
| 1-1/2 | C57 | C57-SA | LB57 | LB57-SA | LL57 | LL57-SA | LR57 | LR57-SA | T57 | T57-SA |
| 2 | C67 | C67-SA | LB67 | LB67-SA | LL67 | LL67-SA | LR67 | LR67-SA | T67 | T67-SA |
| 2-1/2 | C77 | C77-SA | LB77 | LB77-SA | LL77 | LL77-SA | LR77 | LR77-SA | T77 | T77-SA |
| 3 | C87 | C87-SA | LB87 | LB87-SA | LL87 | LL87-SA | LR87 | LR87-SA | T87 | T87-SA |
| 3-1/2 | — | — | LB97 | LB97-SA | LL97 | LL97-SA | LR97 | LR97-SA | T97 | T97-SA |
| 4 | — | — | LB107 | LB107-SA | LL107 | LL107-SA | LR107 | LR107-SA | T107 | T107-SA |

| Hub Size (inches) | E | | L † | | TA | | TB | | X | |
|----------------------|---|----------|---|----------|---|----------|--|------------|---|------------|
| | Grayloy-Iron | Aluminum | Grayloy-Iron | Aluminum | Grayloy-Iron | Aluminum | Grayloy-Iron | Aluminum ‡ | Grayloy-Iron | Aluminum ‡ |
| |  | |  | |  | |  | |  | |
| 1/2 | E17 | E17-SA | L17 | — | TA17 | — | TB17 | TB17-SA | X17 | X17-SA |
| 3/4 | E27 | E27-SA | L27 | — | TA27 | — | TB27 | TB27-SA | X27 | X27-SA |
| 1 | E37 | E37-SA | L37 | — | TA37 | — | TB37 | TB37-SA | X37 | X37-SA |
| 1-1/4 | — | — | L47 | — | TA47 | — | TB47 | TB47-SA | X47 | X47-SA |
| 1-1/2 | — | — | L57 | — | TA57 | — | TB57 | TB57-SA | X57 | X57-SA |
| 2 | — | — | L67 | — | TA67 | — | TB67 | TB67-SA | X67 | X67-SA |

* Refer to following pages for Wiring Capacity Table.

† L Unilets have double opening and are furnished with one steel cover, assembled.

‡ PVC coating available on select aluminum bodies. Add suffix **-PVC** to catalog number.

FM7™ Unilet® Conduit Outlet Bodies and Covers Wiring Capacity

For use with Rigid Steel, Rigid Aluminum and IMC Conduit.

Fittings
FITTINGS: CONDUIT BODIES

Wiring Capacity: Combine Body and Cover Capacities for Total Usable Capacity per NEC 314.16(A)

| Hub Size (Inches) | Capacity (in ³ /dm ³) | | | | | | | | | Stamped Cover | Cast Cover | |
|---|--|----------------|-----------------|-----------------|----------------|-----------------|----------------|----------------|----------------|----------------|----------------|----------------|
| | C | E | LB | LL LR | L | T | TA | TB | X | | | |
| FM7™ Grayloy™-Iron Bodies and Covers: Threaded | | | | | | | | | | | | |
| 1/2 | 4.00/ 0.07 | 4.00/ 0.07 | 4.00/ 0.07 | 4.00/ 0.07 | 5.00/ 0.08 | 6.00/ 0.10 | 6.00/ 0.10 | 6.00/ 0.10 | 6.00/ 0.10 | 6.00/ 0.10 | 0.30/ 0.00 | 0.40/ 0.01 |
| 3/4 | 7.00/ 0.11 | 7.00/ 0.11 | 7.00/ 0.11 | 7.00/ 0.11 | 9.00/ 0.15 | 10.00/ 0.16 | 10.00/ 0.16 | 10.00/ 0.16 | 10.00/ 0.16 | 10.00/ 0.16 | 0.50/ 0.01 | 0.80/ 0.01 |
| 1 | 11.00/ 0.18 | 11.00/ 0.18 | 11.00/ 0.18 | 11.00/ 0.18 | 13.50/ 0.22 | 15.50/ 0.25 | 15.50/ 0.25 | 15.50/ 0.25 | 15.50/ 0.25 | 15.50/ 0.25 | 1.30/ 0.02 | 1.30/ 0.02 |
| 1-1/4 | 20.00/ 0.33 | — | 20.00/ 0.33 | 20.00/ 0.33 | 22.50/ 0.37 | 20.00/ 0.33 | 20.00/ 0.33 | 20.00/ 0.33 | 20.00/ 0.33 | 20.00/ 0.33 | 1.80/ 0.03 | 2.00/ 0.03 |
| 1-1/2 | 28.00/ 0.46 | — | 28.00/ 0.46 | 28.00/ 0.46 | 31.00/ 0.51 | 28.00/ 0.46 | 28.00/ 0.46 | 28.00/ 0.46 | 28.00/ 0.46 | 28.00/ 0.46 | 2.30/ 0.04 | 3.00/ 0.05 |
| 2 | 50.00/ 0.82 | — | 50.00/ 0.82 | 50.00/ 0.82 | 50.00/ 0.82 | 50.00/ 0.82 | 50.00/ 0.82 | 50.00/ 0.82 | 50.00/ 0.82 | 50.00/ 0.82 | 2.80/ 0.05 | 4.80/ 0.08 |
| 2-1/2 | 102.00/ 1.67 | — | 102.00/ 1.67 | 102.00/ 1.67 | — | 102.00/ 1.67 | — | — | — | — | 9.80/ 0.16 | 9.70/ 0.16 |
| 3 | 133.00/ 2.18 | — | 133.00/ 2.18 | 133.00/ 2.18 | — | 133.00/ 2.18 | — | — | — | — | 9.80/ 0.16 | 9.70/ 0.16 |
| 3-1/2 | — | — | 218.00/ 3.57 | 218.00/ 3.57 | — | 218.00/ 3.57 | — | — | — | — | 16.50/ 0.27 | 16.00/ 0.26 |
| 4 | — | — | 244.00/ 4.00 | 244.00/ 4.00 | — | 244.00/ 4.00 | — | — | — | — | 16.50/ 0.27 | 16.00/ 0.26 |
| FM7™ Aluminum Bodies and Covers: Threaded | | | | | | | | | | | | |
| 1/2 | 4.00/ 0.07 | 4.00/ 0.07 | 4.00/ 0.07 | 4.00/ 0.07 | — | 6.00/ 0.10 | — | — | 6.00/ 0.10 | 6.00/ 0.10 | 0.30/ 0.005 | 0.40/ 0.007 |
| 3/4 | 7.00/ 0.11 | 7.00/ 0.11 | 7.00/ 0.11 | 7.00/ 0.11 | — | 10.00/ 0.16 | — | — | 10.00/ 0.16 | 10.00/ 0.16 | 0.50/ 0.008 | 0.80/ 0.01 |
| 1 | 11.00/ 0.18 | 11.00/ 0.18 | 11.00/ 0.18 | 11.00/ 0.18 | — | 15.50/ 0.25 | — | — | 15.50/ 0.25 | 15.50/ 0.25 | 1.30/ 0.02 | 1.30/ 0.02 |
| 1-1/4 | 20.00/ 0.33 | — | 20.00/ 0.33 | 20.00/ 0.33 | — | 20.00/ 0.33 | — | — | 20.00/ 0.33 | 20.00/ 0.33 | 1.80/ 0.03 | 2.00/ 0.03 |
| 1-1/2 | 28.00/ 0.46 | — | 28.00/ 0.46 | 28.00/ 0.46 | — | 28.00/ 0.46 | — | — | 28.00/ 0.46 | 28.00/ 0.46 | 2.30/ 0.04 | 3.00/ 0.05 |
| 2 | 50.00/ 0.82 | — | 50.00/ 0.82 | 50.00/ 0.82 | — | 50.00/ 0.82 | — | — | 50.00/ 0.82 | 50.00/ 0.82 | 2.80/ 0.05 | 4.80/ 0.08 |
| 2-1/2 | 102.00/ 1.67 | — | 102.00/ 1.67 | 102.00/ 1.67 | — | 102.00/ 1.67 | — | — | — | — | 9.80/ 0.16 | 9.70/ 0.16 |
| 3 | 133.00/ 2.18 | — | 133.00/ 2.18 | 133.00/ 2.18 | — | 133.00/ 2.18 | — | — | — | — | 9.80/ 0.16 | 9.70/ 0.16 |
| 3-1/2 | — | — | 218.00/ 3.57 | 218.00/ 3.57 | — | 218.00/ 3.57 | — | — | — | — | 16.50/ 0.27 | 16.00/ 0.26 |
| 4 | — | — | 244.00/ 4.00 | 244.00/ 4.00 | — | 244.00/ 4.00 | — | — | — | — | 16.50/ 0.27 | 16.00/ 0.26 |

FM7™ Unilet® Conduit Outlet Body Dimensions

For use with Rigid Steel, Rigid Aluminum and IMC Conduit.

Fittings

FITTINGS: CONDUIT BODIES

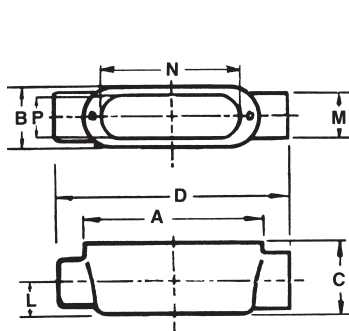

Type C

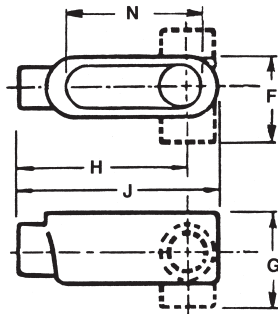

Type E, L, LB, LL, LR

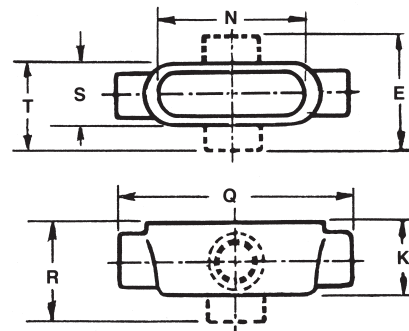

Type T, TA, TB, X

| Hub Size (Inches) | Dimensions in Inches/Millimeters | | | | | | | | | | | | | | | | | |
|-------------------|----------------------------------|-------------|-------------|--------------|-------------|-------------|-------------|--------------|--------------|-------------|------------|-------------|--------------|-------------|--------------|-------------|-------------|-------------|
| | A | B | C | D | E | F | G | H | J | K | L | M | N | P | Q | R | S | T |
| 1/2 | 3.63/ 92.2 | 1.38/ 35.1 | 1.38/ 35.1 | 5.38/ 136.7 | 3.31/ 84.1 | 2.25/ 57.2 | 2.25/ 57.2 | 3.94/ 100.1 | 4.56/ 115.8 | 1.75/ 44.5 | 0.63/ 16.0 | 1.25/ 31.8 | 3.19/ 81.0 | 0.94/ 23.9 | 5.63/ 143.0 | 2.63/ 66.8 | 1.56/ 39.6 | 2.44/ 62.0 |
| 3/4 | 4.25/ 108.0 | 1.56/ 39.6 | 1.63/ 41.4 | 6.00/ 152.4 | 3.50/ 88.9 | 2.44/ 62.0 | 2.50/ 63.5 | 4.44/ 112.8 | 5.19/ 131.8 | 2.00/ 50.8 | 0.75/ 19.1 | 1.50/ 38.1 | 3.81/ 96.8 | 1.13/ 28.7 | 6.25/ 158.8 | 2.88/ 73.2 | 1.88/ 47.8 | 2.63/ 66.8 |
| 1 | 5.00/ 127.0 | 1.75/ 44.5 | 1.88/ 47.8 | 7.00/ 177.8 | 3.88/ 98.6 | 2.75/ 69.9 | 2.88/ 73.2 | 5.19/ 131.8 | 6.00/ 152.4 | 2.25/ 57.2 | 0.88/ 22.4 | 1.75/ 44.5 | 4.50/ 114.3 | 1.38/ 35.1 | 7.25/ 184.2 | 3.25/ 82.6 | 2.00/ 50.8 | 3.00/ 76.2 |
| 1-1/4 | 5.50/ 139.7 | 2.19/ 55.6 | 2.31/ 58.7 | 7.44/ 189.0 | 4.13/ 104.9 | 3.19/ 81.0 | 3.31/ 84.1 | 5.44/ 138.2 | 6.50/ 165.1 | 2.31/ 58.7 | 1.13/ 28.7 | 2.19/ 55.6 | 5.00/ 127.0 | 1.75/ 44.5 | 7.44/ 189.0 | 3.31/ 84.1 | 2.19/ 55.6 | 3.19/ 81.0 |
| 1-1/2 | 6.00/ 152.4 | 2.44/ 62.0 | 2.56/ 65.0 | 8.19/ 208.0 | 4.63/ 117.6 | 3.50/ 88.9 | 3.69/ 93.7 | 5.94/ 150.9 | 7.13/ 181.1 | 2.56/ 65.0 | 1.25/ 31.8 | 2.44/ 62.0 | 5.44/ 138.2 | 1.94/ 49.3 | 8.19/ 208.0 | 3.63/ 92.2 | 2.44/ 62.0 | 3.56/ 90.4 |
| 2 | 7.00/ 177.8 | 3.00/ 76.2 | 3.13/ 79.5 | 9.19/ 233.4 | 5.19/ 131.8 | 4.06/ 103.1 | 4.25/ 108.0 | 6.63/ 168.4 | 8.13/ 206.5 | 3.13/ 79.5 | 1.50/ 38.1 | 3.00/ 76.2 | 6.38/ 162.1 | 2.44/ 62.0 | 9.19/ 233.4 | 4.19/ 106.4 | 3.00/ 76.2 | 4.13/ 104.9 |
| 2-1/2 | 9.00/ 228.6 | 4.25/ 108.0 | 3.63/ 92.2 | 12.00/ 304.8 | — | 5.75/ 146.1 | 5.13/ 130.3 | 8.75/ 222.3 | 10.50/ 266.7 | 3.63/ 92.2 | 1.75/ 44.5 | 3.50/ 88.9 | 8.38/ 212.9 | 3.56/ 90.4 | 12.00/ 304.8 | — | 4.25/ 108.0 | 5.75/ 146.1 |
| 3 | 9.00/ 228.6 | 4.25/ 108.0 | 4.38/ 111.3 | 12.00/ 304.8 | — | 5.75/ 146.1 | 5.88/ 149.4 | 8.38/ 212.9 | 10.50/ 266.7 | 4.38/ 111.3 | 2.13/ 54.1 | 4.25/ 108.0 | 8.38/ 212.9 | 3.56/ 90.4 | 12.06/ 306.3 | — | 4.25/ 108.0 | 5.75/ 146.1 |
| 3-1/2 | 11.00/ 279.4 | 5.25/ 133.4 | 4.88/ 124.0 | — | — | 6.94/ 176.3 | 6.56/ 166.6 | 10.25/ 260.4 | 12.69/ 322.3 | 4.88/ 124.0 | 2.38/ 60.5 | 4.75/ 120.7 | 10.25/ 260.4 | 4.50/ 114.3 | 14.31/ 363.5 | — | 5.25/ 133.4 | 6.94/ 176.3 |
| 4 | 11.00/ 279.4 | 5.25/ 133.4 | 5.38/ 136.7 | — | — | 6.94/ 176.3 | 7.06/ 179.3 | 10.00/ 254.0 | 12.69/ 322.3 | 5.38/ 136.7 | 2.63/ 66.8 | 5.25/ 133.4 | 10.25/ 260.4 | 4.50/ 114.3 | 14.31/ 363.5 | — | 5.25/ 133.4 | 6.94/ 176.3 |

Fraction/Decimal Equivalents (Inches)

| Fraction | Decimal | Fraction | Decimal | Fraction | Decimal | Fraction | Decimal |
|----------|---------|----------|---------|----------|---------|----------|---------|
| 1/16 | 0.06 | 5/16 | 0.31 | 9/16 | 0.56 | 13/16 | 0.81 |
| 1/8 | 0.13 | 3/8 | 0.38 | 5/8 | 0.63 | 7/8 | 0.88 |
| 3/16 | 0.19 | 7/16 | 0.44 | 11/16 | 0.69 | 15/16 | 0.94 |
| 1/4 | 0.25 | 1/2 | 0.50 | 3/4 | 0.75 | 1 | 1.00 |