

**Description**

The ML56 LED downlight system is a flexible solution for your recessed lighting needs. High color fidelity 90 CRI modules are available in three lumen outputs and four color temperatures and because they are compatible with Halo LED housing and many other existing screw based housings, the ML56 LED system can be used in remodel, retrofit and new construction installations. An optional dim-to-warm (D2W™) feature creates an additional lighting solution as it provides a smooth warm transition from 3000K to 1850K when dimmed.

Catalog #		Type
Project		
Comments		Date
Prepared by		

**Specification Features**

**Mechanical**

**Light Module**

- Module includes LED package, LED driver, heat sink, and lens
- Durable die-cast aluminum construction.
- Heat sink designed to conduct heat away from the LED keeping the junction temperatures below specified maximums, including insulated ceiling environments

**Lens**

- Impact-resistant polycarbonate
- Convex form for lamp-like appearance
- High lumen transmission
- Diffusing for even illumination

**Mounting**

- Modules attach to reflector and baffle trims via locking tabs, and attach to eyeballs via keyed twist-to-lock mating bosses
- The complete module and trim assembly installs into housings with precision formed torsion springs located on the trim
- Friction Blade mounting is an alternate option using the accessory 6" Friction Blade Kit model ML56CLIP (order separately). Friction blades provide alternative to torsion springs for retrofit in 6" housings without torsion mounting tabs. ML56CLIP is compatible with 6" baffle and reflector trims only (691, 692, 693, 695, 696 series). For eyeball trim (694 series) use ML7RAB retrofit adapter band.

**Housing Compatibility**

A complete ML56 system includes a LED Module, LED trim, and a compatible housing (new construction, remodel, or existing retrofit). Housing compatibility in the ML56 System is determined by the ML56 trim dimensions. ML56 trims are available in 5" and 6" aperture (5" = 59xx series and 6" = 69xx series trims). Refer to Housing – Trim Section in this document.

**LED**

- 600 Series = 600 design lumens typical.
- Delivered lumens vary depending upon CRI, color temperature, and trim finish.
- Color Temperature options: 2700K, 3000K, 3500K, 4000K
- Dim-to-warm (D2W) Option: 3000K, shifts to 1850K as it DIMS CRI>90 throughout dimming range

- CRI: 90, R9>50
- L70 at 50,000 hours, projected in accordance with IES TM-21

**Color Specification & Quality Standards**

- A tight chromaticity specification ensures LED color uniformity, sustainable Color Rendering Index (CRI) and Correlated Color Temperature (CCT) over the useful life of the LED
- LED color uniformity of 3 SDCM, exceeds ENERGY STAR® color standards per ANSI C78.377- 2008.
- High color performance which maintains 90CRI and R9>50 throughout dimming range.
- Every Halo LED Module is quality tested and performance measured, and then serialized in a permanent record to register lumens, wattage, CRI and CCT.
- Halo LED serialized testing and measurement process ensures color and lumen consistency on a per-unit basis, and validates long-term product consistency over time
- ML56 LED Modules include lumen, CRI, and CCT in the model number
- Example: **ML5606930**  
**56** = 5" / 6" aperture series  
**06** = 600 lumen series  
**9** = >90 CRI  
**30** = 3000K nominal CCT

**Electrical Power Connections**

- LED connector is a non-screw base luminaire disconnect offering easy installation with the matching Halo 5" H550 series and 6" H750 and H2750 series housings (housing selected depends upon LED trim 5" or 6").
- LED Connector is a non-screw base, and where required to qualify as a high-efficacy luminaire.
- The included E26 medium screw-base Edison adapter provides easy retrofit of incandescent housings (see Housing Section).

**Ground Connection**

Separate grounding cable included on the module for attachment to the housing during installation.

**LED Driver**

- Driver is universal voltage 120V-277V, and may be controlled from a switch in this range of main inputs (switchable at 120V, 220V, 230V, 240V, and 277V)
- Driver is dimmable at 120V operation when connected to a compatible dimmer.
- Driver is a high efficiency, electronic power supply providing DC power to the LED.
- Driver meets FCC EMI/RFI Consumer Level limits on 120V main inputs, and is compliant for use in residential and commercial installations.
- Driver features high power factor, low THD, and has integral thermal protection in the event of over temperature or internal failure.
- Driver is replaceable, if replacement should be required.

**Dimming**

Designed for dimming capability to nominal 5% in normal operation with standard 120V Leading Edge (LE) and Trailing Edge (TE) phase control dimmers. (Consult dimmer manufacturer for dimmer compatibility and details. Note, some dimmers require a neutral in the wallbox.)

**Warranty**

Eaton provides a (5) five year limited warranty on the Halo ML56 LED Module.

**LED Module in New or Retrofit Existing Construction – Housings other than Halo**

- If used in recessed housings other than Halo the Eaton 5-year limited warranty applies to the LED Module and Trim only.
- As with any electrical installation, a qualified electrician must ensure compatibility of use with a particular housing; this includes all applicable national and local electrical and building codes. Installer is responsible to properly and securely retain the LED Module and LED Trim in the housing at time of installation.



**ML56 LED System**

**600 Series / 90 CRI**

- ML5606927**
- ML5606930**
- ML5606D2W930**
- ML5606935**
- ML5606940**

**5-Inch and 6-Inch  
600 Lumen LED  
Module for  
New Construction,  
Remodel and Retrofit**

**For use with 59x and 69x  
Series Trims**

**FOR USE IN  
INSULATED CEILING  
AND NON-INSULATED  
CEILING RATED  
HOUSINGS**

**HIGH EFFICACY LED  
WITH INTEGRAL  
DRIVER - DIMMABLE**



**ML5606927**  
5" or 6" LED 600 Series



**ML5606930**  
5" or 6" LED 600 Series



**ML5606D2W930**  
5" or 6" LED 600 Series,  
dim-to-warm



**ML5606935**  
5" or 6" LED 600 Series



**ML5606940**  
5" or 6" LED 600 Series

## Compliance

- cULus listed 1598 Luminaire (Halo housings)
- UL Classified when used in retrofit (refer to housing section)
- cULus listed for damp locations
- cULus Wet location listed with baffle and reflector trims only
- Airtight certified per ASTM E283 (not exceeding 2.0 CFM under 57 Pascals pressure difference)
- IP66 ingress protection rated with baffle and reflector trims only
- RoHS compliant
- May be used in IC (insulated ceiling) housings in direct contact with insulation\* and combustible material
- Can be used for California Title 24 compliance / Title 20 certified
- Can be used for International Energy Conservation Code (IECC) high efficiency luminaire compliance.
- Can be used for Washington State Energy Code compliance
- ENERGY STAR® certified luminaire - consult ENERGY STAR® Certified product list
- EMI/RFI per FCC 47CFR Part 15 Class B Consumer limits (commercial and residential compliant)
- Photometric testing in accordance with IES LM-79
- Lumen maintenance projections in accordance with IES LM-80 and TM-21
- CE Mark - "Conformité Européene" conformity with the Council of European Communities Directives, meeting internationally recognized compliance when used with Halo H550, H750, and H2750 Series LED housings only

\* Not for use with housings in direct contact with spray foam insulation.

## Energy Data

### ML56 600/90 Series

(Values at non-dimming line voltage)
Minimum Starting Temp: -30°C (-22°F)
EMI/RFI: FCC Title 47 CFR, Part 15, (Consumer)
Sound Rating: Class A
Input Voltage: UNV 120V-277V
Power Factor: >0.95 @ 120V and >0.9 @277V
Input Frequency: 50/60Hz
THD: <20%
Max. Rated Wattage: 11W
Input Power: 10.2W
Input Current at 120V: 0.15A
Input Current at 277V: 0.08A
Driver Compliance: UL8750, Class II rated
Maximum IC (Insulated Ceiling) Ambient Continuous Operating Temperature: 25°C (77°F)
Maximum Non-IC Ambient Continuous Operating Temperature: 40°C (104°F)



Refer to ENERGY STAR® Certified Products List.  
 Can be used to comply with California Title 24 High Efficacy requirements.  
 Certified to California Title 20 Appliance Efficiency Database.



## Dimensions

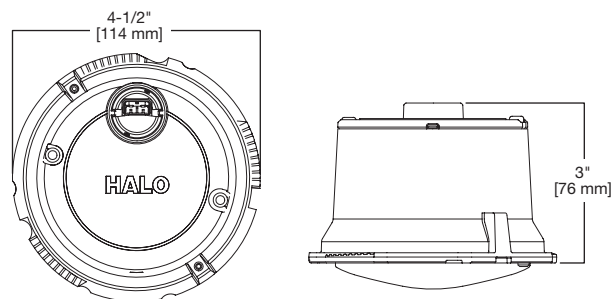

## Ordering Information

Sample Number: **ML5606930 593WB**

Order LED Module and trim separately.

A complete system also includes a compatible housing (new construction, remodel, or existing retrofit). Housing aperture size in the ML56 System is determined by the ML56 trim dimensions. ML56 trims are available in 5" and 6" aperture (5" = 59xx series and 6" = 69xx series trims). Refer to Housing Section in this document.

### ML56 LED Modules 600 Series / 90 CRI

**ML5606927**= 5"/6" LED module, 600 lumen, 90CRI, 2700K  
**ML5606930**= 5"/6" LED module, 600 lumen, 90CRI, 3000K  
**ML5606935**= 5"/6" LED module, 600 lumen, 90CRI, 3500K  
**ML5606940**= 5"/6" LED module, 600 lumen, 90CRI, 4000K  
**ML5606D2W930**= 5"/6" dim-to-warm LED module, 600 lumen, 90CRI, 3000K to 1850K

### ML56 LED 5" and 6" Trims

#### 590 Series - 5" LED Trims

**591WB**=5" LED trim, polymer "dead-front", shallow white baffle & flange – shallow and standard housings (For use with 600 Series LED light modules only)  
**592SC**=5" LED trim, specular reflector & white flange  
**592H**=5" LED trim, haze reflector & white flange  
**592W**=5" LED trim, white reflector & flange  
**593WB**=5" LED trim, white micro-step baffle & flange  
**593BB**=5" LED trim, black micro-step baffle & white flange  
**593SNB**=5" LED trim, satin nickel micro-step baffle & flange  
**593TBZB**=5" LED trim, tuscan bronze micro-step baffle & flange  
**594WB**=5" LED directional trim, white eyeball, baffle & flange – shallow and standard housings  
**594SNB**=5" LED directional trim, satin nickel eyeball, baffle & flange – shallow and standard housings  
**594TBZB**=5" LED directional trim, tuscan bronze eyeball, baffle & flange – shallow and standard housings  
**595WW**=5" LED trim, wall wash - specular reflector, repositionable specular kick reflector, white flange  
**596WB**=5" LED trim, white shallow baffle & flange – shallow and standard housings

#### 690 Series - 6" LED Trims

**691WB**=6" LED trim, polymer "dead-front", white shallow baffle & flange – shallow and standard housings (For use with 600 Series LED light modules only)  
**692SC**=6" LED trim, specular reflector & white flange  
**692H**=6" LED trim, haze reflector & white flange  
**692W**=6" LED trim, white reflector & flange  
**693WB**=6" LED trim, white micro-step baffle & flange  
**693BB**=6" LED trim, black micro-step baffle & white flange  
**693SNB**=6" LED trim, satin nickel micro-step baffle & flange  
**693TBZB**=6" LED trim, tuscan bronze micro-step baffle & flange  
**694WB**=6" LED directional trim, white eyeball, baffle & flange – shallow and standard housings  
**694SNB**=6" LED directional trim, satin nickel eyeball, baffle & flange – shallow and standard housings  
**694TBZB**=6" LED directional trim, tuscan bronze eyeball, baffle & flange – shallow and standard housings  
**695WW**=6" LED trim, wall wash - specular reflector, repositionable specular kick reflector, white flange  
**696WB**=6" LED trim, white shallow baffle & flange – for use with shallow and standard housings

### ML56 System Accessories

**ML56CLIP**=Friction clip mounting kit - For retrofitting non-torsion spring housings, 6" clips\*  
**WW595SC**=5" Wall wash insert - kick reflector for 595WW (1-included with trim) double or corner wall wash\*\*  
**WW695SC**=6" Wall wash insert - kick reflector for 695WW (1-included with trim) double or corner wall wash\*\*  
**TRM590WH**=5" LED oversize trim ring for use with 59" series trims, white 6.3" I.D., 7.5" O.D. Ring slips over LED trim. Inset design allows 5" trim to fit into oversize ring for an even trim surface  
**TRM690WH**=6" LED oversize trim ring for use with 69" series trims, white 6.9" I.D., 9.5" O.D. Ring slips over LED trim. Inset design allows 6" trim to fit into oversize ring for an even trim surface

\*ML56CLIP is compatible with 6" baffle and reflector trims only (691, 692, 693, 695, 696 series). For eyeball trim (694 series) use ML7RAB retrofit adapter band.

\*\*Wall wash trims 595WW and 695WW Feature an exclusive repositionable kick reflector for fine-tuning adjustment of the wall wash effect. The WW595SC and WW695SC are repositionable kick reflectors sold separately for addition to the wall wash trim when a double or corner wall wash is needed, or for replacement of original kick reflector included with the trim.

## Lighting Facts

### ML5606927

PRODUCT SPECIFICATIONS	
Lumens (Light Output)	<b>596</b>
Watts	<b>10.2</b>
Lumens Per Watt (Efficacy)	<b>57.1</b>
Color Accuracy (CRI)	<b>92</b>
Light Color (CCT)	<b>2700K</b>
Correlated Color Temperature (CCT)	
MODEL# ML5606927	

### ML5606930

PRODUCT SPECIFICATIONS	
Lumens (Light Output)	<b>655</b>
Watts	<b>10.2</b>
Lumens Per Watt (Efficacy)	<b>59.4</b>
Color Accuracy (CRI)	<b>94</b>
Light Color (CCT)	<b>3000K</b>
Correlated Color Temperature (CCT)	
MODEL# ML5606930	

### ML5606D2W930

PRODUCT SPECIFICATIONS	
Lumens (Light Output)	<b>655</b>
Watts	<b>10.2</b>
Lumens Per Watt (Efficacy)	<b>59.4</b>
Color Accuracy (CRI)	<b>94</b>
Light Color (CCT)	<b>3000K</b>
Correlated Color Temperature (CCT)	
MODEL# ML5606930	

### ML5606935

PRODUCT SPECIFICATIONS	
Lumens (Light Output)	<b>672</b>
Watts	<b>10.2</b>
Lumens Per Watt (Efficacy)	<b>65.9</b>
Color Accuracy (CRI)	<b>94</b>
Light Color (CCT)	<b>3500K</b>
Correlated Color Temperature (CCT)	
MODEL# ML5606935	

### ML5606940

PRODUCT SPECIFICATIONS	
Lumens (Light Output)	<b>709</b>
Watts	<b>10.2</b>
Lumens Per Watt (Efficacy)	<b>69.5</b>
Color Accuracy (CRI)	<b>93</b>
Light Color (CCT)	<b>4000K</b>
Correlated Color Temperature (CCT)	
MODEL# ML5606940	

## Housing – Trim Compatibility

Housing compatibility in the ML56 System is determined by the ML56 trim dimensions. ML56 trims are available in 5" and 6" aperture (5" = 59xx series and 6" = 69xx series trims). Refer to ML56 TRIMS in this document. (Note "X" in the trim model number denotes finish code.)

## Housing – Compatibility

The ML56 LED module - trim combination is cULus Listed or UL Classified for use with any 5" or 6" diameter recessed housing constructed of steel or aluminum with an internal volume that exceeds 115 in<sup>3</sup> in addition to those noted below.

## Halo UL Listed Compatibility

**6" Trims: 691X, 692X, 693X, 694X, 695X, 696X**

(Note shallow housings for use with 691X, 694X, 696X trims only)

## HALO - LED Housings with LED Luminaire Connector - High-Efficacy Compliant

Brand	Housing Type	Catalog Number	Description
Halo	Standard Housings	H750ICAT	6" LED, Insulated Ceiling, Air-Tite, New Construction Housing
		H750RICAT	6" LED, Insulated Ceiling, Air-Tite, Remodel Housing
		H750T	6" LED, Non-IC, Air-Tite, New Construction Housing
		H750TCP	6" LED, Non-IC, New Construction/Remodel Chicago Plenum Housing
Halo	Shallow Housings	H2750ICAT	6" LED, Shallow, Insulated Ceiling, Air-Tite, New Constr. (use with 691X, 694X, 696X trims only)
		H2750RICAT	6" LED, Shallow, Insulated Ceiling, Air-Tite, Remodel (use with 691X, 694X, 696X trims only)

## HALO - Incandescent E26 Screwbase Housings

Brand	Housing Type	Catalog Number	Description
Halo	Standard Housings	H7ICAT	6" Insulated Ceiling, Air-Tite New Construction Housing
		H7RICAT	6" Insulated Ceiling, Air-Tite Remodel Housing
		H7ICT	6" Insulated Ceiling, New Construction Housing
		H7RICT	6" Insulated Ceiling, Remodel Housing
		H7ICATNB	6" Insulated Ceiling, Air-Tite New Construction Housing, No Socket Bracket
		H7ICTNB	6" Insulated Ceiling, New Construction Housing, No Socket Bracket
		H7T	6" Non-IC, New Construction Housing
		H7RT	6" Non-IC, Remodel Housing
		H7TNB	6" Non-IC, New Construction Housing, No Socket Bracket
		H7TCP	6" Non-IC, Chicago Plenum, New Construction/Remodel Housing
		H7UICAT	6" Insulated Ceiling, Universal, Air-Tite, New Construction Housing
		E7ICAT	6" IC, Air-Tite, New Construction Housing, 120V
		E7ICATNB	6" IC, AIRTITE, New Construction, No Socket Bracket Housing, 120V
		E7TAT	6" Non-IC, Air-Tite, New Construction Housing, 120V
		E7TATNB	6" Non-IC, Air-Tite, New Construction, No Socket Bracket Housing, 120V
		E27ICAT	6" IC, Air-Tite, Shallow New Construction Housing, 120V
		E27TAT	6" Non-IC, Air-Tite, Shallow New Construction Housing, 120V
		E7RICAT	6" IC, Air-Tite, Remodel Housing, 120V
		E7RTAT	6" Non-IC, Air-Tite, Remodel Housing, 120V
		Halo	Shallow Housings
H27RICAT	6" Shallow, Insulated Ceiling, Air-Tite Remodel Housing (use with 691X, 694X, 696X trims only)		
H27ICT	6" Shallow, Insulated Ceiling, New Construction Housing (use with 691X, 694X, 696X trims only)		
H27RICT	6" Shallow, Insulated Ceiling, Remodel Housing (use with 691X, 694X, 696X trims only)		
H27T	6" Shallow, Non-IC, New Construction Housing (use with 691X, 694X, 696X trims only)		
H27RT	6" Shallow, Non-IC, Remodel Housing (use with 691X, 694X, 696X trims only)		
E27RICAT	6" IC, Air-Tite, Shallow Remodel Housing, 120V		
E27RTAT	6" Non-IC, Air-Tite, Shallow Remodel Housing, 120V		

## Halo LED Retrofit Enclosures

Brand	Type	Catalog Number	Description
Halo	Retrofit	ML7BXRFK	6" Retrofit Enclosure, Non-IC, BX Whip
		ML7E26RFK	6" Retrofit Enclosure, Non-IC, E26 Screw base Interface

## Housing Compatibility

5" Trims: 591X, 592X, 593X, 594X, 595X, 596X

(Note shallow housings for use with 591X, 594X, 596X trims only)

### HALO - LED Housings with LED Luminaire Connector - High-Efficacy Compliant

Brand	Housing Type	Catalog Number	Description
Halo	Standard Housings	H550ICAT	5" LED, Insulated Ceiling, Air-Tite, New Construction Housing
		H550RICAT	5" LED, Insulated Ceiling, Air-Tite, Remodel Housing

### HALO - Incandescent E26 Screwbase Housings

Brand	Housing Type	Catalog Number	Description		
Halo	Standard Housings	H5ICAT	5" Insulated Ceiling, Air-Tite New Construction Housing		
		H5RICAT	5" Insulated Ceiling, Air-Tite Remodel Housing		
		H5ICATNB	5" IC, Air-Tite New Construction, No Socket Bracket Housing, 120V		
		H5T	5" Non-IC, New Construction Housing		
		H5RT	5" Non-IC, Remodel Housing		
		H5TNB	5" Non-IC, New Construction, No Socket Bracket Housing, 120V		
		E5ICAT	5" IC, Air-Tite, New Construction Housing, 120V		
		E5ICATNB	5" IC, Air-Tite, New Construction, No Socket Bracket Housing, 120V		
		E5TAT	5" Non-IC, Air-Tite, New Construction Housing, 120V		
		E5TATNB	5" Non-IC, Air-Tite, New Construction, No Socket Bracket Housing, 120V		
		E5RICAT	5" IC, Air-Tite, Remodel Housing, 120V		
		E5RTAT	5" Non-IC, Air-Tite, Remodel Housing, 120V		
		Halo	Shallow Housings	H25ICAT	5" Shallow, Insulated Ceiling, Air-Tite New Construction (use with 591X, 594X, 596X trims only)
				H25ICATNB	5" IC, Air-Tite Shallow, New Const., No Socket Bracket Housing, 120V

### Housings - UL Classified for Retrofit Compatibility

6" Trims: 691X, 692X, 693X, 694X, 695X, 696X

(Note shallow housings for use with 691X, 694X, 696X trims only)

Brand	Housing Type	Catalog Number
Juno	Standard Housings	IC22, IC22R, IC22W, IC22S, IC23, IC23W, TC2, TC2R, IC2
	Shallow Housing	IC21, IC21R (use with 691X, 694X, 696X trims only)
Capri	Standard Housings	CR1, PR1, QL1
	Shallow Housing	R9ASIC/PS9RM (use with 691X, 694X, 696X trims only)
Elco		HL7ICA (EL7ICA)
Lithonia	Standard Housings	LC6, L7X
	Shallow Housing	L7XP (use with 691X, 694X, 696X trims only)
Thomas		PS1
Commercial Electric		C7ICA, H3
Progress	Standard Housings	P87-AT † *
	Shallow Housing	P86TG (use with 691X, 694X, 696X trims only)
Lightolier		1104ICS †*, 1104ICR †*

† Requires replacement of torsion springs with Friction Clips. Order Friction Clip Kit separately: ML56CLIP

\* ML56CLIP is compatible with only baffle and reflector trims

5" Trims: 591X, 596X

Brand	Housing Type	Catalog Number
Juno	Standard Housings	IC20, IC25S, IC25W, TC20

**ML56 600 Series Compliance Table**

90 CRI LED Modules with ML56 Trims

	ML5606927	ML5606930	ML5606D2W930	ML5606935	ML5606940
593BB	IECC	IECC	IECC	IECC	T24, IECC
693BB	IECC	T24, IECC	T24, IECC	T24, IECC	T24, IECC
593TBZB	IECC	T24, IECC	T24, IECC	T24, IECC	T24, IECC
693TBZB	IECC	T24, IECC	T24, IECC	T24, IECC	T24, IECC
593SNB	T24, IECC	T24, IECC	T24, IECC	T24, IECC	T24, IECC
693SNB	T24, IECC	T24, IECC	T24, IECC	T24, IECC	ES,T24, IECC
592H	T24, IECC	ES,T24, IECC	ES,T24, IECC	ES,T24, IECC	ES,T24, IECC
592W	T24, IECC	ES,T24, IECC	ES,T24, IECC	ES,T24, IECC	ES,T24, IECC
593WB	T24, IECC	ES,T24, IECC	ES,T24, IECC	ES,T24, IECC	ES,T24, IECC
592SC	ES,T24, IECC	ES,T24, IECC	ES,T24, IECC	ES,T24, IECC	ES,T24, IECC
692H	ES,T24, IECC	ES,T24, IECC	ES,T24, IECC	ES,T24, IECC	ES,T24, IECC
595WW	ES,T24, IECC	ES,T24, IECC	ES,T24, IECC	ES,T24, IECC	ES,T24, IECC
695WW	ES,T24, IECC	ES,T24, IECC	ES,T24, IECC	ES,T24, IECC	ES,T24, IECC
693WB	ES,T24, IECC	ES,T24, IECC	ES,T24, IECC	ES,T24, IECC	ES,T24, IECC
692SC	ES,T24, IECC	ES,T24, IECC	ES,T24, IECC	ES,T24, IECC	ES,T24, IECC
692W	ES,T24, IECC	ES,T24, IECC	ES,T24, IECC	ES,T24, IECC	ES,T24, IECC
596WB	ES,T24, IECC	ES,T24, IECC	ES,T24, IECC	ES,T24, IECC	ES,T24, IECC
694TBZB	ES,T24, IECC	ES,T24, IECC	ES,T24, IECC	ES,T24, IECC	ES,T24, IECC
594TBZB	ES,T24, IECC	ES,T24, IECC	ES,T24, IECC	ES,T24, IECC	ES,T24, IECC
696WB	ES,T24, IECC	ES,T24, IECC	ES,T24, IECC	ES,T24, IECC	ES,T24, IECC
694SNB	ES,T24, IECC	ES,T24, IECC	ES,T24, IECC	ES,T24, IECC	ES,T24, IECC
594SNB	ES,T24, IECC	ES,T24, IECC	ES,T24, IECC	ES,T24, IECC	ES,T24, IECC
694WB	ES,T24, IECC	ES,T24, IECC	ES,T24, IECC	ES,T24, IECC	ES,T24, IECC
594WB	ES,T24, IECC	ES,T24, IECC	ES,T24, IECC	ES,T24, IECC	ES,T24, IECC
594WB-30	ES,T24, IECC	ES,T24, IECC	ES,T24, IECC	ES,T24, IECC	ES,T24, IECC
694WB-30	ES,T24, IECC	ES,T24, IECC	ES,T24, IECC	ES,T24, IECC	ES,T24, IECC

**Code Descriptions:**

ES = ENERGY STAR® Certified Luminaire

T24 = Can be used to comply with California Title 24 High Efficacy requirements. Certified to California Title 20 Appliance Efficiency Database.

IECC = International Energy Conservation Code "High Efficacy"

**ML56 600 Series Lumen Table**

90 CRI LED Modules with ML56 trims

	Trim Catalog #	ML5606927		ML5606930		ML5606D2W930		ML5606935		ML5606940	
		Lumens	LPW	Lumens	LPW	Lumens	LPW	Lumens	LPW	Lumens	LPW
0° Tilt Angle	593BB	393.0	38.5	431.9	42.3	480.7	50.3	443.1	43.4	467.5	45.8
	693BB	435.0	42.6	478.1	46.9	532.1	55.7	490.5	48.1	517.5	50.7
	593TBZB	441.0	43.2	484.7	47.5	539.4	56.4	497.2	48.7	524.6	51.4
	693TBZB	457.0	44.8	502.2	49.2	559.0	58.5	515.3	50.5	543.6	53.3
	593SNB	489.0	47.9	537.4	52.7	598.2	62.6	551.4	54.1	581.7	57.0
	693SNB	505.0	49.5	555.0	54.4	617.7	64.6	569.4	55.8	600.7	58.9
	592H	551.0	54.0	605.5	59.4	674.0	70.5	621.3	60.9	655.5	64.3
	592W	568.0	55.7	624.2	61.2	694.8	72.7	640.4	62.8	675.7	66.2
	593WB	578.0	56.7	635.2	62.3	707.0	74.0	651.7	63.9	687.6	67.4
	592SC	582.0	57.1	639.6	62.7	711.9	74.5	656.2	64.3	692.3	67.9
	692H	584.0	57.3	641.8	62.9	714.4	74.7	658.5	64.6	694.7	68.1
	595WW	586.0	57.5	644.0	63.1	716.8	75.0	660.7	64.8	697.1	68.3
	695WW	587.0	57.5	645.1	63.2	718.0	75.1	661.9	64.9	698.3	68.5
	693WB	596.0	58.4	655.0	64.2	729.0	76.3	672.0	65.9	709.0	69.5
	692SC	596.0	58.4	655.0	64.2	729.0	76.3	672.0	65.9	709.0	69.5
	692W	598.0	58.6	657.2	64.4	731.5	76.5	674.3	66.1	711.4	69.7
	596WB	609.0	59.7	669.3	65.6	744.9	77.9	686.7	67.3	724.5	71.0
	694TBZB	614.0	60.2	674.8	66.2	751.1	78.6	692.3	67.9	730.4	71.6
	594TBZB	615.0	60.3	675.9	66.3	752.3	78.7	693.4	68.0	731.6	71.7
	696WB	619.0	60.7	680.3	66.7	757.2	79.2	697.9	68.4	736.4	72.2
694SNB	627.0	61.5	689.1	67.6	767.0	80.2	707.0	69.3	745.9	73.1	
594SNB	629.0	61.7	691.3	67.8	769.4	80.5	709.2	69.5	748.3	73.4	
694WB	648.0	63.5	712.1	69.8	792.7	82.9	730.6	71.6	770.9	75.6	
594WB	650.0	63.7	714.3	70.0	795.1	83.2	732.9	71.9	773.2	75.8	
30° Tilt Angle	594WB-30	630.0	70.0	692.4	76.9	770.6	80.6	710.3	78.9	749.4	83.3
	694WB-30	602.0	66.9	661.6	73.5	736.4	77.0	678.8	75.4	716.1	79.6

Photometry 5" Trims • 600 Series • 90 CRI

Multiplier Table

CCT Option	2700 K	3000 K	3500 K	4000 K
CCT Multiplier	0.91	1.00	1.03	1.08

Table based upon testing with 3000°K color temperature, 90CRI.

Multipliers may be used to determine relative lumen values with other color temperatures.

ML5606930-592SC

Test Number	P130232
Light Module	600 Series, 90CRI
Trim	5" Aperture, Specular Clear Trim
Lumens	640
Efficacy	62.7 Lm/W
SC	1.06

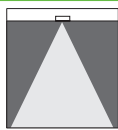

Cone of Light

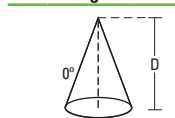

D	FC	L	W
5.5	15.4	5.8	5.8
7	9.5	7.2	7.2
8	7.3	8.4	8.4
9	5.7	9.4	9.4
10	4.6	10.4	10.4
12	3.2	12.6	12.6

Candlepower Distribution

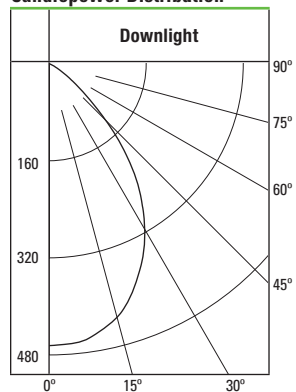

Zonal Lumen Summary

Zone	Lumens	%Fixture
0-30	331	51.7
0-40	493	77
0-60	631	98.7
0-90	640	100
90-180	0	0
0-180	640	100

ML5606930-594WB

Test Number	P130280
Light Module	600 Series, 90CRI
Trim	5" Aperture, Directional Eyeball
Lumens	714
Efficacy	70 Lm/W
SC	1.22

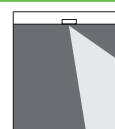

Candlepower Distribution

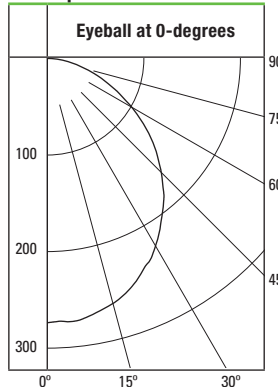

Zonal Lumen Summary

Zone	Lumens	%Fixture
0-30	210	29.4
0-40	339	47.5
0-60	579	81
0-90	714	100
90-180	0	0
0-180	714	100

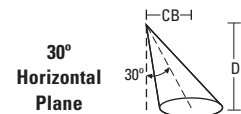

D	FC	L	W	CB
5.5	8	6.6	6.6	3.2
7	4.9	8.3	8.4	4
8	3.8	9.6	9.8	4.6
9	3	10.7	11	5.2
10	2.4	12	12.2	5.8
12	1.7	14.3	14.6	6.9

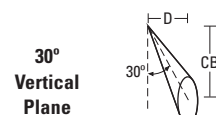

D	FC	L	W	CB
1'	156	1.1	1.2	1.7
2'	39	2.2	2.6	3.5
3'	17.3	3.3	3.8	5.2
4'	9.7	4.5	5.2	6.9
5'	6.2	5.6	6.6	8.7
6'	4.3	6.7	7.8	10.4

Candlepower Distribution

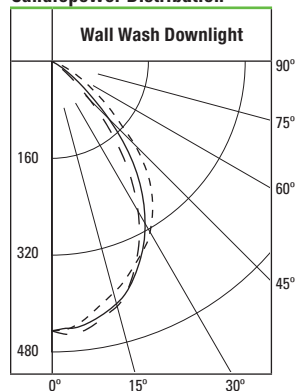

ML5606930-595WW

Test Number	P130304
Light Module	600 Series, 90CRI
Trim	5" Aperture, Wall Wash with Specular Clear Trim and Specular Clear Kick Reflector
Lumens	644
Efficacy	63.1 Lm/W
SC	1.06

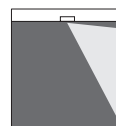

Zonal Lumen Summary

Zone	Lumens	%Fixture
0-30	316	49
0-40	475	73.8
0-60	627	97.3
0-90	644	100
90-180	0	0
0-180	644	100

Single Unit Footcandles

2.5' From Wall (Distance From Fixture Along Wall)

DD	●	1'	2'	3'	4'	5'	6'
1'	2.7	1.7	0.7	0.2	0.1	0	0
2'	9.2	6.6	2.9	0.9	0.3	0.1	0
3'	10.5	8.7	4.7	1.9	0.7	0.2	0.1
4'	7.4	6.6	4.8	2.6	1.1	0.5	0.2
5'	4.9	4.6	3.7	2.5	1.4	0.7	0.3
6'	3.3	3.1	2.7	2	1.4	0.8	0.4
7'	2.3	2.2	2	1.6	1.2	0.8	0.5
8'	1.6	1.6	1.5	1.2	1	0.7	0.5
9'	1.2	1.2	1.1	1	0.8	0.6	0.5
10'	0.9	0.9	0.8	0.7	0.6	0.5	0.4

Multiple Unit Footcandles

2.5' From Wall (Distance From Fixture Along Wall)

DD	--3'--	--4'--
1'	2.9 2.3 2.9	2.8 1.3 2.8
2'	10.1 9.3 10.1	9.5 5.8 9.5
3'	12.5 13.7 12.5	11.3 9.5 11.3
4'	10.1 11.7 10.1	8.6 9.5 8.6
5'	7.4 8.4 7.4	6.4 7.3 6.4
6'	5.3 5.9 5.3	4.7 5.4 4.7
7'	3.9 4.2 3.9	3.5 3.9 3.5
8'	2.9 3.1 2.9	2.6 2.9 2.6
9'	2.2 2.3 2.2	2 2.2 2
10'	1.7 1.8 1.7	1.6 1.7 1.6

Legend

0-deg: - - - - -	Wall
90-deg: — — — — —	Side
180-deg: — — — — —	Room

Photometric tests are per IES measurement standards. Tests represent typical fixture performance. Field results may vary.

Photometry 6" Trims • 600 Series • 90 CRI

Multiplier Table

CCT Option	2700 K	3000 K	3500 K	4000 K
CCT Multiplier	0.91	1.00	1.03	1.08

Table based upon testing with 3000°K color temperature, 90CRI.

Multipliers may be used to determine relative lumen values with other color temperatures.

ML5606930-692SC

Test Number	P130320
Light Module	600 Series, 90CRI
Trim	6" Aperture, Specular Clear Trim
Lumens	655
Efficacy	64.2 Lm/W
SC	0.66



Cone of Light

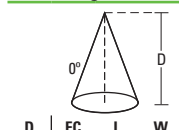

D	FC	L	W
5.5	25.4	3.6	3.6
7	15.7	4.6	4.6
8	12	5.2	5.2
9	9.5	5.8	5.8
10	7.7	6.6	6.6
12	5.3	7.8	7.8

Candlepower Distribution

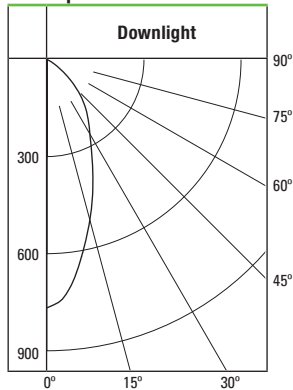

Zonal Lumen Summary

Zone	Lumens	%Fixture
0-30	361	55.1
0-40	499	76.3
0-60	647	98.7
0-90	655	100
90-180	0	0
0-180	655	100

ML5606930-694WB

Test Number	P130376
Light Module	600 Series, 90CRI
Trim	6" Aperture, Directional Eyeball
Lumens	712
Efficacy	69.8 Lm/W
SC	1.21

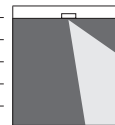

Candlepower Distribution

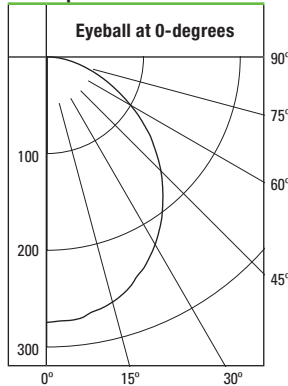

Zonal Lumen Summary

Zone	Lumens	%Fixture
0-30	210	29.5
0-40	339	47.6
0-60	577	81.1
0-90	712	100
90-180	0	0
0-180	712	100

30° Horizontal Plane

D	FC	L	W	CB
5.5	8	6.5	6.6	3.2
7	4.9	8.3	8.6	4
8	3.8	9.6	9.8	4.6
9	3	10.7	11	5.2
10	2.4	11.9	12.2	5.8
12	1.7	14.3	14.6	6.9

30° Vertical Plane

D	FC	L	W	CB
1'	155	1.1	1.2	1.7
2'	38.8	2.2	2.6	3.5
3'	17.2	3.3	3.8	5.2
4'	9.7	4.5	5.2	6.9
5'	6.2	5.6	6.6	8.7
6'	4.3	6.7	7.8	10.4

Candlepower Distribution

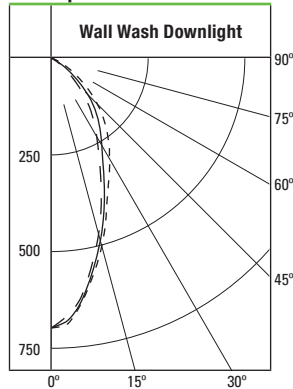

ML5606930-695WW

Test Number	P130400
Light Module	600 Series, 90CRI
Trim	6" Aperture, Wall Wash with Specular Clear Trim and Specular Clear Kick Reflector
Lumens	645
Efficacy	63.2 Lm/W
SC	0.69

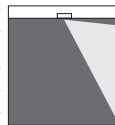

Zonal Lumen Summary

Zone	Lumens	%Fixture
0-30	345	53.5
0-40	482	74.7
0-60	630	97.7
0-90	645	100
90-180	0	0
0-180	645	100

Single Unit Footcandles

2.5' From Wall (Distance From Fixture Along Wall)

DD	●	1'	2'	3'	4'	5'	6'
1'	1.9	1.1	0.4	0.1	0	0	0
2'	8.5	6.1	2.6	0.8	0.2	0.1	0
3'	9	7.4	4.3	1.9	0.7	0.2	0.1
4'	6.7	5.8	4	2.3	1.1	0.5	0.2
5'	4.8	4.3	3.2	2.1	1.3	0.7	0.3
6'	3.4	3.1	2.5	1.8	1.2	0.8	0.4
7'	2.6	2.3	1.9	1.4	1	0.7	0.5
8'	2	1.8	1.5	1.2	0.9	0.6	0.5
9'	1.5	1.4	1.2	1	0.7	0.5	0.4
10'	1.2	1.1	1	0.8	0.6	0.5	0.4

Multiple Unit Footcandles

2.5' From Wall (Distance From Fixture Along Wall)

DD	--3'--	--4'--	
1'	2	1.4	2
2'	9.3	8.4	9.3
3'	10.9	11.7	10.9
4'	9.1	9.9	9.1
5'	6.9	7.5	6.9
6'	5.2	5.6	5.2
7'	4	4.3	4
8'	3.1	3.3	3.1
9'	2.5	2.6	2.5
10'	2	2.1	2

Legend

0-deg:	---	Wall
90-deg:	---	Side
180-deg:	---	Room

Photometric tests are per IES measurement standards. Tests represent typical fixture performance. Field results may vary.



**Description**

The ML56 LED downlight system is a flexible solution for your recessed lighting needs. High color fidelity 90 CRI modules are available in three lumen outputs and four color temperatures and because they are compatible with Halo LED housing and many other existing screw based housings, the ML56 LED system can be used in remodel, retrofit and new construction installations. An optional dim-to-warm (D2W™) feature creates an additional lighting solution as it provides a smooth warm transition from 3000K to 1850K when dimmed.

Catalog #		Type
Project		
Comments		Date
Prepared by		

**Specification Features**

**Mechanical**

**Light Module**

- Module includes LED package, LED driver, heat sink, and lens
- Durable die-cast aluminum construction.
- Heat sink designed to conduct heat away from the LED keeping the junction temperatures below specified maximums, including insulated ceiling environments

**Lens**

- Impact-resistant polycarbonate
- Convex form for lamp-like appearance
- High lumen transmission
- Diffusing for even illumination

**Mounting**

- Modules attach to reflector and baffle trims via locking tabs, and attach to eyeballs via keyed twist-to-lock mating bosses
- The complete module and trim assembly installs into housings with precision formed torsion springs located on the trim
- Friction Blade mounting is an alternate option using the accessory 6" Friction Blade Kit model ML56CLIP (order separately). Friction blades provide alternative to torsion springs for retrofit in 6" housings without torsion mounting tabs. ML56CLIP is compatible with 6" baffle and reflector trims only (691, 692, 693, 695, 696 series). For eyeball trim (694 series) use ML7RAB retrofit adapter band.

**Housing Compatibility**

A complete ML56 system includes a LED Module, LED trim, and a compatible housing (new construction, remodel, or existing retrofit). Housing compatibility in the ML56 System is determined by the ML56 trim dimensions. ML56 trims are available in 5" and 6" aperture (5" = 59xx series and 6" = 69xx series trims). Refer to Housing – Trim Section in this document.

**LED**

- 600 Series = 600 design lumens typical.
- Delivered lumens vary depending upon CRI, color temperature, and trim finish.
- Color Temperature options: 2700K, 3000K, 3500K, 4000K
- Dim-to-warm (D2W) Option: 3000K, shifts to 1850K as it DIMS CRI>90 throughout dimming range

- CRI: 90, R9>50
- L70 at 50,000 hours, projected in accordance with IES TM-21

**Color Specification & Quality Standards**

- A tight chromaticity specification ensures LED color uniformity, sustainable Color Rendering Index (CRI) and Correlated Color Temperature (CCT) over the useful life of the LED
- LED color uniformity of 3 SDCM, exceeds ENERGY STAR® color standards per ANSI C78.377- 2008.
- High color performance which maintains 90CRI and R9>50 throughout dimming range.
- Every Halo LED Module is quality tested and performance measured, and then serialized in a permanent record to register lumens, wattage, CRI and CCT.
- Halo LED serialized testing and measurement process ensures color and lumen consistency on a per-unit basis, and validates long-term product consistency over time
- ML56 LED Modules include lumen, CRI, and CCT in the model number
- Example: **ML5606930**  
**56** = 5" / 6" aperture series  
**06** = 600 lumen series  
**9** = >90 CRI  
**30** = 3000K nominal CCT

**Electrical Power Connections**

- LED connector is a non-screw base luminaire disconnect offering easy installation with the matching Halo 5" H550 series and 6" H750 and H2750 series housings (housing selected depends upon LED trim 5" or 6").
- LED Connector is a non-screw base, and where required to qualify as a high-efficacy luminaire.
- The included E26 medium screw-base Edison adapter provides easy retrofit of incandescent housings (see Housing Section).

**Ground Connection**

Separate grounding cable included on the module for attachment to the housing during installation.

**LED Driver**

- Driver is universal voltage 120V-277V, and may be controlled from a switch in this range of main inputs (switchable at 120V, 220V, 230V, 240V, and 277V)
- Driver is dimmable at 120V operation when connected to a compatible dimmer.
- Driver is a high efficiency, electronic power supply providing DC power to the LED.
- Driver meets FCC EMI/RFI Consumer Level limits on 120V main inputs, and is compliant for use in residential and commercial installations.
- Driver features high power factor, low THD, and has integral thermal protection in the event of over temperature or internal failure.
- Driver is replaceable, if replacement should be required.

**Dimming**

Designed for dimming capability to nominal 5% in normal operation with standard 120V Leading Edge (LE) and Trailing Edge (TE) phase control dimmers. (Consult dimmer manufacturer for dimmer compatibility and details. Note, some dimmers require a neutral in the wallbox.)

**Warranty**

Eaton provides a (5) five year limited warranty on the Halo ML56 LED Module.

**LED Module in New or Retrofit Existing Construction – Housings other than Halo**

- If used in recessed housings other than Halo the Eaton 5-year limited warranty applies to the LED Module and Trim only.
- As with any electrical installation, a qualified electrician must ensure compatibility of use with a particular housing; this includes all applicable national and local electrical and building codes. Installer is responsible to properly and securely retain the LED Module and LED Trim in the housing at time of installation.



**ML56 LED System**

**600 Series / 90 CRI**

- ML5606927**
- ML5606930**
- ML5606D2W930**
- ML5606935**
- ML5606940**

**5-Inch and 6-Inch  
600 Lumen LED  
Module for  
New Construction,  
Remodel and Retrofit**

**For use with 59x and 69x  
Series Trims**

**FOR USE IN  
INSULATED CEILING  
AND NON-INSULATED  
CEILING RATED  
HOUSINGS**

**HIGH EFFICACY LED  
WITH INTEGRAL  
DRIVER - DIMMABLE**



**ML5606927**  
5" or 6" LED 600 Series



**ML5606930**  
5" or 6" LED 600 Series



**ML5606D2W930**  
5" or 6" LED 600 Series,  
dim-to-warm



**ML5606935**  
5" or 6" LED 600 Series



**ML5606940**  
5" or 6" LED 600 Series

## Compliance

- cULus listed 1598 Luminaire (Halo housings)
- UL Classified when used in retrofit (refer to housing section)
- cULus listed for damp locations
- cULus Wet location listed with baffle and reflector trims only
- Airtight certified per ASTM E283 (not exceeding 2.0 CFM under 57 Pascals pressure difference)
- IP66 ingress protection rated with baffle and reflector trims only
- RoHS compliant
- May be used in IC (insulated ceiling) housings in direct contact with insulation\* and combustible material
- Can be used for California Title 24 compliance / Title 20 certified
- Can be used for International Energy Conservation Code (IECC) high efficiency luminaire compliance.
- Can be used for Washington State Energy Code compliance
- ENERGY STAR® certified luminaire - consult ENERGY STAR® Certified product list
- EMI/RFI per FCC 47CFR Part 15 Class B Consumer limits (commercial and residential compliant)
- Photometric testing in accordance with IES LM-79
- Lumen maintenance projections in accordance with IES LM-80 and TM-21
- CE Mark - "Conformité Européene" conformity with the Council of European Communities Directives, meeting internationally recognized compliance when used with Halo H550, H750, and H2750 Series LED housings only

\* Not for use with housings in direct contact with spray foam insulation.

## Energy Data

### ML56 600/90 Series

(Values at non-dimming line voltage)
Minimum Starting Temp: -30°C (-22°F)
EMI/RFI: FCC Title 47 CFR, Part 15, (Consumer)
Sound Rating: Class A
Input Voltage: UNV 120V-277V
Power Factor: >0.95 @ 120V and >0.9 @277V
Input Frequency: 50/60Hz
THD: <20%
Max. Rated Wattage: 11W
Input Power: 10.2W
Input Current at 120V: 0.15A
Input Current at 277V: 0.08A
Driver Compliance: UL8750, Class II rated
Maximum IC (Insulated Ceiling) Ambient Continuous Operating Temperature: 25°C (77°F)
Maximum Non-IC Ambient Continuous Operating Temperature: 40°C (104°F)



Refer to ENERGY STAR® Certified Products List.  
 Can be used to comply with California Title 24 High Efficacy requirements.  
 Certified to California Title 20 Appliance Efficiency Database.



## Dimensions

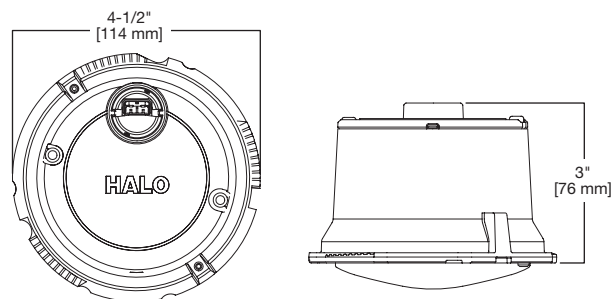

## Ordering Information

Sample Number: **ML5606930 593WB**

Order LED Module and trim separately.

A complete system also includes a compatible housing (new construction, remodel, or existing retrofit). Housing aperture size in the ML56 System is determined by the ML56 trim dimensions. ML56 trims are available in 5" and 6" aperture (5" = 59xx series and 6" = 69xx series trims). Refer to Housing Section in this document.

### ML56 LED Modules 600 Series / 90 CRI

**ML5606927**= 5"/6" LED module, 600 lumen, 90CRI, 2700K  
**ML5606930**= 5"/6" LED module, 600 lumen, 90CRI, 3000K  
**ML5606935**= 5"/6" LED module, 600 lumen, 90CRI, 3500K  
**ML5606940**= 5"/6" LED module, 600 lumen, 90CRI, 4000K  
**ML5606D2W930**= 5"/6" dim-to-warm LED module, 600 lumen, 90CRI, 3000K to 1850K

### ML56 LED 5" and 6" Trims

#### 590 Series - 5" LED Trims

**591WB**=5" LED trim, polymer "dead-front", shallow white baffle & flange – shallow and standard housings (For use with 600 Series LED light modules only)  
**592SC**=5" LED trim, specular reflector & white flange  
**592H**=5" LED trim, haze reflector & white flange  
**592W**=5" LED trim, white reflector & flange  
**593WB**=5" LED trim, white micro-step baffle & flange  
**593BB**=5" LED trim, black micro-step baffle & white flange  
**593SNB**=5" LED trim, satin nickel micro-step baffle & flange  
**593TBZB**=5" LED trim, tuscan bronze micro-step baffle & flange  
**594WB**=5" LED directional trim, white eyeball, baffle & flange – shallow and standard housings  
**594SNB**=5" LED directional trim, satin nickel eyeball, baffle & flange – shallow and standard housings  
**594TBZB**=5" LED directional trim, tuscan bronze eyeball, baffle & flange – shallow and standard housings  
**595WW**=5" LED trim, wall wash - specular reflector, repositionable specular kick reflector, white flange  
**596WB**=5" LED trim, white shallow baffle & flange – shallow and standard housings

#### 690 Series - 6" LED Trims

**691WB**=6" LED trim, polymer "dead-front", white shallow baffle & flange – shallow and standard housings (For use with 600 Series LED light modules only)  
**692SC**=6" LED trim, specular reflector & white flange  
**692H**=6" LED trim, haze reflector & white flange  
**692W**=6" LED trim, white reflector & flange  
**693WB**=6" LED trim, white micro-step baffle & flange  
**693BB**=6" LED trim, black micro-step baffle & white flange  
**693SNB**=6" LED trim, satin nickel micro-step baffle & flange  
**693TBZB**=6" LED trim, tuscan bronze micro-step baffle & flange  
**694WB**=6" LED directional trim, white eyeball, baffle & flange – shallow and standard housings  
**694SNB**=6" LED directional trim, satin nickel eyeball, baffle & flange – shallow and standard housings  
**694TBZB**=6" LED directional trim, tuscan bronze eyeball, baffle & flange – shallow and standard housings  
**695WW**=6" LED trim, wall wash - specular reflector, repositionable specular kick reflector, white flange  
**696WB**=6" LED trim, white shallow baffle & flange – for use with shallow and standard housings

### ML56 System Accessories

**ML56CLIP**=Friction clip mounting kit - For retrofitting non-torsion spring housings, 6" clips\*  
**WW595SC**=5" Wall wash insert - kick reflector for 595WW (1-included with trim) double or corner wall wash\*\*  
**WW695SC**=6" Wall wash insert - kick reflector for 695WW (1-included with trim) double or corner wall wash\*\*  
**TRM590WH**=5" LED oversize trim ring for use with 59" series trims, white 6.3" I.D., 7.5" O.D. Ring slips over LED trim. Inset design allows 5" trim to fit into oversize ring for an even trim surface  
**TRM690WH**=6" LED oversize trim ring for use with 69" series trims, white 6.9" I.D., 9.5" O.D. Ring slips over LED trim. Inset design allows 6" trim to fit into oversize ring for an even trim surface

\*ML56CLIP is compatible with 6" baffle and reflector trims only (691, 692, 693, 695, 696 series). For eyeball trim (694 series) use ML7RAB retrofit adapter band.

\*\*Wall wash trims 595WW and 695WW Feature an exclusive repositionable kick reflector for fine-tuning adjustment of the wall wash effect. The WW595SC and WW695SC are repositionable kick reflectors sold separately for addition to the wall wash trim when a double or corner wall wash is needed, or for replacement of original kick reflector included with the trim.

## Lighting Facts

### ML5606927

PRODUCT SPECIFICATIONS	
Lumens (Light Output)	<b>596</b>
Watts	<b>10.2</b>
Lumens Per Watt (Efficacy)	<b>57.1</b>
Color Accuracy (CRI)	<b>92</b>
Light Color (CCT)	<b>2700K</b>
Correlated Color Temperature (CCT)	
MODEL# ML5606927	

### ML5606930

PRODUCT SPECIFICATIONS	
Lumens (Light Output)	<b>655</b>
Watts	<b>10.2</b>
Lumens Per Watt (Efficacy)	<b>59.4</b>
Color Accuracy (CRI)	<b>94</b>
Light Color (CCT)	<b>3000K</b>
Correlated Color Temperature (CCT)	
MODEL# ML5606930	

### ML5606D2W930

PRODUCT SPECIFICATIONS	
Lumens (Light Output)	<b>655</b>
Watts	<b>10.2</b>
Lumens Per Watt (Efficacy)	<b>59.4</b>
Color Accuracy (CRI)	<b>94</b>
Light Color (CCT)	<b>3000K</b>
Correlated Color Temperature (CCT)	
MODEL# ML5606930	

### ML5606935

PRODUCT SPECIFICATIONS	
Lumens (Light Output)	<b>672</b>
Watts	<b>10.2</b>
Lumens Per Watt (Efficacy)	<b>65.9</b>
Color Accuracy (CRI)	<b>94</b>
Light Color (CCT)	<b>3500K</b>
Correlated Color Temperature (CCT)	
MODEL# ML5606935	

### ML5606940

PRODUCT SPECIFICATIONS	
Lumens (Light Output)	<b>709</b>
Watts	<b>10.2</b>
Lumens Per Watt (Efficacy)	<b>69.5</b>
Color Accuracy (CRI)	<b>93</b>
Light Color (CCT)	<b>4000K</b>
Correlated Color Temperature (CCT)	
MODEL# ML5606940	

## Housing – Trim Compatibility

Housing compatibility in the ML56 System is determined by the ML56 trim dimensions. ML56 trims are available in 5" and 6" aperture (5" = 59xx series and 6" = 69xx series trims). Refer to ML56 TRIMS in this document. (Note "X" in the trim model number denotes finish code.)

## Housing – Compatibility

The ML56 LED module - trim combination is cULus Listed or UL Classified for use with any 5" or 6" diameter recessed housing constructed of steel or aluminum with an internal volume that exceeds 115 in<sup>3</sup> in addition to those noted below.

## Halo UL Listed Compatibility

**6" Trims: 691X, 692X, 693X, 694X, 695X, 696X**

(Note shallow housings for use with 691X, 694X, 696X trims only)

## HALO - LED Housings with LED Luminaire Connector - High-Efficacy Compliant

Brand	Housing Type	Catalog Number	Description
Halo	Standard Housings	H750ICAT	6" LED, Insulated Ceiling, Air-Tite, New Construction Housing
		H750RICAT	6" LED, Insulated Ceiling, Air-Tite, Remodel Housing
		H750T	6" LED, Non-IC, Air-Tite, New Construction Housing
		H750TCP	6" LED, Non-IC, New Construction/Remodel Chicago Plenum Housing
Halo	Shallow Housings	H2750ICAT	6" LED, Shallow, Insulated Ceiling, Air-Tite, New Constr. (use with 691X, 694X, 696X trims only)
		H2750RICAT	6" LED, Shallow, Insulated Ceiling, Air-Tite, Remodel (use with 691X, 694X, 696X trims only)

## HALO - Incandescent E26 Screwbase Housings

Brand	Housing Type	Catalog Number	Description
Halo	Standard Housings	H7ICAT	6" Insulated Ceiling, Air-Tite New Construction Housing
		H7RICAT	6" Insulated Ceiling, Air-Tite Remodel Housing
		H7ICT	6" Insulated Ceiling, New Construction Housing
		H7RICT	6" Insulated Ceiling, Remodel Housing
		H7ICATNB	6" Insulated Ceiling, Air-Tite New Construction Housing, No Socket Bracket
		H7ICTNB	6" Insulated Ceiling, New Construction Housing, No Socket Bracket
		H7T	6" Non-IC, New Construction Housing
		H7RT	6" Non-IC, Remodel Housing
		H7TNB	6" Non-IC, New Construction Housing, No Socket Bracket
		H7TCP	6" Non-IC, Chicago Plenum, New Construction/Remodel Housing
		H7UICAT	6" Insulated Ceiling, Universal, Air-Tite, New Construction Housing
		E7ICAT	6" IC, Air-Tite, New Construction Housing, 120V
		E7ICATNB	6" IC, AIRTITE, New Construction, No Socket Bracket Housing, 120V
		E7TAT	6" Non-IC, Air-Tite, New Construction Housing, 120V
		E7TATNB	6" Non-IC, Air-Tite, New Construction, No Socket Bracket Housing, 120V
		E27ICAT	6" IC, Air-Tite, Shallow New Construction Housing, 120V
		E27TAT	6" Non-IC, Air-Tite, Shallow New Construction Housing, 120V
		E7RICAT	6" IC, Air-Tite, Remodel Housing, 120V
		E7RTAT	6" Non-IC, Air-Tite, Remodel Housing, 120V
		Halo	Shallow Housings
H27RICAT	6" Shallow, Insulated Ceiling, Air-Tite Remodel Housing (use with 691X, 694X, 696X trims only)		
H27ICT	6" Shallow, Insulated Ceiling, New Construction Housing (use with 691X, 694X, 696X trims only)		
H27RICT	6" Shallow, Insulated Ceiling, Remodel Housing (use with 691X, 694X, 696X trims only)		
H27T	6" Shallow, Non-IC, New Construction Housing (use with 691X, 694X, 696X trims only)		
H27RT	6" Shallow, Non-IC, Remodel Housing (use with 691X, 694X, 696X trims only)		
E27RICAT	6" IC, Air-Tite, Shallow Remodel Housing, 120V		
E27RTAT	6" Non-IC, Air-Tite, Shallow Remodel Housing, 120V		

## Halo LED Retrofit Enclosures

Brand	Type	Catalog Number	Description
Halo	Retrofit	ML7BXRFK	6" Retrofit Enclosure, Non-IC, BX Whip
		ML7E26RFK	6" Retrofit Enclosure, Non-IC, E26 Screw base Interface

## Housing Compatibility

5" Trims: 591X, 592X, 593X, 594X, 595X, 596X

(Note shallow housings for use with 591X, 594X, 596X trims only)

### HALO - LED Housings with LED Luminaire Connector - High-Efficacy Compliant

Brand	Housing Type	Catalog Number	Description
Halo	Standard Housings	H550ICAT	5" LED, Insulated Ceiling, Air-Tite, New Construction Housing
		H550RICAT	5" LED, Insulated Ceiling, Air-Tite, Remodel Housing

### HALO - Incandescent E26 Screwbase Housings

Brand	Housing Type	Catalog Number	Description		
Halo	Standard Housings	H5ICAT	5" Insulated Ceiling, Air-Tite New Construction Housing		
		H5RICAT	5" Insulated Ceiling, Air-Tite Remodel Housing		
		H5ICATNB	5" IC, Air-Tite New Construction, No Socket Bracket Housing, 120V		
		H5T	5" Non-IC, New Construction Housing		
		H5RT	5" Non-IC, Remodel Housing		
		H5TNB	5" Non-IC, New Construction, No Socket Bracket Housing, 120V		
		E5ICAT	5" IC, Air-Tite, New Construction Housing, 120V		
		E5ICATNB	5" IC, Air-Tite, New Construction, No Socket Bracket Housing, 120V		
		E5TAT	5" Non-IC, Air-Tite, New Construction Housing, 120V		
		E5TATNB	5" Non-IC, Air-Tite, New Construction, No Socket Bracket Housing, 120V		
		E5RICAT	5" IC, Air-Tite, Remodel Housing, 120V		
		E5RTAT	5" Non-IC, Air-Tite, Remodel Housing, 120V		
		Halo	Shallow Housings	H25ICAT	5" Shallow, Insulated Ceiling, Air-Tite New Construction (use with 591X, 594X, 596X trims only)
				H25ICATNB	5" IC, Air-Tite Shallow, New Const., No Socket Bracket Housing, 120V

### Housings - UL Classified for Retrofit Compatibility

6" Trims: 691X, 692X, 693X, 694X, 695X, 696X

(Note shallow housings for use with 691X, 694X, 696X trims only)

Brand	Housing Type	Catalog Number
Juno	Standard Housings	IC22, IC22R, IC22W, IC22S, IC23, IC23W, TC2, TC2R, IC2
	Shallow Housing	IC21, IC21R (use with 691X, 694X, 696X trims only)
Capri	Standard Housings	CR1, PR1, QL1
	Shallow Housing	R9ASIC/PS9RM (use with 691X, 694X, 696X trims only)
Elco		HL7ICA (EL7ICA)
Lithonia	Standard Housings	LC6, L7X
	Shallow Housing	L7XP (use with 691X, 694X, 696X trims only)
Thomas		PS1
Commercial Electric		C7ICA, H3
Progress	Standard Housings	P87-AT † *
	Shallow Housing	P86TG (use with 691X, 694X, 696X trims only)
Lightolier		1104ICS †*, 1104ICR †*

† Requires replacement of torsion springs with Friction Clips. Order Friction Clip Kit separately: ML56CLIP

\* ML56CLIP is compatible with only baffle and reflector trims

5" Trims: 591X, 596X

Brand	Housing Type	Catalog Number
Juno	Standard Housings	IC20, IC25S, IC25W, TC20

**ML56 600 Series Compliance Table**

90 CRI LED Modules with ML56 Trims

	ML5606927	ML5606930	ML5606D2W930	ML5606935	ML5606940
593BB	IECC	IECC	IECC	IECC	T24, IECC
693BB	IECC	T24, IECC	T24, IECC	T24, IECC	T24, IECC
593TBZB	IECC	T24, IECC	T24, IECC	T24, IECC	T24, IECC
693TBZB	IECC	T24, IECC	T24, IECC	T24, IECC	T24, IECC
593SNB	T24, IECC	T24, IECC	T24, IECC	T24, IECC	T24, IECC
693SNB	T24, IECC	T24, IECC	T24, IECC	T24, IECC	ES,T24, IECC
592H	T24, IECC	ES,T24, IECC	ES,T24, IECC	ES,T24, IECC	ES,T24, IECC
592W	T24, IECC	ES,T24, IECC	ES,T24, IECC	ES,T24, IECC	ES,T24, IECC
593WB	T24, IECC	ES,T24, IECC	ES,T24, IECC	ES,T24, IECC	ES,T24, IECC
592SC	ES,T24, IECC	ES,T24, IECC	ES,T24, IECC	ES,T24, IECC	ES,T24, IECC
692H	ES,T24, IECC	ES,T24, IECC	ES,T24, IECC	ES,T24, IECC	ES,T24, IECC
595WW	ES,T24, IECC	ES,T24, IECC	ES,T24, IECC	ES,T24, IECC	ES,T24, IECC
695WW	ES,T24, IECC	ES,T24, IECC	ES,T24, IECC	ES,T24, IECC	ES,T24, IECC
693WB	ES,T24, IECC	ES,T24, IECC	ES,T24, IECC	ES,T24, IECC	ES,T24, IECC
692SC	ES,T24, IECC	ES,T24, IECC	ES,T24, IECC	ES,T24, IECC	ES,T24, IECC
692W	ES,T24, IECC	ES,T24, IECC	ES,T24, IECC	ES,T24, IECC	ES,T24, IECC
596WB	ES,T24, IECC	ES,T24, IECC	ES,T24, IECC	ES,T24, IECC	ES,T24, IECC
694TBZB	ES,T24, IECC	ES,T24, IECC	ES,T24, IECC	ES,T24, IECC	ES,T24, IECC
594TBZB	ES,T24, IECC	ES,T24, IECC	ES,T24, IECC	ES,T24, IECC	ES,T24, IECC
696WB	ES,T24, IECC	ES,T24, IECC	ES,T24, IECC	ES,T24, IECC	ES,T24, IECC
694SNB	ES,T24, IECC	ES,T24, IECC	ES,T24, IECC	ES,T24, IECC	ES,T24, IECC
594SNB	ES,T24, IECC	ES,T24, IECC	ES,T24, IECC	ES,T24, IECC	ES,T24, IECC
694WB	ES,T24, IECC	ES,T24, IECC	ES,T24, IECC	ES,T24, IECC	ES,T24, IECC
594WB	ES,T24, IECC	ES,T24, IECC	ES,T24, IECC	ES,T24, IECC	ES,T24, IECC
594WB-30	ES,T24, IECC	ES,T24, IECC	ES,T24, IECC	ES,T24, IECC	ES,T24, IECC
694WB-30	ES,T24, IECC	ES,T24, IECC	ES,T24, IECC	ES,T24, IECC	ES,T24, IECC

**Code Descriptions:**

ES = ENERGY STAR® Certified Luminaire

T24 = Can be used to comply with California Title 24 High Efficacy requirements. Certified to California Title 20 Appliance Efficiency Database.

IECC = International Energy Conservation Code "High Efficacy"

**ML56 600 Series Lumen Table**

90 CRI LED Modules with ML56 trims

	Trim Catalog #	ML5606927		ML5606930		ML5606D2W930		ML5606935		ML5606940	
		Lumens	LPW	Lumens	LPW	Lumens	LPW	Lumens	LPW	Lumens	LPW
0° Tilt Angle	593BB	393.0	38.5	431.9	42.3	480.7	50.3	443.1	43.4	467.5	45.8
	693BB	435.0	42.6	478.1	46.9	532.1	55.7	490.5	48.1	517.5	50.7
	593TBZB	441.0	43.2	484.7	47.5	539.4	56.4	497.2	48.7	524.6	51.4
	693TBZB	457.0	44.8	502.2	49.2	559.0	58.5	515.3	50.5	543.6	53.3
	593SNB	489.0	47.9	537.4	52.7	598.2	62.6	551.4	54.1	581.7	57.0
	693SNB	505.0	49.5	555.0	54.4	617.7	64.6	569.4	55.8	600.7	58.9
	592H	551.0	54.0	605.5	59.4	674.0	70.5	621.3	60.9	655.5	64.3
	592W	568.0	55.7	624.2	61.2	694.8	72.7	640.4	62.8	675.7	66.2
	593WB	578.0	56.7	635.2	62.3	707.0	74.0	651.7	63.9	687.6	67.4
	592SC	582.0	57.1	639.6	62.7	711.9	74.5	656.2	64.3	692.3	67.9
	692H	584.0	57.3	641.8	62.9	714.4	74.7	658.5	64.6	694.7	68.1
	595WW	586.0	57.5	644.0	63.1	716.8	75.0	660.7	64.8	697.1	68.3
	695WW	587.0	57.5	645.1	63.2	718.0	75.1	661.9	64.9	698.3	68.5
	693WB	596.0	58.4	655.0	64.2	729.0	76.3	672.0	65.9	709.0	69.5
	692SC	596.0	58.4	655.0	64.2	729.0	76.3	672.0	65.9	709.0	69.5
	692W	598.0	58.6	657.2	64.4	731.5	76.5	674.3	66.1	711.4	69.7
	596WB	609.0	59.7	669.3	65.6	744.9	77.9	686.7	67.3	724.5	71.0
	694TBZB	614.0	60.2	674.8	66.2	751.1	78.6	692.3	67.9	730.4	71.6
	594TBZB	615.0	60.3	675.9	66.3	752.3	78.7	693.4	68.0	731.6	71.7
	696WB	619.0	60.7	680.3	66.7	757.2	79.2	697.9	68.4	736.4	72.2
694SNB	627.0	61.5	689.1	67.6	767.0	80.2	707.0	69.3	745.9	73.1	
594SNB	629.0	61.7	691.3	67.8	769.4	80.5	709.2	69.5	748.3	73.4	
694WB	648.0	63.5	712.1	69.8	792.7	82.9	730.6	71.6	770.9	75.6	
594WB	650.0	63.7	714.3	70.0	795.1	83.2	732.9	71.9	773.2	75.8	
30° Tilt Angle	594WB-30	630.0	70.0	692.4	76.9	770.6	80.6	710.3	78.9	749.4	83.3
	694WB-30	602.0	66.9	661.6	73.5	736.4	77.0	678.8	75.4	716.1	79.6

Photometry 5" Trims • 600 Series • 90 CRI

Multiplier Table

CCT Option	2700 K	3000 K	3500 K	4000 K
CCT Multiplier	0.91	1.00	1.03	1.08

Table based upon testing with 3000°K color temperature, 90CRI.

Multipliers may be used to determine relative lumen values with other color temperatures.

ML5606930-592SC

Test Number	P130232
Light Module	600 Series, 90CRI
Trim	5" Aperture, Specular Clear Trim
Lumens	640
Efficacy	62.7 Lm/W
SC	1.06

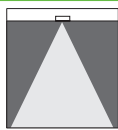

Cone of Light

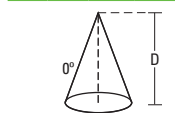

D	FC	L	W
5.5	15.4	5.8	5.8
7	9.5	7.2	7.2
8	7.3	8.4	8.4
9	5.7	9.4	9.4
10	4.6	10.4	10.4
12	3.2	12.6	12.6

Candlepower Distribution

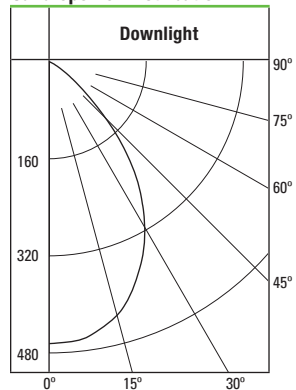

Zonal Lumen Summary

Zone	Lumens	%Fixture
0-30	331	51.7
0-40	493	77
0-60	631	98.7
0-90	640	100
90-180	0	0
0-180	640	100

ML5606930-594WB

Test Number	P130280
Light Module	600 Series, 90CRI
Trim	5" Aperture, Directional Eyeball
Lumens	714
Efficacy	70 Lm/W
SC	1.22

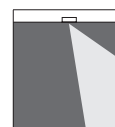

Candlepower Distribution

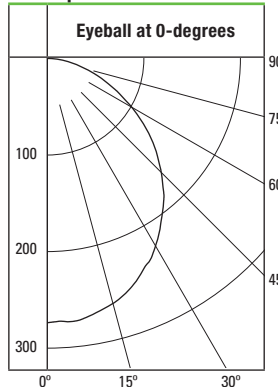

Zonal Lumen Summary

Zone	Lumens	%Fixture
0-30	210	29.4
0-40	339	47.5
0-60	579	81
0-90	714	100
90-180	0	0
0-180	714	100

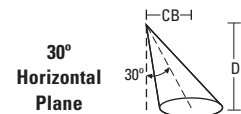

D	FC	L	W	CB
5.5	8	6.6	6.6	3.2
7	4.9	8.3	8.4	4
8	3.8	9.6	9.8	4.6
9	3	10.7	11	5.2
10	2.4	12	12.2	5.8
12	1.7	14.3	14.6	6.9

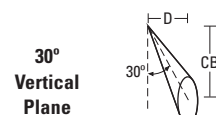

D	FC	L	W	CB
1'	156	1.1	1.2	1.7
2'	39	2.2	2.6	3.5
3'	17.3	3.3	3.8	5.2
4'	9.7	4.5	5.2	6.9
5'	6.2	5.6	6.6	8.7
6'	4.3	6.7	7.8	10.4

Candlepower Distribution

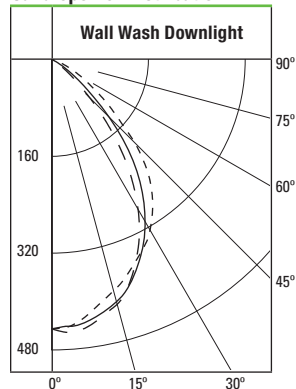

ML5606930-595WW

Test Number	P130304
Light Module	600 Series, 90CRI
Trim	5" Aperture, Wall Wash with Specular Clear Trim and Specular Clear Kick Reflector
Lumens	644
Efficacy	63.1 Lm/W
SC	1.06

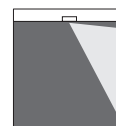

Zonal Lumen Summary

Zone	Lumens	%Fixture
0-30	316	49
0-40	475	73.8
0-60	627	97.3
0-90	644	100
90-180	0	0
0-180	644	100

Single Unit Footcandles

2.5' From Wall (Distance From Fixture Along Wall)

DD	●	1'	2'	3'	4'	5'	6'
1'	2.7	1.7	0.7	0.2	0.1	0	0
2'	9.2	6.6	2.9	0.9	0.3	0.1	0
3'	10.5	8.7	4.7	1.9	0.7	0.2	0.1
4'	7.4	6.6	4.8	2.6	1.1	0.5	0.2
5'	4.9	4.6	3.7	2.5	1.4	0.7	0.3
6'	3.3	3.1	2.7	2	1.4	0.8	0.4
7'	2.3	2.2	2	1.6	1.2	0.8	0.5
8'	1.6	1.6	1.5	1.2	1	0.7	0.5
9'	1.2	1.2	1.1	1	0.8	0.6	0.5
10'	0.9	0.9	0.8	0.7	0.6	0.5	0.4

Multiple Unit Footcandles

2.5' From Wall (Distance From Fixture Along Wall)

DD	--3'--	--4'--
1'	2.9 2.3 2.9	2.8 1.3 2.8
2'	10.1 9.3 10.1	9.5 5.8 9.5
3'	12.5 13.7 12.5	11.3 9.5 11.3
4'	10.1 11.7 10.1	8.6 9.5 8.6
5'	7.4 8.4 7.4	6.4 7.3 6.4
6'	5.3 5.9 5.3	4.7 5.4 4.7
7'	3.9 4.2 3.9	3.5 3.9 3.5
8'	2.9 3.1 2.9	2.6 2.9 2.6
9'	2.2 2.3 2.2	2 2.2 2
10'	1.7 1.8 1.7	1.6 1.7 1.6

Legend

0-deg:	---	Wall
90-deg:	---	Side
180-deg:	---	Room

Photometric tests are per IES measurement standards. Tests represent typical fixture performance. Field results may vary.

Photometry 6" Trims • 600 Series • 90 CRI

Multiplier Table

CCT Option	2700 K	3000 K	3500 K	4000 K
CCT Multiplier	0.91	1.00	1.03	1.08

Table based upon testing with 3000°K color temperature, 90CRI.

Multipliers may be used to determine relative lumen values with other color temperatures.

ML5606930-692SC

Test Number	P130320
Light Module	600 Series, 90CRI
Trim	6" Aperture, Specular Clear Trim
Lumens	655
Efficacy	64.2 Lm/W
SC	0.66



Cone of Light

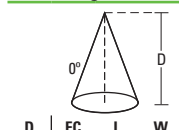

D	FC	L	W
5.5	25.4	3.6	3.6
7	15.7	4.6	4.6
8	12	5.2	5.2
9	9.5	5.8	5.8
10	7.7	6.6	6.6
12	5.3	7.8	7.8

Candlepower Distribution

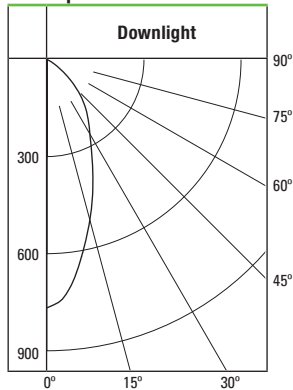

Zonal Lumen Summary

Zone	Lumens	%Fixture
0-30	361	55.1
0-40	499	76.3
0-60	647	98.7
0-90	655	100
90-180	0	0
0-180	655	100

ML5606930-694WB

Test Number	P130376
Light Module	600 Series, 90CRI
Trim	6" Aperture, Directional Eyeball
Lumens	712
Efficacy	69.8 Lm/W
SC	1.21

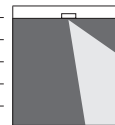

Candlepower Distribution

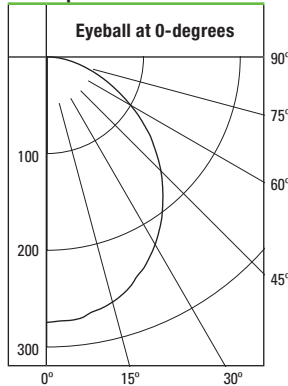

Zonal Lumen Summary

Zone	Lumens	%Fixture
0-30	210	29.5
0-40	339	47.6
0-60	577	81.1
0-90	712	100
90-180	0	0
0-180	712	100

30° Horizontal Plane

D	FC	L	W	CB
5.5	8	6.5	6.6	3.2
7	4.9	8.3	8.6	4
8	3.8	9.6	9.8	4.6
9	3	10.7	11	5.2
10	2.4	11.9	12.2	5.8
12	1.7	14.3	14.6	6.9

30° Vertical Plane

D	FC	L	W	CB
1'	155	1.1	1.2	1.7
2'	38.8	2.2	2.6	3.5
3'	17.2	3.3	3.8	5.2
4'	9.7	4.5	5.2	6.9
5'	6.2	5.6	6.6	8.7
6'	4.3	6.7	7.8	10.4

Candlepower Distribution

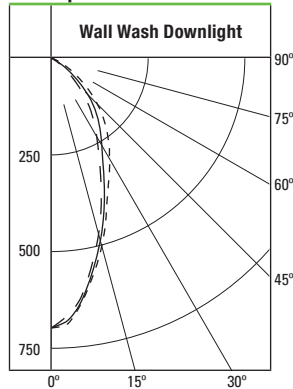

ML5606930-695WW

Test Number	P130400
Light Module	600 Series, 90CRI
Trim	6" Aperture, Wall Wash with Specular Clear Trim and Specular Clear Kick Reflector
Lumens	645
Efficacy	63.2 Lm/W
SC	0.69

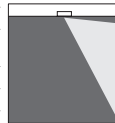

Zonal Lumen Summary

Zone	Lumens	%Fixture
0-30	345	53.5
0-40	482	74.7
0-60	630	97.7
0-90	645	100
90-180	0	0
0-180	645	100

Single Unit Footcandles

2.5' From Wall (Distance From Fixture Along Wall)

DD	●	1'	2'	3'	4'	5'	6'
1'	1.9	1.1	0.4	0.1	0	0	0
2'	8.5	6.1	2.6	0.8	0.2	0.1	0
3'	9	7.4	4.3	1.9	0.7	0.2	0.1
4'	6.7	5.8	4	2.3	1.1	0.5	0.2
5'	4.8	4.3	3.2	2.1	1.3	0.7	0.3
6'	3.4	3.1	2.5	1.8	1.2	0.8	0.4
7'	2.6	2.3	1.9	1.4	1	0.7	0.5
8'	2	1.8	1.5	1.2	0.9	0.6	0.5
9'	1.5	1.4	1.2	1	0.7	0.5	0.4
10'	1.2	1.1	1	0.8	0.6	0.5	0.4

Multiple Unit Footcandles

2.5' From Wall (Distance From Fixture Along Wall)

DD	--3'--	--4'--
1'	2 1.4 2	1.9 0.9 1.9
2'	9.3 8.4 9.3	8.7 5.2 8.7
3'	10.9 11.7 10.9	9.7 8.6 9.7
4'	9.1 9.9 9.1	7.9 8.1 7.9
5'	6.9 7.5 6.9	6.1 6.4 6.1
6'	5.2 5.6 5.2	4.6 4.9 4.6
7'	4 4.3 4	3.6 3.8 3.6
8'	3.1 3.3 3.1	2.8 3 2.8
9'	2.5 2.6 2.5	2.2 2.4 2.2
10'	2 2.1 2	1.8 1.9 1.8

Legend

0-deg:	---	Wall
90-deg:	---	Side
180-deg:	---	Room

Photometric tests are per IES measurement standards. Tests represent typical fixture performance. Field results may vary.