

Maestro® Occupancy sensing switch

To power the sensing circuit, occupancy sensing switches require a small flow of current when the load is in the OFF state. This can be accomplished by connecting the power supply return wire to ground or to neutral.

Local codes in certain municipalities require that a neutral conductor be run to the switch box, regardless of construction. In one particular instance, installing occupancy sensors that use the ground wire to function is not permitted.

The MS-OPS6M2U-DV and MS-VPS6M2U products allow the installer to configure the device to connect to either ground or neutral.

- To connect to ground, simply install the product in its "out-of-the box" condition.
- To connect to neutral, install the supplied white sleeve over the green wire.

For more information about occupancy sensing switches and the National Electrical code, see:

www.lutron.com/TechnicalDocumentLibrary/048469.pdf

Features

- Passive infrared sensors with exclusive Lutron® XCT™ Technology for fine motion detection
- 180° sensor field-of-view
- Up to 30 ft x 30 ft (9 m x 9 m) [900 ft² (81 m²)] major motion coverage and 20 ft x 20 ft (6 m x 6 m) [400 ft² (36 m²)] minor motion coverage
- Occupancy version can be set to Auto-ON/Auto-OFF or Manual-ON/Auto-OFF
- Vacancy version available to meet CA Title 24 requirements
- Adjustable timeout (1, 5, 15, or 30 minutes) and high/low sensitivity adjustment
- Occupancy sensing switch loads: incandescent, halogen, ELV, MLV, CFL, LED, magnetic fluorescent, electronic fluorescent, and fan.

Models available

MS-OPS6M2U-DV

MS-VPS6M2U-DV

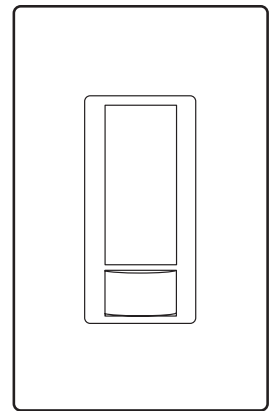

MS-OPS6M2U-DV
MS-VPS6M2U-DV

Job Name:	Model Numbers:
Job Number:	

Specifications

Regulatory Approvals

- UL® Listed to U.S. and Canadian safety requirements.
- NOM Certification (pending).

Power

- 120–277 V~ 50/60 Hz¹

Key Design Features

- All lighting loads.
- Crush/tamper resistant lens.
- Smart ambient light detection.
- Adaptive switching algorithm for extended relay life.
- XCT™ Technology for fine motion detection.

Environment

- Ambient operating temperature: 32 °F to 104 °F (0 °C to 40 °C), 0%–90% humidity, non-condensing. Indoor use only.

Warranty

- 5-Year Limited Warranty. For additional Warranty information, please visit www.lutron.com/TechnicalDocumentLibrary/Sensor_Warranty.pdf

Additional Information

- For Maestro® Occupancy sensing dimmer models, please see [Lutron® P/N 369270](#).
- For other Maestro® Occupancy sensing switch models, please see [Lutron® P/N 369666](#).
- For use with MA-AS, MSC-AS, MA-AS-277, or MSC-AS-277 to control the load from more than two locations, please see [Lutron® P/N 048435](#).
- For more information, please see www.lutron.com/occvacsensors
- Lutron Technical Hotline: 1.800.523.9466.

Advanced Features

Switching

Adaptive zero cross feature maximizes relay life by switching at the point of minimum energy on the AC power curve. Actively adapts to variations in relay timing.

XCT™ Technology

Advanced sensing technology for fine motion detection ensures that the lights stay on while the room is occupied, and that the sensor does not turn on falsely when there is no occupancy in the room. For more information, see www.lutron.com/TechnicalDocumentLibrary/white%20paper%20XCT%204-23-09%20B.pdf

¹ Maximum current ratings for individual models are provided in the **Selection Matrix** on page 4.

Job Name:	Model Numbers:
Job Number:	

Custom Settings

Ambient Light Detection

- Lights turn on only if natural light in room is low.
- Smart—Ambient light threshold adjusts precisely to the user's preference.

Instructions: If switch turns on when there is enough natural light, or if switch does not turn on when there is not enough natural light, press the large button within 5 seconds of entering the room. Over time, this interaction will "teach" the switch your preferred setting.

Sensor Operation

- Occupancy/Vacancy: Auto-ON/Auto-OFF or Manual-ON/Auto-OFF
- Vacancy only: Manual-ON/Auto-OFF only

Timeout Options

(See **Additional Features** on page 4 for default settings)

- 1 Minute
- 5 Minutes
- 15 Minutes
- 30 Minutes

Sensitivity Options

- High sensitivity (default)
- Low sensitivity

Auto-ON Options

(MS-OPS only)

- Occupancy (default): Auto-ON/Auto-OFF
- Vacancy*: Manual-ON/Auto-OFF
- Low Light: Lights turn on only if needed (if ambient light is below threshold)

* There is a 15-second grace period that begins when the lights are automatically turned off, during which the lights will automatically turn back on in response to motion. This grace period is provided as a safety and convenience feature in the event that the lights turn off while the room is still occupied, so that the user does not need to manually turn the lights back on. After 15 seconds, the grace period expires and the lights must be manually turned on.

Manual Off-While-Occupied Options

(MS-OPS only — see **Additional Features** on page 4 for default setting)

- Enabled
 - When the Occupancy sensing switch is manually turned off, the Occupancy sensing switch will not turn the lights back on automatically while the room is occupied.
 - Once the room is vacated, the Auto-ON feature returns to normal operation after the timeout period has expired.
 - This may be the preference in conference rooms or classrooms while viewing presentations. This feature requires motion to keep the lights off.
- Disabled
 - When the Occupancy sensing switch is manually turned off, the Auto-ON feature will return to normal operation after 25 seconds.
 - This may be the preference if the user always wants the lights to turn on upon entering and the lights to turn off when the room is vacant.

<p>Job Name:</p> <p>Job Number:</p>	<p>Model Numbers:</p>
--	------------------------------

Selection Matrix

Vacancy only ² (Title 24 compliant)										Single-pole / 3-way capability
Single-pole only										
Works with standard mechanical 3-way switch ³										Max current rating
Works with companion switch ^{3, 4}										
All lighting loads (120 V~ only)										
All lighting loads (120–277 V~ only)										
Fan (120 V~)										
Light + Fan (120 V~)										Off-state power
Neutral or ground wire required for functionality ⁵										
Minimum load required										

Model Number¹

MS-OPS6M2U-DV-XX			✓	✓		6 A	3 A	3 A	✓	
MS-VPS6M2U-DV-XX	✓		✓	✓		6 A	3 A	3 A	✓	

¹ XX in model number represents color/finish code.

² Occupancy sensors can be configured as Auto-ON/Auto-OFF or Manual-ON/Auto-OFF. Vacancy sensors are configured as Manual-ON/Auto-OFF only.

³ Standard mechanical 3-way switch cannot be combined with companion switch.

⁴ Companion switch MA-AS, MSC-AS, MA-AS-277, or MSC-AS-277 is required for multi-location installations (more than two locations controlling the same lighting circuit). Up to nine companion switches may be connected.

⁵ The green wire can be connected to ground or, when covered by the white sleeve, can be connected to neutral (see illustrations on page 7).

Additional Features

Crush/tamper-resistant lens						
Ambient light detection						
Switching						
XCT™ technology						
Manual off-while-occupied default setting						
Default timeout (minutes)						

Model Number¹

MS-OPS6M2U-DV-XX	✓	Smart	Adaptive	✓	Enabled	15
MS-VPS6M2U-DV-XX	✓	Smart	Adaptive	✓		15

¹ XX in model number represents color/finish code.

Job Name:	Model Numbers:
Job Number:	

Occupancy Sensing Switch Placement and Operation

- The ability of the Occupancy sensing switch to detect motion requires line-of-sight of room occupants. The Occupancy sensing switch must have an unobstructed view of the room.
- Hot objects and moving air currents can affect the performance of the Occupancy sensing switch.
- The performance of the Occupancy sensing switch depends on a temperature differential between the ambient room temperature and that of room occupants. Warmer rooms may reduce the ability of the Occupancy sensing switch to detect occupants.

Definitions

Major motion: movement of a person entering or passing through an area.

Minor motion: movement of a person occupying an area and engaging in small activities (e.g., reaching for a telephone, turning the pages of a book, opening a file folder, picking up a coffee cup).

NEMA WD7 Coverage

 Major motion coverage: 900 ft² (81 m²)

 Minor motion coverage: 400 ft² (36 m²)

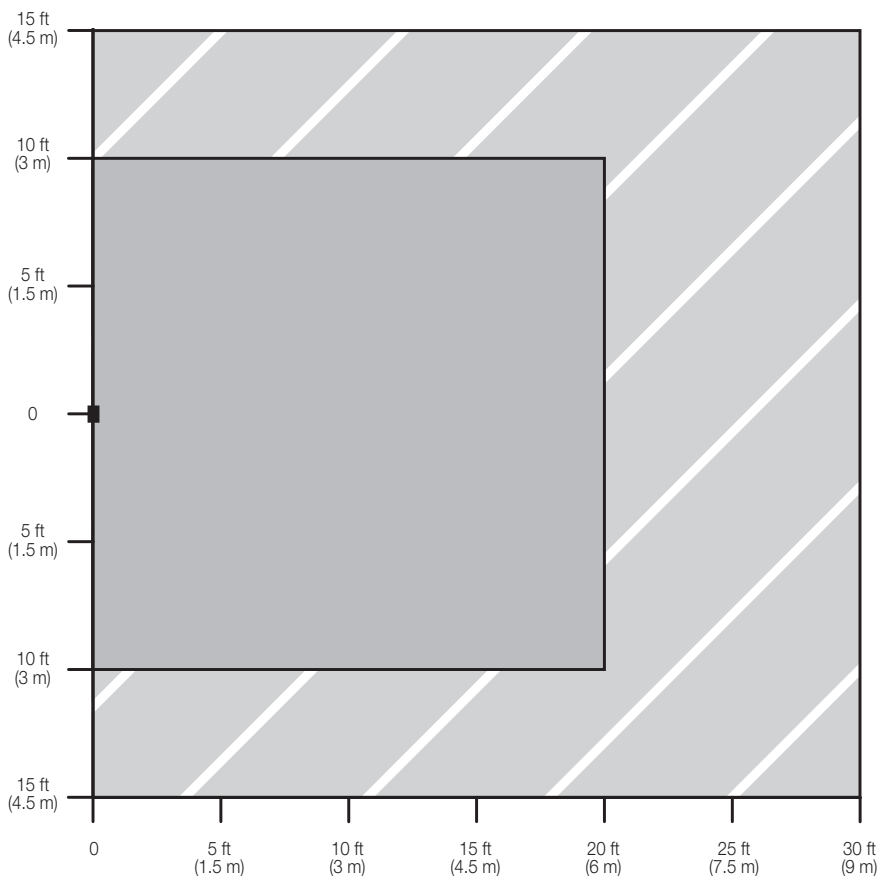

Horizontal Beam Diagram

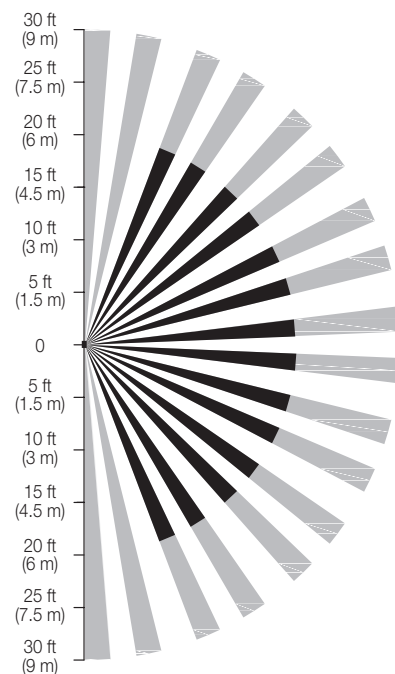

Vertical Beam Diagram

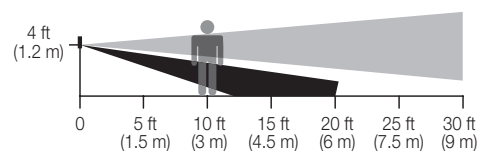

Job Name:	Model Numbers:
Job Number:	

Dimensions

Measurements shown as: in (mm).

Front View

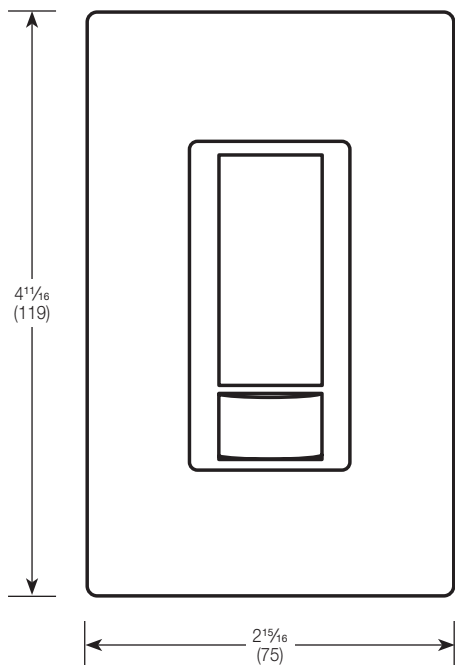

Side View

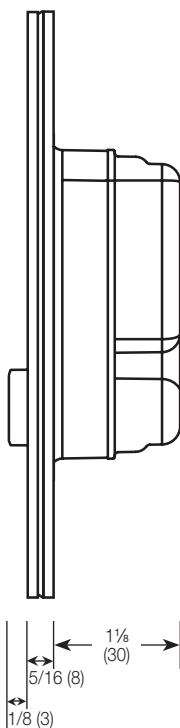

Mounting

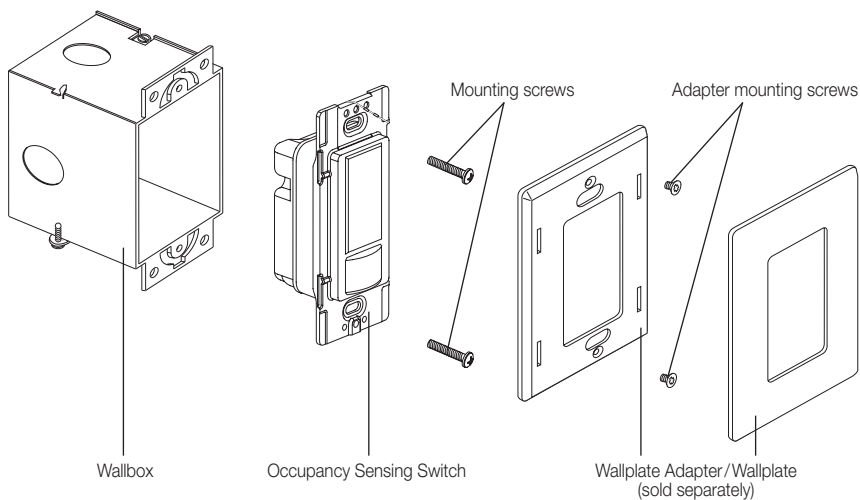

Operation

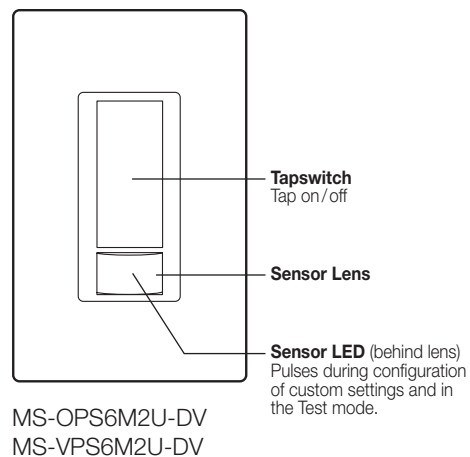

Job Name:	Model Numbers:
Job Number:	

Converting Ground Wire to Neutral Wire

The green wire can be connected to ground or, when covered by the white sleeve, can be connected to neutral.

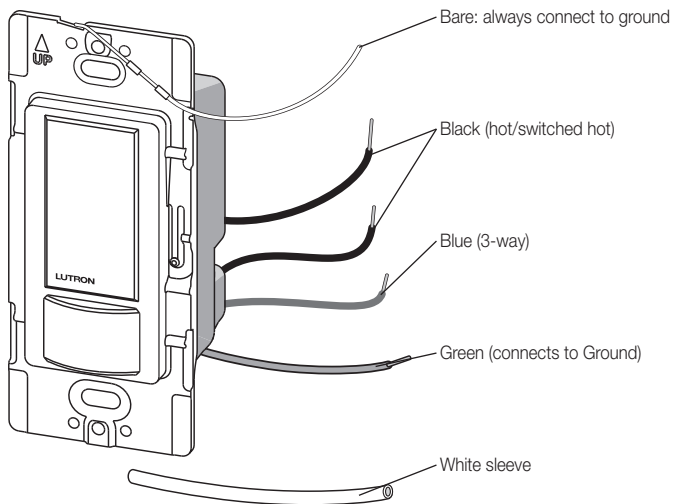

Slide white sleeve over green wire until flush with back cover.

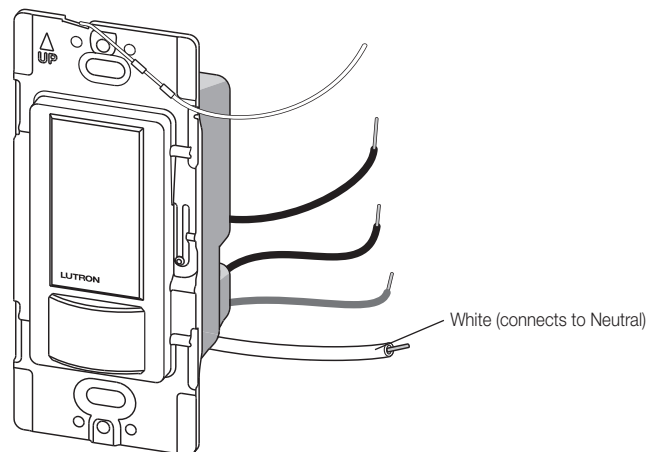
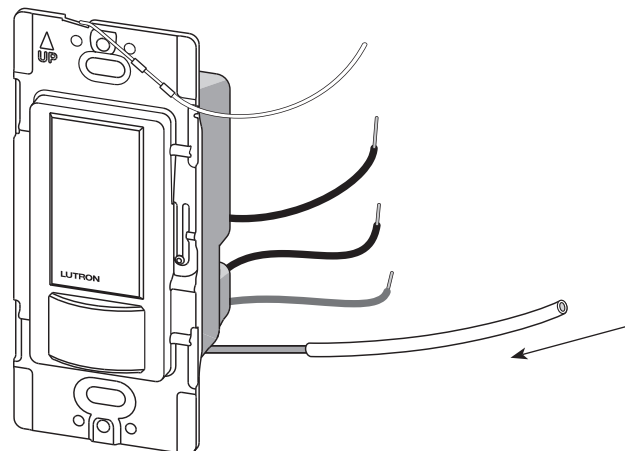
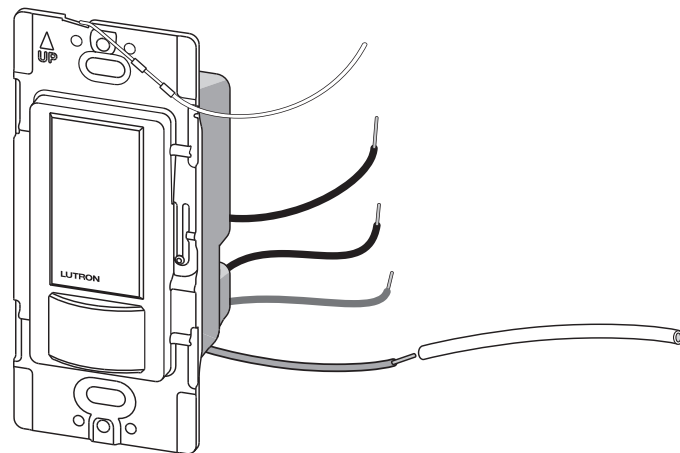

Job Name:	Model Numbers:
Job Number:	

Wiring Diagrams: Single-Location Installations

Wiring Diagram 1: Connect occupancy sensing switch to ground

Single-Location Installation (120-277 V~)^{1, 2}

-OPS6M2U-DV³, -VPS6M2U-DV³

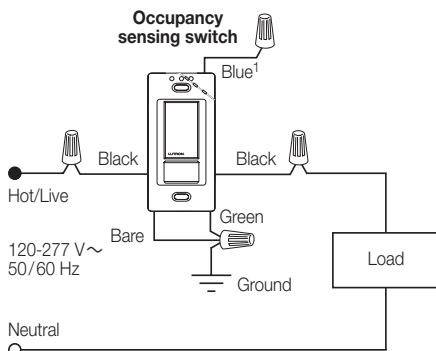

Wiring Diagram 2: Connect occupancy sensing switch to neutral

Single-Location Installation (120-277 V~)^{1, 2}

-OPS6M2U-DV⁴, -VPS6M2U-DV⁴

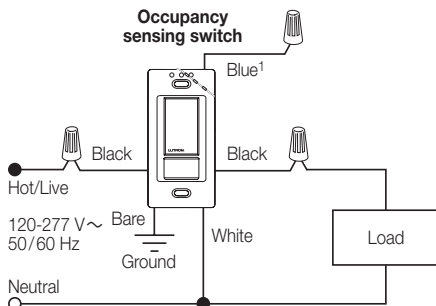

- ¹ When using controls in single location installations, tighten the blue terminal or cap blue wire. Do NOT connect the blue terminal/wire to any other wire or to ground.
- ² Fan load applies to 120 V~ only (not for use with 277 V~).
- ³ Green wire is connected to ground.
- ⁴ Wire covered by white sleeve is connected to neutral.

Continued on next page...

Job Name:	Model Numbers:
Job Number:	

Wiring Diagrams: 3-way Installations with Standard Mechanical 3-way Switch

Wiring Diagram 3: Connect occupancy sensing switch to ground
 3-way Installation with Standard Mechanical 3-way Switch (120-277 V~)^{1, 2, 3}
 -OPS6M2U-DV⁴, -VPS6M2U-DV⁴

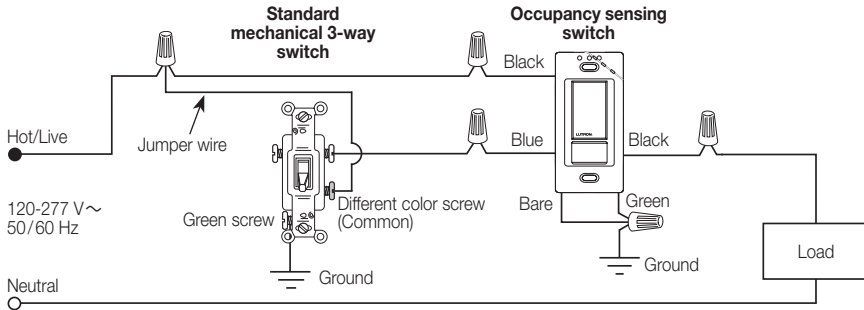

OR

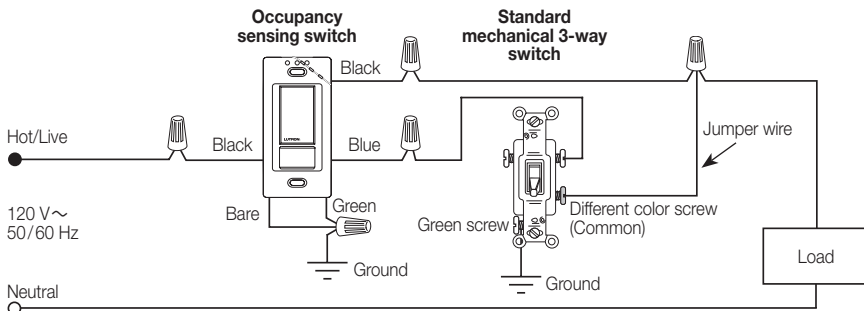

- ¹ Only one Occupancy sensing switch can be used per multi-location circuit.
- ² A single standard mechanical 3-way switch or up to 9 companion switches may be connected to most Occupancy sensing switches. Standard mechanical 3-way switch cannot be combined with companion switch. Total blue terminal wire length may be up to 150 ft (46 m).
- ³ Fan load applies to 120 V~ only (not for use with 277 V~).
- ⁴ Green wire is connected to ground.

Continued on next page...

Job Name:	Model Numbers:
Job Number:	

Wiring Diagrams: 3-way Installations with Standard Mechanical 3-way Switch *(continued)*

Wiring Diagram 4: Connect occupancy sensing switch to neutral
 3-way Installation with Standard Mechanical 3-way Switch (120-277 V~)^{1, 2, 3}
 -OPS6M2U-DV⁴, -VPS6M2U-DV⁴

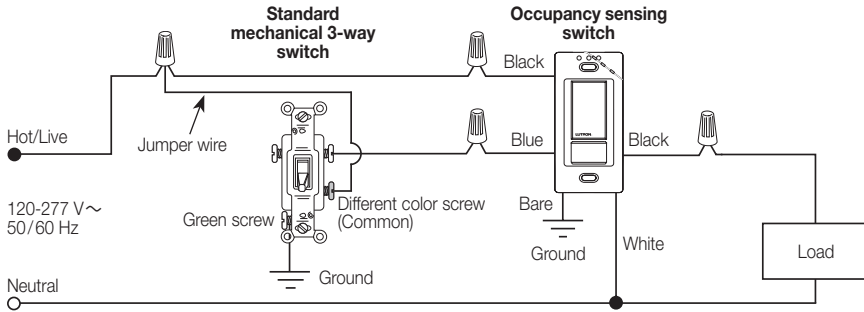

OR

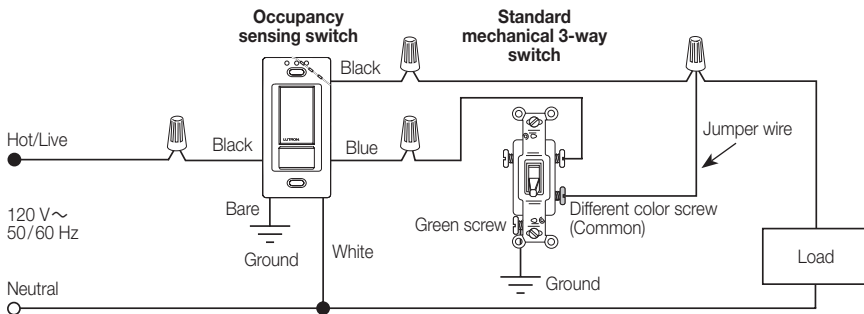

- ¹ Only one Occupancy sensing switch can be used per multi-location circuit.
- ² A single standard mechanical 3-way switch or up to 9 companion switches may be connected to most Occupancy sensing switches. Standard mechanical 3-way switch cannot be combined with companion switch. Total blue terminal wire length may be up to 150 ft (46 m).
- ³ Fan load applies to 120 V~ only (not for use with 277 V~).
- ⁴ Wire covered by white sleeve is connected to neutral.

Continued on next page...

Job Name:	Model Numbers:
Job Number:	

Wiring Diagrams: Multi-location Installations

Wiring Diagram 5: Connect occupancy sensing switch to ground

Multi-Location Installation (120 V~)^{1, 2, 3}

-OPS6M2U-DV⁴, -VPS6M2U-DV⁴

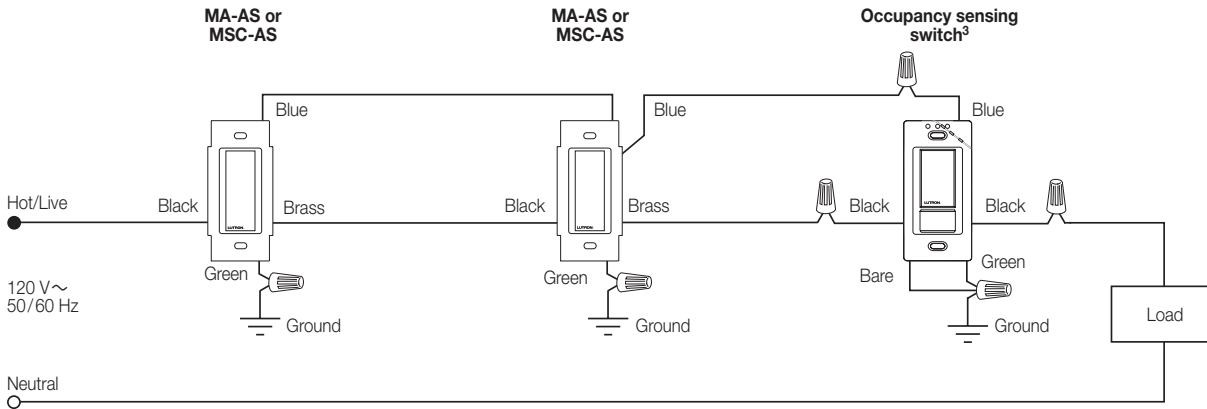

Wiring Diagram 6: Connect occupancy sensing switch to neutral

Multi-Location Installation (120 V~)^{1, 2, 3}

-OPS6M2U-DV⁵, -VPS6M2U-DV⁵ with MA-AS or MSC-AS

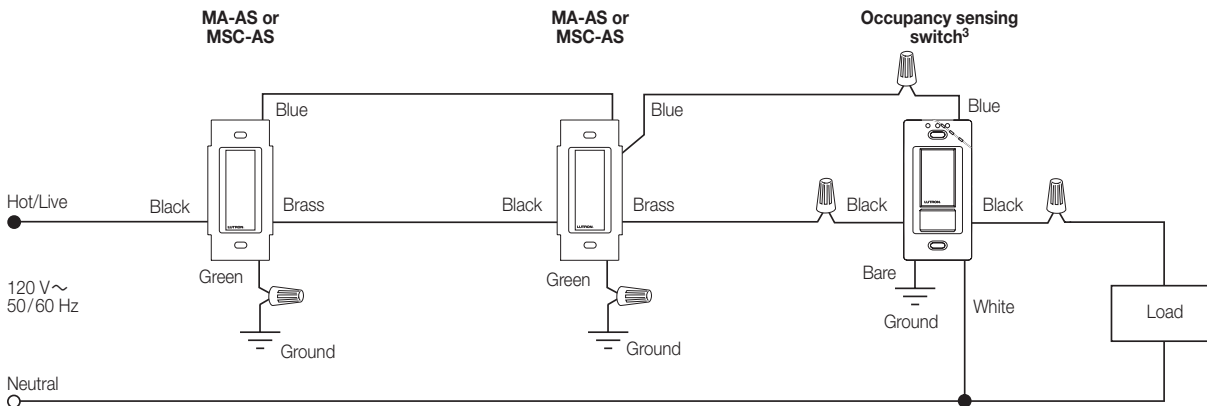

- 1 Only one Occupancy sensing switch can be used per multi-location circuit.
- 2 A single standard mechanical 3-way switch or up to 9 companion switches may be connected to most Occupancy sensing switches. Standard mechanical 3-way switch cannot be combined with companion switch. Total blue terminal wire length may be up to 150 ft (46 m).
- 3 Occupancy sensing switch can be installed in any location.
- 4 Green wire is connected to ground.
- 5 Wire covered by white sleeve is connected to neutral.

Continued on next page...

Job Name:	Model Numbers:
Job Number:	

Wiring Diagrams: Multi-location Installations *(continued)*

Wiring Diagram 7: Connect occupancy sensing switch to ground

Multi-Location Installation (277 V~)^{1, 2, 3, 4}

-OPS6M2U-DV⁵, -VPS6M2U-DV⁵ with MA-AS-277 or MSC-AS-277

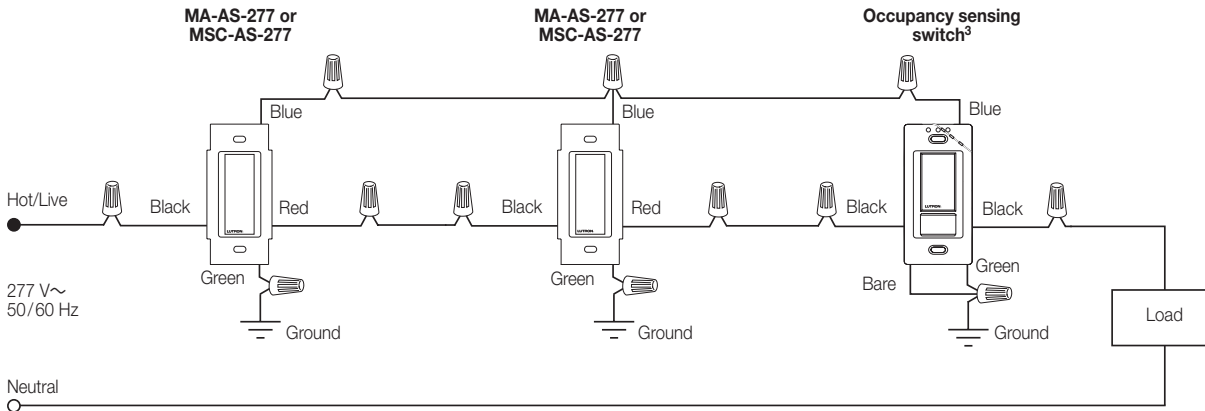

Wiring Diagram 8: Connect occupancy sensing switch to neutral

Multi-Location Installation (277 V~)^{1, 2, 3, 4}

-OPS6M2U-DV⁶, -VPS6M2U-DV⁶ with MA-AS-277 or MSC-AS-277

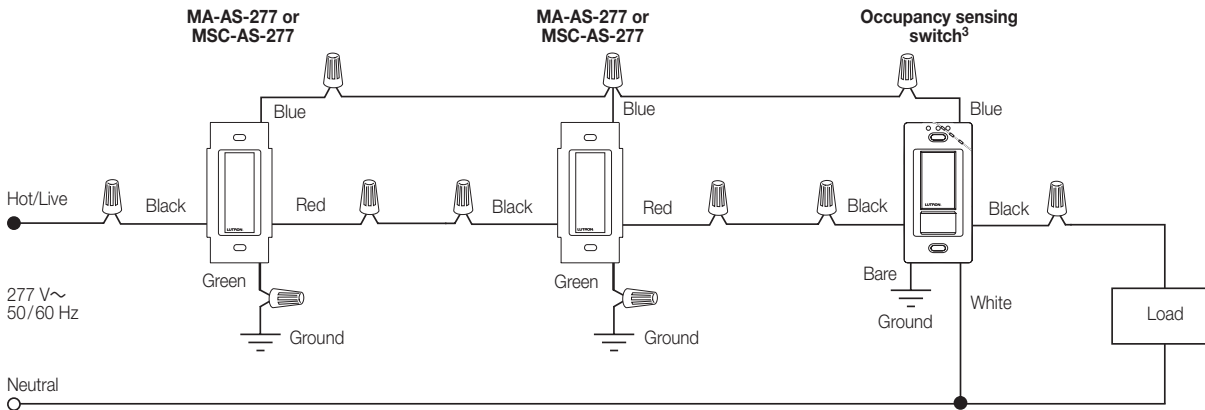

- ¹ Only one Occupancy sensing switch can be used per multi-location circuit.
- ² A single standard mechanical 3-way switch or up to 9 companion switches may be connected to most Occupancy sensing switches. Standard mechanical 3-way switch cannot be combined with companion switch. Total blue terminal wire length may be up to 150 ft (46 m).
- ³ Occupancy sensing switch can be installed in any location.
- ⁴ Fan load applies to 120 V~ only (not for use with 277 V~).
- ⁵ Green wire is connected to ground.
- ⁶ Wire covered by white sleeve is connected to neutral.

Job Name:	Model Numbers:
Job Number:	

Colors and Finishes

Gloss Finishes

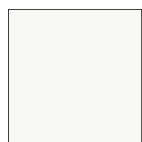

White
WH



Ivory
IV

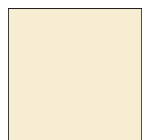

Almond
AL

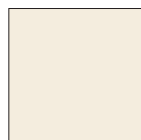

Light Almond
LA

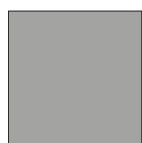

Gray
GR



Brown
BR



Black
BL

Satin Finishes



Hot
HT



Merlot
MR



Plum
PL



Turquoise
TQ



Taupe
TP



Eggshell
ES



Biscuit
BI



Snow
SW



Palladium
PD



Midnight
MN



Sienna
SI

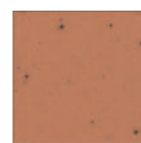

Terracotta
TC



Greenbriar
GB



Bluestone
BG



Mocha Stone
MS



Goldstone
GS



Desert Stone
DS



Stone
ST



Limestone
LS



Sea Glass
SG

- Due to printing limitations, colors and finishes shown cannot be guaranteed to match actual product colors perfectly.
- Color chip keychains are available for more precise color matching:
 - Gloss Finishes: DG-CK-1
 - Satin Finishes: SC-CK-1

<p>Job Name:</p> <p>Job Number:</p>	<p>Model Numbers:</p>
--	------------------------------

Maestro® Occupancy sensing switch

To power the sensing circuit, occupancy sensing switches require a small flow of current when the load is in the OFF state. This can be accomplished by connecting the power supply return wire to ground or to neutral.

Local codes in certain municipalities require that a neutral conductor be run to the switch box, regardless of construction. In one particular instance, installing occupancy sensors that use the ground wire to function is not permitted.

The MS-OPS6M2U-DV and MS-VPS6M2U products allow the installer to configure the device to connect to either ground or neutral.

- To connect to ground, simply install the product in its "out-of-the box" condition.
- To connect to neutral, install the supplied white sleeve over the green wire.

For more information about occupancy sensing switches and the National Electrical code, see:

www.lutron.com/TechnicalDocumentLibrary/048469.pdf

Features

- Passive infrared sensors with exclusive Lutron® XCT™ Technology for fine motion detection
- 180° sensor field-of-view
- Up to 30 ft x 30 ft (9 m x 9 m) [900 ft² (81 m²)] major motion coverage and 20 ft x 20 ft (6 m x 6 m) [400 ft² (36 m²)] minor motion coverage
- Occupancy version can be set to Auto-ON/Auto-OFF or Manual-ON/Auto-OFF
- Vacancy version available to meet CA Title 24 requirements
- Adjustable timeout (1, 5, 15, or 30 minutes) and high/low sensitivity adjustment
- Occupancy sensing switch loads: incandescent, halogen, ELV, MLV, CFL, LED, magnetic fluorescent, electronic fluorescent, and fan.

Models available

MS-OPS6M2U-DV

MS-VPS6M2U-DV

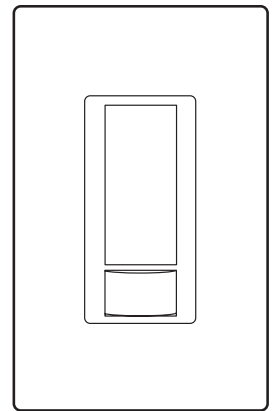

MS-OPS6M2U-DV
MS-VPS6M2U-DV

<p>Job Name:</p> <p>Job Number:</p>	<p>Model Numbers:</p>
--	------------------------------

Specifications

Regulatory Approvals

- UL® Listed to U.S. and Canadian safety requirements.
- NOM Certification (pending).

Power

- 120–277 V~ 50/60 Hz¹

Key Design Features

- All lighting loads.
- Crush/tamper resistant lens.
- Smart ambient light detection.
- Adaptive switching algorithm for extended relay life.
- XCT™ Technology for fine motion detection.

Environment

- Ambient operating temperature: 32 °F to 104 °F (0 °C to 40 °C), 0%–90% humidity, non-condensing. Indoor use only.

Warranty

- 5-Year Limited Warranty. For additional Warranty information, please visit www.lutron.com/TechnicalDocumentLibrary/Sensor_Warranty.pdf

Additional Information

- For Maestro® Occupancy sensing dimmer models, please see [Lutron® P/N 369270](#).
- For other Maestro® Occupancy sensing switch models, please see [Lutron® P/N 369666](#).
- For use with MA-AS, MSC-AS, MA-AS-277, or MSC-AS-277 to control the load from more than two locations, please see [Lutron® P/N 048435](#).
- For more information, please see www.lutron.com/occvacsensors
- Lutron Technical Hotline: 1.800.523.9466.

Advanced Features

Switching

Adaptive zero cross feature maximizes relay life by switching at the point of minimum energy on the AC power curve. Actively adapts to variations in relay timing.

XCT™ Technology

Advanced sensing technology for fine motion detection ensures that the lights stay on while the room is occupied, and that the sensor does not turn on falsely when there is no occupancy in the room. For more information, see www.lutron.com/TechnicalDocumentLibrary/white%20paper%20XCT%204-23-09%20B.pdf

¹ Maximum current ratings for individual models are provided in the **Selection Matrix** on page 4.

Job Name:	Model Numbers:
Job Number:	

Custom Settings

Ambient Light Detection

- Lights turn on only if natural light in room is low.
- Smart—Ambient light threshold adjusts precisely to the user's preference.

Instructions: If switch turns on when there is enough natural light, or if switch does not turn on when there is not enough natural light, press the large button within 5 seconds of entering the room. Over time, this interaction will "teach" the switch your preferred setting.

Sensor Operation

- Occupancy/Vacancy: Auto-ON/Auto-OFF or Manual-ON/Auto-OFF
- Vacancy only: Manual-ON/Auto-OFF only

Timeout Options

(See **Additional Features** on page 4 for default settings)

- 1 Minute
- 5 Minutes
- 15 Minutes
- 30 Minutes

Sensitivity Options

- High sensitivity (default)
- Low sensitivity

Auto-ON Options

(MS-OPS only)

- Occupancy (default): Auto-ON/Auto-OFF
- Vacancy*: Manual-ON/Auto-OFF
- Low Light: Lights turn on only if needed (if ambient light is below threshold)

* There is a 15-second grace period that begins when the lights are automatically turned off, during which the lights will automatically turn back on in response to motion. This grace period is provided as a safety and convenience feature in the event that the lights turn off while the room is still occupied, so that the user does not need to manually turn the lights back on. After 15 seconds, the grace period expires and the lights must be manually turned on.

Manual Off-While-Occupied Options

(MS-OPS only — see **Additional Features** on page 4 for default setting)

- Enabled
 - When the Occupancy sensing switch is manually turned off, the Occupancy sensing switch will not turn the lights back on automatically while the room is occupied.
 - Once the room is vacated, the Auto-ON feature returns to normal operation after the timeout period has expired.
 - This may be the preference in conference rooms or classrooms while viewing presentations. This feature requires motion to keep the lights off.
- Disabled
 - When the Occupancy sensing switch is manually turned off, the Auto-ON feature will return to normal operation after 25 seconds.
 - This may be the preference if the user always wants the lights to turn on upon entering and the lights to turn off when the room is vacant.

<p>Job Name:</p> <p>Job Number:</p>	<p>Model Numbers:</p>
--	------------------------------

Selection Matrix

Vacancy only ² (Title 24 compliant)										Single-pole / 3-way capability
Single-pole only										
Works with standard mechanical 3-way switch ³										Max current rating
Works with companion switch ^{3, 4}										
All lighting loads (120 V~ only)										
All lighting loads (120–277 V~ only)										
Fan (120 V~)										
Light + Fan (120 V~)										Off-state power
Neutral or ground wire required for functionality ⁵										
Minimum load required										

Model Number¹

MS-OPS6M2U-DV-XX			✓	✓		6 A	3 A	3 A	✓	
MS-VPS6M2U-DV-XX	✓		✓	✓		6 A	3 A	3 A	✓	

¹ XX in model number represents color/finish code.

² Occupancy sensors can be configured as Auto-ON/Auto-OFF or Manual-ON/Auto-OFF. Vacancy sensors are configured as Manual-ON/Auto-OFF only.

³ Standard mechanical 3-way switch cannot be combined with companion switch.

⁴ Companion switch MA-AS, MSC-AS, MA-AS-277, or MSC-AS-277 is required for multi-location installations (more than two locations controlling the same lighting circuit). Up to nine companion switches may be connected.

⁵ The green wire can be connected to ground or, when covered by the white sleeve, can be connected to neutral (see illustrations on page 7).

Additional Features

Crush/tamper-resistant lens						
Ambient light detection						
Switching						
XCT™ technology						
Manual off-while-occupied default setting						
Default timeout (minutes)						

Model Number¹

MS-OPS6M2U-DV-XX	✓	Smart	Adaptive	✓	Enabled	15
MS-VPS6M2U-DV-XX	✓	Smart	Adaptive	✓		15

¹ XX in model number represents color/finish code.

Job Name:	Model Numbers:
Job Number:	

Occupancy Sensing Switch Placement and Operation

- The ability of the Occupancy sensing switch to detect motion requires line-of-sight of room occupants. The Occupancy sensing switch must have an unobstructed view of the room.
- Hot objects and moving air currents can affect the performance of the Occupancy sensing switch.
- The performance of the Occupancy sensing switch depends on a temperature differential between the ambient room temperature and that of room occupants. Warmer rooms may reduce the ability of the Occupancy sensing switch to detect occupants.

Definitions

Major motion: movement of a person entering or passing through an area.

Minor motion: movement of a person occupying an area and engaging in small activities (e.g., reaching for a telephone, turning the pages of a book, opening a file folder, picking up a coffee cup).

NEMA WD7 Coverage

 Major motion coverage: 900 ft² (81 m²)

 Minor motion coverage: 400 ft² (36 m²)

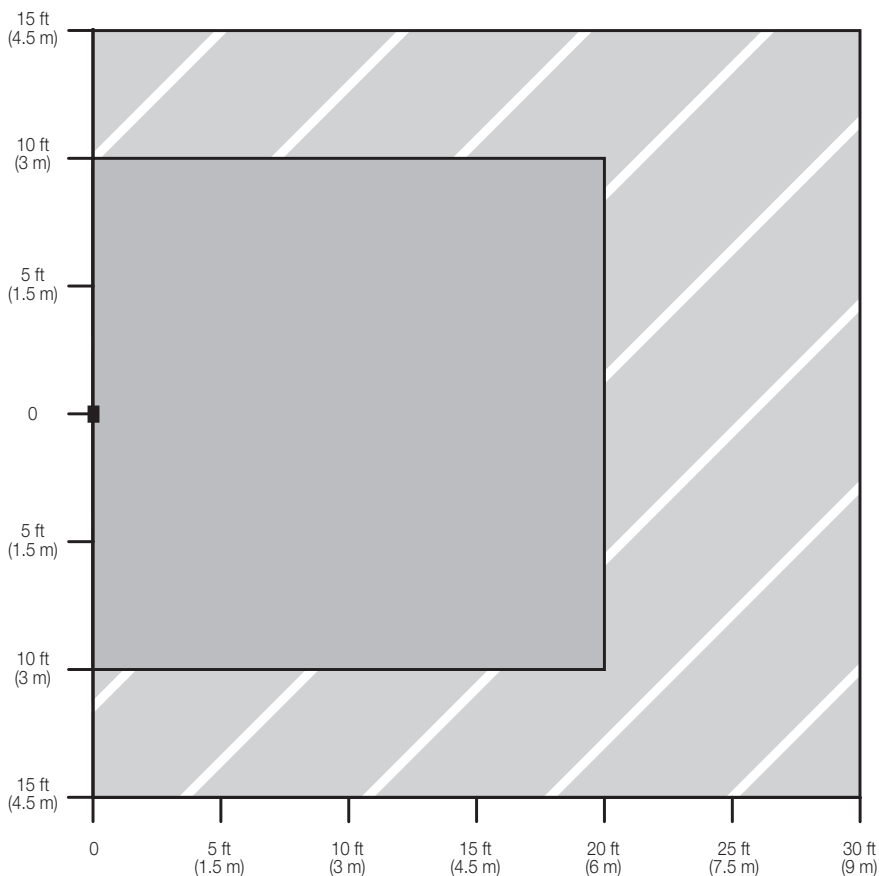

Horizontal Beam Diagram

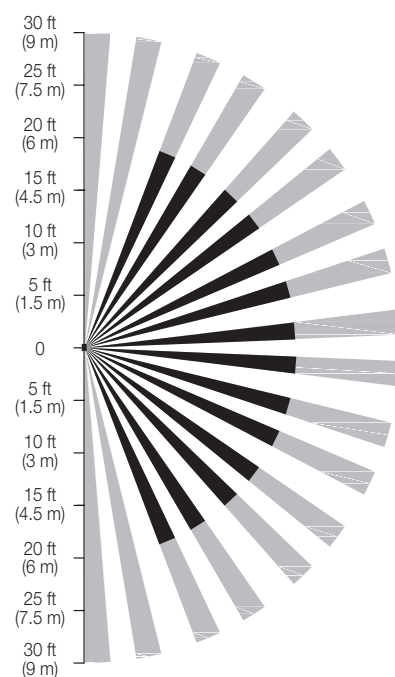

Vertical Beam Diagram

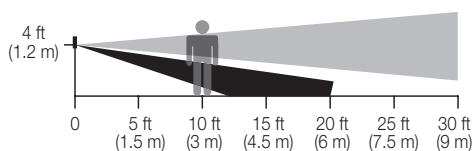

Job Name:	Model Numbers:
Job Number:	

Dimensions

Measurements shown as: in (mm).

Front View

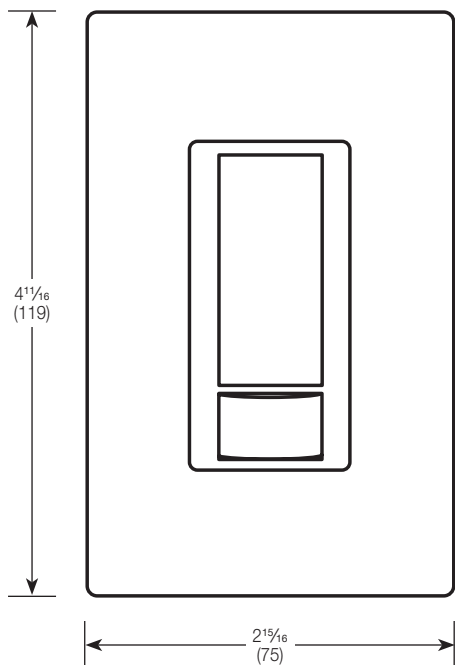

Side View

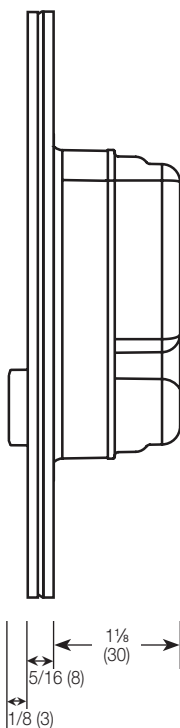

Mounting

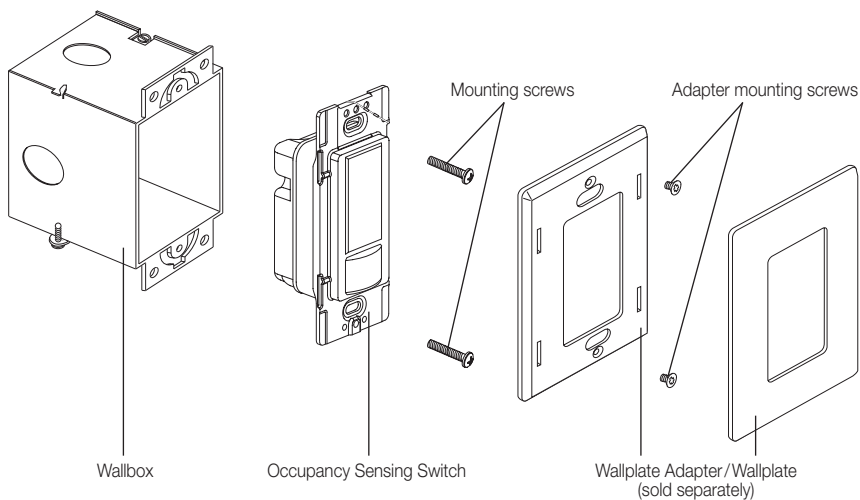

Operation

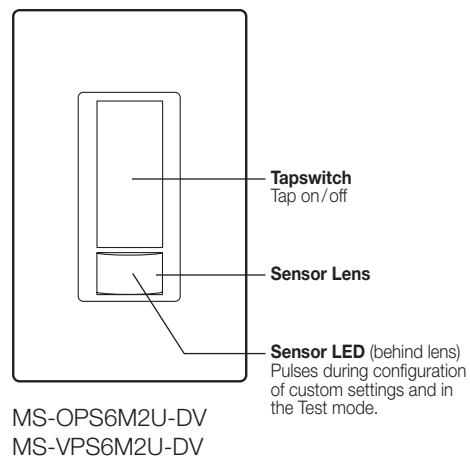

Job Name:	Model Numbers:
Job Number:	

Converting Ground Wire to Neutral Wire

The green wire can be connected to ground or, when covered by the white sleeve, can be connected to neutral.

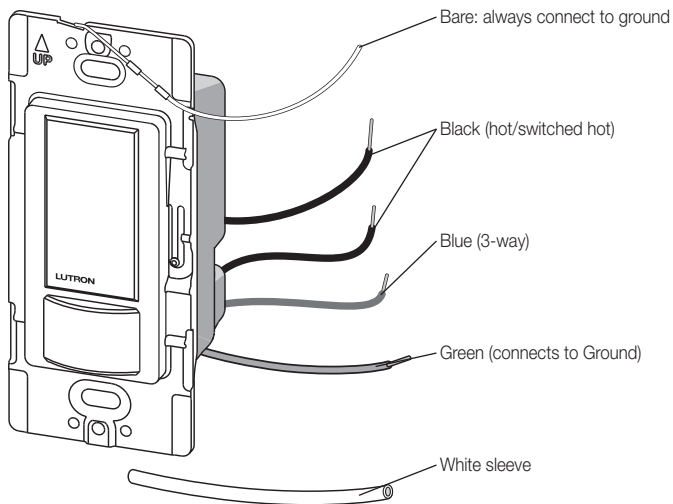

Slide white sleeve over green wire until flush with back cover.

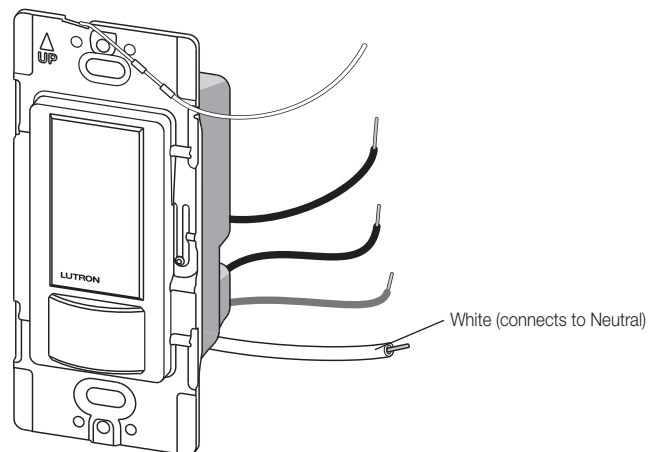
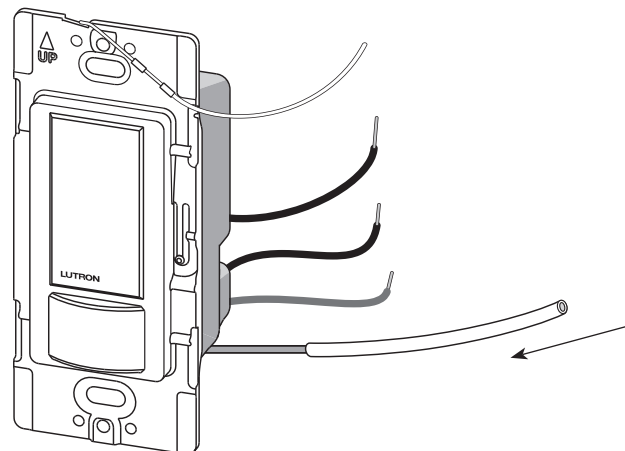
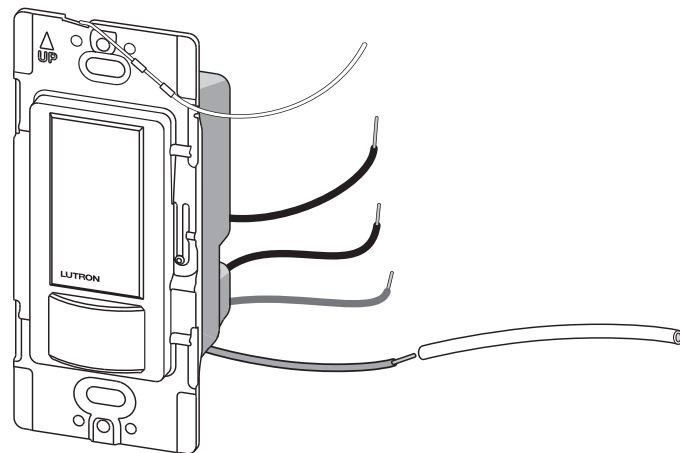

Job Name:	Model Numbers:
Job Number:	

Wiring Diagrams: Single-Location Installations

Wiring Diagram 1: Connect occupancy sensing switch to ground

Single-Location Installation (120-277 V~)^{1, 2}

-OPS6M2U-DV³, -VPS6M2U-DV³

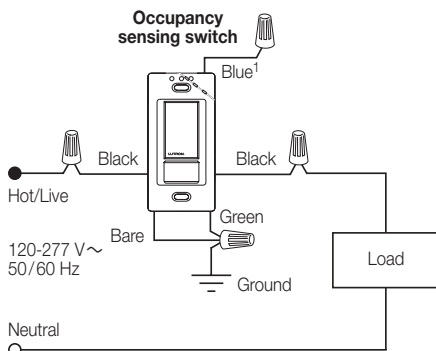

Wiring Diagram 2: Connect occupancy sensing switch to neutral

Single-Location Installation (120-277 V~)^{1, 2}

-OPS6M2U-DV⁴, -VPS6M2U-DV⁴

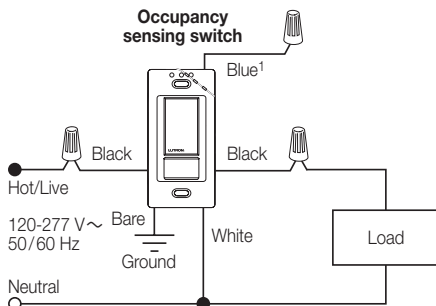

- ¹ When using controls in single location installations, tighten the blue terminal or cap blue wire. Do NOT connect the blue terminal/wire to any other wire or to ground.
- ² Fan load applies to 120 V~ only (not for use with 277 V~).
- ³ Green wire is connected to ground.
- ⁴ Wire covered by white sleeve is connected to neutral.

Continued on next page...

Job Name:	Model Numbers:
Job Number:	

Wiring Diagrams: 3-way Installations with Standard Mechanical 3-way Switch

Wiring Diagram 3: Connect occupancy sensing switch to ground
 3-way Installation with Standard Mechanical 3-way Switch (120-277 V~)^{1, 2, 3}
 -OPS6M2U-DV⁴, -VPS6M2U-DV⁴

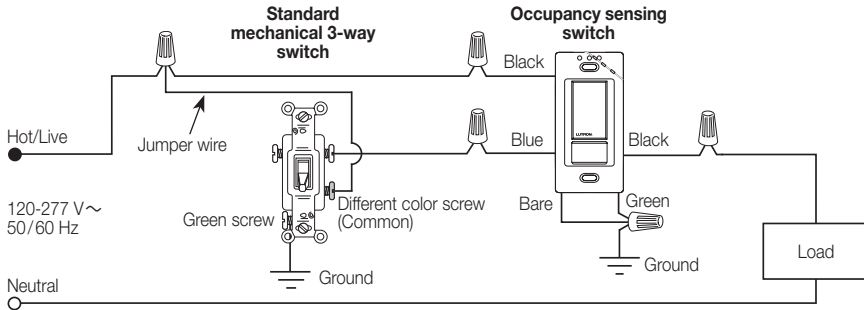

OR

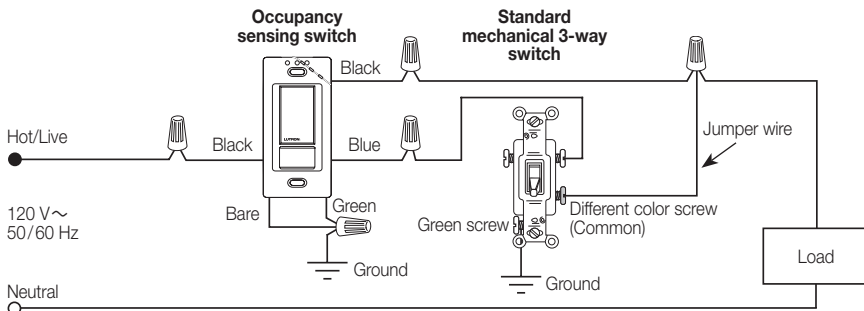

- ¹ Only one Occupancy sensing switch can be used per multi-location circuit.
- ² A single standard mechanical 3-way switch or up to 9 companion switches may be connected to most Occupancy sensing switches. Standard mechanical 3-way switch cannot be combined with companion switch. Total blue terminal wire length may be up to 150 ft (46 m).
- ³ Fan load applies to 120 V~ only (not for use with 277 V~).
- ⁴ Green wire is connected to ground.

Continued on next page...

Job Name:	Model Numbers:
Job Number:	

Wiring Diagrams: 3-way Installations with Standard Mechanical 3-way Switch *(continued)*

Wiring Diagram 4: Connect occupancy sensing switch to neutral
 3-way Installation with Standard Mechanical 3-way Switch (120-277 V~)^{1, 2, 3}
 -OPS6M2U-DV⁴, -VPS6M2U-DV⁴

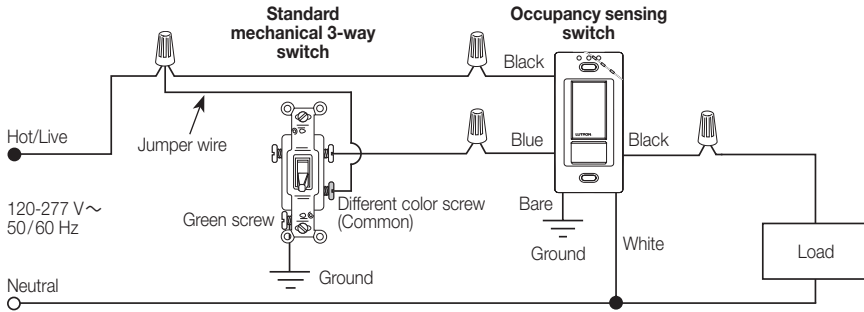

OR

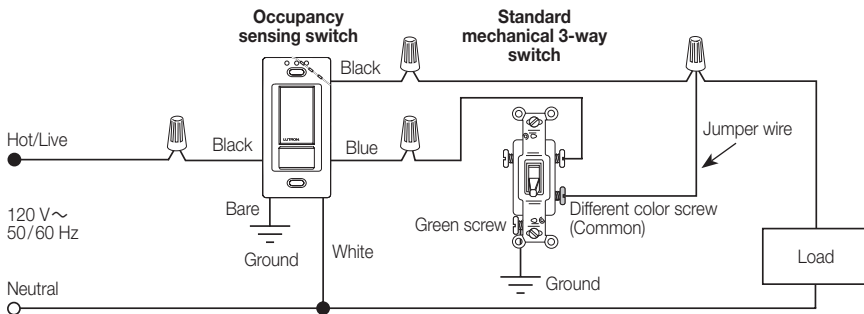

- ¹ Only one Occupancy sensing switch can be used per multi-location circuit.
- ² A single standard mechanical 3-way switch or up to 9 companion switches may be connected to most Occupancy sensing switches. Standard mechanical 3-way switch cannot be combined with companion switch. Total blue terminal wire length may be up to 150 ft (46 m).
- ³ Fan load applies to 120 V~ only (not for use with 277 V~).
- ⁴ Wire covered by white sleeve is connected to neutral.

Continued on next page...

Job Name:	Model Numbers:
Job Number:	

Wiring Diagrams: Multi-location Installations

Wiring Diagram 5: Connect occupancy sensing switch to ground

Multi-Location Installation (120 V~)^{1, 2, 3}

-OPS6M2U-DV⁴, -VPS6M2U-DV⁴

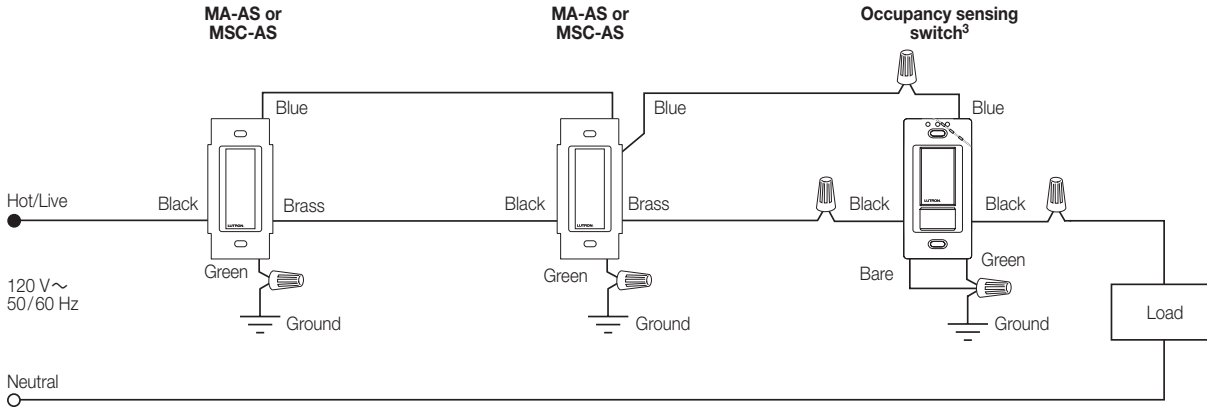

Wiring Diagram 6: Connect occupancy sensing switch to neutral

Multi-Location Installation (120 V~)^{1, 2, 3}

-OPS6M2U-DV⁵, -VPS6M2U-DV⁵ with MA-AS or MSC-AS

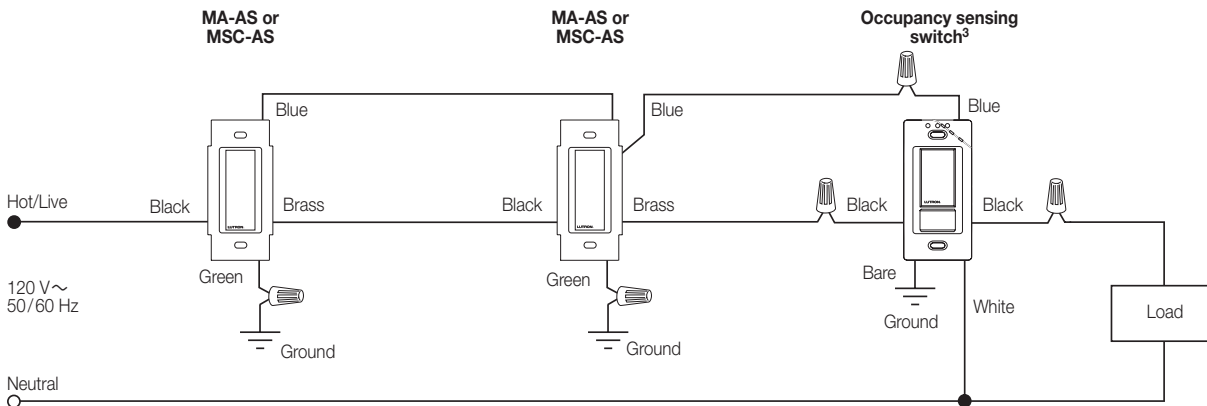

- 1 Only one Occupancy sensing switch can be used per multi-location circuit.
- 2 A single standard mechanical 3-way switch or up to 9 companion switches may be connected to most Occupancy sensing switches. Standard mechanical 3-way switch cannot be combined with companion switch. Total blue terminal wire length may be up to 150 ft (46 m).
- 3 Occupancy sensing switch can be installed in any location.
- 4 Green wire is connected to ground.
- 5 Wire covered by white sleeve is connected to neutral.

Continued on next page...

Job Name:	Model Numbers:
Job Number:	

Wiring Diagrams: Multi-location Installations *(continued)*

Wiring Diagram 7: Connect occupancy sensing switch to ground

Multi-Location Installation (277 V~)^{1, 2, 3, 4}

-OPS6M2U-DV⁵, -VPS6M2U-DV⁵ with MA-AS-277 or MSC-AS-277

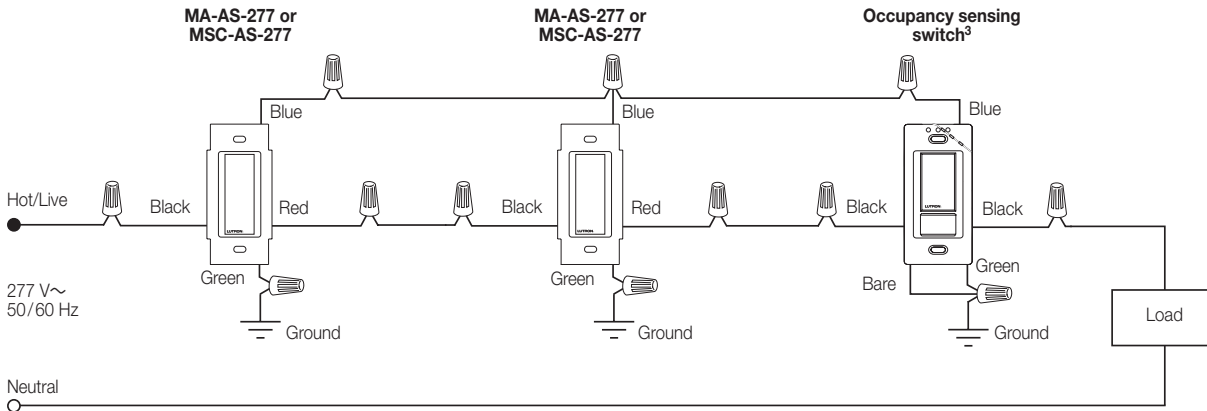

Wiring Diagram 8: Connect occupancy sensing switch to neutral

Multi-Location Installation (277 V~)^{1, 2, 3, 4}

-OPS6M2U-DV⁶, -VPS6M2U-DV⁶ with MA-AS-277 or MSC-AS-277

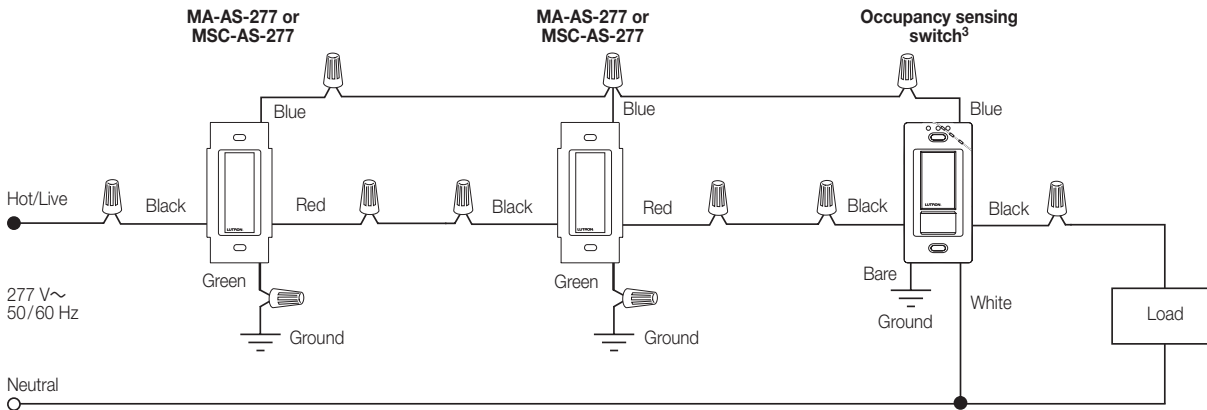

- ¹ Only one Occupancy sensing switch can be used per multi-location circuit.
- ² A single standard mechanical 3-way switch or up to 9 companion switches may be connected to most Occupancy sensing switches. Standard mechanical 3-way switch cannot be combined with companion switch. Total blue terminal wire length may be up to 150 ft (46 m).
- ³ Occupancy sensing switch can be installed in any location.
- ⁴ Fan load applies to 120 V~ only (not for use with 277 V~).
- ⁵ Green wire is connected to ground.
- ⁶ Wire covered by white sleeve is connected to neutral.

Job Name:	Model Numbers:
Job Number:	

Colors and Finishes

Gloss Finishes

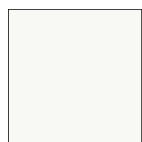

White
WH



Ivory
IV

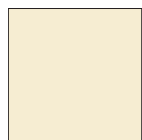

Almond
AL



Light Almond
LA

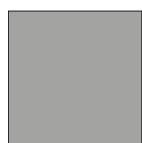

Gray
GR



Brown
BR



Black
BL

Satin Finishes



Hot
HT



Merlot
MR



Plum
PL



Turquoise
TQ



Taupe
TP

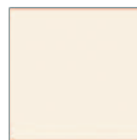

Eggshell
ES



Biscuit
BI



Snow
SW



Palladium
PD



Midnight
MN



Sienna
SI

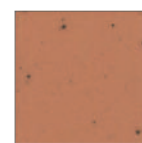

Terracotta
TC



Greenbriar
GB



Bluestone
BG

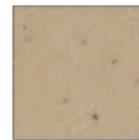

Mocha Stone
MS



Goldstone
GS



Desert Stone
DS



Stone
ST



Limestone
LS



Sea Glass
SG

- Due to printing limitations, colors and finishes shown cannot be guaranteed to match actual product colors perfectly.
- Color chip keychains are available for more precise color matching:
 - Gloss Finishes: DG-CK-1
 - Satin Finishes: SC-CK-1

<p>Job Name:</p> <p>Job Number:</p>	<p>Model Numbers:</p>
--	------------------------------