

Q60LAF Series Laser Adjustable-Field Sensors

Long-Range Self-Contained Adjustable-Field Laser Sensors

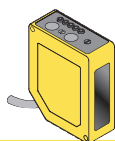

Features

- Long-range adjustable-field background suppression sensor detects objects within a defined sensing field, and ignores objects located beyond the sensing field cutoff
- Powerful visible red laser sensing beam, class 1 and class 2 models available
- Two-turn, logarithmic cutoff point adjustment for easy setting of cutoff point at long range; rotating pointer indicates relative cutoff point setting
- Easy push-button or remote setting of light/dark operate and output timing; continuous status indicators verify all settings at a glance
- Output ON and/or OFF delays adjustable from 8 milliseconds to 16 seconds
- Tough ABS/polycarbonate blend housing is rated IEC IP67; NEMA 6
- Models available for 10-30V dc operation or universal voltage (12 to 250V dc or 24 to 250V ac, 50/60 Hz)

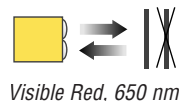

Models

Models	Cutoff Point	Cable*	Supply Voltage	Output Type	Excess Gain (performance based on 90% reflectance white test card)
Class 1 Laser					
Q60BB6LAF1400	Adjustable: 200 mm to 1400 mm (8" to 55")	5-wire 2 m (6.5')	10 to 30V dc	Bipolar NPN/PNP	
Q60BB6LAF1400Q		5-pin Euro-style QD fitting			
Q60BB6LAF1400QP		5-pin Euro-style QD pigtail			
Q60VR3LAF1400		5-wire 2 m (6.5')	Universal Voltage 12 to 250V dc or 24 to 250V ac	E/M Relay (SPDT), N.C. and N.O. contacts	
Q60VR3LAF1400Q1		4-pin Micro-style QD fitting		E/M Relay (SPST), N.O. contact	
Class 2 Laser					
Q60BB6LAF2000	Adjustable: 200 mm to 2000 mm (8" to 80")	5-wire 2 m (6.5')	10 to 30V dc	Bipolar NPN/PNP	
Q60BB6LAF2000Q		5-pin Euro-style QD fitting			
Q60BB6LAF2000QP		5-pin Euro-style QD pigtail			
Q60VR3LAF2000		5-wire 2 m (6.5')	Universal Voltage 12 to 250V dc or 24 to 250V ac	E/M Relay (SPDT), N.C. and N.O. contacts	
Q60VR3LAF2000Q1		4-pin Micro-style QD fitting		E/M Relay (SPST), N.O. contact	

* 9 meter cables are available by adding suffix "W/30" to the model number of any cabled sensor (e.g., Q60BB6LAF1400 W/30). A model with a QD connector requires a mating cable; see page 8.

See Safety Use Warning on back page.

Q60LAF Series Laser Adjustable-Field Sensors

Overview

The Q60LAF sensor is a full-featured adjustable-field sensor. These adjustable-field sensors are able to detect objects of relatively low reflectivity, while ignoring other objects in the background (beyond the cutoff point). The cutoff distance is mechanically adjustable, using the 2-turn adjustment screw (Figure 1). A rotating pointer indicates the relative cutoff position. (The indicator moves clockwise to show increasing distance.) The collimated laser emitter produces a small, bright spot, allowing easy alignment and precision sensing of relatively small objects at long range.

Two push buttons (ON Delay and OFF Delay) are used to set the output delay options, to toggle between light and dark operate modes and to lock out the push buttons for security purposes. For 10 to 30V dc models, these functions also may be accomplished using the remote wire.

Seven LED indicators show, during RUN mode, the sensor configuration and operating status. During Delay Configuration, 5 of the LEDs combine to form a single light bar that indicates relative ON or OFF delay time.

Adjustable-Field Sensing – Theory of Operation

In operation, the Q60LAF compares the reflections of its emitted light beam (E) from an object back to the sensor's two differently-aimed detectors R1 and R2 (see Figure 2). If the near detector (R1) light signal is stronger than the far detector (R2) light signal (see object A, closer than the cutoff distance), the sensor responds to the object. If the far detector (R2) light signal is stronger than the near detector (R1) light signal (see object B, object beyond the cutoff distance), the sensor ignores the object.

The cutoff distance for Q60LAF sensors is adjustable from 200 to 1400 mm (8" to 55") for Class 1 laser models, and 200 to 2000 mm (8" to 80") for Class 2 laser models. Objects lying beyond the cutoff distance are ignored.

In the drawings and discussion on this page and page 4, the letters E, R1, and R2 identify how the sensor's three optical elements (Emitter "E", Near Detector "R1", and Far Detector "R2") line up across the face of the sensor. The location of these elements defines the sensing axis (see Figure 3). The sensing axis becomes important in certain situations, such as those illustrated in Figures 7 and 8.

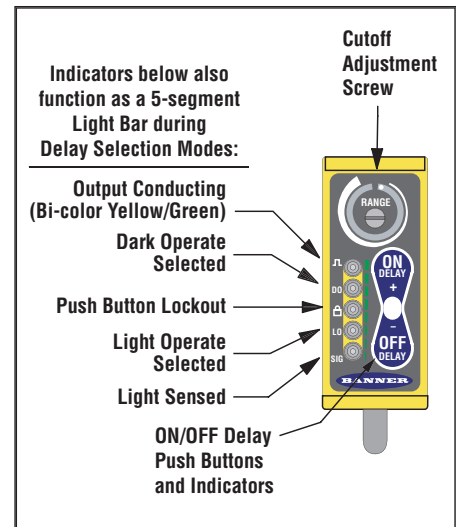

Figure 1. Q60LAF features

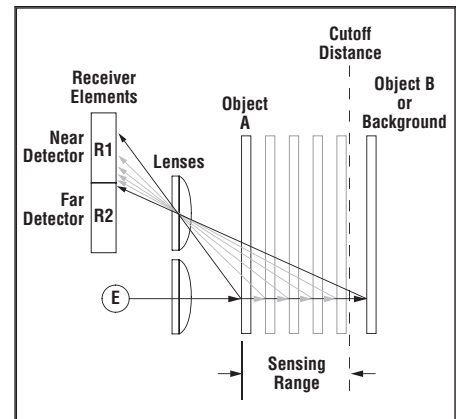

Figure 2. Adjustable field sensing concept

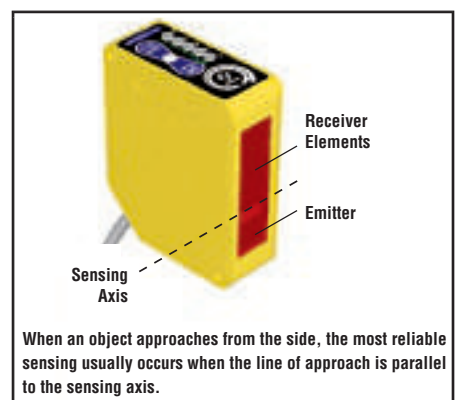

Figure 3. Q60 sensing axis

Q60LAF Series Laser Adjustable-Field Sensors

Color Sensitivity

The effects of object reflectivity on cutoff distance, though small, may be important for some applications.

The excess gain curves on page 1 were generated using a white test card of 90% reflectance. Objects with reflectivity of less than 90% reflect less light back to the sensor, and thus require proportionately more excess gain in order to be sensed with the same reliability as more reflective objects. When sensing an object of very low reflectivity, it may be especially important to sense it at or near the distance of maximum excess gain.

It is expected that at any given cutoff setting, the actual cutoff distance for lower reflectance targets will be slightly shorter than for higher reflectance targets (see Figure 4). This behavior is known as color sensitivity.

The percentage of deviation indicates a change in the cutoff point for either 18% gray or 6% black targets, relative to the cutoff point set for a 90% reflective white test card.

For example, the cutoff point decreases 10% for a 6% reflectance black target when the cutoff point is adjusted for 1700 mm (67") using a 90% reflectance white test card. In other words, the cutoff point for the black target is 1530 mm (60") for this setting.

NOTE: Sensing at closer than the minimum specified range is not guaranteed.

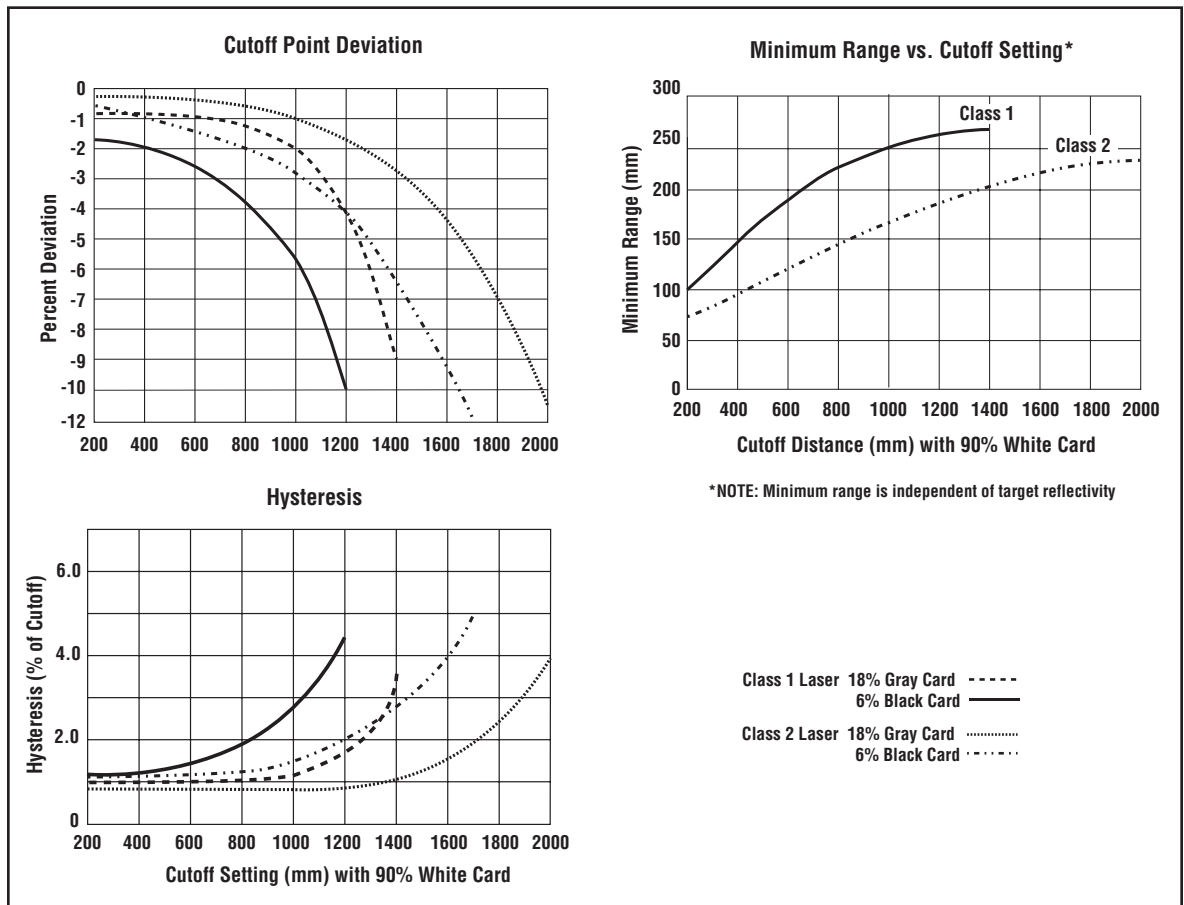

Figure 4. Q60LAF performance

Q60LAF Series Laser Adjustable-Field Sensors

Setting the Cutoff Distance

The cutoff distance for Q60LAF sensors may be adjusted between 200 mm and 1400 mm (8" to 55") for Class 1 laser models, and between 200 mm and 2000 mm (8" to 80") for Class 2 laser models.

To maximize contrast, position the lightest possible background to be used, at the closest position it will come to the sensor during use (Figure 5). Using a small screwdriver in the adjustment screw, adjust the cutoff distance until the threshold is reached and the green Light Sensed indicator changes state. (If the indicator never comes ON, the background is beyond the maximum sensing cutoff and will be ignored.) Note the position of the rotating cutoff position indicator at this position. Then repeat the procedure, using the darkest target, placed in its most distant position for sensing. Adjust the cutoff so that the indicator is midway between the two positions (Figure 6).

NOTE: Setting the cutoff distance adjustment screw to its maximum clockwise position places the receiver lens directly in front of the receiver elements and results in the Q60 performing as a long-range diffuse sensor.

Sensing Reliability

For highest sensitivity, the sensor should be mounted so that the target object will be sensed at or near the point of maximum excess gain. The excess gain curves on page 1 show excess gain vs. sensing distance for 200 mm, 1,200 mm and 2 m cutoffs. Maximum excess gain for a 200 mm cutoff occurs at a lens-to-object distance of about 150 mm, and for a 2 m cutoff, at about 500 mm. The background must be placed beyond the cutoff distance. Following these two guidelines makes it possible to detect objects of low reflectivity, even against close-in reflective backgrounds.

Background Reflectivity and Placement

Avoid mirror-like backgrounds that produce specular reflections. False sensor response will occur if a background surface reflects the sensor's light more strongly to the near detector (R1) than to the far detector (R2). The result is a false ON condition (Figure 7). Use of a diffusely-reflective (matte) background will cure this problem. Other possible solutions are to angle either the sensor or the background (in any plane) so that the background does not reflect back to the sensor.

An object beyond the cutoff distance, either moving or stationary (and when positioned as shown in Figure 8), can cause unwanted triggering of the sensor because it reflects more light to the near detector than to the far detector. The problem is easily remedied by rotating the sensor 90° to align the sensing axis horizontally. The object then reflects the R1 and R2 fields equally, resulting in no false triggering.

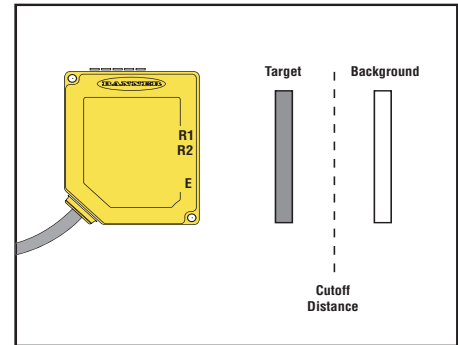

Figure 5. Set cutoff distance approximately midway between the farthest target and the closest background

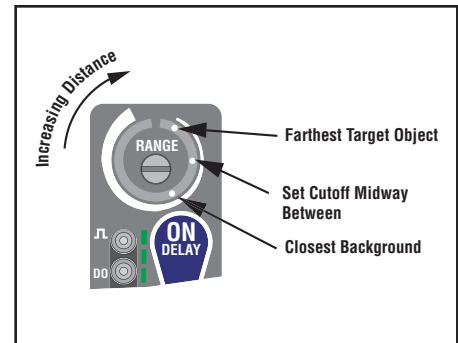

Figure 6. Setting the cutoff distance

Q60LAF Series Laser Adjustable-Field Sensors

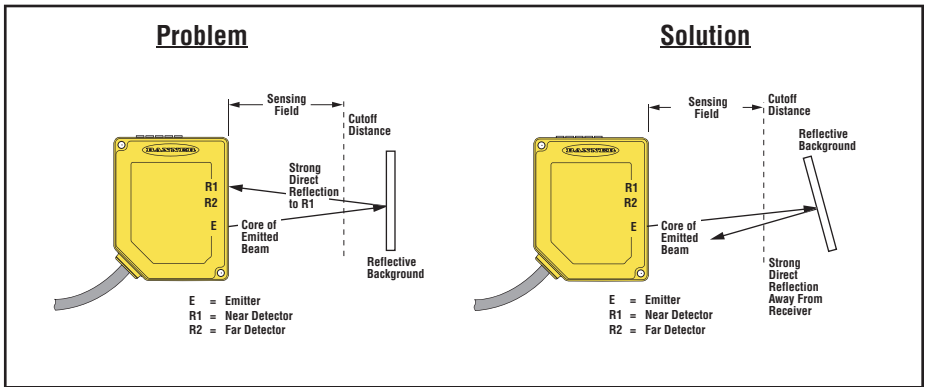

Figure 7. Reflective background – problem and solution

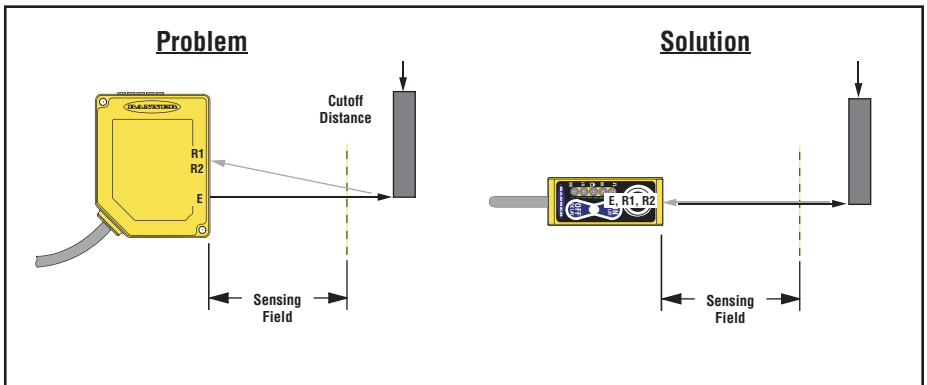

Figure 8. Object beyond cutoff distance — problem and solution

Q60LAF Series Laser Adjustable-Field Sensors

Setting the Output Delay

When target objects are in motion, an output delay can help prevent “hunting” or multiple outputs from process control equipment. A delay also can be used to monitor product flow, “downed goods”, or “jams” (product that is no longer being conveyed properly). A delay can also create a “smart zone,” enabling certain equipment to be directly controlled by the sensor, rather than requiring a PLC I/O.

The Q60LAF output may be delayed from 0.008 to 16 seconds, in 72 increments. Delay is indicated on the 5-segment light bar using single LED segments or combinations of them, in varying stages of intensity; see Figure 9.

To set a delay, single-click the appropriate button or pulse the remote wire (DC models only) to enable the process. Then use the + or – button or the appropriate remote wire pulses to increase or decrease the delay (single-click to adjust the delay by one step, or hold the button for a rapid increase/decrease).

Step Number	Delay Time (Seconds)	LED Status
0	No Delay	
8	0.062	
24	0.25	
40	1.0	
56	4.0	
72	16	

Figure 9. ON/OFF Delay options (major increments depicted)

Output ON-Delay – 4 second time-out		
	Push Button	Remote (DC models only) 0.04 sec. < T < 0.8 sec.
Enter ON-Delay Setup	Single-Click 	
Increase ON-Delay	Single-Click Step Increment 	Enable ON-Delay Increment
	Press and Hold Rapid Increment 	Step Increment or Rapid Increment
Decrease ON-Delay	Single-Click Step Decrement 	Enable ON-Delay Decrement
	Press and Hold Rapid Decrement 	Step Decrement or Rapid Decrement

Output OFF-Delay – 4 second time-out		
	Push Button	Remote (DC models only) 0.04 sec. < T < 0.8 sec.
Enter OFF-Delay Setup	Single-Click 	
Increase OFF-Delay	Single-Click Step Increment 	Enable OFF-Delay Increment
	Press and Hold Rapid Increment 	Step Increment or Rapid Increment
Decrease OFF-Delay	Single-Click Step Decrement 	Enable OFF-Delay Decrement
	Press and Hold Rapid Decrement 	Step Decrement or Rapid Decrement

Q60LAF Series Laser Adjustable-Field Sensors

Sensor Setup

Light/Dark Operate

Light Operate or Dark Operate mode may be selected using the two push buttons or triple-click the remote line to toggle between the selections.

Push Button Lockout

For security, the push buttons may be locked out using either the remote line (for DC models only) or the push buttons themselves. Repeat the process to change the setting.

Laser Enable/Disable (DC models only)

Laser will be disabled after remote line is held low for 800 ms and will remain disabled until remote line is released.

NOTE: 500 ms max. delay after laser is enabled; outputs will default to "No Light" state.

	Push Button	Remote (DC models only) 0.04 sec. < T < 0.8 sec.
LO/DO Toggle		
Push Button Lockout Toggle		
Laser Enable/Disable	Not Available	

Q60LAF Series Laser Adjustable-Field Sensors

Laser Classifications

Class 1

Lasers that are safe under reasonably foreseeable conditions of operation, including the use of optical instruments for intrabeam viewing. Reference 60825-1 Amend. 2 © IEC:2001(E), section 8.2.

Class 2

Lasers that emit visible radiation in the wavelength range from 400 nm to 700 nm where eye protection is normally afforded by aversion responses, including the blink reflex. This reaction may be expected to provide adequate protection under reasonably foreseeable conditions of operation, including the use of optical instruments for intrabeam viewing.

Reference 60825-1 Amend. 2 © IEC:2001(E), section 8.2.

Class 2 Laser Safety Notes: Low-power lasers are, by definition, incapable of causing eye injury within the duration of the blink (aversion response) of 0.25 seconds. They also must emit only visible wavelengths (400 - 700 nm). Therefore, an ocular hazard can exist only if an individual overcomes their natural aversion to bright light and stares directly into the laser beam.

For safe laser use:

- Do not permit a person to stare at the laser from within the beam.
- Do not point the laser at a person's eye at close range.
- Terminate the beam emitted by a Class 2 laser product at the end of its useful path. Locate open laser beam paths either above or below eye level, where practical.

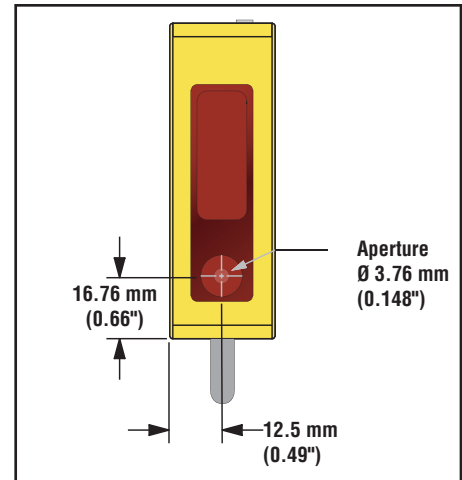

Figure 10. Laser aperture location



Caution

Use of controls or adjustments or performance of procedures other than those specified herein may result in hazardous radiation exposure; per EN 60825.

Do NOT attempt to disassemble this sensor for repair. A defective unit must be returned to the manufacturer.

Q60LAF Series Laser Adjustable-Field Sensors

Specifications

Supply Voltage and Current	Q60BB6LAF models: 10 to 30V dc (10% maximum ripple) at less than 35 mA exclusive of load Q60VR3LAF Universal models: 12 to 250V dc or 24 to 250V ac, 50/60 Hz Input power 1.5 W maximum
Supply Protection	Protected against reverse polarity and transient voltages (Q60VR3 models' dc hookup is without regard to polarity)
Output Configuration	Q60BB6LAF models: Bipolar; one NPN (current sinking) and one PNP (current sourcing) open-collector transistor Q60VR3LAF cabled model: E/M Relay (SPDT), normally closed and normally open contacts Q60VR3LAFQ1 (QD) model: E/M Relay (SPST), normally open contact
Output Rating	Q60BB6LAF models 150 mA maximum each output @ 25° C Off-state leakage current: < 5µA @ 30V dc Output saturation NPN: < 200 mV @ 10 mA and < 1V @150mA Output saturation PNP: < 1V at 10 mA; < 1.5V at 150 mA Q60VR3LAF Universal models Min. voltage and current: 5V dc, 10 mA Mechanical life of relay: 50,000,000 operations Electrical life of relay at full resistive load: 100,000 operations Max. switching power (resistive load): Cabled models: 1250VA, 150 W QD models: 750VA, 90W Max. switching voltage (resistive load): Cabled models: 250V ac, 125V dc QD models: 250V ac, 125V dc Max. switching current (resistive load): Cabled models: 5 A @ 250V ac, 5 A @ 30V dc derated to 200 mA @ 125V dc QD models: 3 A @ 250V ac, 3 A @ 30V dc derated to 200 mA @ 125V dc
Output Protection Circuitry	Q60BB6LAF models: Protected against continuous overload or short circuit of outputs All models: Protected against false pulse on power-up NOTE: 1 second max. delay at power up (outputs do not conduct during this time).
Output Response Time	Q60BB6LAF models: 2 milliseconds ON and OFF Q60VR3LAF Universal models: 15 milliseconds ON and OFF
Repeatability	500 microseconds
Sensing Hysteresis	See Figure 4.
Indicators (see Figure 1) NOTE: Outputs are active during on/off timing selection mode.	ON-Delay ON Green: RUN mode, ON-delay active Flashing Green: ON-Delay Selection mode OFF-Delay ON Green: RUN mode, OFF-delay active Flashing Green: OFF-Delay Selection mode 5-Segment Light Bar* ON/OFF-Delay Selection: Indicates relative delay time RUN Mode: Output ON Yellow: Outputs are conducting ON Green: ON/OFF-Delay Selection Dark Operate ON Green: Dark Operate selected Lockout ON Green: Buttons locked out Light Operate ON Green: Light Operate selected Signal ON Green: Sensor receiving signal Flashing Green: Marginal signal (1.0 to 2.25 excess gain)
Laser Characteristics	Spot Size: approximately 4 x 2 mm throughout range (collimated beam) Angle of Divergence: 5 milliradians NOTE: Contact factory for custom laser spot size.

Q60LAF Series Laser Adjustable-Field Sensors

Specifications, continued

Adjustments	Slotted, geared, 2-turn, cutoff range adjustment screw (mechanical stops on both ends of travel) 2 momentary push buttons: ON-Delay (+) and OFF-Delay (-) (DC models also have remote program wire) ON-Delay select: 8 ms to 16 seconds OFF-Delay select: 8 ms to 16 seconds LO/DO select Push button lockout for security Laser Enable/Disable (remote wire only)
Construction	Housing: ABS/polycarbonate Window: Acrylic
Environmental Rating	IEC IP67; NEMA 6
Connections	Q60BB6LAF (DC) models: 2 m (6.5') or 9 m (30') attached cable, 5-pin Euro-style integral QD fitting, or 5-pin Euro-style 150 mm (6") QD pigtail Q60VR3LAF Universal models: 2 m (6.5') or 9 m (30') attached cable, or 5-pin Micro-style 150 mm (6") QD fitting
Operating Conditions	Temperature: Q60BB6LAF (DC) models: -10° to +50°C (+14° to 121°F) Q60VR3LAF Universal models: -10° to +45°C (+14° to 113°F) Maximum Relative Humidity: 90% at 50°C (non-condensing)

Dimensions

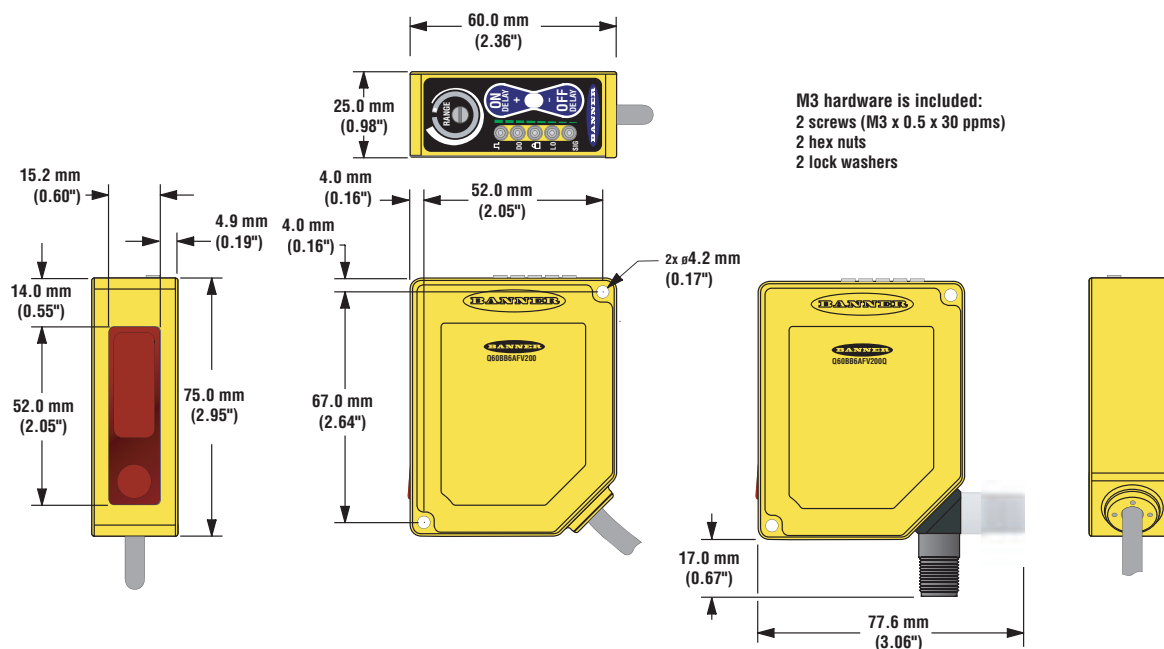

Q60LAF Series Laser Adjustable-Field Sensors

Hookups

DC Models
(Cabled, QD, and QP Models)

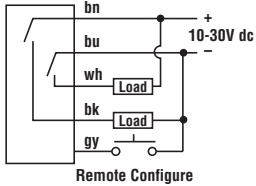

Universal Voltage Models
(Cabled Models)

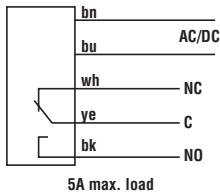

(QD Models)

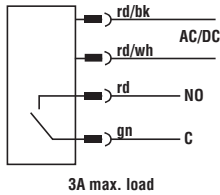

Quick-Disconnect (QD) Cables

5-pin Euro-style – DC Models

Model	Length	Connector	Pin-out
MQDC1-506 MQDC1-515 MQDC1-530	2 m (6.5') 5 m (15') 9 m (30')	Straight	<p>(cable connector shown)</p>
MQDC1-506RA MQDC1-515RA MQDC1-530RA	2 m (6.5') 5 m (15') 9 m (30')	Right-angle	

4-pin Micro-style – Universal Voltage Models

Model	Length	Connector	Pin-out
MQAC-406 MQAC-415 MQAC-430	2 m (6.5') 5 m (15') 9 m (30')	Straight	<p>(cable connector shown)</p>
MQAC-406RA MQAC-415RA MQAC-430RA	2 m (6.5') 5 m (15') 9 m (30')	Right-angle	

Q60LAF Series Laser Adjustable-Field Sensors

Accessory Bracket

SMBQ60

- Right-angle bracket
- 14-ga., 304 Stainless Steel

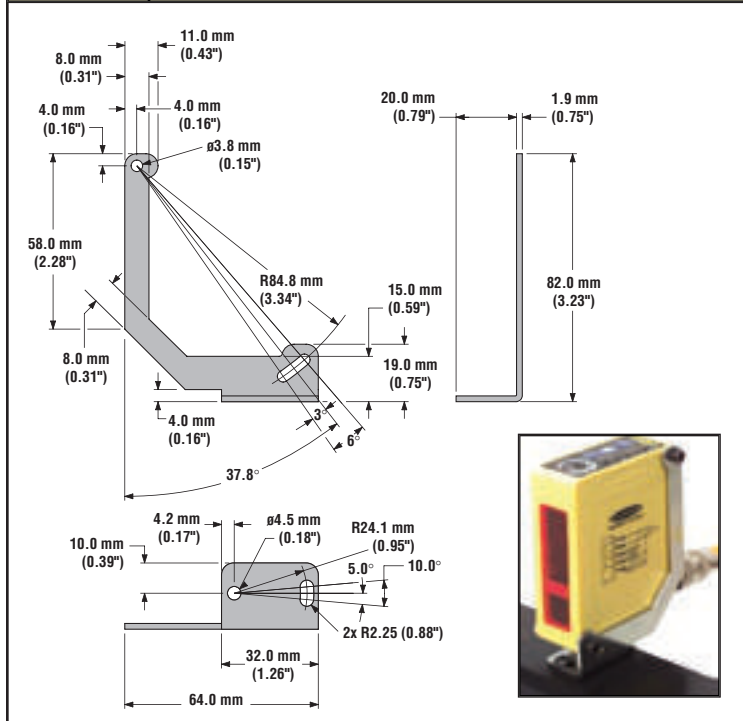

more sensors, more solutions



WARNING . . . Not To Be Used for Personnel Protection

Never use these products as sensing devices for personnel protection. Doing so could lead to serious injury or death.

These sensors do NOT include the self-checking redundant circuitry necessary to allow their use in personnel safety applications. A sensor failure or malfunction can cause either an energized or de-energized sensor output condition. Consult your current Banner Safety Products catalog for safety products which meet OSHA, ANSI and IEC standards for personnel protection.

WARRANTY: Banner Engineering Corp. warrants its products to be free from defects for one year. Banner Engineering Corp. will repair or replace, free of charge, any product of its manufacture found to be defective at the time it is returned to the factory during the warranty period. This warranty does not cover damage or liability for the improper application of Banner products. This warranty is in lieu of any other warranty either expressed or implied.

Q60LAF Series Laser Adjustable-Field Sensors

Long-Range Self-Contained Adjustable-Field Laser Sensors

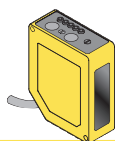

Features

- Long-range adjustable-field background suppression sensor detects objects within a defined sensing field, and ignores objects located beyond the sensing field cutoff
- Powerful visible red laser sensing beam, class 1 and class 2 models available
- Two-turn, logarithmic cutoff point adjustment for easy setting of cutoff point at long range; rotating pointer indicates relative cutoff point setting
- Easy push-button or remote setting of light/dark operate and output timing; continuous status indicators verify all settings at a glance
- Output ON and/or OFF delays adjustable from 8 milliseconds to 16 seconds
- Tough ABS/polycarbonate blend housing is rated IEC IP67; NEMA 6
- Models available for 10-30V dc operation or universal voltage (12 to 250V dc or 24 to 250V ac, 50/60 Hz)

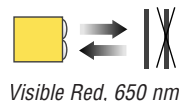

Visible Red, 650 nm

Models

Models	Cutoff Point	Cable*	Supply Voltage	Output Type	Excess Gain (performance based on 90% reflectance white test card)
Class 1 Laser					
Q60BB6LAF1400	Adjustable: 200 mm to 1400 mm (8" to 55")	5-wire 2 m (6.5')	10 to 30V dc	Bipolar NPN/PNP	
Q60BB6LAF1400Q		5-pin Euro-style QD fitting			
Q60BB6LAF1400QP		5-pin Euro-style QD pigtail			
Q60VR3LAF1400		5-wire 2 m (6.5')	Universal Voltage 12 to 250V dc or 24 to 250V ac	E/M Relay (SPDT), N.C. and N.O. contacts	
Q60VR3LAF1400Q1		4-pin Micro-style QD fitting			
Class 2 Laser					
Q60BB6LAF2000	Adjustable: 200 mm to 2000 mm (8" to 80")	5-wire 2 m (6.5')	10 to 30V dc	Bipolar NPN/PNP	
Q60BB6LAF2000Q		5-pin Euro-style QD fitting			
Q60BB6LAF2000QP		5-pin Euro-style QD pigtail			
Q60VR3LAF2000		5-wire 2 m (6.5')	Universal Voltage 12 to 250V dc or 24 to 250V ac	E/M Relay (SPDT), N.C. and N.O. contacts	
Q60VR3LAF2000Q1		4-pin Micro-style QD fitting			

* 9 meter cables are available by adding suffix "W/30" to the model number of any cabled sensor (e.g., Q60BB6LAF1400 W/30). A model with a QD connector requires a mating cable; see page 8.

See Safety Use Warning on back page.

Q60LAF Series Laser Adjustable-Field Sensors

Overview

The Q60LAF sensor is a full-featured adjustable-field sensor. These adjustable-field sensors are able to detect objects of relatively low reflectivity, while ignoring other objects in the background (beyond the cutoff point). The cutoff distance is mechanically adjustable, using the 2-turn adjustment screw (Figure 1). A rotating pointer indicates the relative cutoff position. (The indicator moves clockwise to show increasing distance.) The collimated laser emitter produces a small, bright spot, allowing easy alignment and precision sensing of relatively small objects at long range.

Two push buttons (ON Delay and OFF Delay) are used to set the output delay options, to toggle between light and dark operate modes and to lock out the push buttons for security purposes. For 10 to 30V dc models, these functions also may be accomplished using the remote wire.

Seven LED indicators show, during RUN mode, the sensor configuration and operating status. During Delay Configuration, 5 of the LEDs combine to form a single light bar that indicates relative ON or OFF delay time.

Adjustable-Field Sensing – Theory of Operation

In operation, the Q60LAF compares the reflections of its emitted light beam (E) from an object back to the sensor's two differently-aimed detectors R1 and R2 (see Figure 2). If the near detector (R1) light signal is stronger than the far detector (R2) light signal (see object A, closer than the cutoff distance), the sensor responds to the object. If the far detector (R2) light signal is stronger than the near detector (R1) light signal (see object B, object beyond the cutoff distance), the sensor ignores the object.

The cutoff distance for Q60LAF sensors is adjustable from 200 to 1400 mm (8" to 55") for Class 1 laser models, and 200 to 2000 mm (8" to 80") for Class 2 laser models. Objects lying beyond the cutoff distance are ignored.

In the drawings and discussion on this page and page 4, the letters E, R1, and R2 identify how the sensor's three optical elements (Emitter "E", Near Detector "R1", and Far Detector "R2") line up across the face of the sensor. The location of these elements defines the sensing axis (see Figure 3). The sensing axis becomes important in certain situations, such as those illustrated in Figures 7 and 8.

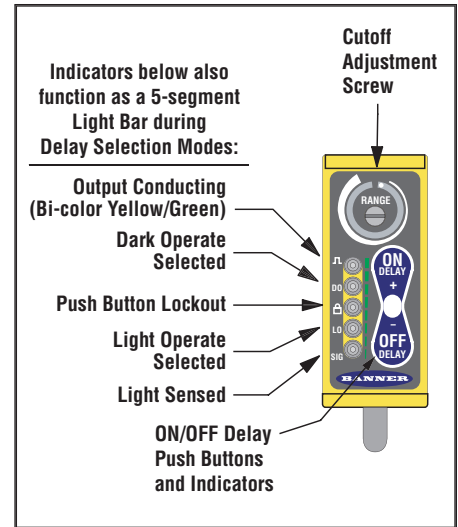

Figure 1. Q60LAF features

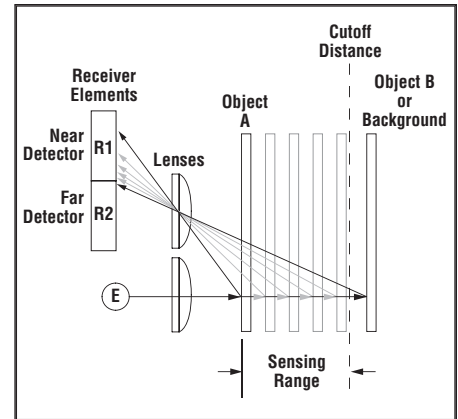

Figure 2. Adjustable field sensing concept

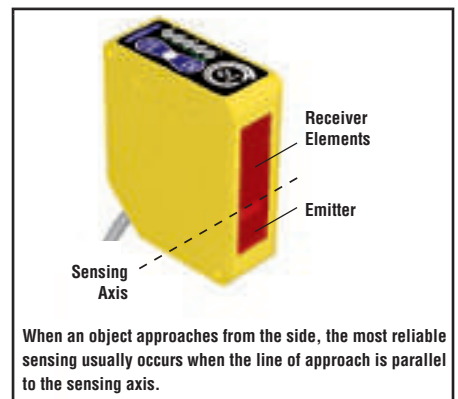

Figure 3. Q60 sensing axis

Q60LAF Series Laser Adjustable-Field Sensors

Color Sensitivity

The effects of object reflectivity on cutoff distance, though small, may be important for some applications.

The excess gain curves on page 1 were generated using a white test card of 90% reflectance. Objects with reflectivity of less than 90% reflect less light back to the sensor, and thus require proportionately more excess gain in order to be sensed with the same reliability as more reflective objects. When sensing an object of very low reflectivity, it may be especially important to sense it at or near the distance of maximum excess gain.

It is expected that at any given cutoff setting, the actual cutoff distance for lower reflectance targets will be slightly shorter than for higher reflectance targets (see Figure 4). This behavior is known as color sensitivity.

The percentage of deviation indicates a change in the cutoff point for either 18% gray or 6% black targets, relative to the cutoff point set for a 90% reflective white test card.

For example, the cutoff point decreases 10% for a 6% reflectance black target when the cutoff point is adjusted for 1700 mm (67") using a 90% reflectance white test card. In other words, the cutoff point for the black target is 1530 mm (60") for this setting.

NOTE: Sensing at closer than the minimum specified range is not guaranteed.

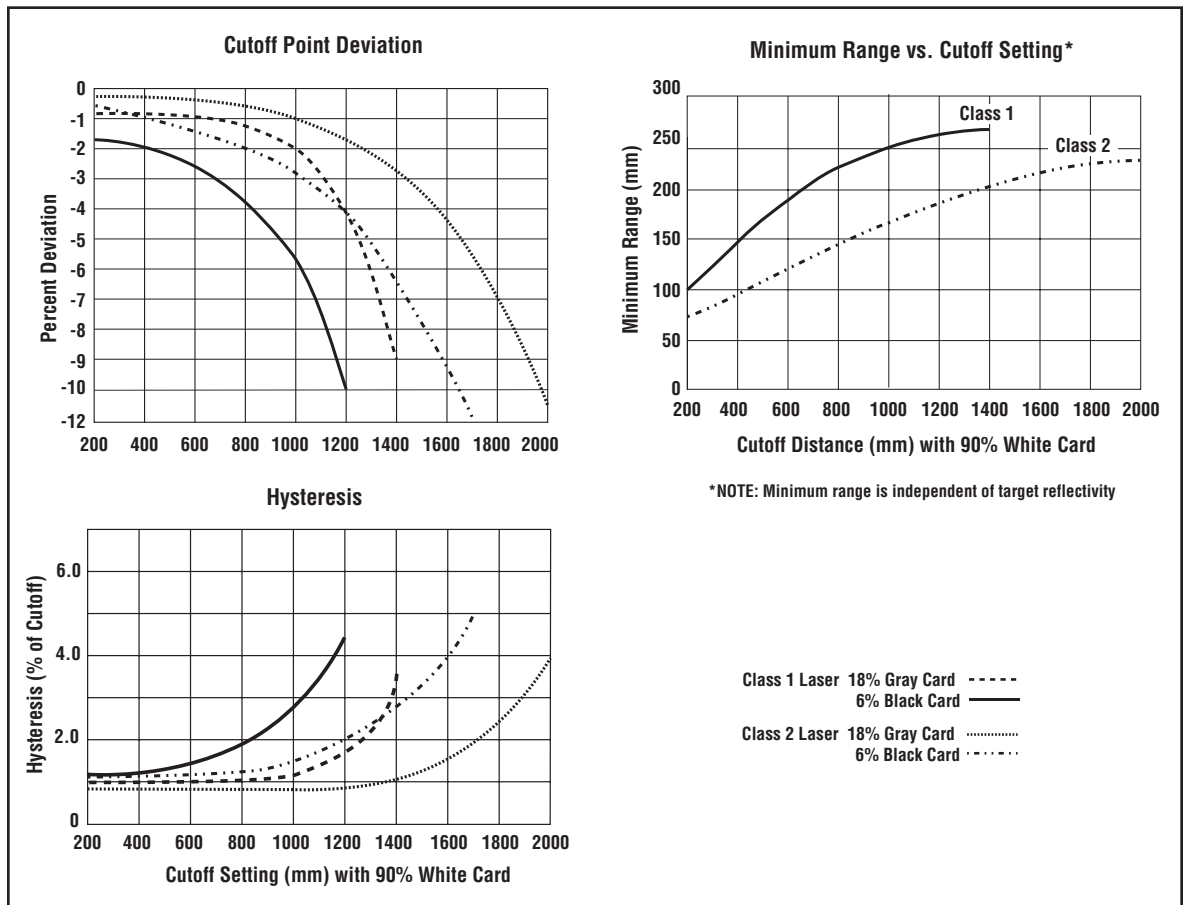

Figure 4. Q60LAF performance

Q60LAF Series Laser Adjustable-Field Sensors

Setting the Cutoff Distance

The cutoff distance for Q60LAF sensors may be adjusted between 200 mm and 1400 mm (8" to 55") for Class 1 laser models, and between 200 mm and 2000 mm (8" to 80") for Class 2 laser models.

To maximize contrast, position the lightest possible background to be used, at the closest position it will come to the sensor during use (Figure 5). Using a small screwdriver in the adjustment screw, adjust the cutoff distance until the threshold is reached and the green Light Sensed indicator changes state. (If the indicator never comes ON, the background is beyond the maximum sensing cutoff and will be ignored.) Note the position of the rotating cutoff position indicator at this position. Then repeat the procedure, using the darkest target, placed in its most distant position for sensing. Adjust the cutoff so that the indicator is midway between the two positions (Figure 6).

NOTE: Setting the cutoff distance adjustment screw to its maximum clockwise position places the receiver lens directly in front of the receiver elements and results in the Q60 performing as a long-range diffuse sensor.

Sensing Reliability

For highest sensitivity, the sensor should be mounted so that the target object will be sensed at or near the point of maximum excess gain. The excess gain curves on page 1 show excess gain vs. sensing distance for 200 mm, 1,200 mm and 2 m cutoffs. Maximum excess gain for a 200 mm cutoff occurs at a lens-to-object distance of about 150 mm, and for a 2 m cutoff, at about 500 mm. The background must be placed beyond the cutoff distance. Following these two guidelines makes it possible to detect objects of low reflectivity, even against close-in reflective backgrounds.

Background Reflectivity and Placement

Avoid mirror-like backgrounds that produce specular reflections. False sensor response will occur if a background surface reflects the sensor's light more strongly to the near detector (R1) than to the far detector (R2). The result is a false ON condition (Figure 7). Use of a diffusely-reflective (matte) background will cure this problem. Other possible solutions are to angle either the sensor or the background (in any plane) so that the background does not reflect back to the sensor.

An object beyond the cutoff distance, either moving or stationary (and when positioned as shown in Figure 8), can cause unwanted triggering of the sensor because it reflects more light to the near detector than to the far detector. The problem is easily remedied by rotating the sensor 90° to align the sensing axis horizontally. The object then reflects the R1 and R2 fields equally, resulting in no false triggering.

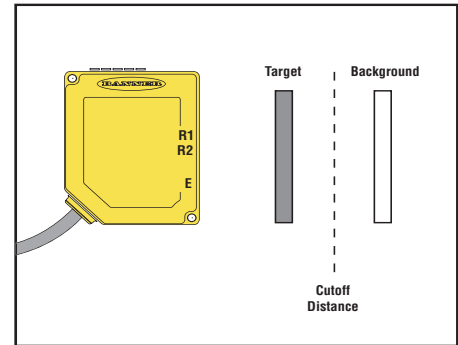

Figure 5. Set cutoff distance approximately midway between the farthest target and the closest background

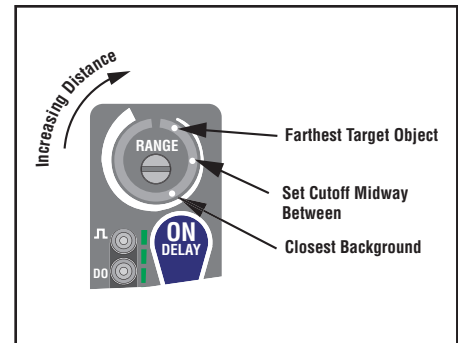

Figure 6. Setting the cutoff distance

Q60LAF Series Laser Adjustable-Field Sensors

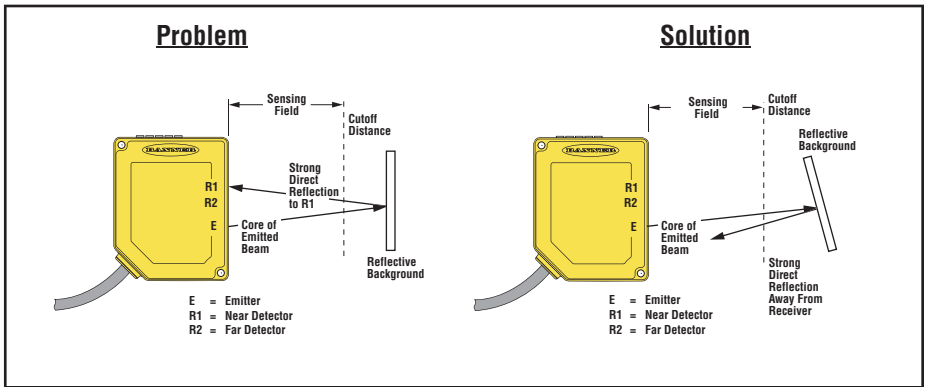

Figure 7. Reflective background – problem and solution

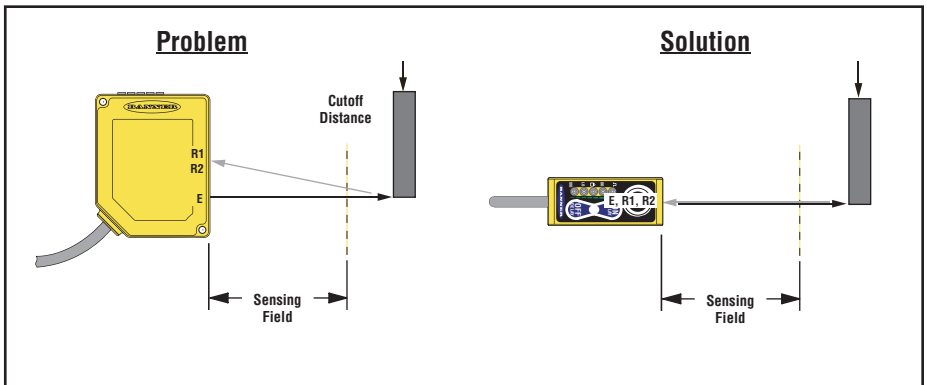

Figure 8. Object beyond cutoff distance — problem and solution

Q60LAF Series Laser Adjustable-Field Sensors

Setting the Output Delay

When target objects are in motion, an output delay can help prevent “hunting” or multiple outputs from process control equipment. A delay also can be used to monitor product flow, “downed goods”, or “jams” (product that is no longer being conveyed properly). A delay can also create a “smart zone,” enabling certain equipment to be directly controlled by the sensor, rather than requiring a PLC I/O.

The Q60LAF output may be delayed from 0.008 to 16 seconds, in 72 increments. Delay is indicated on the 5-segment light bar using single LED segments or combinations of them, in varying stages of intensity; see Figure 9.

To set a delay, single-click the appropriate button or pulse the remote wire (DC models only) to enable the process. Then use the + or – button or the appropriate remote wire pulses to increase or decrease the delay (single-click to adjust the delay by one step, or hold the button for a rapid increase/decrease).

Step Number	Delay Time (Seconds)	LED Status
0	No Delay	
8	0.062	
24	0.25	
40	1.0	
56	4.0	
72	16	

Figure 9. ON/OFF Delay options (major increments depicted)

Output ON-Delay – 4 second time-out		
	Push Button	Remote (DC models only) 0.04 sec. < T < 0.8 sec.
Enter ON-Delay Setup	Single-Click 	
Increase ON-Delay	Single-Click Step Increment 	Enable ON-Delay Increment
	Press and Hold Rapid Increment 	Step Increment or Rapid Increment
Decrease ON-Delay	Single-Click Step Decrement 	Enable ON-Delay Decrement
	Press and Hold Rapid Decrement 	Step Decrement or Rapid Decrement

Output OFF-Delay – 4 second time-out		
	Push Button	Remote (DC models only) 0.04 sec. < T < 0.8 sec.
Enter OFF-Delay Setup	Single-Click 	
Increase OFF-Delay	Single-Click Step Increment 	Enable OFF-Delay Increment
	Press and Hold Rapid Increment 	Step Increment or Rapid Increment
Decrease OFF-Delay	Single-Click Step Decrement 	Enable OFF-Delay Decrement
	Press and Hold Rapid Decrement 	Step Decrement or Rapid Decrement

Q60LAF Series Laser Adjustable-Field Sensors

Sensor Setup

Light/Dark Operate

Light Operate or Dark Operate mode may be selected using the two push buttons or triple-click the remote line to toggle between the selections.

Push Button Lockout

For security, the push buttons may be locked out using either the remote line (for DC models only) or the push buttons themselves. Repeat the process to change the setting.

Laser Enable/Disable (DC models only)

Laser will be disabled after remote line is held low for 800 ms and will remain disabled until remote line is released.

NOTE: 500 ms max. delay after laser is enabled; outputs will default to "No Light" state.

	Push Button	Remote (DC models only) 0.04 sec. < T < 0.8 sec.
LO/DO Toggle		
Push Button Lockout Toggle		
Laser Enable/Disable	Not Available	

Q60LAF Series Laser Adjustable-Field Sensors

Laser Classifications

Class 1

Lasers that are safe under reasonably foreseeable conditions of operation, including the use of optical instruments for intrabeam viewing. Reference 60825-1 Amend. 2 © IEC:2001(E), section 8.2.

Class 2

Lasers that emit visible radiation in the wavelength range from 400 nm to 700 nm where eye protection is normally afforded by aversion responses, including the blink reflex. This reaction may be expected to provide adequate protection under reasonably foreseeable conditions of operation, including the use of optical instruments for intrabeam viewing.

Reference 60825-1 Amend. 2 © IEC:2001(E), section 8.2.

Class 2 Laser Safety Notes: Low-power lasers are, by definition, incapable of causing eye injury within the duration of the blink (aversion response) of 0.25 seconds. They also must emit only visible wavelengths (400 - 700 nm). Therefore, an ocular hazard can exist only if an individual overcomes their natural aversion to bright light and stares directly into the laser beam.

For safe laser use:

- Do not permit a person to stare at the laser from within the beam.
- Do not point the laser at a person's eye at close range.
- Terminate the beam emitted by a Class 2 laser product at the end of its useful path. Locate open laser beam paths either above or below eye level, where practical.

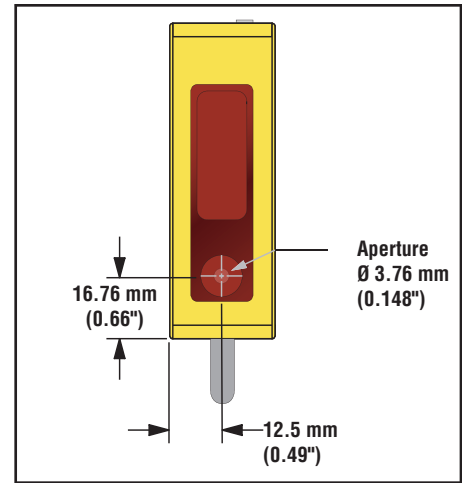

Figure 10. Laser aperture location



Caution

Use of controls or adjustments or performance of procedures other than those specified herein may result in hazardous radiation exposure; per EN 60825.

Do NOT attempt to disassemble this sensor for repair. A defective unit must be returned to the manufacturer.

Q60LAF Series Laser Adjustable-Field Sensors

Specifications

Supply Voltage and Current	Q60BB6LAF models: 10 to 30V dc (10% maximum ripple) at less than 35 mA exclusive of load Q60VR3LAF Universal models: 12 to 250V dc or 24 to 250V ac, 50/60 Hz Input power 1.5 W maximum
Supply Protection	Protected against reverse polarity and transient voltages (Q60VR3 models' dc hookup is without regard to polarity)
Output Configuration	Q60BB6LAF models: Bipolar; one NPN (current sinking) and one PNP (current sourcing) open-collector transistor Q60VR3LAF cabled model: E/M Relay (SPDT), normally closed and normally open contacts Q60VR3LAFQ1 (QD) model: E/M Relay (SPST), normally open contact
Output Rating	Q60BB6LAF models 150 mA maximum each output @ 25° C Off-state leakage current: < 5µA @ 30V dc Output saturation NPN: < 200 mV @ 10 mA and < 1V @150mA Output saturation PNP: < 1V at 10 mA; < 1.5V at 150 mA Q60VR3LAF Universal models Min. voltage and current: 5V dc, 10 mA Mechanical life of relay: 50,000,000 operations Electrical life of relay at full resistive load: 100,000 operations Max. switching power (resistive load): Cabled models: 1250VA, 150 W QD models: 750VA, 90W Max. switching voltage (resistive load): Cabled models: 250V ac, 125V dc QD models: 250V ac, 125V dc Max. switching current (resistive load): Cabled models: 5 A @ 250V ac, 5 A @ 30V dc derated to 200 mA @ 125V dc QD models: 3 A @ 250V ac, 3 A @ 30V dc derated to 200 mA @ 125V dc
Output Protection Circuitry	Q60BB6LAF models: Protected against continuous overload or short circuit of outputs All models: Protected against false pulse on power-up NOTE: 1 second max. delay at power up (outputs do not conduct during this time).
Output Response Time	Q60BB6LAF models: 2 milliseconds ON and OFF Q60VR3LAF Universal models: 15 milliseconds ON and OFF
Repeatability	500 microseconds
Sensing Hysteresis	See Figure 4.
Indicators (see Figure 1) NOTE: Outputs are active during on/off timing selection mode.	ON-Delay ON Green: RUN mode, ON-delay active Flashing Green: ON-Delay Selection mode OFF-Delay ON Green: RUN mode, OFF-delay active Flashing Green: OFF-Delay Selection mode 5-Segment Light Bar* ON/OFF-Delay Selection: Indicates relative delay time RUN Mode: Output ON Yellow: Outputs are conducting ON Green: ON/OFF-Delay Selection Dark Operate ON Green: Dark Operate selected Lockout ON Green: Buttons locked out Light Operate ON Green: Light Operate selected Signal ON Green: Sensor receiving signal Flashing Green: Marginal signal (1.0 to 2.25 excess gain)
Laser Characteristics	Spot Size: approximately 4 x 2 mm throughout range (collimated beam) Angle of Divergence: 5 milliradians NOTE: Contact factory for custom laser spot size.

Q60LAF Series Laser Adjustable-Field Sensors

Specifications, continued

Adjustments	Slotted, geared, 2-turn, cutoff range adjustment screw (mechanical stops on both ends of travel) 2 momentary push buttons: ON-Delay (+) and OFF-Delay (-) (DC models also have remote program wire) ON-Delay select: 8 ms to 16 seconds OFF-Delay select: 8 ms to 16 seconds LO/DO select Push button lockout for security Laser Enable/Disable (remote wire only)
Construction	Housing: ABS/polycarbonate Window: Acrylic
Environmental Rating	IEC IP67; NEMA 6
Connections	Q60BB6LAF (DC) models: 2 m (6.5') or 9 m (30') attached cable, 5-pin Euro-style integral QD fitting, or 5-pin Euro-style 150 mm (6") QD pigtail Q60VR3LAF Universal models: 2 m (6.5') or 9 m (30') attached cable, or 5-pin Micro-style 150 mm (6") QD fitting
Operating Conditions	Temperature: Q60BB6LAF (DC) models: -10° to +50°C (+14° to 121°F) Q60VR3LAF Universal models: -10° to +45°C (+14° to 113°F) Maximum Relative Humidity: 90% at 50°C (non-condensing)

Dimensions

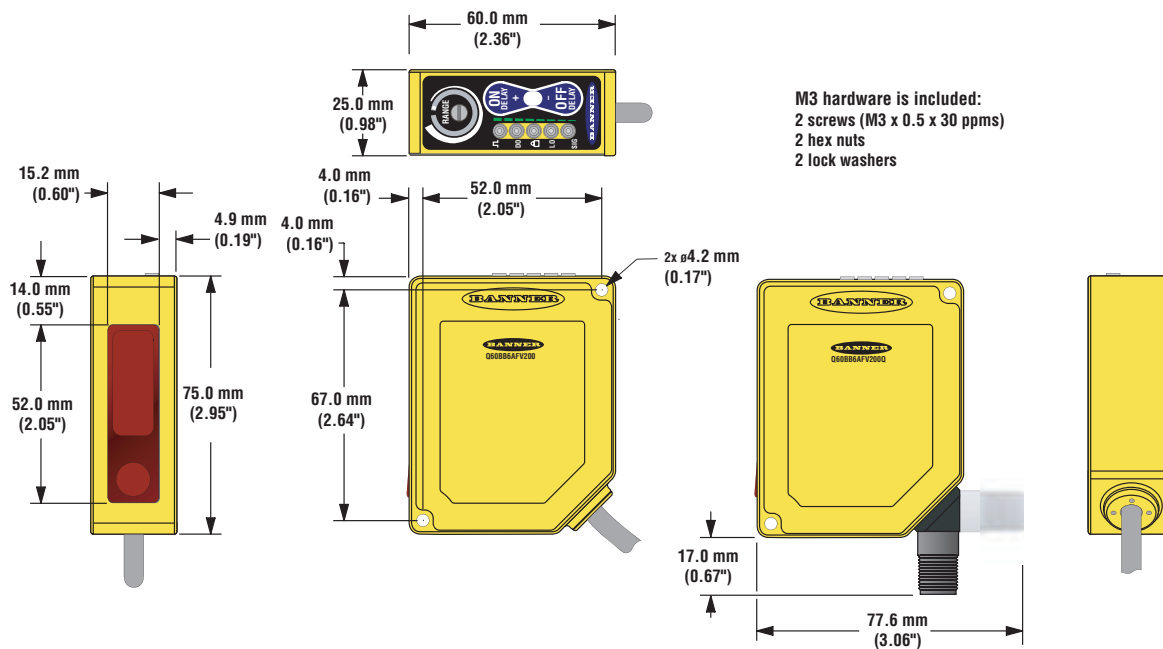

Q60LAF Series Laser Adjustable-Field Sensors

Hookups

DC Models
(Cabled, QD, and QP Models)

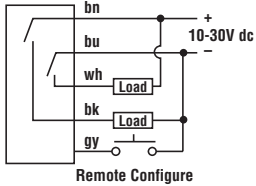

Universal Voltage Models
(Cabled Models)

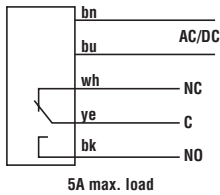

(QD Models)

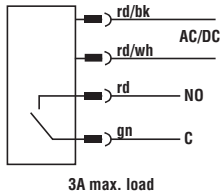

Quick-Disconnect (QD) Cables

5-pin Euro-style – DC Models

Model	Length	Connector	Pin-out
MQDC1-506 MQDC1-515 MQDC1-530	2 m (6.5') 5 m (15') 9 m (30')	Straight	<p>(cable connector shown)</p>
MQDC1-506RA MQDC1-515RA MQDC1-530RA	2 m (6.5') 5 m (15') 9 m (30')	Right-angle	

4-pin Micro-style – Universal Voltage Models

Model	Length	Connector	Pin-out
MQAC-406 MQAC-415 MQAC-430	2 m (6.5') 5 m (15') 9 m (30')	Straight	<p>(cable connector shown)</p>
MQAC-406RA MQAC-415RA MQAC-430RA	2 m (6.5') 5 m (15') 9 m (30')	Right-angle	

Q60LAF Series Laser Adjustable-Field Sensors

Accessory Bracket

SMBQ60

- Right-angle bracket
- 14-ga., 304 Stainless Steel

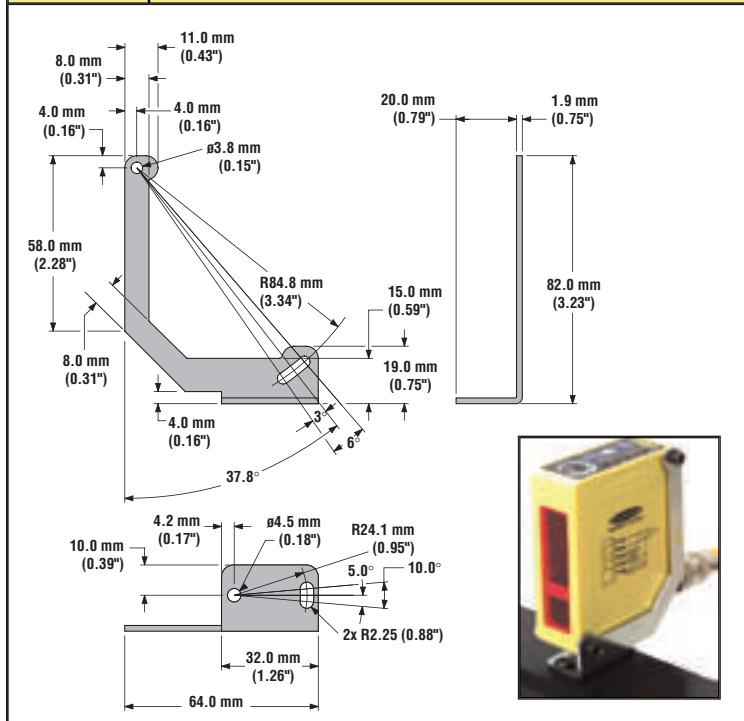

more sensors, more solutions



WARNING . . . Not To Be Used for Personnel Protection

Never use these products as sensing devices for personnel protection. Doing so could lead to serious injury or death.

These sensors do NOT include the self-checking redundant circuitry necessary to allow their use in personnel safety applications. A sensor failure or malfunction can cause either an energized or de-energized sensor output condition. Consult your current Banner Safety Products catalog for safety products which meet OSHA, ANSI and IEC standards for personnel protection.

WARRANTY: Banner Engineering Corp. warrants its products to be free from defects for one year. Banner Engineering Corp. will repair or replace, free of charge, any product of its manufacture found to be defective at the time it is returned to the factory during the warranty period. This warranty does not cover damage or liability for the improper application of Banner products. This warranty is in lieu of any other warranty either expressed or implied.