



## RIGD SINGLE PIECE STRUT CLAMP FOR PIPE/RIGID CONDUIT, STEEL, EG, 3" PIPE, 3.5" OD

### CATALOG NUMBER

**RIGD0300EG**



### CERTIFICATIONS



### FEATURES

One piece break apart strut clamp (1/2" thru 4" pipe size)

Includes thread impression and captured screw (1/2" thru 4" pipe size)

Fits into open side of strut channel

Conforms with Manufacturers Standardization Society (MSS) SP-58 (Type 59)

### PRODUCT ATTRIBUTES

Material: Steel

Finish: Electrogalvanized

Pipe Size: 3"

Outer Diameter (OD): 3 1/2"

Width (W): 1 1/4"

Thickness (T): 12ga

Static Load (F): 800lb

## DIAGRAMS

---

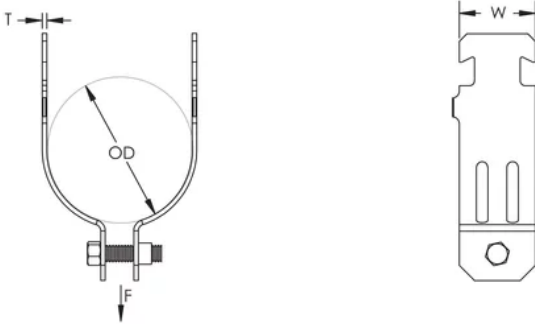

## WARNING

---

nVent products shall be installed and used only as indicated in nVent's product instruction sheets and training materials. Instruction sheets are available at [www.nvent.com](http://www.nvent.com) and from your nVent customer service representative. Improper installation, misuse, misapplication or other failure to completely follow nVent's instructions and warnings may cause product malfunction, property damage, serious bodily injury and death and/or void your warranty.

### North America

+1.800.753.9221  
Option 1 – Customer Care  
Option 2 – Technical Support

### Europe

Netherlands:  
+31 800-0200135  
France:  
+33 800 901 793

### Europe

Germany:  
800 1890272  
Other Countries:  
+31 13 5835404

### APAC

Shanghai:  
+ 86 21 2412 1618/19  
Sydney:  
+61 2 9751 8500



Our powerful portfolio of brands:  
**nVent.com CADDY ERICO HOFFMAN RAYCHEM SCHROFF**  
**TRACER**

© 2024 nVent. All nVent marks and logos are owned or licensed by nVent Services GmbH or its affiliates. All other trademarks are the property of their respective owners.

nVent reserves the right to change specifications without notice.



## RIGD SINGLE PIECE STRUT CLAMP FOR PIPE/RIGID CONDUIT, STEEL, EG, 3" PIPE, 3.5" OD

### CATALOG NUMBER

**RIGD0300EG**



### CERTIFICATIONS



### FEATURES

One piece break apart strut clamp (1/2" thru 4" pipe size)

Includes thread impression and captured screw (1/2" thru 4" pipe size)

Fits into open side of strut channel

Conforms with Manufacturers Standardization Society (MSS) SP-58 (Type 59)

### PRODUCT ATTRIBUTES

Material: Steel

Finish: Electrogalvanized

Pipe Size: 3"

Outer Diameter (OD): 3 1/2"

Width (W): 1 1/4"

Thickness (T): 12ga

Static Load (F): 800lb

## DIAGRAMS

---

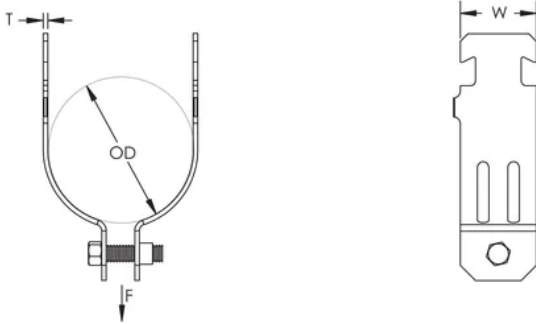

## WARNING

---

nVent products shall be installed and used only as indicated in nVent's product instruction sheets and training materials. Instruction sheets are available at [www.nvent.com](http://www.nvent.com) and from your nVent customer service representative. Improper installation, misuse, misapplication or other failure to completely follow nVent's instructions and warnings may cause product malfunction, property damage, serious bodily injury and death and/or void your warranty.

### North America

+1.800.753.9221  
Option 1 – Customer Care  
Option 2 – Technical Support

### Europe

Netherlands:  
+31 800-0200135  
France:  
+33 800 901 793

### Europe

Germany:  
800 1890272  
Other Countries:  
+31 13 5835404

### APAC

Shanghai:  
+ 86 21 2412 1618/19  
Sydney:  
+61 2 9751 8500



Our powerful portfolio of brands:  
**nVent.com CADDY ERICO HOFFMAN RAYCHEM SCHROFF**  
**TRACER**

© 2024 nVent. All nVent marks and logos are owned or licensed by nVent Services GmbH or its affiliates. All other trademarks are the property of their respective owners.

nVent reserves the right to change specifications without notice.