

**Description**

The Halo RL560 is a complete LED Baffle-Trim Module for 5" and 6" aperture recessed downlights; suitable for new construction, remodel and retrofit installation. The RL560 is cULus Listed for use with Halo and All-Pro, and is UL Classified for use with other compatible 5" and 6" housings. The RL560 with integral LED driver offers 120 volt dimming capability. The RL560 lens provides uniform illumination and wet location listing. Precision construction makes any housing AIR-TITE for added HVAC savings and code compliance. Compliant with NFPA 70, NEC section 410.16 (A)(1) and 410.16 (C)(3).

Catalog #		Type
Project		
Comments		Date
Prepared by		

**Specification Features**

**MECHANICAL**

**Module - Trim**

- Module construction includes LED, heat sink, reflector, lens, baffle and trim ring
- Regressed baffle
- Heat sink designed to conduct heat away from the LED keeping the junction temperatures below specified maximums, even when installed in insulated ceiling environments. L70 at 50,000 hours.
- Designer trim finish options (sold separately)
  - White (Paintable) Trim Ring
  - Satin Nickel Trim Ring
  - Tuscan Bronze Trim Ring

**Lens**

- Regressed lens
- Impact-resistant polycarbonate
- Convex form for lamp-like appearance
- High lumen transmission
- Diffusing for even illumination

**Mounting**

- Integral torsion springs and Push-N-Twist clips offer two mounting options
  - Torsion springs are pre-installed and adjust to fit 5" or 6" compatible housings
  - Push-N-Twist universal installation clips are pre-installed and designed to fit 5" or 6" compatible housings

**Housing Compatibility**

See Housing Compatibility

**LED**

- Color Temperature (CCT)\* Options:
  - 90 CRI: 2700K, 3000K, 3500K, 4000K, and 5000K
- Can be used to comply with California Title 24 High Efficacy requirements. Certified to California Appliance Efficiency Database under JAB.

**LED Chromaticity**

- A tight chromaticity specification ensures LED color uniformity, sustainable Color Rendering Index (CRI) and Correlated Color Temperature (CCT) over the useful life of the LED
- LED chromaticity of 3 SDCM exceeds ENERGY STAR® color standards per ANSI C78.377-2008

- High color performance with R9 greater than 50
- Every Halo LED is quality tested, measured, and serialized in a permanent record to register lumens, wattage, CRI and CCT
- Halo LED serialized testing and measurement ensures color and lumen consistency on a per-unit basis, and validates long-term product consistency over time

**ELECTRICAL**

**Power Connections**

- LED connector is a non-screw base luminaire disconnect offering easy installation with the matching Halo 5" and 6" LED housings
- LED Connector meets California Title-24 high efficacy luminaire requirement for a non-screw base socket, and where required to qualify as a high efficacy luminaire
- The included E26 medium screw-base Edison adapter provides easy retrofit of incandescent housings (see Housing Compatibility)

**Ground Connection**

Separate grounding cable included on the module for attachment to the housing during installation.

**LED Driver**

- Dimmable driver is a 120 Volt, high efficiency, electronic power supply providing DC power to the LED
- Driver meets FCC EMI/RFI Consumer Level limits for use in residential and commercial installations

- Driver features high power factor, low THD, and has integral thermal protection in the event of over temperature or internal failure

**Dimming**

- Designed for continuous dimming capability to nominally 5% with many 120V Leading Edge (LE) and Trailing Edge (TE) Phase Control dimmers. (Dimmers with low end trim adjustment offer greater assurance of achieving 5% level.)
- Consult dimmer manufacturer for compatibility and conditions of use

**Note:** some dimmers require a neutral in the wallbox.

**Warranty**

Eaton provides a five year limited warranty on RL56 LED.

**Compliance Labels**

- UL Certified 1598 Luminaire with Halo housings and others - see Housing Compatibility
- UL Certified for Damp Location
- IP56 Ingress Protection rated
- May be installed in housings in direct contact with insulation\*\* and combustible material

**Compliance**

- Airtight certified per ASTM E283 (not exceeding 2.0 CFM under 75 Pascals pressure difference)
- 90 CRI: Can be used to comply with California Title 24 High Efficacy requirements. Certified to California Title 20 Appliance Efficiency Database.\*
- 80 CRI: Can be used to comply with California Title 24 Non-Residential Lighting Controls requirements as an LED luminaire
- Can be used for International Energy Conservation Code (IECC) high efficiency luminaire compliance
- Can be used for Washington State Energy Code compliance
- ENERGY STAR® Certified luminaire - consult ENERGY STAR® Certified Product List\*
- EMI/RFI per FCC 47CFR Part 15 Class B Consumer limits, suitable for use in residential and commercial installations
- Contains no mercury or lead and RoHS compliant
- Photometric testing in accordance with IES LM-79
- Lumen maintenance projections in accordance with IES LM-80 and TM-21
- Suitable for use in closets. Compliant with NFPA 70, NEC Sec. 410.16 (A)(1) and 410.16 (C)(3).



**RL560WH9<sup>†</sup>**

White

**900 Series  
5/6-Inch LED  
Recessed Retrofit  
Module-Trim**

**90CRI  
2700K, 3000K, 3500K,  
4000K, 5000K**

**FOR USE IN  
INSULATED CEILING  
AND NON- INSULATED  
CEILING RATED  
HOUSINGS**

**HIGH EFFICACY LED  
WITH INTEGRAL  
DRIVER - DIMMABLE**



Refer to ENERGY STAR® Qualified Products List.  
Can be used to comply with California Title 24 High Efficacy requirements.  
Certified to California Appliance Efficiency Database under JAB.

\* Refer to ENERGY STAR® Certified Products List and CEC (T20) Appliance Database for listings.  
\*\* Not for use with housings in direct contact with spray foam insulation.  
† See ordering information table for available models.

**RL56 Dimensions**

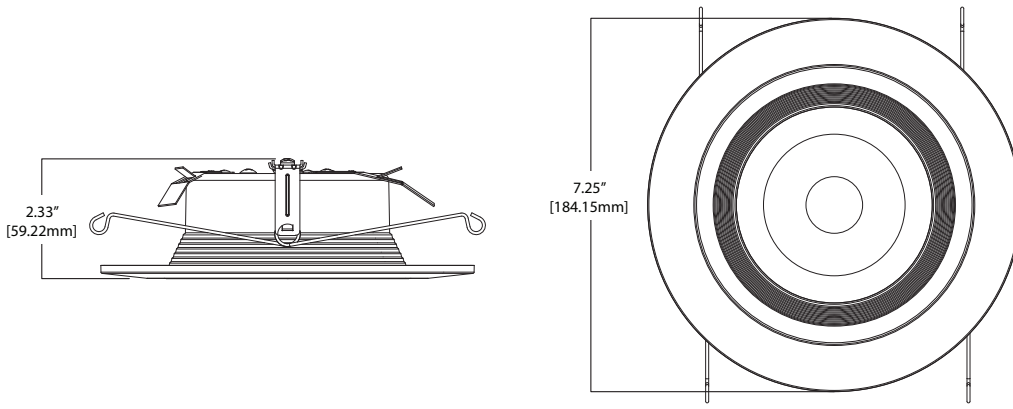

**Designer Trim Dimensions**

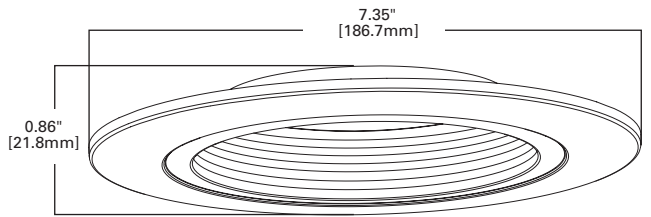

**RL56TRMWHB**  
White (Paintable)

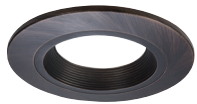

**RL56TRMTBZB**  
Tuscan Bronze



**RL56TRMSNB**  
Satin Nickel

**Energy Data**

**RL56 Series** (Values at non-dimming line voltage)

Minimum Starting Temp: -30°C (-22°F)
EMI/RFI: FCC Title 47 CFR, Part 15, Class B (Consumer)
Sound Rating: Class A
Input Voltage: 120V
Power Factor: >0.90
Input Frequency: 60Hz
THD: <20%
Input Power: 13.5W
Input Current: 0.15A
Maximum IC (Insulated Ceiling) Ambient Continuous Operating Temperature: 25°C (77°F)
Maximum Non-IC Ambient Continuous Operating Temperature 40°C (104°F)

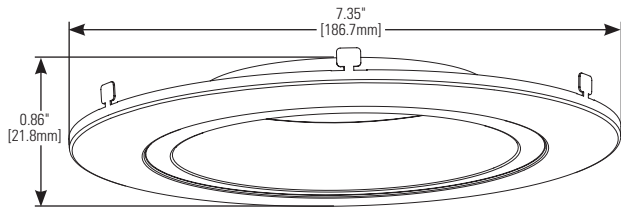

**RL56TRMWH**  
White (Paintable)

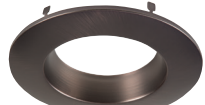

**RL56TRMTBZ**  
Tuscan Bronze



**RL56TRMSN**  
Satin Nickel

**Ordering Information**

Sample Number: **RL560WH9927-RL56TRMSNB**

Complete unit includes a RL56 Baffle-Trim LED Module and a 5" and 6" compatible housing (ordered separately). Optional accessory designer trim ring ordered separately.

**RL56 900 Series**

- RL560WH9927**=5" /6" Retrofit Baffle - Trim LED Module, 90CRI, 2700K, Matte White
- RL560WH9930**=5" /6" Retrofit Baffle - Trim LED Module, 90CRI, 3000K, Matte White
- RL560WH9935**=5" /6" Retrofit Baffle - Trim LED Module, 90CRI, 3500K, Matte White
- RL560WH9940**=5" /6" Retrofit Baffle - Trim LED Module, 90CRI, 4000K, Matte White
- RL560WH9950**=5" /6" Retrofit Baffle - Trim LED Module, 90CRI, 5000K, Matte White

**Accessory (Order Separately)**

- RL56TRMSNB**=5/6" Satin Nickel Trim Ring, Baffle
- RL56TRMTBZB**=5/6" Tuscan Bronze Trim Ring, Baffle
- RL56TRMWHB**=5/6" White Paintable Trim Ring, Baffle
- RL56TRMSN**=5/6" Satin Nickel Trim Ring
- RL56TRMTBZ**=5/6" Tuscan Bronze Trim Ring
- RL56TRMWH**=5/6" White Paintable Trim Ring
- OT400P**=Oversize Flat White Metal Trim Ring 6" I.D. x 9-1/4" O.D. (ring slips behind RL56 ring, in stepped configuration)
- OT403P**=Oversize White Plastic Trim Ring 6" I.D. x 8" O.D. (ring slips behind RL56 ring, in stepped configuration)
- TRM690WH**=Oversize Matte White Metal Trim Ring. Designed for RL560 ring to inset into oversize ring for an even (non-stepped) trim surface
- HE26LED**=Replacement screw base adapter (one included with unit)



E26 Screw base adapter for retrofit (included)

**Housing Compatibility**

Compatible Halo LED Housings with LED luminaire connector (high-efficacy compliant)		
HALO LED	Recessed Can Size	Catalog Number
	5"	H550ICAT, H550RICAT, E550ICAT, E550RICAT
	6"	H750ICAT, H750RICAT, H750T, H750RINTD010, H750TCP, H2750ICAT, H2750RICAT, E750ICAT, E750RICAT
Halo LED Retrofit Enclosures		
HALO	6"	ML7BXRFK, ML7E26RFK
Compatible Halo Incandescent E26 Screwbase Housings		
HALO	5"	H5ICAT, H5RICAT, H5ICATNB, H5T, H5RT, H25ICAT, H25ICATNB, E5TAT, E5RTAT, H5TNB, E5TATNB, E5ICAT, E5RICAT, E5ICATNB
	6"	H7ICAT, H7RICAT, H7ICT, H7RICT, H7ICATNB, H7ICTNB, H7T, H7RT, H7TNB, H7TCP, H7UICAT, H7UICATNB, H27ICAT, H27RICAT, H27T, H27RT, E7ICAT, E7RICAT, E27ICAT, E27RICAT, E7ICATNB, E7TAT, E7RTAT, E7TATNB, E27TAT, E27RTAT

**RL56 Series LED Retrofit is UL Classified for retrofit in the follow 5/6" recessed housings:**

The RL Series LED light module - trim combination is UL Certified for use with any 5"/6" diameter recessed housing constructed of steel or aluminum with an internal volume that exceeds 107.9 in<sup>3</sup> in addition to those noted above.

**Product and Photometric Data**

**RL56 - 900 SERIES**

Cat No.	CRI	CCT	Lumens	Power (W)	LPW
RL560WH9927	92	2700	940	12.6	75
RL560WH9930	91	3000	930	12.8	73
RL560WH9935	92	3500	940	12.7	74
RL560WH9940	90	4000	1000	13.2	76
RL560WH9950	90	5000	1015	12.9	79

**RL56-900 Series Photometric\***

RL560WH9930		
Luminaire lumens		930
Input watts		12.8
LER (LPW)		72.7
Spacing Criteria	0-180	1.16
	90-270	1.16
	Diagonal	1.22
Beam angle (degrees)		88.9
Field angle (degrees)		140
Zonal lumen	Lumens	% Lumens
0-30	341	36.7
0-40	535	57.5
0-60	829	89.1
0-90	930	100

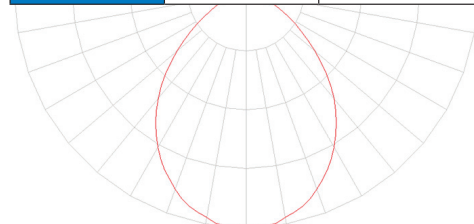

\* Tested in accordance with IES LM63. Field results may vary.

**LIGHTING FACTS**

**RL560WH9927**  
2700K Source

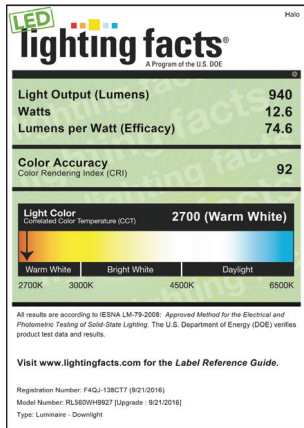

**RL560WH9930**  
3000K Source

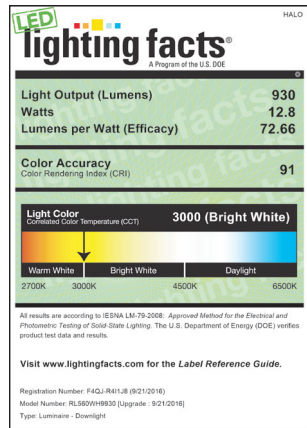

**RL560WH9935**  
3500K Source

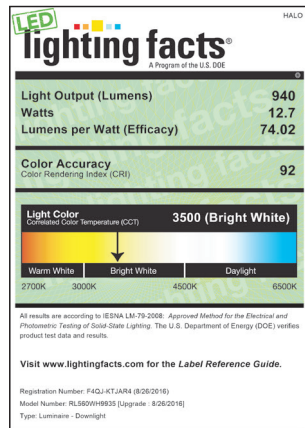

**RL560WH9940**  
4000K Source

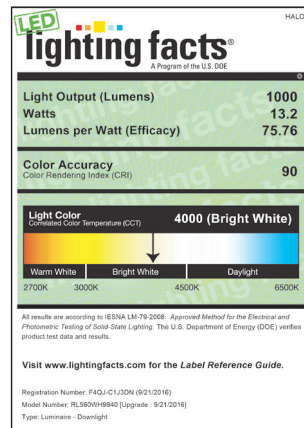

**RL560WH9950**  
5000K Source

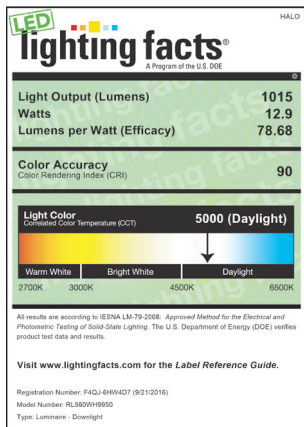

**Description**

The Halo RL560 is a complete LED Baffle-Trim Module for 5" and 6" aperture recessed downlights; suitable for new construction, remodel and retrofit installation. The RL560 is cULus Listed for use with Halo and All-Pro, and is UL Classified for use with other compatible 5" and 6" housings. The RL560 with integral LED driver offers 120 volt dimming capability. The RL560 lens provides uniform illumination and wet location listing. Precision construction makes any housing AIR-TITE for added HVAC savings and code compliance. Compliant with NFPA 70, NEC section 410.16 (A)(1) and 410.16 (C)(3).

Catalog #		Type
Project		
Comments		Date
Prepared by		

**Specification Features**

**MECHANICAL**

**Module - Trim**

- Module construction includes LED, heat sink, reflector, lens, baffle and trim ring
- Regressed baffle
- Heat sink designed to conduct heat away from the LED keeping the junction temperatures below specified maximums, even when installed in insulated ceiling environments. L70 at 50,000 hours.
- Designer trim finish options (sold separately)
  - White (Paintable) Trim Ring
  - Satin Nickel Trim Ring
  - Tuscan Bronze Trim Ring

**Lens**

- Regressed lens
- Impact-resistant polycarbonate
- Convex form for lamp-like appearance
- High lumen transmission
- Diffusing for even illumination

**Mounting**

- Integral torsion springs and Push-N-Twist clips offer two mounting options
  - Torsion springs are pre-installed and adjust to fit 5" or 6" compatible housings
  - Push-N-Twist universal installation clips are pre-installed and designed to fit 5" or 6" compatible housings

**Housing Compatibility**

See Housing Compatibility

**LED**

- Color Temperature (CCT)<sup>†</sup> Options:
  - 90 CRI: 2700K, 3000K, 3500K, 4000K, and 5000K
- Can be used to comply with California Title 24 High Efficacy requirements. Certified to California Appliance Efficiency Database under JAB.

**LED Chromaticity**

- A tight chromaticity specification ensures LED color uniformity, sustainable Color Rendering Index (CRI) and Correlated Color Temperature (CCT) over the useful life of the LED
- LED chromaticity of 3 SDCM exceeds ENERGY STAR<sup>®</sup> color standards per ANSI C78.377-2008

- High color performance with R9 greater than 50
- Every Halo LED is quality tested, measured, and serialized in a permanent record to register lumens, wattage, CRI and CCT
- Halo LED serialized testing and measurement ensures color and lumen consistency on a per-unit basis, and validates long-term product consistency over time

**ELECTRICAL**

**Power Connections**

- LED connector is a non-screw base luminaire disconnect offering easy installation with the matching Halo 5" and 6" LED housings
- LED Connector meets California Title-24 high efficacy luminaire requirement for a non-screw base socket, and where required to qualify as a high efficacy luminaire
- The included E26 medium screw-base Edison adapter provides easy retrofit of incandescent housings (see Housing Compatibility)

**Ground Connection**

Separate grounding cable included on the module for attachment to the housing during installation.

**LED Driver**

- Dimmable driver is a 120 Volt, high efficiency, electronic power supply providing DC power to the LED
- Driver meets FCC EMI/RFI Consumer Level limits for use in residential and commercial installations

- Driver features high power factor, low THD, and has integral thermal protection in the event of over temperature or internal failure

**Dimming**

- Designed for continuous dimming capability to nominally 5% with many 120V Leading Edge (LE) and Trailing Edge (TE) Phase Control dimmers. (Dimmers with low end trim adjustment offer greater assurance of achieving 5% level.)
- Consult dimmer manufacturer for compatibility and conditions of use

**Note:** some dimmers require a neutral in the wallbox.

**Warranty**

Eaton provides a five year limited warranty on RL56 LED.

**Compliance Labels**

- UL Certified 1598 Luminaire with Halo housings and others - see Housing Compatibility
- UL Certified for Damp Location
- IP56 Ingress Protection rated
- May be installed in housings in direct contact with insulation\*\* and combustible material

**Compliance**

- Airtight certified per ASTM E283 (not exceeding 2.0 CFM under 75 Pascals pressure difference)
- 90 CRI: Can be used to comply with California Title 24 High Efficacy requirements. Certified to California Title 20 Appliance Efficiency Database.\*
- 80 CRI: Can be used to comply with California Title 24 Non-Residential Lighting Controls requirements as an LED luminaire
- Can be used for International Energy Conservation Code (IECC) high efficiency luminaire compliance
- Can be used for Washington State Energy Code compliance
- ENERGY STAR<sup>®</sup> Certified luminaire - consult ENERGY STAR<sup>®</sup> Certified Product List\*
- EMI/RFI per FCC 47CFR Part 15 Class B Consumer limits, suitable for use in residential and commercial installations
- Contains no mercury or lead and RoHS compliant
- Photometric testing in accordance with IES LM-79
- Lumen maintenance projections in accordance with IES LM-80 and TM-21
- Suitable for use in closets. Compliant with NFPA 70, NEC Sec. 410.16 (A)(1) and 410.16 (C)(3).



**RL560WH9<sup>†</sup>**

White

**900 Series  
5/6-Inch LED  
Recessed Retrofit  
Module-Trim**

**90CRI  
2700K, 3000K, 3500K,  
4000K, 5000K**

**FOR USE IN  
INSULATED CEILING  
AND NON- INSULATED  
CEILING RATED  
HOUSINGS**

**HIGH EFFICACY LED  
WITH INTEGRAL  
DRIVER - DIMMABLE**



Refer to ENERGY STAR<sup>®</sup> Qualified Products List.  
Can be used to comply with California Title 24 High Efficacy requirements.  
Certified to California Appliance Efficiency Database under JAB.

\* Refer to ENERGY STAR<sup>®</sup> Certified Products List and CEC (T20) Appliance Database for listings.  
\*\* Not for use with housings in direct contact with spray foam insulation.  
† See ordering information table for available models.

**RL56 Dimensions**

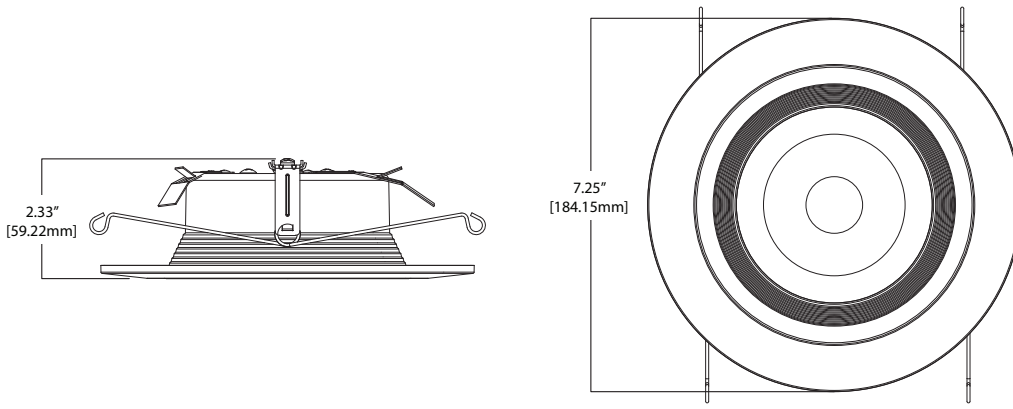

**Designer Trim Dimensions**

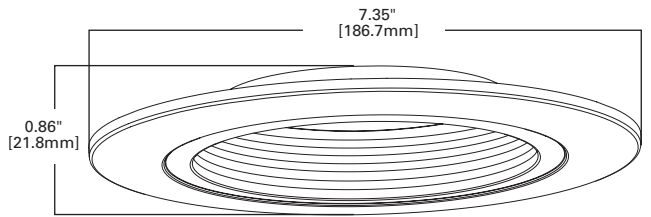

**RL56TRMWHB**  
White (Paintable)

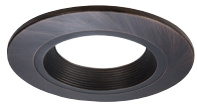

**RL56TRMTBZB**  
Tuscan Bronze



**RL56TRMSNB**  
Satin Nickel

**Energy Data**

**RL56 Series** (Values at non-dimming line voltage)

Minimum Starting Temp: -30°C (-22°F)
EMI/RFI: FCC Title 47 CFR, Part 15, Class B (Consumer)
Sound Rating: Class A
Input Voltage: 120V
Power Factor: >0.90
Input Frequency: 60Hz
THD: <20%
Input Power: 13.5W
Input Current: 0.15A
Maximum IC (Insulated Ceiling) Ambient Continuous Operating Temperature: 25°C (77°F)
Maximum Non-IC Ambient Continuous Operating Temperature 40°C (104°F)

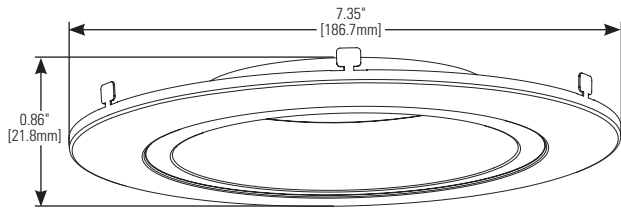

**RL56TRMWH**  
White (Paintable)

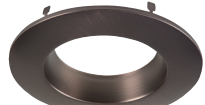

**RL56TRMTBZ**  
Tuscan Bronze



**RL56TRMSN**  
Satin Nickel

**Ordering Information**

Sample Number: **RL560WH9927-RL56TRMSNB**

Complete unit includes a RL56 Baffle-Trim LED Module and a 5" and 6" compatible housing (ordered separately). Optional accessory designer trim ring ordered separately.

**RL56 900 Series**

- RL560WH9927**=5" /6" Retrofit Baffle - Trim LED Module, 90CRI, 2700K, Matte White
- RL560WH9930**=5" /6" Retrofit Baffle - Trim LED Module, 90CRI, 3000K, Matte White
- RL560WH9935**=5" /6" Retrofit Baffle - Trim LED Module, 90CRI, 3500K, Matte White
- RL560WH9940**=5" /6" Retrofit Baffle - Trim LED Module, 90CRI, 4000K, Matte White
- RL560WH9950**=5" /6" Retrofit Baffle - Trim LED Module, 90CRI, 5000K, Matte White

**Accessory (Order Separately)**

- RL56TRMSNB**=5/6" Satin Nickel Trim Ring, Baffle
- RL56TRMTBZB**=5/6" Tuscan Bronze Trim Ring, Baffle
- RL56TRMWHB**=5/6" White Paintable Trim Ring, Baffle
- RL56TRMSN**=5/6" Satin Nickel Trim Ring
- RL56TRMTBZ**=5/6" Tuscan Bronze Trim Ring
- RL56TRMWH**=5/6" White Paintable Trim Ring
- OT400P**=Oversize Flat White Metal Trim Ring 6" I.D. x 9-1/4" O.D. (ring slips behind RL56 ring, in stepped configuration)
- OT403P**=Oversize White Plastic Trim Ring 6" I.D. x 8" O.D. (ring slips behind RL56 ring, in stepped configuration)
- TRM690WH**=Oversize Matte White Metal Trim Ring. Designed for RL560 ring to inset into oversize ring for an even (non-stepped) trim surface
- HE26LED**=Replacement screw base adapter (one included with unit)



E26 Screw base adapter for retrofit (included)

**Housing Compatibility**

Compatible Halo LED Housings with LED luminaire connector (high-efficacy compliant)		
HALO LED	Recessed Can Size	Catalog Number
	5"	H550ICAT, H550RICAT, E550ICAT, E550RICAT
	6"	H750ICAT, H750RICAT, H750T, H750RINTD010, H750TCP, H2750ICAT, H2750RICAT, E750ICAT, E750RICAT
Halo LED Retrofit Enclosures		
HALO	6"	ML7BXRFK, ML7E26RFK
Compatible Halo Incandescent E26 Screwbase Housings		
HALO	5"	H5ICAT, H5RICAT, H5ICATNB, H5T, H5RT, H25ICAT, H25ICATNB, E5TAT, E5RTAT, H5TNB, E5TATNB, E5ICAT, E5RICAT, E5ICATNB
	6"	H7ICAT, H7RICAT, H7ICT, H7RICT, H7ICATNB, H7ICTNB, H7T, H7RT, H7TNB, H7TCP, H7UICAT, H7UICATNB, H27ICAT, H27RICAT, H27T, H27RT, E7ICAT, E7RICAT, E27ICAT, E27RICAT, E7ICATNB, E7TAT, E7RTAT, E7TATNB, E27TAT, E27RTAT

**RL56 Series LED Retrofit is UL Classified for retrofit in the follow 5/6" recessed housings:**

The RL Series LED light module - trim combination is UL Certified for use with any 5"/6" diameter recessed housing constructed of steel or aluminum with an internal volume that exceeds 107.9 in<sup>3</sup> in addition to those noted above.

**Product and Photometric Data**

**RL56 - 900 SERIES**

Cat No.	CRI	CCT	Lumens	Power (W)	LPW
RL560WH9927	92	2700	940	12.6	75
RL560WH9930	91	3000	930	12.8	73
RL560WH9935	92	3500	940	12.7	74
RL560WH9940	90	4000	1000	13.2	76
RL560WH9950	90	5000	1015	12.9	79

**RL56-900 Series Photometric\***

RL560WH9930		
Luminaire lumens		930
Input watts		12.8
LER (LPW)		72.7
Spacing Criteria	0-180	1.16
	90-270	1.16
	Diagonal	1.22
Beam angle (degrees)		88.9
Field angle (degrees)		140
Zonal lumen	Lumens	% Lumens
0-30	341	36.7
0-40	535	57.5
0-60	829	89.1
0-90	930	100

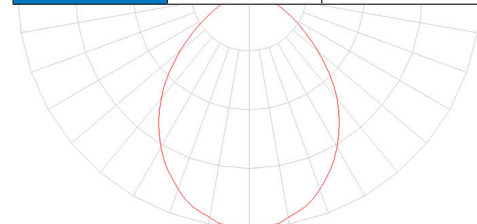

\* Tested in accordance with IES LM63. Field results may vary.

**LIGHTING FACTS**

**RL560WH9927**  
2700K Source

<b>Light Output (Lumens)</b>	<b>940</b>
<b>Watts</b>	<b>12.6</b>
<b>Lumens per Watt (Efficacy)</b>	<b>74.6</b>
<b>Color Accuracy</b> Color Rendering Index (CRI)	<b>92</b>
<b>Light Color</b> Correlated Color Temperature (CCT)	<b>2700 (Warm White)</b>

Warm White    Bright White    Daylight

2700K    3000K    4500K    6500K

Registration Number: F4QJ-138CT7 (9/21/2016)  
Model Number: RL560WH9927 [Upgrade: 9/21/2016]  
Type: Luminaire - Downlight

**RL560WH9930**  
3000K Source

<b>Light Output (Lumens)</b>	<b>930</b>
<b>Watts</b>	<b>12.8</b>
<b>Lumens per Watt (Efficacy)</b>	<b>72.66</b>
<b>Color Accuracy</b> Color Rendering Index (CRI)	<b>91</b>
<b>Light Color</b> Correlated Color Temperature (CCT)	<b>3000 (Bright White)</b>

Warm White    Bright White    Daylight

2700K    3000K    4500K    6500K

Registration Number: F4QJ-R81J8 (9/21/2016)  
Model Number: RL560WH9930 [Upgrade: 9/21/2016]  
Type: Luminaire - Downlight

**RL560WH9935**  
3500K Source

<b>Light Output (Lumens)</b>	<b>940</b>
<b>Watts</b>	<b>12.7</b>
<b>Lumens per Watt (Efficacy)</b>	<b>74.02</b>
<b>Color Accuracy</b> Color Rendering Index (CRI)	<b>92</b>
<b>Light Color</b> Correlated Color Temperature (CCT)	<b>3500 (Bright White)</b>

Warm White    Bright White    Daylight

2700K    3000K    4500K    6500K

Registration Number: F4QJ-KTJARA (8/26/2016)  
Model Number: RL560WH9935 [Upgrade: 8/26/2016]  
Type: Luminaire - Downlight

**RL560WH9940**  
4000K Source

<b>Light Output (Lumens)</b>	<b>1000</b>
<b>Watts</b>	<b>13.2</b>
<b>Lumens per Watt (Efficacy)</b>	<b>75.76</b>
<b>Color Accuracy</b> Color Rendering Index (CRI)	<b>90</b>
<b>Light Color</b> Correlated Color Temperature (CCT)	<b>4000 (Bright White)</b>

Warm White    Bright White    Daylight

2700K    3000K    4500K    6500K

Registration Number: F4QJ-C1J3DN (9/21/2016)  
Model Number: RL560WH9940 [Upgrade: 9/21/2016]  
Type: Luminaire - Downlight

**RL560WH9950**  
5000K Source

<b>Light Output (Lumens)</b>	<b>1015</b>
<b>Watts</b>	<b>12.9</b>
<b>Lumens per Watt (Efficacy)</b>	<b>78.68</b>
<b>Color Accuracy</b> Color Rendering Index (CRI)	<b>90</b>
<b>Light Color</b> Correlated Color Temperature (CCT)	<b>5000 (Daylight)</b>

Warm White    Bright White    Daylight

2700K    3000K    4500K    6500K

Registration Number: F4QJ-6HW4D7 (9/21/2016)  
Model Number: RL560WH9950  
Type: Luminaire - Downlight