

# MAXI-BEAM<sup>®</sup> Sensor Heads



Banner MAXI-BEAM<sup>®</sup> sensors are highly versatile, self-contained, modularized photoelectric sensing controls that are ideally suited to industrial environments. The basic MAXI-BEAM is an ON/OFF switch consisting of three modules (sensor head, power block, and wiring base) and a unique, patented, rotatable "programming ring" that enables you to program your choice of "light" or "dark" operate mode, sensing range, and response time.

MAXI-BEAM sensor heads have an easily-accessible multi-turn SENSITIVITY control for precise adjustment of system gain. Interchangeable sensor heads are rotatable in 90-degree increments and are available in retroreflective, diffuse, opposed, convergent, fixed-field proximity, and fiberoptic sensing modes. Each sensor head also includes Banner's exclusive, patented AID<sup>™</sup> circuit (Alignment Indicating Device\*), which features an LED alignment indicator that lights whenever the sensor "sees" its own modulated light source, and pulses at a rate proportional to the strength of the received light signal.

A wide selection of MAXI-BEAM power block modules is available to interface the sensor head to the circuit to be controlled. The plug-in design of the wiring base enables easy exchange of the entire sensing electronics without disturbing field wiring.

Optional customer-installable logic modules easily convert the basic ON/OFF MAXI-BEAM into either a one-shot or delay logic function control, with several programmable timing ranges for each function.

MAXI-BEAM sensors are ruggedly constructed of molded VALOX<sup>®</sup> to NEMA standards 1, 3, 4, 12, and 13, and have interchangeable molded acrylic lenses. Modules simply snap and bolt together, with no interwiring necessary. Module interfaces are o-ring and quad-ring sealed for the ultimate in dust, dirt, and moisture resistance.

## To order a MAXI-BEAM, follow these steps:

- 1) Select a sensor head module,
- 2) Select a power block module,
- 3) Select a wiring base,
- 4) Select a logic module (if needed),
- 5) Select accessories as needed (see Banner product catalog).

## Sensor Head Modules (described in this data sheet, P/N 03416)

|                            |   |               |
|----------------------------|---|---------------|
| <b>RSBE &amp; RSBR</b>     | opposed mode  | range to 300' |
| <b>RSBESR &amp; RSBRSR</b> | opposed mode (short range; narrow beam)                       | range to 15'  |
| <b>RSBLV</b>               | retroreflective mode  | range to 30'  |
| <b>RSBLVAG</b>             | retroreflective mode (anti-glare filter)                      | range to 15'  |
| <b>RSBD</b>                | long range diffuse proximity mode                             | range to 5'   |
| <b>RSBDSR</b>              | short-range diffuse proximity mode                            | range to 30"  |
| <b>RSBCV</b>               | visible red convergent mode, focus at:                        | 1.5"          |
| <b>RSBC</b>                | infrared convergent mode, focus at:                           | 1.5"          |
| <b>RSBF</b>                | infrared fiber optic; for glass fibers                        |               |
| <b>RSBFV</b>               | visible red fiber optic; for glass fibers                     |               |
| <b>RSBEF &amp; RSBRF</b>   | infrared fiber optic opposed mode; for glass fibers           |               |
| <b>RSBFP</b>               | visible red fiber optic; for plastic fibers                   |               |
| <b>RSBFF50, RSBFF100</b>   | fixed-field proximity; sharp far-limit cutoff at 50 or 100 mm |               |

## Power Block Modules (see data sheet P/N 03418)

|               |  |
|---------------|--|
| <b>RPBT</b>   | 10-30V dc; one sinking and one sourcing solid-state output         |
| <b>RPBT-1</b> | 10-30V dc; for use with RSBE, ESR, EF emitters (no output circuit) |
| <b>RPBTLM</b> | 10-30V dc low-profile power block (requires no RWB4 wiring base)   |
| <b>RPBA</b>   | 105-130V ac (50/60Hz); SPST solid-state output                     |
| <b>RPBA-1</b> | 105-130V ac (50/60Hz); for use with emitter (no output circuit)    |
| <b>R2PBA</b>  | 2-wire operation; 105-130V ac (50/60Hz); SPST solid-state output   |
| <b>RPBB</b>   | 210-250V ac (50/60Hz); SPST solid-state output                     |
| <b>RPBB-1</b> | 210-250V ac (50/60Hz); use with emitter (no output circuit)        |
| <b>R2PBB</b>  | 2-wire operation; 210-250V ac (50/60Hz); SPST solid-state output   |
| <b>RPBU</b>   | 12-250V ac or 12-30V dc; SPST solid-state output (ac or dc)        |
| <b>RPBR</b>   | 12-250V ac (50/60Hz) or 12-30V dc; SPST E/M relay output           |
| <b>RPBR2</b>  | 12-250V ac (50/60Hz) or 12-30V dc; SPDT E/M relay output           |

## Wiring Base (see data sheet P/N 03418)

**RWB4** 4-terminal wiring base for all models (except RPBTLM)

## Logic Modules (see data sheet P/N 03417)

**RLM5** ON/OFF delay (both functions adjustable up to 15 seconds)  
**RLM8** DELAYED ONE-SHOT (delay and pulse adjustable up to 15 seconds)

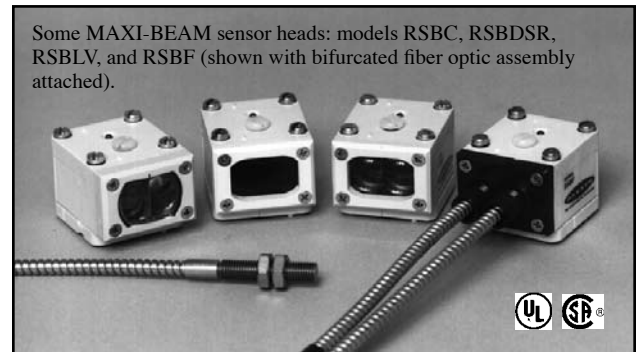

## General Specifications

**Construction:** Reinforced molded VALOX<sup>®</sup> housing, molded acrylic lenses, o-ring and quad-ring gasketed components. Electronic components are fully epoxy encapsulated. NEMA 1, 3, 4, 12, and 13.

**Operating Temperature:** -40 to +70°C (-40 to +158°F).

**Sensitivity Adjustment:** Easily accessible, located on top of the sensor head beneath a watertight gasketed screw-cover. 15-turn clutched control; rotate clockwise to increase sensitivity.

**Alignment Indicator:** Red LED on top of sensor head. Banner's exclusive AID<sup>™</sup> circuit (\*US patent no. 4356393) lights the LED whenever the sensor sees its own modulated light source, and pulses the LED at a rate proportional to the strength of the received light signal.

**False Pulse Suppression on Power-up:** 100ms delay on power-up.

**Response Time and Repeatability:** Specifications to follow in individual product descriptions are independent of signal strength.

VALOX<sup>®</sup> is a registered trademark of General Electric Co.

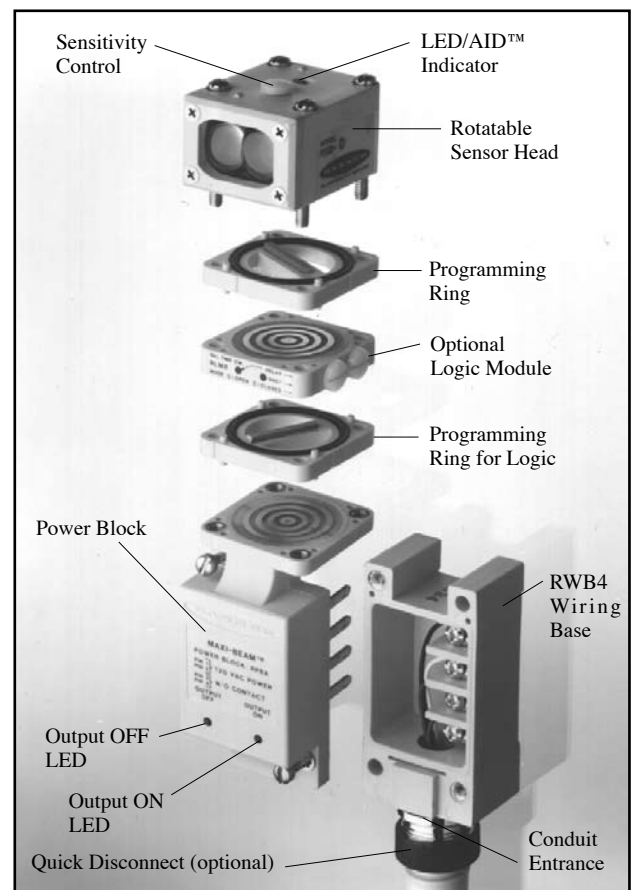

# MAXI-BEAM Sensor Heads

Sensing Mode

Models

Excess Gain

Beam Pattern



## RSBE & RSBR

**Range:** 300 feet (90 m) in "HP" (high power) and 2W (2 wire) modes  
**Beam:** infrared, 880nm; visible red tracer beam  
**Effective Beam:** 0.5" dia.  
**Response:**  
 HP, 2W mode: 10ms on/5 off  
 HS mode: 1ms on/0.5 off  
 SP mode: 0.3ms on/off  
**Repeatability:** HP, 2W= 1.4ms; HS = 0.1ms; SP = 0.04ms

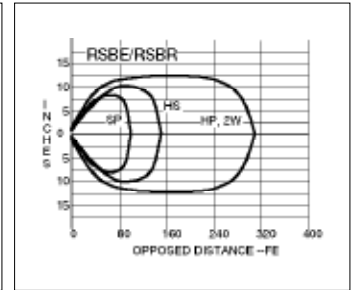
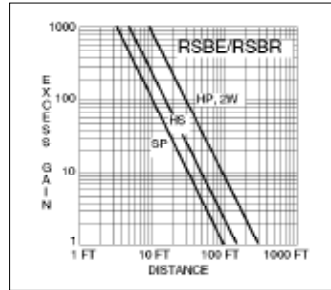

OPPOSED Mode



## RSBESR & RSBRSR

**Range:** 15 feet (4.5m) in "HP" (high power) and 2W (2 wire) modes  
**Beam:** infrared, 880nm  
**Response:**  
 HP, 2W modes: 10ms on/5 off  
 HS mode: 1ms on/0.5 off  
 SP mode: 0.3ms on/off  
**Repeatability:** HP, 2W= 1.4ms; HS = 0.1ms; SP = 0.04ms

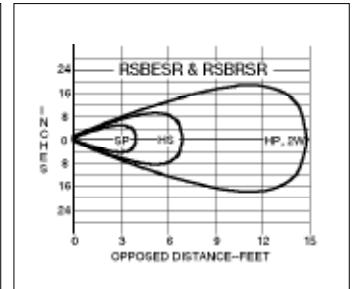
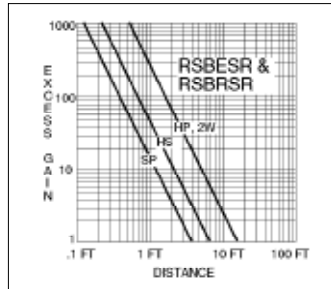

MAXI-BEAM emitters have a visible red "tracer beam". This beam is non-active, and is used as a means of visual alignment during installation. A retroreflector temporarily attached to the receiver lens provides an effective target for the tracer beam during alignment. The narrow beam of the RSBESR/RSBRSR pair is ideal for sensing small parts (effective beam diameter is 0.14 inch).



## RSBEF & RSBRF

**Range:** see excess gain curves  
**Beam:** infrared, 880nm.  
**Response:**  
 HP, 2W modes: 10ms  
 HS mode: 1ms  
 SP mode: 0.3ms on/off  
**Repeatability:** HP, 2W= 3.3ms; HS = 0.3ms; SP = 0.1ms

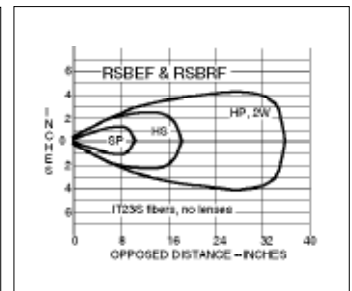
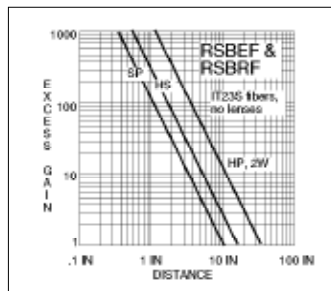

OPPOSED FIBER OPTIC Mode (glass fibers)

This sensor pair is designed for opposed mode operation using Banner glass fiber optics. Maximum range (HP mode) using L9 lenses is 12 feet. Maximum range using L16F lenses is 50 feet.



## RSBLV

**Range:** 6 inches to 30 feet (9 m) in all program modes  
**Beam:** visible red, 650nm  
**Response:**  
 HP, 2W, SP modes: 4ms  
 HS mode: 1ms  
**Repeatability:**  
 HP, 2W, SP = 1.3ms; HS = 0.3ms

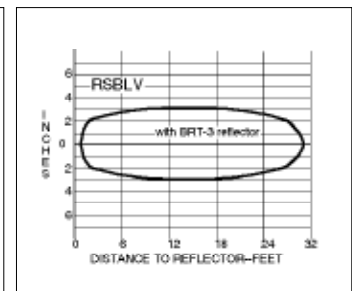
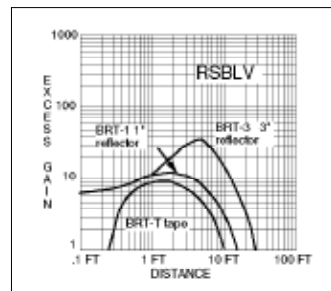

RETROREFLECTIVE Mode



## RSBLVAG (anti-glare filter)

**Range:** 1 to 15 feet (4.5 m) in all program modes  
**Beam:** visible red, 650nm; with polarizing filter  
**Response:**  
 HP, 2W, SP modes: 4ms  
 HS mode: 1ms  
**Repeatability:** HP, 2W, SP = 1.3ms; HS = 0.3ms

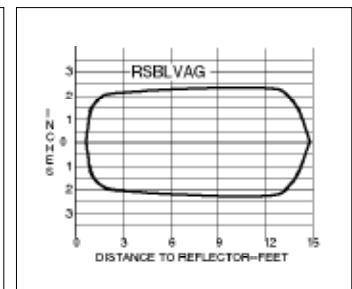
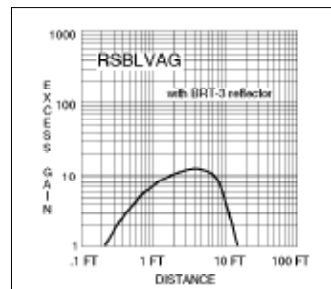

# MAXI-BEAM Sensor Heads

## Sensing Mode

## Models

## Excess Gain

## Beam Pattern



### RSBD

**Range:** 5 feet (1.5 m) in HP and 2W modes

**Beam:** infrared, 880nm

**Response:**

**HP, 2W modes:** 10ms

**HS mode:** 1ms

**SP mode:** 0.3ms

**Repeatability:** **HP, 2W**= 3.3ms; **HS** = 0.3ms; **SP** = 0.1ms

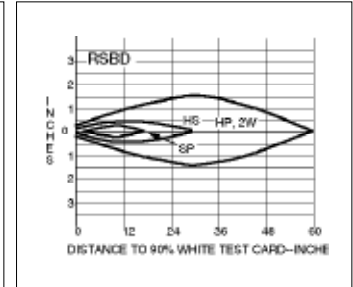
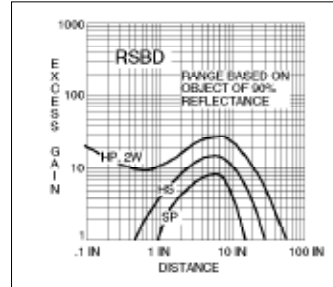

## DIFFUSE Mode



### RSBDSR

(short range)

**Range:** 30 inches (76cm) in HP and 2W modes

**Beam:** infrared, 880nm

**Response:**

**HP, 2W modes:** 10ms

**HS mode:** 1ms

**SP mode:** 0.3ms

**Repeatability:** **HP, 2W**= 3.3ms; **HS** = 0.3ms; **SP** = 0.1ms

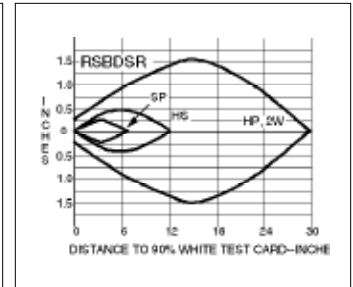
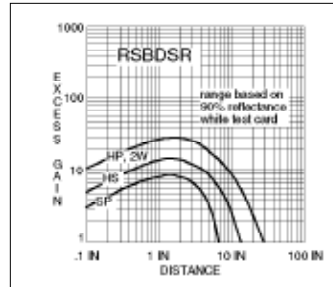

### RSBC

**Focus at 1.5 in.** (38mm)

**Beam:** infrared, 940nm

**Response:**

**HP, 2W modes:** 10ms

**HS mode:** 1ms

**SP mode:** 0.3ms

**Repeatability:** **HP, 2W**= 3.3ms; **HS** = 0.3ms; **SP** = 0.1ms

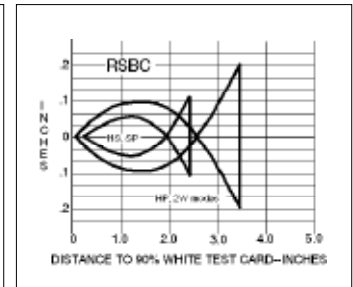
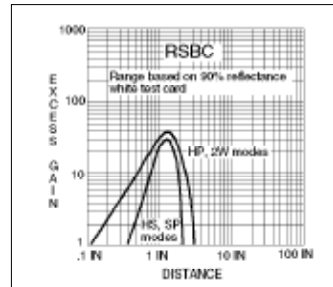

## CONVERGENT Mode



### RSBVCV

**Focus at 1.5 in.** (38mm); performance equal in all program modes.

**Beam:** visible red, 650nm.

**Response:**

**HP, 2W, SP modes:** 4ms

**HS mode:** 1ms

**Repeatability:** **HP, 2W, SP**= 1.3ms; **HS** = 0.3ms

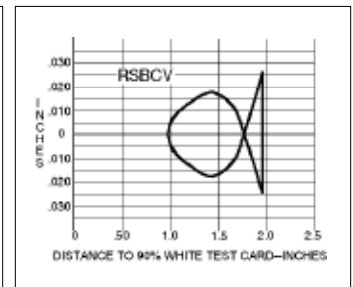
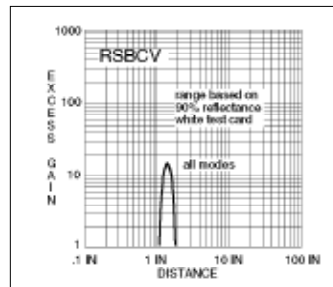

Powerful visible red beam with precise .06" diameter sensing spot. Useful in many high-contrast color registration applications.

## FIXED-FIELD Mode



### RSBFF models

**Far limit cutoff at:** 50mm (model RSBFF50) or 100mm (model RSBFF100)

**Beam:** infrared, 880nm.

**Response:**

**HP mode:** 10ms

**Repeatability:** **HP mode:** 3.3ms

Fixed-field sensor heads have an emitter element and two differently-aimed receiver elements. This creates a high-gain sensing field able to detect objects of low reflectivity, and a sharp far-limit sensing cutoff of 50mm (2 inches) or 100mm (4 inches) which ignores backgrounds beyond cutoff.

These sensors are ideal for detecting a part or surface that is only a fraction of an inch in front of another surface.

RSBFFs may not be used with 2-wire power blocks.

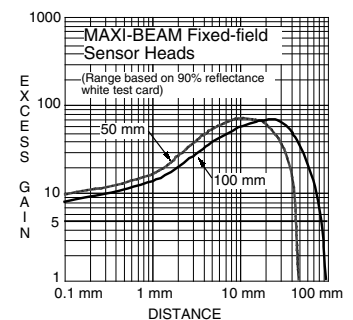

# MAXI-BEAM Sensor Heads

## Sensing Mode

## Models

## Excess Gain

## Beam Pattern

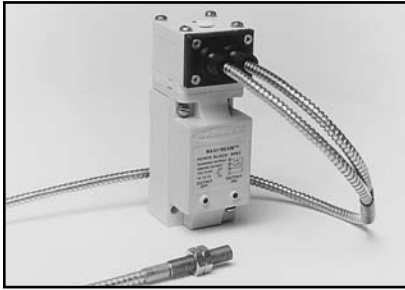

### RSBF

**Range:** see excess gain curves

**Beam:** infrared, 880nm

**Response:**

**HP, 2W modes:** 10ms

**HS mode:** 1ms

**SP mode:** 0.3ms

**Repeatability:**

**HP, 2W =** 3.3ms;

**HS =** 0.3ms;

**SP =** 0.1ms

### FIBER OPTIC Mode

(glass fibers)

OPPOSED MODE

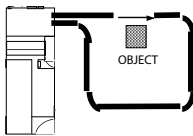

RETRO MODE

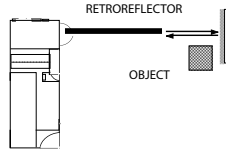

DIFFUSE MODE

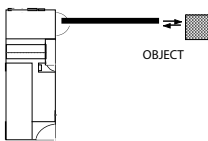

NOTE: if the retroreflective sensing mode is used in conjunction with the HP or 2W program mode, the GAIN control must be reduced from the factory setting in order to avoid optical feedback from the lens assembly.

For information on the complete line of Banner glass fiber optics, see Banner product catalog.

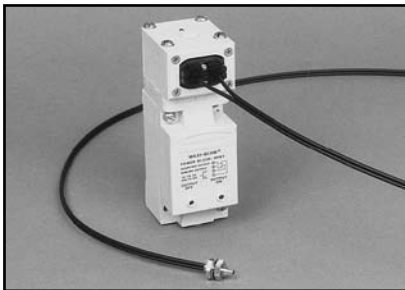
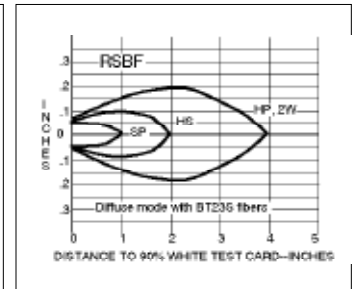
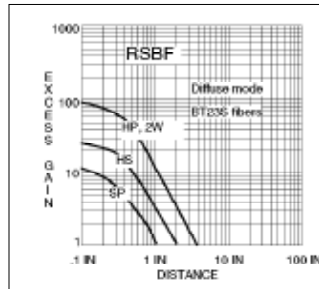
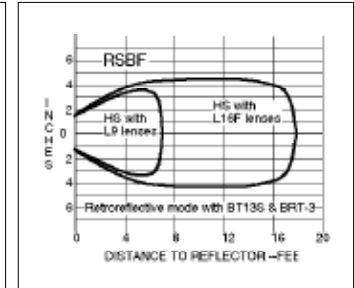
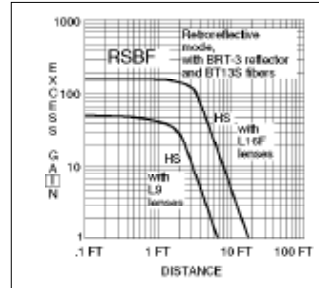
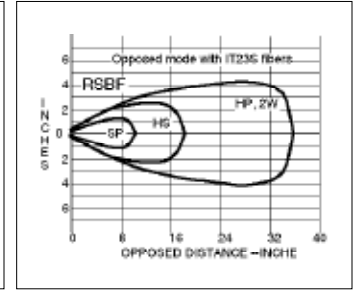
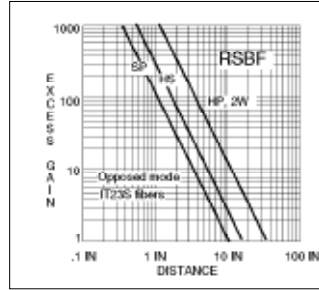

### RSBFP

**Range:** see excess gain curves

**Beam:** visible red, 650nm.

**Response:**

**HS mode only,** 1ms on/off

**Repeatability:**

**HS =** 0.3ms

### FIBER OPTIC Mode

OPPOSED MODE

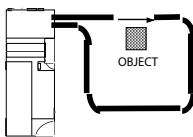

DIFFUSE MODE

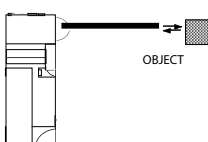

The model RSBFP will function only when programmed for the "HS" response mode.

The model RSBFP will not operate with 2-wire power blocks (models R2PBA and R2PBB).

For information on the complete line of Banner plastic fiber optics, see Banner product catalog.

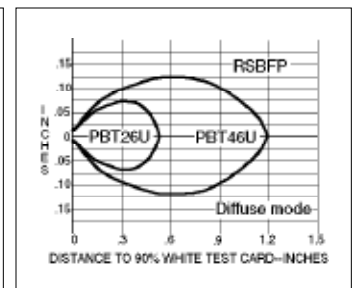
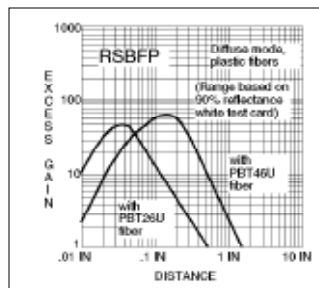
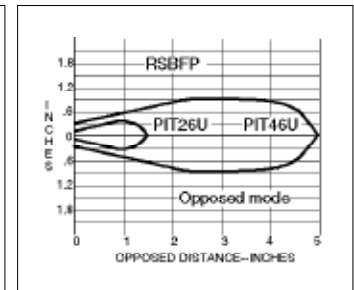
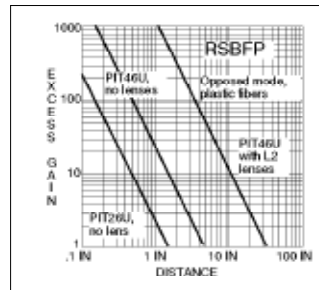

Model RSBFP is a visible-light sensor head designed for use with plastic fiber optics. It is compatible with all standard Banner plastic fiber optic assemblies (see Banner product catalog). In order to function properly, the RSBFP must be programmed for the "HS" response mode. The RSBFP is not for use with glass fiber optics (instead use model RSBF or RSBFV).

# MAXI-BEAM Sensor Heads

Sensing Mode

Models

Excess Gain

Beam Pattern

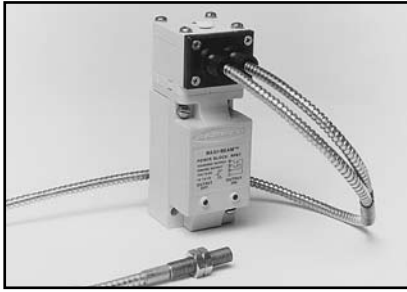

## RSBFV

Range: see excess gain curves  
 Beam: visible red, 650nm.  
 Response:  
 HS mode only, 1ms on/off  
 Repeatability:  
 HS = 0.3ms

The model RSBFV will function only when programmed for the "HS" response mode.

The model RSBFV will not operate with 2-wire power blocks (models R2PBA and R2PBB).

Model RSBFV is a visible-light sensor head designed for use with glass fiber optics. It is compatible with all standard Banner glass fiber optic assemblies (see Banner product catalog). In order to function properly, the RSBFV must be programmed for the "HS" response mode. The RSBFV is not for use with plastic fiber optics (instead use RSBFP).

## FIBER OPTIC Mode (glass fibers)

OPPOSED MODE

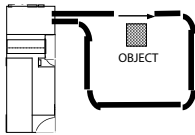

RETRO MODE

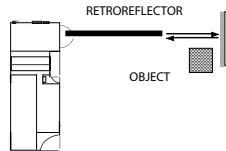

DIFFUSE MODE

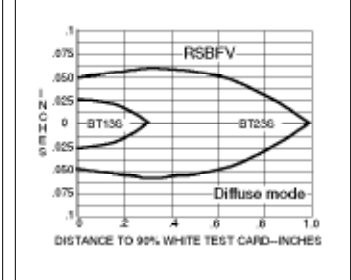
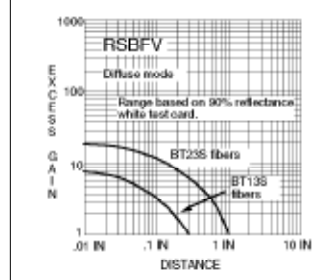
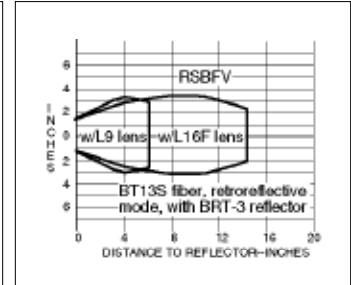
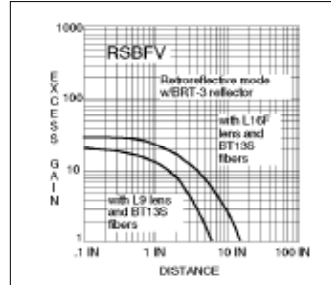
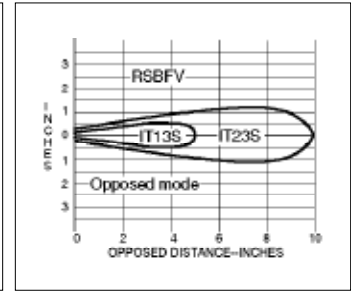
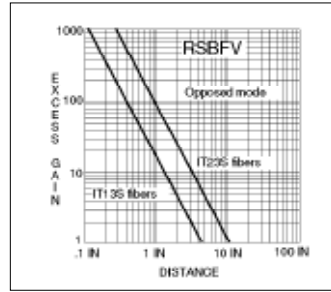
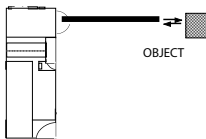

## Programming the MAXI-BEAM Sensor Head

MAXI-BEAM sensor heads may be programmed for sensor response time (and range) and for LIGHT/DARK operate. Each sensor head is supplied with a programming ring which attaches below the the sensor head by a system of pegs. There are four programming notches around the perimeter of the ring. To program the sensor head, simply find the notch which will line up with the desired program combination (see diagram, right). NOTE: the programming ring may have to be turned upside-down in order to line up the notch with the program. If LIGHT OPERATE is selected, the MAXI-BEAM output will energize on a dark-to-light transition. If DARK OPERATE is selected, the MAXI BEAM output will energize on a light-to-dark transition. In the illustration, the MAXI-BEAM is set for high speed (HS) operation in the LIGHT OPERATE output state. See the information about each individual sensor head for the response time and range associated with each setting (HP, 2W, HS, SP). NOTE: when programming the RSBE, RSBSER, or RSBEF emitter, select the mode which is programmed for the receiver. EXCEPTION: if the receiver is programmed for the 2-wire (2W) mode, select high power (HP) on the emitter.

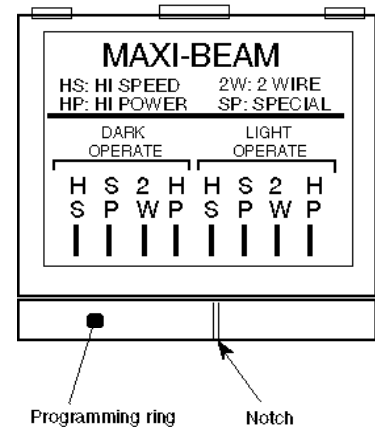

## WARNING

MAXI-BEAM photoelectric presence sensors do NOT include the self-checking redundant circuitry necessary to allow their use in personnel safety applications. A sensor failure or malfunction can result in either an energized or de-energized sensor output condition. Never use these products as sensing devices for personnel protection. Their use as safety devices may create an unsafe condition which could lead to serious injury or death. Only MACHINE- GUARD and PERIMETER- GUARD Systems, and other systems so designated, are designed to meet OSHA and ANSI machine safety standards for point- of -operation guarding devices. No other Banner sensors or controls are designed to meet these standards, and they must NOT be used as sensing devices for personnel protection.

### Dimension Drawing

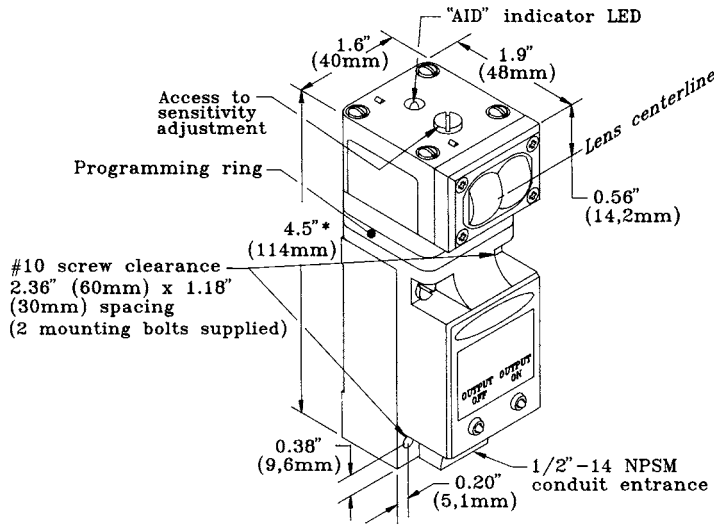

\* 5.0" (127mm) with logic module and second programming ring installed.

### Functional Schematic, MAXI-BEAM Sensor Heads

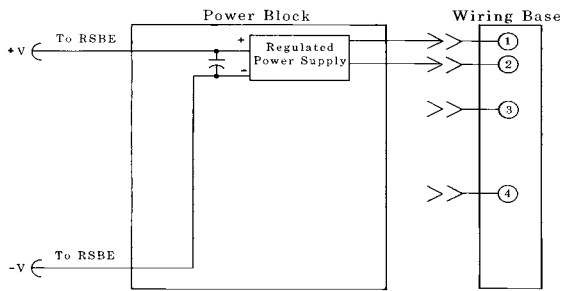

### Composite Functional Schematic, MAXI-BEAM Sensors

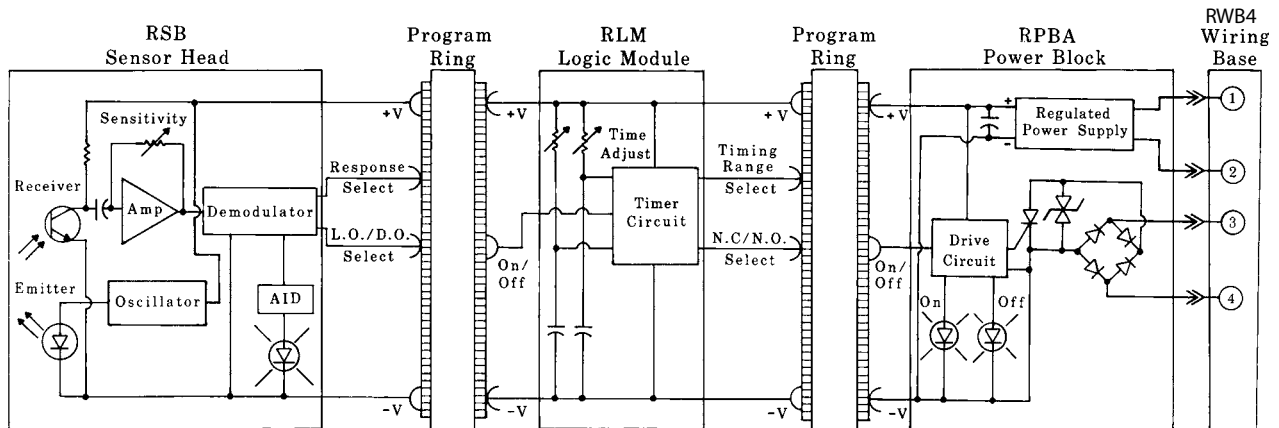

## Banner Engineering Corp Limited Warranty

Banner Engineering Corp. warrants its products to be free from defects in material and workmanship for one year following the date of shipment. Banner Engineering Corp. will repair or replace, free of charge, any product of its manufacture which, at the time it is returned to the factory, is found to have been defective during the warranty period. This warranty does not cover damage or liability for misuse, abuse, or the improper application or installation of the Banner product.

**THIS LIMITED WARRANTY IS EXCLUSIVE AND IN LIEU OF ALL OTHER WARRANTIES WHETHER EXPRESS OR IMPLIED (INCLUDING, WITHOUT LIMITATION, ANY WARRANTY OF MERCHANTABILITY OR FITNESS FOR A PARTICULAR PURPOSE), AND WHETHER ARISING UNDER COURSE OF PERFORMANCE, COURSE OF DEALING OR TRADE USAGE.**

This Warranty is exclusive and limited to repair or, at the discretion of Banner Engineering Corp., replacement. **IN NO EVENT SHALL BANNER ENGINEERING CORP. BE LIABLE TO BUYER OR ANY OTHER PERSON OR ENTITY FOR ANY EXTRA COSTS, EXPENSES, LOSSES, LOSS OF PROFITS, OR ANY INCIDENTAL, CONSEQUENTIAL OR SPECIAL DAMAGES RESULTING FROM ANY PRODUCT DEFECT OR FROM THE USE OR INABILITY TO USE THE PRODUCT, WHETHER ARISING IN CONTRACT OR WARRANTY, STATUTE, TORT, STRICT LIABILITY, NEGLIGENCE, OR OTHERWISE.**

Banner Engineering Corp. reserves the right to change, modify or improve the design of the product without assuming any obligations or liabilities relating to any product previously manufactured by Banner Engineering Corp.

# MAXI-BEAM<sup>®</sup> Sensor Heads



Banner MAXI-BEAM<sup>®</sup> sensors are highly versatile, self-contained, modularized photoelectric sensing controls that are ideally suited to industrial environments. The basic MAXI-BEAM is an ON/OFF switch consisting of three modules (sensor head, power block, and wiring base) and a unique, patented, rotatable "programming ring" that enables you to program your choice of "light" or "dark" operate mode, sensing range, and response time.

MAXI-BEAM sensor heads have an easily-accessible multi-turn SENSITIVITY control for precise adjustment of system gain. Interchangeable sensor heads are rotatable in 90-degree increments and are available in retroreflective, diffuse, opposed, convergent, fixed-field proximity, and fiberoptic sensing modes. Each sensor head also includes Banner's exclusive, patented AID<sup>™</sup> circuit (Alignment Indicating Device\*), which features an LED alignment indicator that lights whenever the sensor "sees" its own modulated light source, and pulses at a rate proportional to the strength of the received light signal.

A wide selection of MAXI-BEAM power block modules is available to interface the sensor head to the circuit to be controlled. The plug-in design of the wiring base enables easy exchange of the entire sensing electronics without disturbing field wiring.

Optional customer-installable logic modules easily convert the basic ON/OFF MAXI-BEAM into either a one-shot or delay logic function control, with several programmable timing ranges for each function.

MAXI-BEAM sensors are ruggedly constructed of molded VALOX<sup>®</sup> to NEMA standards 1, 3, 4, 12, and 13, and have interchangeable molded acrylic lenses. Modules simply snap and bolt together, with no interwiring necessary. Module interfaces are o-ring and quad-ring sealed for the ultimate in dust, dirt, and moisture resistance.

### To order a MAXI-BEAM, follow these steps:

- 1) Select a sensor head module,
- 2) Select a power block module,
- 3) Select a wiring base,
- 4) Select a logic module (if needed),
- 5) Select accessories as needed (see Banner product catalog).

### Sensor Head Modules (described in this data sheet, P/N 03416)

|                            |   |               |
|----------------------------|---|---------------|
| <b>RSBE &amp; RSBR</b>     | opposed mode  | range to 300' |
| <b>RSBESR &amp; RSBRSR</b> | opposed mode (short range; narrow beam)                       | range to 15'  |
| <b>RSBLV</b>               | retroreflective mode  | range to 30'  |
| <b>RSBLVAG</b>             | retroreflective mode (anti-glare filter)                      | range to 15'  |
| <b>RSBD</b>                | long range diffuse proximity mode                             | range to 5'   |
| <b>RSBDSR</b>              | short-range diffuse proximity mode                            | range to 30"  |
| <b>RSBCV</b>               | visible red convergent mode, focus at:                        | 1.5"          |
| <b>RSBC</b>                | infrared convergent mode, focus at:                           | 1.5"          |
| <b>RSBF</b>                | infrared fiber optic; for glass fibers                        |               |
| <b>RSBFV</b>               | visible red fiber optic; for glass fibers                     |               |
| <b>RSBEF &amp; RSBRF</b>   | infrared fiber optic opposed mode; for glass fibers           |               |
| <b>RSBFP</b>               | visible red fiber optic; for plastic fibers                   |               |
| <b>RSBFF50, RSBFF100</b>   | fixed-field proximity; sharp far-limit cutoff at 50 or 100 mm |               |

### Power Block Modules (see data sheet P/N 03418)

|               |  |
|---------------|--|
| <b>RPBT</b>   | 10-30V dc; one sinking and one sourcing solid-state output         |
| <b>RPBT-1</b> | 10-30V dc; for use with RSBE, ESR, EF emitters (no output circuit) |
| <b>RPBTLM</b> | 10-30V dc low-profile power block (requires no RWB4 wiring base)   |
| <b>RPBA</b>   | 105-130V ac (50/60Hz); SPST solid-state output                     |
| <b>RPBA-1</b> | 105-130V ac (50/60Hz); for use with emitter (no output circuit)    |
| <b>R2PBA</b>  | 2-wire operation; 105-130V ac (50/60Hz); SPST solid-state output   |
| <b>RPBB</b>   | 210-250V ac (50/60Hz); SPST solid-state output                     |
| <b>RPBB-1</b> | 210-250V ac (50/60Hz); use with emitter (no output circuit)        |
| <b>R2PBB</b>  | 2-wire operation; 210-250V ac (50/60Hz); SPST solid-state output   |
| <b>RPBU</b>   | 12-250V ac or 12-30V dc; SPST solid-state output (ac or dc)        |
| <b>RPBR</b>   | 12-250V ac (50/60Hz) or 12-30V dc; SPST E/M relay output           |
| <b>RPBR2</b>  | 12-250V ac (50/60Hz) or 12-30V dc; SPDT E/M relay output           |

### Wiring Base (see data sheet P/N 03418)

|             |   |
|-------------|---|
| <b>RWB4</b> | 4-terminal wiring base for all models (except RPBTLM) |
|-------------|---|

### Logic Modules (see data sheet P/N 03417)

|             |  |
|-------------|--|
| <b>RLM5</b> | ON/OFF delay (both functions adjustable up to 15 seconds)      |
| <b>RLM8</b> | DELAYED ONE-SHOT (delay and pulse adjustable up to 15 seconds) |

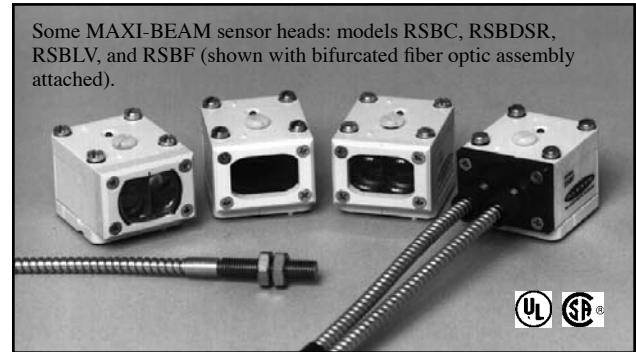

### General Specifications

**Construction:** Reinforced molded VALOX<sup>®</sup> housing, molded acrylic lenses, o-ring and quad-ring gasketed components. Electronic components are fully epoxy encapsulated. NEMA 1, 3, 4, 12, and 13.

**Operating Temperature:** -40 to +70°C (-40 to +158°F).

**Sensitivity Adjustment:** Easily accessible, located on top of the sensor head beneath a watertight gasketed screw-cover. 15-turn clutched control; rotate clockwise to increase sensitivity.

**Alignment Indicator:** Red LED on top of sensor head. Banner's exclusive AID<sup>™</sup> circuit (\*US patent no. 4356393) lights the LED whenever the sensor sees its own modulated light source, and pulses the LED at a rate proportional to the strength of the received light signal.

**False Pulse Suppression on Power-up:** 100ms delay on power-up.

**Response Time and Repeatability:** Specifications to follow in individual product descriptions are independent of signal strength.

VALOX<sup>®</sup> is a registered trademark of General Electric Co.

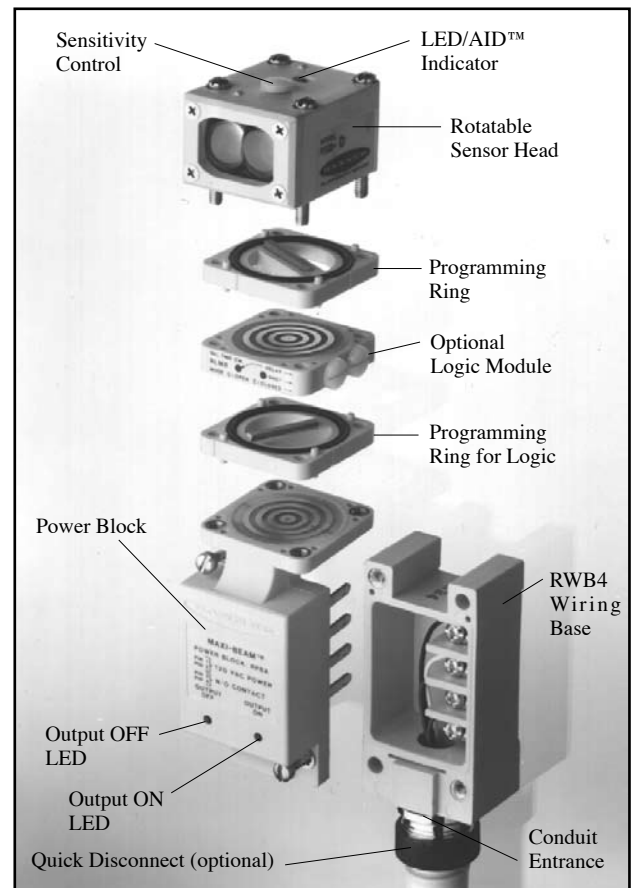

# MAXI-BEAM Sensor Heads

Sensing Mode

Models

Excess Gain

Beam Pattern



**RSBE & RSBR**  
**Range:** 300 feet (90 m) in "HP" (high power) and 2W (2 wire) modes  
**Beam:** infrared, 880nm; visible red tracer beam  
**Effective Beam:** 0.5" dia.  
**Response:**  
 HP, 2W mode: 10ms on/5 off  
 HS mode: 1ms on/0.5 off  
 SP mode: 0.3ms on/off  
**Repeatability:** HP, 2W= 1.4ms; HS = 0.1ms; SP = 0.04ms

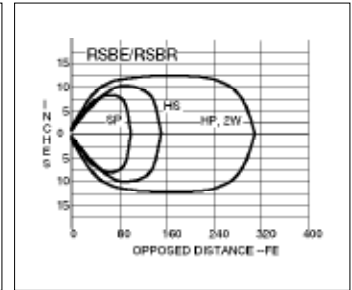
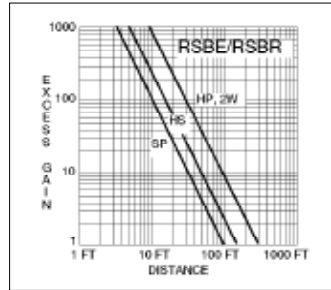

OPPOSED Mode



**RSBESR & RSBRSR**  
**Range:** 15 feet (4.5m) in "HP" (high power) and 2W (2 wire) modes  
**Beam:** infrared, 880nm  
**Response:**  
 HP, 2W modes: 10ms on/5 off  
 HS mode: 1ms on/0.5 off  
 SP mode: 0.3ms on/off  
**Repeatability:** HP, 2W= 1.4ms; HS = 0.1ms; SP = 0.04ms

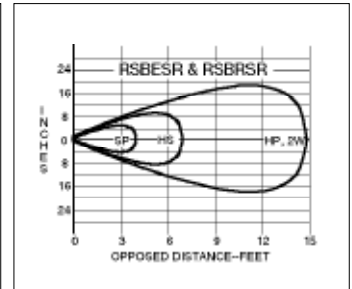
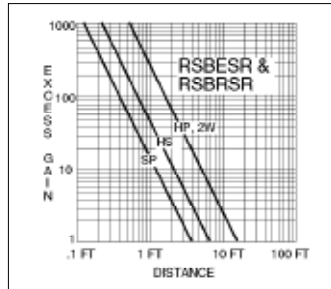

MAXI-BEAM emitters have a visible red "tracer beam". This beam is non-active, and is used as a means of visual alignment during installation. A retroreflector temporarily attached to the receiver lens provides an effective target for the tracer beam during alignment. The narrow beam of the RSBESR/RSBRSR pair is ideal for sensing small parts (effective beam diameter is 0.14 inch).



**RSBEF & RSBRF**  
**Range:** see excess gain curves  
**Beam:** infrared, 880nm.  
**Response:**  
 HP, 2W modes: 10ms  
 HS mode: 1ms  
 SP mode: 0.3ms on/off  
**Repeatability:** HP, 2W= 3.3ms; HS = 0.3ms; SP = 0.1ms

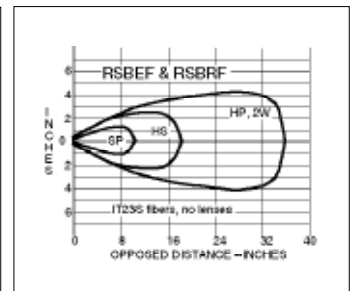
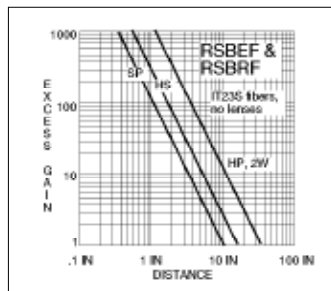

OPPOSED FIBER OPTIC Mode (glass fibers)

This sensor pair is designed for opposed mode operation using Banner glass fiber optics. Maximum range (HP mode) using L9 lenses is 12 feet. Maximum range using L16F lenses is 50 feet.



**RSBLV**  
**Range:** 6 inches to 30 feet (9 m) in all program modes  
**Beam:** visible red, 650nm  
**Response:**  
 HP, 2W, SP modes: 4ms  
 HS mode: 1ms  
**Repeatability:**  
 HP, 2W, SP = 1.3ms; HS = 0.3ms

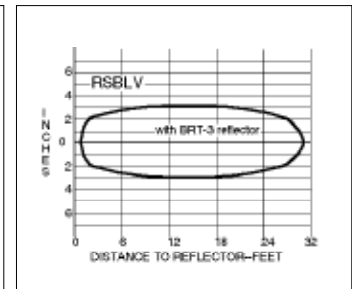
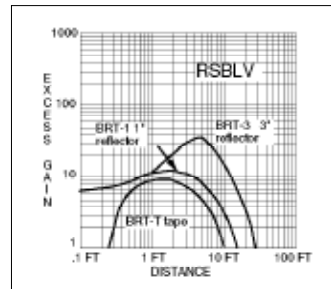

RETROREFLECTIVE Mode



**RSBLVAG**  
 (anti-glare filter)  
**Range:** 1 to 15 feet (4.5 m) in all program modes  
**Beam:** visible red, 650nm; with polarizing filter  
**Response:**  
 HP, 2W, SP modes: 4ms  
 HS mode: 1ms  
**Repeatability:** HP, 2W, SP = 1.3ms; HS = 0.3ms

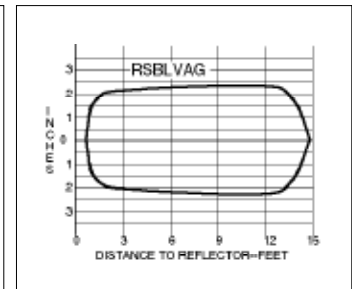
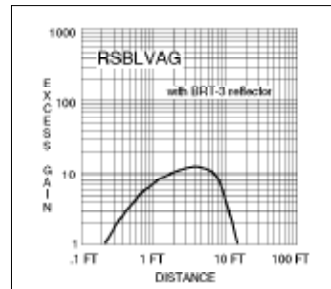



# MAXI-BEAM Sensor Heads

## Sensing Mode

## Models

## Excess Gain

## Beam Pattern



### RSBD

**Range:** 5 feet (1.5 m) in HP and 2W modes

**Beam:** infrared, 880nm

**Response:**

**HP, 2W modes:** 10ms

**HS mode:** 1ms

**SP mode:** 0.3ms

**Repeatability: HP, 2W=** 3.3ms; **HS =** 0.3ms; **SP =** 0.1ms

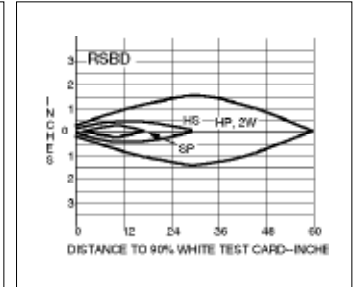
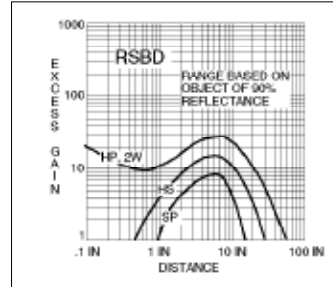

## DIFFUSE Mode



### RSBDSR

(short range)

**Range:** 30 inches (76cm) in HP and 2W modes

**Beam:** infrared, 880nm

**Response:**

**HP, 2W modes:** 10ms

**HS mode:** 1ms

**SP mode:** 0.3ms

**Repeatability: HP, 2W=** 3.3ms; **HS =** 0.3ms; **SP =** 0.1ms

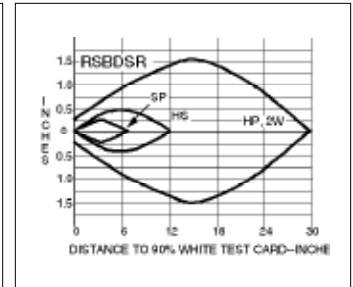
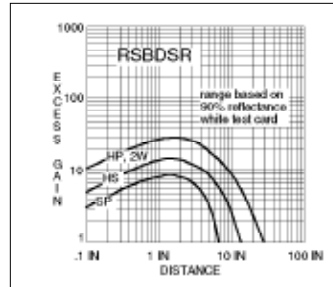

### RSBC

**Focus at** 1.5 in. (38mm)

**Beam:** infrared, 940nm

**Response:**

**HP, 2W modes:** 10ms

**HS mode:** 1ms

**SP mode:** 0.3ms

**Repeatability: HP, 2W=** 3.3ms; **HS =** 0.3ms; **SP =** 0.1ms

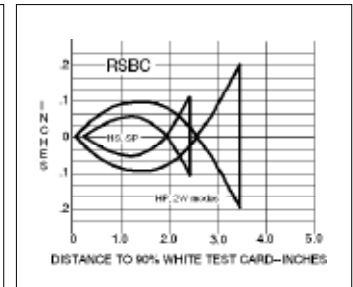
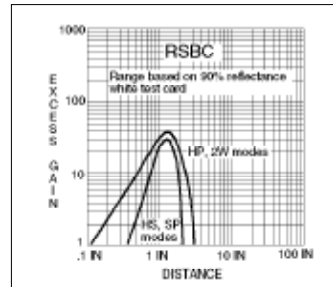

## CONVERGENT Mode



### RSBVCV

**Focus at** 1.5 in. (38mm); performance equal in all program modes.

**Beam:** visible red, 650nm.

**Response:**

**HP, 2W, SP modes:** 4ms

**HS mode:** 1ms

**Repeatability: HP, 2W, SP=** 1.3ms; **HS =** 0.3ms

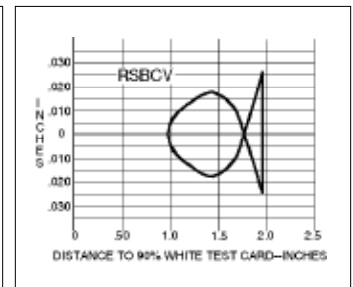
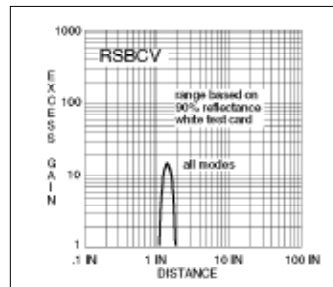

Powerful visible red beam with precise .06" diameter sensing spot. Useful in many high-contrast color registration applications.

## FIXED-FIELD Mode



### RSBFF models

**Far limit cutoff at:** 50mm (model RSBFF50) or 100mm (model RSBFF100)

**Beam:** infrared, 880nm.

**Response:**

**HP mode:** 10ms

**Repeatability: HP mode:** 3.3ms

Fixed-field sensor heads have an emitter element and two differently-aimed receiver elements. This creates a high-gain sensing field able to detect objects of low reflectivity, and a sharp far-limit sensing cutoff of 50mm (2 inches) or 100mm (4 inches) which ignores backgrounds beyond cutoff.

These sensors are ideal for detecting a part or surface that is only a fraction of an inch in front of another surface.

RSBFFs may not be used with 2-wire power blocks.

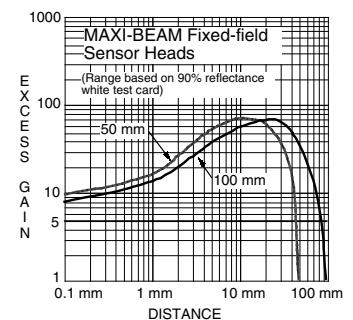

# MAXI-BEAM Sensor Heads

Sensing Mode

Models

Excess Gain

Beam Pattern



## RSBF

**Range:** see excess gain curves

**Beam:** infrared, 880nm

**Response:**

HP, 2W modes: 10ms

HS mode: 1ms

SP mode: 0.3ms

**Repeatability:**

HP, 2W = 3.3ms;

HS = 0.3ms;

SP = 0.1ms

## FIBER OPTIC Mode

(glass fibers)

OPPOSED MODE

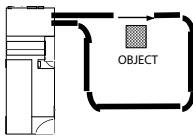

RETRO MODE

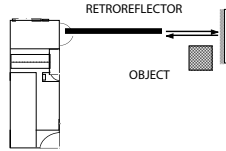

DIFFUSE MODE

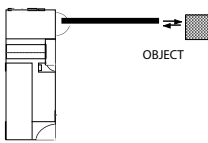

NOTE: if the retroreflective sensing mode is used in conjunction with the HP or 2W program mode, the GAIN control must be reduced from the factory setting in order to avoid optical feedback from the lens assembly.

For information on the complete line of Banner glass fiber optics, see Banner product catalog.

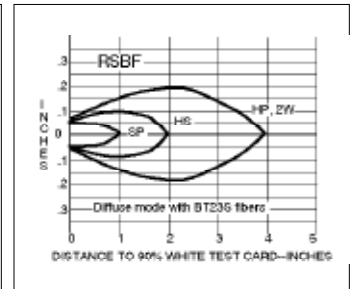
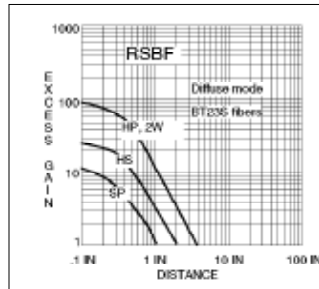
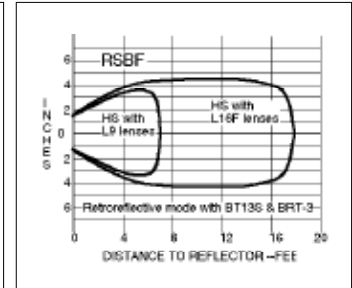
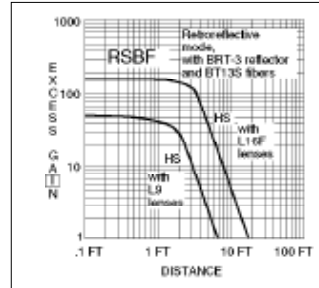
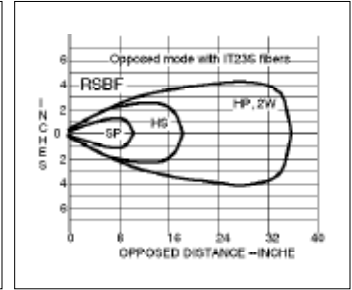
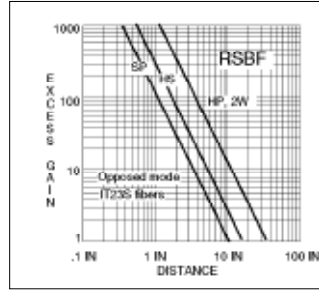

## RSBFP

**Range:** see excess gain curves

**Beam:** visible red, 650nm.

**Response:**

HS mode only, 1ms on/off

**Repeatability:**

HS = 0.3ms

## FIBER OPTIC Mode

OPPOSED MODE

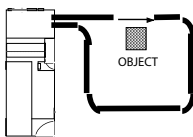

DIFFUSE MODE

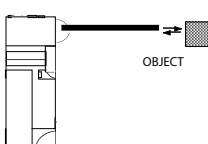

The model RSBFP will function only when programmed for the "HS" response mode.

The model RSBFP will not operate with 2-wire power blocks (models R2PBA and R2PBB).

For information on the complete line of Banner plastic fiber optics, see Banner product catalog.

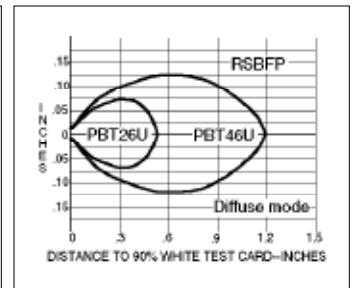
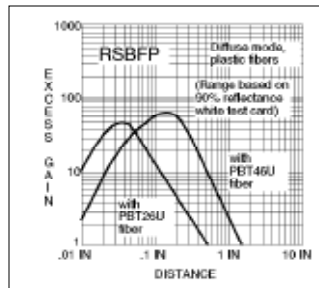
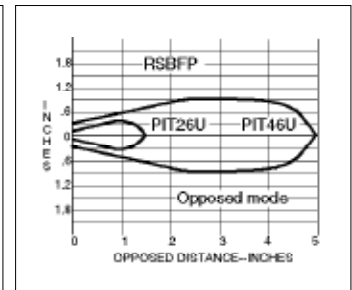
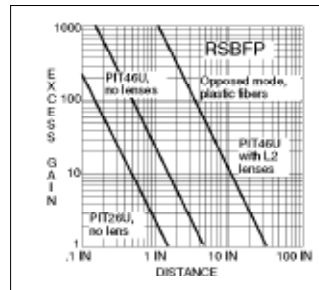

Model RSBFP is a visible-light sensor head designed for use with plastic fiber optics. It is compatible with all standard Banner plastic fiber optic assemblies (see Banner product catalog). In order to function properly, the RSBFP must be programmed for the "HS" response mode. The RSBFP is not for use with glass fiber optics (instead use model RSBF or RSBFV).

# MAXI-BEAM Sensor Heads

Sensing Mode

Models

Excess Gain

Beam Pattern

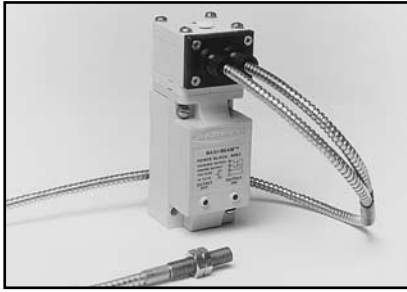

## RSBFV

Range: see excess gain curves  
 Beam: visible red, 650nm.  
 Response:  
 HS mode only, 1ms on/off  
 Repeatability:  
 HS = 0.3ms

The model RSBFV will function only when programmed for the "HS" response mode.

The model RSBFV will not operate with 2-wire power blocks (models R2PBA and R2PBB).

Model RSBFV is a visible-light sensor head designed for use with glass fiber optics. It is compatible with all standard Banner glass fiber optic assemblies (see Banner product catalog). In order to function properly, the RSBFV must be programmed for the "HS" response mode. The RSBFV is not for use with plastic fiber optics (instead use RSBFP).

## FIBER OPTIC Mode (glass fibers)

OPPOSED MODE

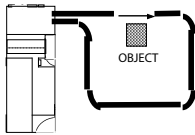

RETRO MODE

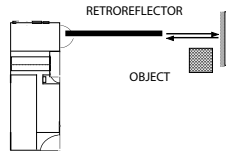

DIFFUSE MODE

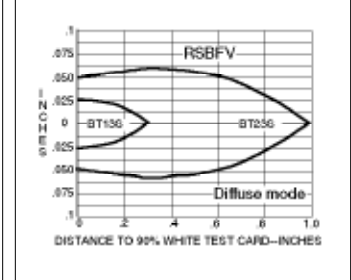
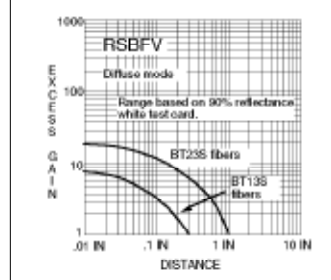
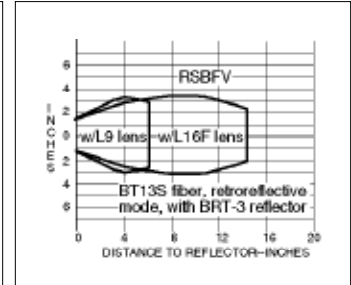
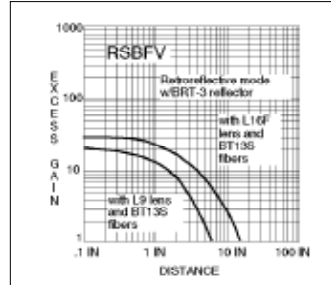
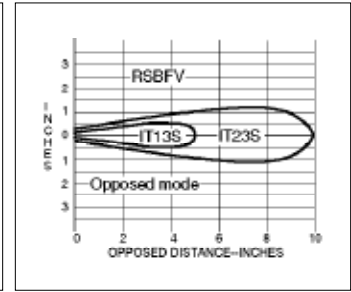
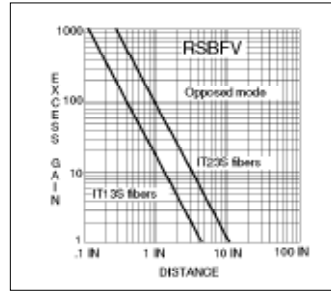
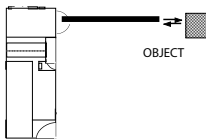

## Programming the MAXI-BEAM Sensor Head

MAXI-BEAM sensor heads may be programmed for sensor response time (and range) and for LIGHT/DARK operate. Each sensor head is supplied with a programming ring which attaches below the the sensor head by a system of pegs. There are four programming notches around the perimeter of the ring. To program the sensor head, simply find the notch which will line up with the desired program combination (see diagram, right). NOTE: the programming ring may have to be turned upside-down in order to line up the notch with the program. If LIGHT OPERATE is selected, the MAXI-BEAM output will energize on a dark-to-light transition. If DARK OPERATE is selected, the MAXI BEAM output will energize on a light-to-dark transition. In the illustration, the MAXI-BEAM is set for high speed (HS) operation in the LIGHT OPERATE output state. See the information about each individual sensor head for the response time and range associated with each setting (HP, 2W, HS, SP). NOTE: when programming the RSBE, RSBSER, or RSBEF emitter, select the mode which is programmed for the receiver. EXCEPTION: if the receiver is programmed for the 2-wire (2W) mode, select high power (HP) on the emitter.

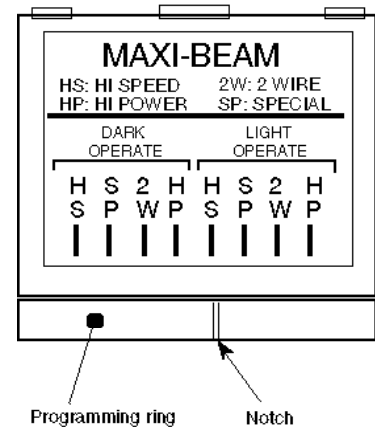

## WARNING

MAXI-BEAM photoelectric presence sensors do NOT include the self-checking redundant circuitry necessary to allow their use in personnel safety applications. A sensor failure or malfunction can result in either an energized or de-energized sensor output condition. Never use these products as sensing devices for personnel protection. Their use as safety devices may create an unsafe condition which could lead to serious injury or death. Only MACHINE- GUARD and PERIMETER- GUARD Systems, and other systems so designated, are designed to meet OSHA and ANSI machine safety standards for point- of -operation guarding devices. No other Banner sensors or controls are designed to meet these standards, and they must NOT be used as sensing devices for personnel protection.

### Dimension Drawing

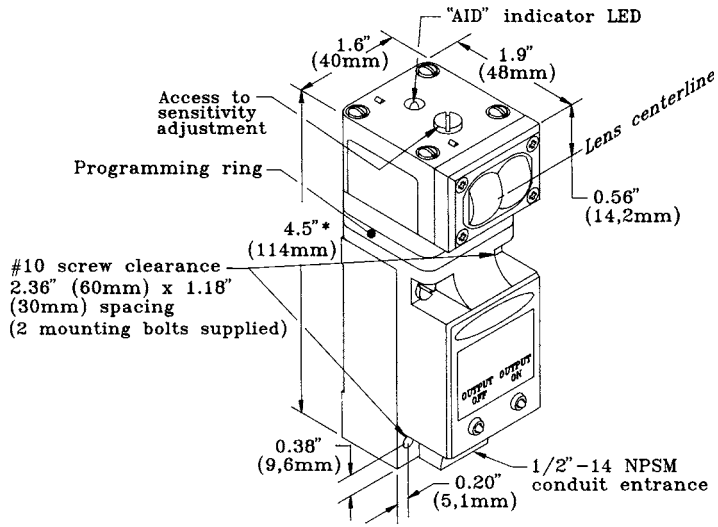

\* 5.0" (127mm) with logic module and second programming ring installed.

### Functional Schematic, MAXI-BEAM Sensor Heads

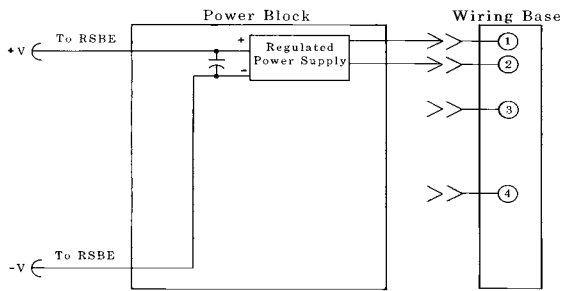

### Composite Functional Schematic, MAXI-BEAM Sensors

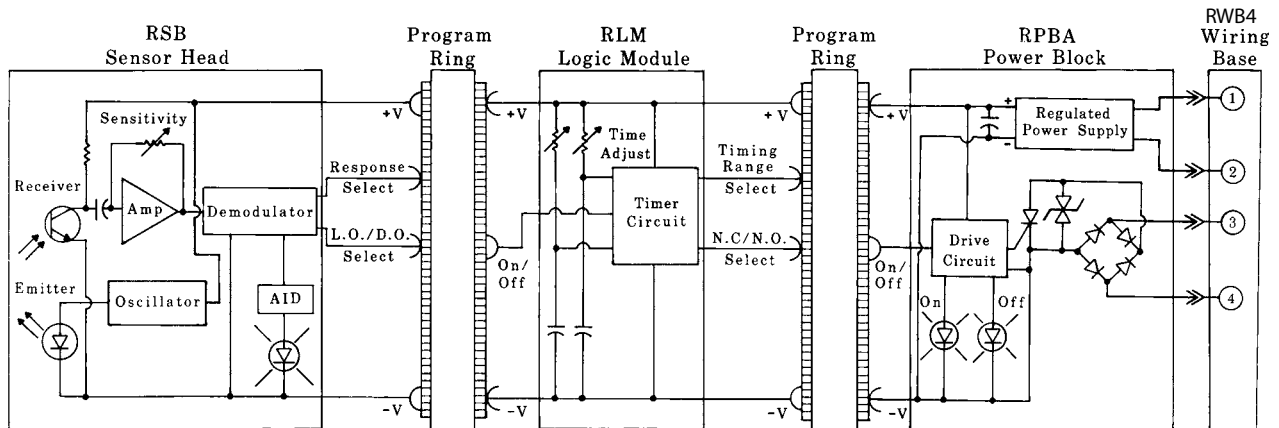

## Banner Engineering Corp Limited Warranty

Banner Engineering Corp. warrants its products to be free from defects in material and workmanship for one year following the date of shipment. Banner Engineering Corp. will repair or replace, free of charge, any product of its manufacture which, at the time it is returned to the factory, is found to have been defective during the warranty period. This warranty does not cover damage or liability for misuse, abuse, or the improper application or installation of the Banner product.

**THIS LIMITED WARRANTY IS EXCLUSIVE AND IN LIEU OF ALL OTHER WARRANTIES WHETHER EXPRESS OR IMPLIED (INCLUDING, WITHOUT LIMITATION, ANY WARRANTY OF MERCHANTABILITY OR FITNESS FOR A PARTICULAR PURPOSE), AND WHETHER ARISING UNDER COURSE OF PERFORMANCE, COURSE OF DEALING OR TRADE USAGE.**

This Warranty is exclusive and limited to repair or, at the discretion of Banner Engineering Corp., replacement. **IN NO EVENT SHALL BANNER ENGINEERING CORP. BE LIABLE TO BUYER OR ANY OTHER PERSON OR ENTITY FOR ANY EXTRA COSTS, EXPENSES, LOSSES, LOSS OF PROFITS, OR ANY INCIDENTAL, CONSEQUENTIAL OR SPECIAL DAMAGES RESULTING FROM ANY PRODUCT DEFECT OR FROM THE USE OR INABILITY TO USE THE PRODUCT, WHETHER ARISING IN CONTRACT OR WARRANTY, STATUTE, TORT, STRICT LIABILITY, NEGLIGENCE, OR OTHERWISE.**

Banner Engineering Corp. reserves the right to change, modify or improve the design of the product without assuming any obligations or liabilities relating to any product previously manufactured by Banner Engineering Corp.