

Your Global Automation Partner

TURCK

ComatReleco World of Relays

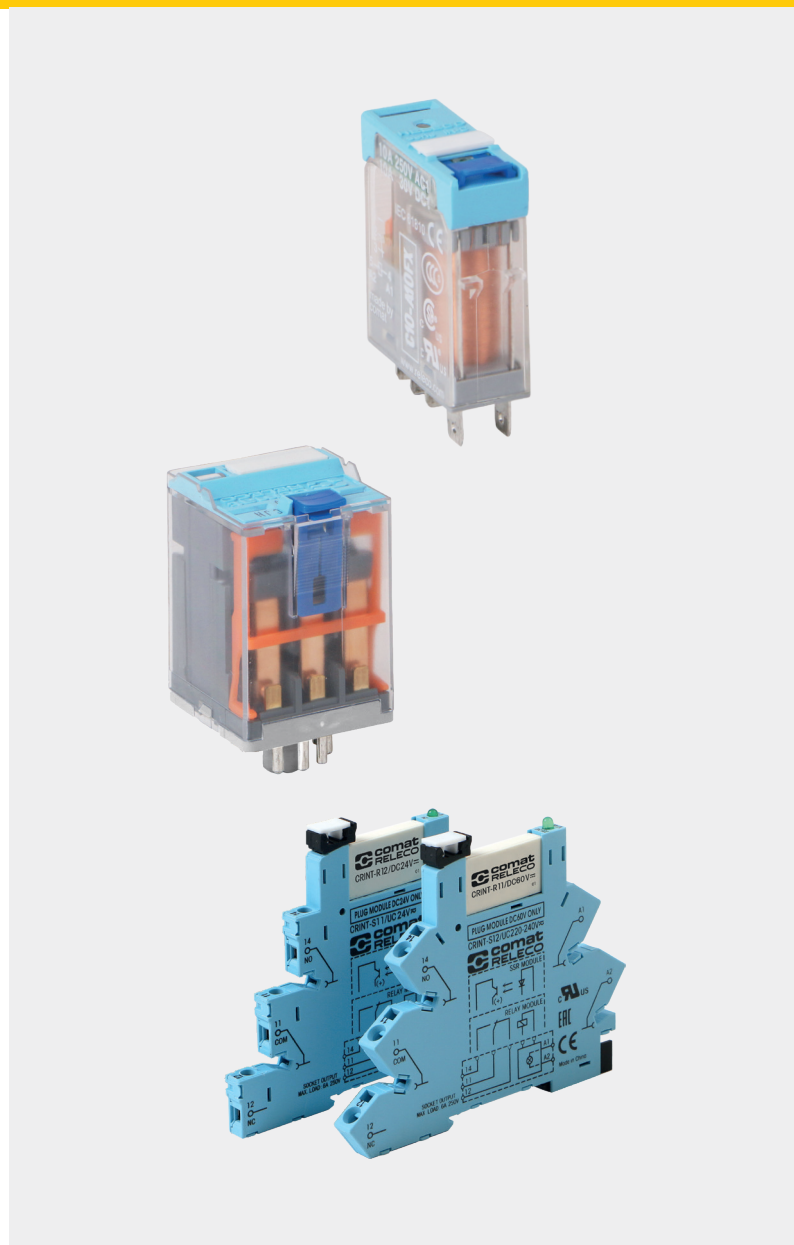

Index

1.0 Relays & Contactors			Page 5
1.1	Interface Relays - pluggable	C10, C12, C16, C18	13
1.2	Interface Relays	CRINT	25
1.3	Industrial Relays - pluggable	C2, C3, C4, C5, C7, C9	31
1.4	Extended Lifetime Relays	C3x	63
1.5	Solid State Relays	CSS, CRINT	67
1.6	Installation Relays	CHI	75
1.8	Solid State Contactors	CC1, CC3, CCR, CPC	79
2.0 Time Relays			Page 95
2.1	On and OFF delay Relays	CMD	99
2.2	Multifunction Time Relays	CIM	105
2.3	Time Cubes	CT	117
2.4	Time Modules	CT	121
3.0 Monitoring & Measuring Devices			Page 125
3.1	Multifunction Monitoring	MRM	127
3.2	Voltage Monitoring	MRU	131
3.3	Current Monitoring	MRI	135
4.0 Sockets			Page 139

1

2

3

4

Index

1.0 Relays & Contactors		2.0 Time Relays		3.0 Monitoring & Measuring Devices		4.0 Sockets		
Type	Page	Type	Page	Type	Page	Type	Page	
C2-A2x...	33	CRINT 1x8...	73	CT2...	117	MRI	136	
C3-A3x...	34	CSS-I...	68	CT3...	117	MRI32	137	
C3-T3x...	35	CSS-N...	70	CT32R, CT33R, CT36R	123	MRM11...	128	
C3-G3x...	36	CSS-P...	71	CIM1..., CIM1R...	106	MRM32...	129	
C3-M1x...	37	CSS-Z...	69	CIM12..., CIM12R...	107	MRU11...	132	
C3-X1x...	38			CIM13..., CIM13R...	108	MRU32...	133	
C3-R2x...	39			CIM14...	109			
C3-N3x...	40			CIM2..., CIM2R...	110		S2-B	143
C4-A4x...	41			CIM22..., CIM22R...	111		S2-PO	144
C4-X2x...	42			CIM23..., CIM23R...	112		S3-B	145
C4-R3x...	43			CIM3..., CIM3R...	113		S3-S	146
C5-A2x...	44			CIM32..., CIM32R...	114		S3-L	147
C5-A3x...	45			CIM33..., CIM33R...	115		S3-PO	147
C5-G3x...	46			CMD11.../UC12 V	100		S3-M	148
C5-X1x...	47			CMD11.../UC24 V	101		S3-MB0	149
C5-M1x...	48			CMD11.../AC115 V	102		S3-MB1	149
C5-M2x...	49			CMD11.../AC230 V	103		S4-J	150
C5-R2x...	50						S4-L	151
C7-A1x...	51						S4-P	151
C7-A2x...	52						S5-M	152
C7-T2x...	53						S5-L	153
C7-G2x...	54						S5-P	153
C7-H2x	55						S5-SSY	154
C7-X1x...	56						S7-C	155
C7-W1x...	57						S7-IO	156
C9-A4x...	58						S7-P	157
C9-E2x...	59						S9-M	158
C9-R2x...	60						S9-P	159
C10-A1x...	14						S10	160
C10-G1x...	15						S10-P	161
C10-T1x...	16						S12	162
C12-A2x...	17						S12-P	163
C12-G2x...	18						S16-M	164
C16-A25PTL...	19						S18-M	165
C18-A15PT...	20							
C18-A15PTL...	21							
C18-B15PTL...	22							
C31...	64							
C32...	65							
CC1H215	80							
CC1H230	81							
CC1H250	82							
CC1H415	83							
CC1H430	84							
CC1H450	85							
CC3H410	86							
CC3H420	87							
CCR3H410	88							
CHI14...	76							
CHI34...	77							
CPC1230	89							
CPC1250	90							
CPC1430	91							
CPC1450	92							
CRINT 1x1...	27							
CRINT 1x2...	28							
CRINT 1x5...	72							

1.0 Relays & Contactors

Industrial Relays

General Information

Product range

ComatReleco offers a wide range of relay types and versions and associated sockets and accessories.

Industrial Relays C2, C3, C4, C5

35 x 35 mm round plug-in relay, 8- or 11-terminals multipole connector according to IEC 67 with 2 or 3 contacts up to 10 A and different contact types and contact materials. Standard relay 35 x 35 mm with flat blade connectors with up to 4 contacts and up to 16 A with 3 contacts.

Industrial Relays C7, C9

22.5 mm series with up to 4 contacts and up to 10 A with 1 or 2 contacts.

Interface Relays, C10, C12, C16, C18

Overall width 13 mm with up to 2 electromechanical contacts, or fully electronic switches.

Special relays, remanence relays

While "normal" relays are monostable, i.e. they return to the idle state when the excitation is switched off, remanence relays are bistable, i.e. the current switching state is retained irrespective of the excitation. Relays of this type are available in different versions.

Solid State Relay CSS

CSS Relays are suitable to either switch AC or DC loads up to 3 A. For AC relays a distinction is made between synchronously (zero crossing) and asynchronously switching versions. For switching transformer loads we recommended using asynchronously switching semiconductor switches. For incandescent lamp loads etc. synchronously switching switches are ideal for avoiding high switch-on currents.

Accessories

Suitable sockets are available for the different relay series for DIN rail mounting or panel mounting. In addition, retaining clips are available for the relays, some of which are included in the scope of supply. Suitable bridges for cost-saving wiring in series are also available.

* Special requirements

H = Orange button. No lockable function
N = Black button. No function
P = PCB pins

E = Lap transparent cover
T = Close transparent cover (lamp)

PT = PCB pins, 3.5mm grid, transparent cover
PTL = PCB pins, 5mm grid, transparent cover

If other requirements, please consult.

Basic identification principle (type designation code electromechanical relays)

C **n(n)** - **T** **X** **y** **z(*)z** **/...V** **RF-nnnn**

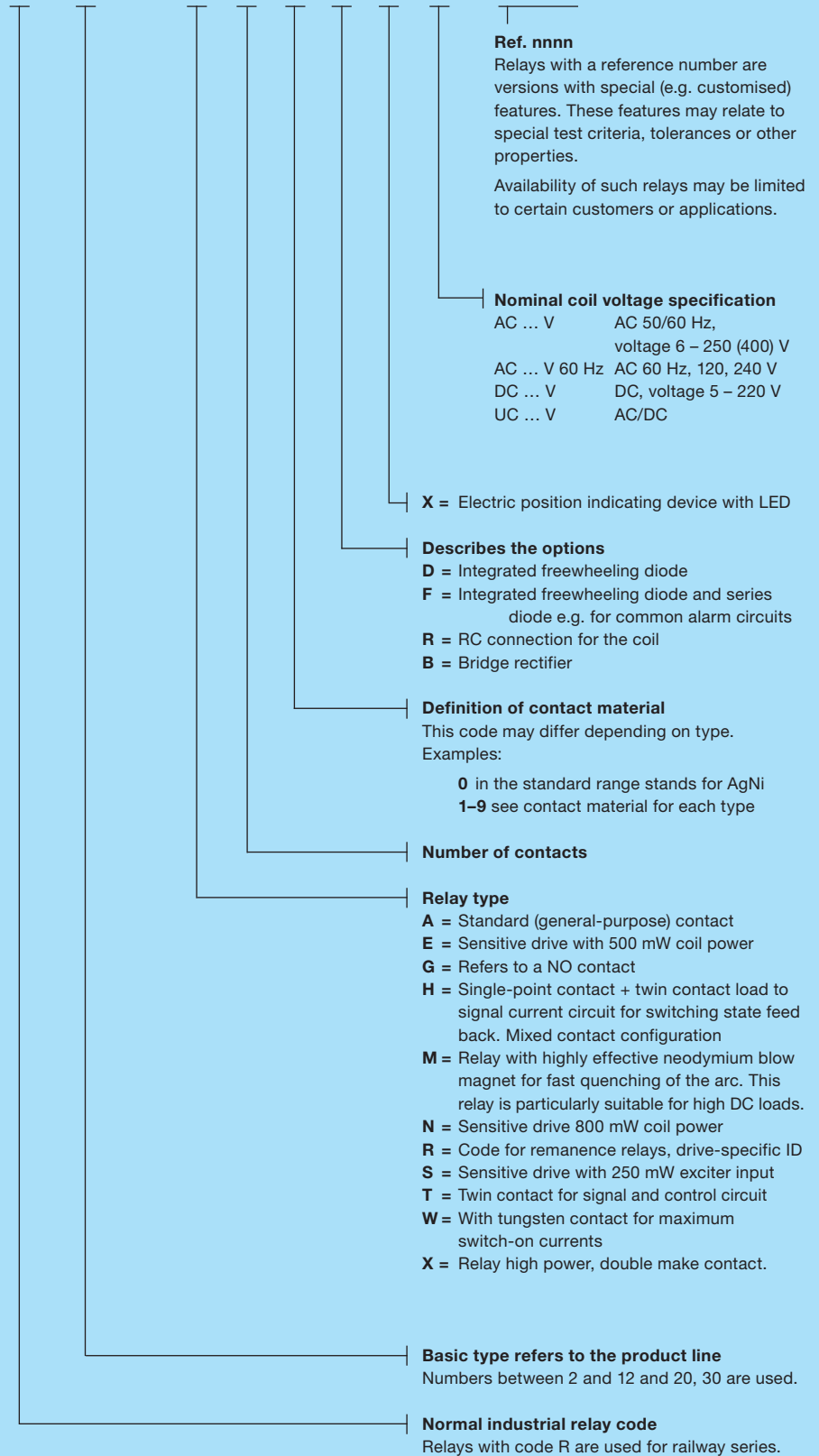

Coil accessories
General Information

Industrial Relays C2-C9

Protection against transients

When the coil is disconnected from an electro-magnet, peaks of inverse voltage appear at the terminals which can reach very high values. These pulses can be transmitted down the line associated with the coil and could possibly affect other components. In the case of a relay being operated by such devices as transistors, Triacs, etc; it may be necessary to protect against transients.

Transients carried in the line

High voltage surges can be carried in the supply line to the relay coil. These may appear in the form of peaks or bursts and are generated by the connection and disconnection of electric motors, transformers, capacitors etc. Normally a relay is unaffected by these pulses, but if a diode is connected in association with the coil, it must be capable of withstanding an inverse voltage higher than those of the incoming peaks.

Protection circuits

A protection circuit must efficiently cope with pulses generated by the coil as well as incoming line surges (surges $U_{1,2/50\mu s}$). ComatReleco Relays are available with integrated protection circuits or with modules plugged into sockets S3-MP or S3-MS.

- X** LED indication with rectifier.
For DC and AC relays up to 250 V
Note: LED connected, in series with the coil @ 220 VDC in QRC types.
- D** Free-wheeling diode.
- DX** Free-wheeling diode + LED
Dampens transients caused by the relay coil on de-energisation.
- F** Polarity + free wheeling diode.
- FX** Polarity + free wheeling diode + LED
A diode in series with the coil protects the relay from reverse connection.
- B** Bridge rectifier incorporated
- BX** Bridge rectifier + LED indication
Allows the relay to operate in both AC or DC without any polarity inconvenience. Available only in voltages up to 60 V.
- R** Resistor and capacitor.

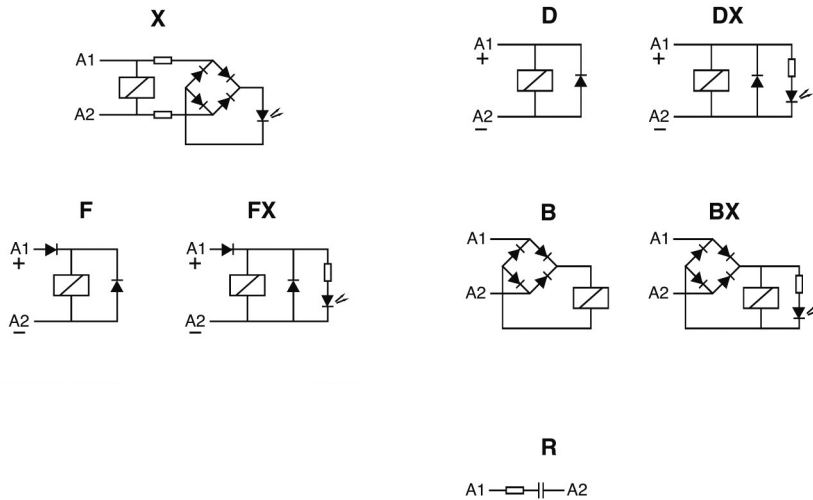

Industrial Relays C10-C18

LED and protection circuit connected to coil.

- X** LED with no polarity, (standard)
Coils ≤ 12 V CC y CA
LED rectifier bridge in parallel
- X** LED with no polarity, (standard)
Coils ≥ 24 V ... CC y CA
LED rectifier bridge in series
- FX** LED with polarity **A1+** (option)
Every DC coil voltage
Polarity and Free-wheeling diodes
- BX** LED with no polarity, (option)
Only 24 V and 48 V ADC coils
Rectifier bridge for AC/DC relays
- R** LED not available (option)
RC protection against pulses on AC

Protection against pulses

When a relay coil is disconnected, reverse voltage peaks may arise and reach very high values. Said peaks can transmit to the coil associated line and other relays or semiconductors can be affected.

If Triac, transistor, etc. controls a relay, appropriate steps must be taken to avoid or decrease peaks down to a non risky level.

Both Polarity and Free-wheeling diodes (**FX**), must protect coils, to avoid malfunctions provided DC relays in battery are installed.

Making or breaking engines, transformers or contactors in an industrial environmental, may generate high voltage pulses, either isolated or burst, through the main line. The voltage level of those pulse may be high enough to affect the isolation of the coil.

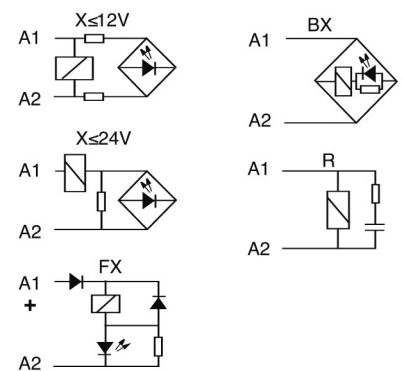

Contacts

There are different contact types. The main distinction is between single contacts and twin contacts. While single contacts are more suitable for higher loads, twin contacts are significantly more reliable at small loads, i.e. < 24 V, < 100 mA.

Contact Material

There is no all-purpose contact!

AgNi is used as standard material for a wide range of applications. AgNi contacts with hard gold plating (up to 5 µm) are offered for applications in aggressive atmosphere.

Relays with gold contacts are approved for relatively high currents (e.g. 6 A, 250 V), but in practice values of 200 mA, 30 V should not be exceeded for operation with intact gold plating.

Relays with a tungsten pre-contact are available for very high switch-on currents (up to 500 A, 2.5 ms). For some applications AgNi contacts with gold flashing (0.2 µm) are available. The purpose is corrosion protection during storage. There is no other purpose. Tin oxide is specially appropriated for load with high-inrush current.

Minimum load

The minimum load value is a recommended value under normal conditions such as regular switching, no special ambient conditions, etc. Under these conditions reliable switching behaviour can be expected.

Contact resistance

Initial values of resistance of contact can vary with the use, load and others conditions. Typical values when the relay is new is about 50 mΩ.

Contact spacing

Normally all contacts have an air gap between 0.5 ... 1.5 mm when they are open. They are referred to as µ contacts. According to the Low-Voltage Directive and the associated standards these contacts are not suitable for safe disconnection.

For switching of DC loads large contact clearances are beneficial for quenching the arc. See special relays: series connections with a gap of 3 mm.

Switching capacity

The contact switching capacity is the product of switching voltage and switching current. For AC the permitted switching capacity is generally high enough to handle the max. continuous AC1 current over the whole voltage range. For DC the load limit curve must never be exceeded, because this would lead to a remaining switch-off arc and immediate destruction of the relay. The order of magnitude of the DC switching capacity is a few 100 W (DC 1).

Drive (coil)

The drive of a relay refers to the coil plus connections.

The coil has special characteristics, depending on the rated voltage and the type of current.

Coil design

The coil consists of a plastic former (resistant up to about 130 °C) and doubly insulated high-purity copper wire, temperature class F. The winding must withstand threshold voltages (EN 61000-4-5) of more than 2000 V. This is ensured through forced separation of the start and end of the winding.

Coil resistance and other properties

Each coil has an ohmic coil resistance that can be verified with an ohmmeter. The specified coil resistance applies to a temperature of 20 °C. The tolerance is ± 10 %.

For AC operation the coil current will not match the ohmic value, because self-inductance plays a dominant role. At 230 V this may reach more than 90 H. When a relay is switched off, self-inductance results in a self-induced voltage that may affect the switching source (destruction of transistors, EMC problems).

Drive voltages

A distinction is made between the standardised voltages according to EN 60947 as guaranteed values, and typical values that can be expected with a high degree of probability.

Pick-up voltage, Release voltage

The pick-up voltage is the voltage at which the relay engages safely. For DC the typical trip voltage is approx. 65 % of U_{nom} , for AC approx. 75 %. The release voltage, on the other hand, is approx. 25 % or 60 % respectively.

For DC these voltages are strongly temperature-dependent, according to the temperature coefficient of Cu. This is not the case for AC, where the inductive resistance is the controlling factor, which is practically constant over a wide temperature range.

With AC, in a certain undervoltage range the relay may hum, and the armature may flutter. This voltage range must be avoided.

Operating voltage range

Unless specified otherwise, the following characteristic curve applies for the operating voltage range. The upper limit of the coil voltage is determined by self-heating and the ambient temperature. Self-heating through contacts under high load must not be underestimated. It may be higher than the power dissipation in the drive.

During intermittent operation significantly higher overvoltages temporary may occur for short periods. If in doubt please consult our specialists.

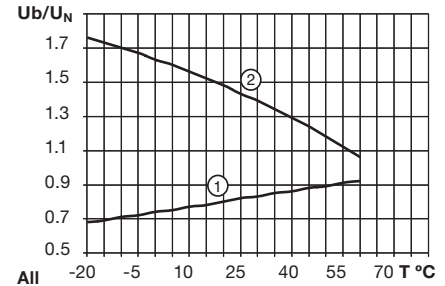

General design

ComatRelco Relays are made from high-quality, carefully selected materials.

They comply with the latest environmental regulations such as RohS. Their meticulous design makes them particularly suitable for industrial applications and installation engineering.

They are particularly service-friendly through robust terminals, mechanical position indicating device a standard, manual operation, dynamic, permanent characteristics.

Colour coding for manual operation as a function of the coil voltage is another useful feature. Further options such as different coil connections, freewheeling diode, LED display, bridge rectifier for AC/DC drives etc., and short-term availability of special versions for practically any drive voltage up to DC 220 V / AC 400 V leave nothing to be desired. Apart from a few special versions, in general, ComatRelco industrial relays feature manual operation (push/pull) and a mechanical position indicating device.

For safety reasons, manual operation may be replaced with a black button, if required.

Coil connections

Different coil connections can be integrated in the relay as an option.

For DC a cost-effective freewheeling diode is available. Please note that the stated release times are generally specified without the coil connection.

While an additional LED status indicator has practically no effect, a freewheeling diode (D) will lead to an increase in release time by a factor 2 to 5, or 10 ms to 30 ms. For AC VDRs or RC elements may be used. In this case resonance effects may have to be considered. VDRs and common RC elements may increase release times by less than 5 ms.

Industrial Relays

General Information

Standards, conformities

While CE marking of relays/sockets is controversial, since relays are sometimes regarded as components to which the marking requirement does not apply, all ComatReleco relays feature the CE mark to indicate that CE standards may also be applied to the relays, e.g. 2 kV surge resistance according to EN 61000-4-5.

A significant and not generally available characteristic is that the coils and in particular the connections are able to withstand the voltage spikes that may occur in practice.

In addition, the relays feature various technical approvals depending on the respective relay code, and they comply with further standards and guidelines. The main technical approvals include cURus, CSA, and CCC.

The associated information is provided in the respective data sheets.

Switching classes

EN 60947 defines different switching classes that specify the suitability of contacts for different load types.

Examples:

AC-1 = Ohmic AC load

AC-3 = Motor loads

AC-15 = Power contactors, solenoid valves, solenoids

DC-1 = Ohmic DC load

DC-13 = DC contactors, solenoids



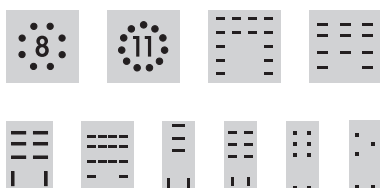

UL60947 contains different technical approval criteria such as general purpose, control application etc. Switching classes are defined based on the electrical switching capacity, e.g. B600 etc.

Choosing the right Socket

For the plug-in industry, interface, time, and monitoring relays, we offer sockets with the corresponding pin configuration and various layouts for the terminal connectors. For easy identification, all plug-in relays and the sockets are labelled with a corresponding symbol.



Main technical approvals and standards

Country	Technical approval
China	 Authority: CQC Specification GB14048.5-2001
Russia	 Authority: KORPORATSIA STANDART Specification TP TC 004/2011
USA	 Authority: UL Specification C 22.2; UL 60947
United Kingdom	 Authority: GB Lloyd's Register of Shipping

Utilisation categories according to
EN 60947-4-1/-5-1

Pollution category

Cat. 1

Dry, non-conductive contamination without further effect

Cat. 2

Occasional conductive contamination, short duration due to moisture condensation

Cat. 3

Dry, non-conductive and conductive contamination with moisture condensation

Cat. 4

Contamination with persistent conductivity through conductive dust, rain

Protection class IP according to EN 60529 and other standards. Industrial relays and their sockets can be classified as follows:
Socket IP20: Contact safety
Relay IP40/IP50: not watertight, but protected against ingress of coarse contaminants.

Railway Applications

Solutions for the transport market need to guarantee safety, security and comfort. The applications are expected to last a long time under challenging conditions. Be it for high-speed trains, metros, subways or other rail vehicles
- in tunnels, on bridges, in train stations, airports, on the open track, or in harbor facilities, the Comat Releco Group has the right solution for different kind of applications. We offer a wide range of relays, control and monitoring devices that are developed in compliance with the European Railway Standard EN 50155 (including also EN 61373, EN 45545 and NF F 16-101/102).

Further information and tips

The main operational criteria for relays such as number of cycles, switching frequency, ambient conditions, reliability requirements, load type, switch-on current, load switch-off energy must be clarified in order to ensure reliable operation and long service life.

Example

If the number of cycles is expected to exceed several 100.000 operations per year (e.g. clock generators, fast running machines), an electronic solution is no doubt more appropriate, although we also offer solutions for this type of application. In AC applications crosstalk caused by long control leads is often problem and can result in constant humming of the relay or even inadvertent triggering due to interference. Here, too, we offer solutions.

Various, apparently harmless loads may lead to very high switch-on currents or switch-off energy values, resulting in an unacceptable reduction in service life.

Particularly tricky are DC loads, particularly if they are inductive.

Circuits with relays and their connections often require a level of developer skill that is frequently no longer offered during standard education and training.

Your supplier will be very happy to provide expert advice

Characteristics of various loads:

Heating circuits

No higher switch-on currents, no higher switch-off loads.

Incandescent lamps, halogen lamps

Switch-on currents during a few ms in the range 10 ... 18 x rated. Switch-off at rated load.

Low-energy lamps

Very high, but very short switch-on currents due to built-in decoupling capacitors.

Contacts have a tendency to fuse.

Transformers, AC contactors

Switching on during zero-transition may lead to switch-on currents of 8 ... 15 x rated. High inductive switch-off energy is possible. The load must be connected, not least due to EMC problems.

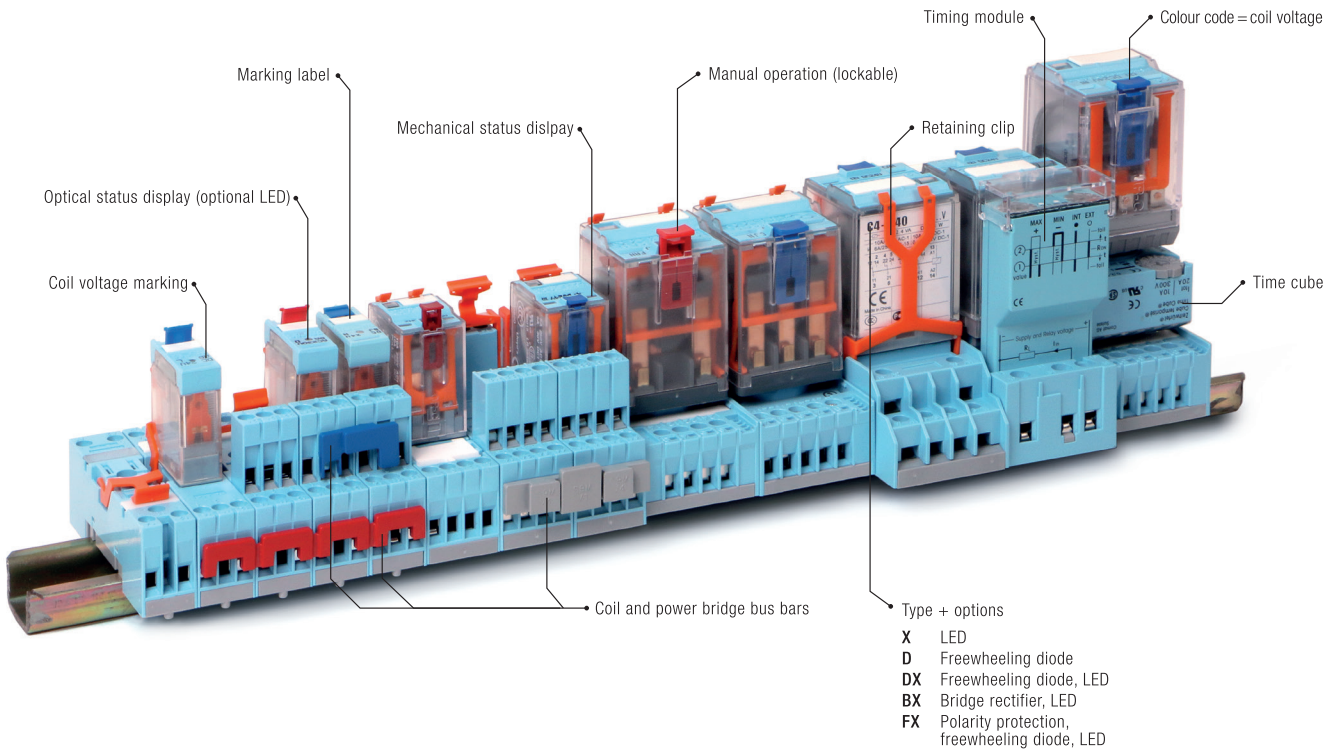

- Type + options
- X LED
 - D Freewheeling diode
 - DX Freewheeling diode, LED
 - BX Bridge rectifier, LED
 - FX Polarity protection, freewheeling diode, LED

Five colours for an easier identification of coil voltage

-  **AC** red: 230 V AC (North America 120 V AC)
-  **AC** dark red: others V AC
-  **UC** grey: V AC/DC
-  **DC** blue: 24 VDC
-  **DC** dark blue: others VDC

If you don't want to have the lockable function, you can use the orange "orange - push button".
 SO - OP for MRC - C and S9 - OP for QRC (BAG 5 PCS)

 Orange - push button

A black blanking plug is available if you don't want a test button.
 S= - NP for MR - C and S9 - NP for QRC (BAG 5 PCS)





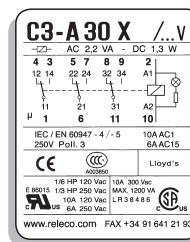









 Blanking plug

Comprehensive technical label





















Part number
 Coil details
 Additional circuit diagram for coil
 Electric diagram showing all additions to the coil
 Wiring diagram with sequential and DIN numbers
 Maximum switching capacity according to EN 60947 (IEC 947)
 Approvals

- Level of switching current and voltage of the application?
- DC or AC switching?
- Inductive or capacitive load?
- Expected number of switching cycles?

Symbol	Voltage	Current	Use	Type	Material
Signal relays 	100 mV...5V	10 µA...1 mA	Low-level signals, Standard signals (0...10V/4...20mA)	Gold-plated double contact	 AgNi + Ag
Control relays 	5V...30V	1 mA...100 mA	PLC inputs, Control circuits	double contact	 AgNi
			Frequent, rapid switching procedures	Gold-plated Single Contact	 AgNi + Ag
				Semiconductor	 Mosfet (DC) Triac (AC)
Power relays 	30V...400V	100 mA...16A	Increased AC or DC loads	Single Contact	 AgNi
			Electromagnets (utilisation cat. AC-15/DC-13)	Single Contact	 AgSnO ₂
			Frequent, rapid switching procedures, high reliability, noiseless switching	Semiconductor	 Mosfet (DC) Triac (AC)
High-power relays 	12V...400V	100 mA...16A	Capacitive loads	Early make contact	 AgNi + W AgSnO ₂ + W
			High DC loads, inductive loads	Series contacts	 AgNi AgSnO ₂
			Frequent, rapid switching procedures, high reliability, noiseless switching	Semiconductor	 Mosfet (DC) Triac (AC)

1.1 Interface Relays - pluggable

Application	Types	Pins	Contacts	AC ratings	DC ratings	Socket
C10 Series						
Interface standard relay	C10-A1x			10 A / 250 V	10 A / 30 V	S10
DC load switching	C10-G1x			10 A / 250 V	10 A / 30 V	S10
Low switching load	C10-T1x			6 A / 250 V	6 A / 30 V	S10
C12 Series						
Interface relay	C12-A2x			5 A / 250 V	5 A / 30 V	S12
Interface DC relay	C12-G2x			5 A / 250 V	5 A / 30 V	S12
C16 Series						
Interface DC relay	C16-A25PTL			7 A / 250 V	7 A / 30 V	S18
C18 Series						
Interface DC relay	C18-A15PT			10 A / 250 V	10 A / 30 V	S16
Interface DC relay	C18-A15PTL			10 A / 250 V	10 A / 30 V	S16
Interface DC relay	C18-B15PTL			16 A / 250 V	16 A / 30 V	S18

C10-A1x

1 pole | changeover contact | plug-in Faston

Maximum contact load	10 A/250 V AC-1	0.5 A/110 V DC-1
	10 A/30 V DC-1	0.2 A/220 V DC-1
	13 A/250 V AC-1	
Recommended minimum contact load	10 mA/10 V Code 0.5	
	5 mA/5 V Code 8	

Contacts

Material	Standard	Code 0	AgNi
	Optional	Code 8	AgNi + 5 μ Au
	Optional	Code 5	AgSnO ₂
Rated Load	10 A		
Switch-on current max. (20 ms)	30 A (120 A for code 5)		
Switching voltage max.	250 V		
AC load (Fig 1)	2.5 kVA		
DC load	see fig. 2		

Coil

Coil resistance	see table; tolerance ± 10 %
Pick-up voltage	≤ 0.8 × U _N
Release voltage	≥ 0.1 × U _N
Nominal power	1.1 VA (AC)/0.7 W (DC)

Coil table

V AC	Ω	mA	VDC	Ω	mA
24	290	45	12	224	53
48	1200	23	24	742	32
115	7.300	9.5	48	3.500	13.7
230	28.800	4.7	110	19.900	5.5

Insulation

	Volt rms / 1 min
Contact open	1000 V
Contact/coil	5 kV
Insulation resistance at 500 V	≥ 1 GΩ
Insulation, IEC 61810-1	4 kV

Specifications

Ambient temperature operation/storage	-40 ... 70 °C / -40 ... 80 °C (no ice)
Pick-up time/bounce time	10 ms/ ≤ 1 ms
Release time/bounce time	5 ms/ ≤ 3 ms
Mechanical life ops	AC: 10 Mill./DC: 20 Mill.
DC voltage endurance at rated load	≥ 100 000 switching cycles
Switching frequency at rated load	≤ 1200/h
Weight	21 g

Product References

V AC 50 Hz/60 Hz: 24, 48, 115 (120), 230 (240)	C10-A10/AC...V	C10-A18/AC...V	C10-A15/AC...V
LED	C10-A10X/AC...V	C10-A18X/AC...V	C10-A15X/AC...V
RC Suppressor	C10-A10R/AC...V	C10-A18R/AC...V	C10-A15R/AC...V
VDC 12, 24, 48, 110	C10-A10/DC...V	C10-A18/DC...V	C10-A15/DC...V
LED	C10-A10X/DC...V	C10-A18X/DC...V	C10-A15X/DC...V
Polarity and free wheeling diode	C10-A10FX/DC...V	C10-A18FX/DC...V	C10-A15FX/DC...V
V AC/DC bridge rectifier 24 V, 48 V	C10-A10BX/UC...V	C10-A18BX/UC...V	C10-A15BX/UC...V

Other voltages on request

"..." List Coil Voltage to complete Product References

Accessories

Socket: **S10, S10-P**



Connection diagram

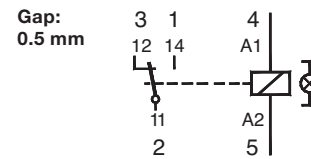

Fig.1 AC voltage endurance

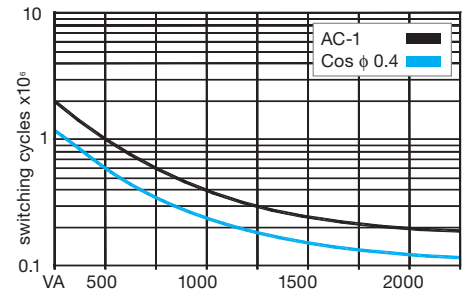
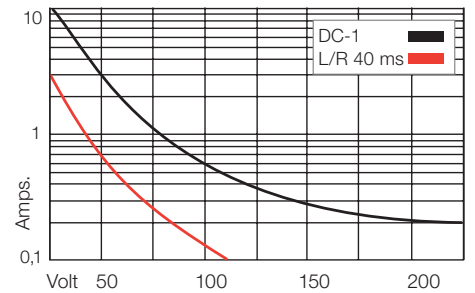
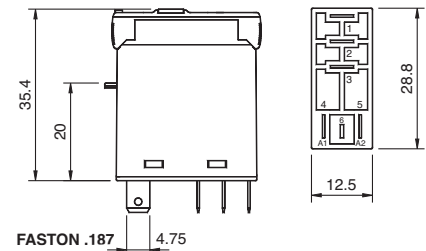

Fig. 2 DC load limit curve



Dimensions



Technical approvals, conformities



IEC/EN 61810; IEC/EN 60947

C10-G1x

1 pole | normally open contact | plug-in Faston

Maximum contact load	10 A/250 V AC-1	0.8 A/110 V DC-1
	10 A/30 V DC-1	0.4 A/220 V DC-1
Recommended minimum contact load	10 mA/10 V Code 0.5	
	5 mA/5 V Code 8	

Contacts

Material	Standard	Code 0	⚡ AgNi
	Optional	Code 8	⚡ AgNi + 5 μ Au
	Optional	Code 5	⚡ AgSnO ₂
Rated Load			10 A
Switch-on current max. (20 ms)			30 A (120 A for code 5)
Switching voltage max.			250 V
AC load (Fig 1)			2.5 kVA
DC load			see Fig. 2

Coil

Coil resistance	see table; tolerance ± 10 %
Pick-up voltage	≤ 0.8 × U _n
Release voltage	≥ 0.1 × U _n
Nominal power	1.1 VA (AC)/0.7 W (DC)

Coil table

V AC	Ω	mA	VDC	Ω	mA
24	290	45	12	224	53
48	1200	23	24	742	32
115	7.300	9.5	48	3.500	13.7
230	28.800	4.7	110	19.900	5.5

Insulation

	Volt rms / 1 min
Contact open	2000 V
Contact/coil	5 kV
Insulation resistance at 500 V	≥ 1 G.Ω
Insulation, IEC 61810-1	4 kV

Specifications

Ambient temperature operation/storage	-40 ... 70 °C / -40 ... 80 °C (no ice)
Pick-up time/bounce time	10 ms/≤ 1 ms
Release time/bounce time	8 ms
Mechanical life ops	AC: 10 Mill./DC: 20 Mill.
DC voltage endurance at rated load	≥ 100 000 switching cycles
Switching frequency at rated load	≤ 1200/h
Weight	21 g

Product References

V AC 50 Hz/60 Hz: 24, 48, 115 (120), 230 (240)

LED

RC Suppressor

VDC 12, 24, 48, 110

LED

Polarity and free wheeling diode

AC/DC bridge rectifier 24 V, 48 V

Other voltages on request

C10-G10/AC ... V
C10-G10X/AC ... V
C10-G10R/AC...V

C10-G15/AC ... V
C10-G15X/AC ... V
C10-G15R/AC...V

C10-G10/DC ... V
C10-G10X/DC ... V
C10-G10FX/DC ... V

C10-G15/DC ... V
C10-G15X/DC ... V
C10-G15FX/DC... V

C10-G10BX/DC ... V

C10-G15BX/UC... V

"..." List Coil Voltage to complete Product References

Accessories

Socket: **S10, S10-P**



Connection diagram

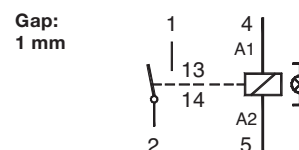

Fig.1 AC voltage endurance

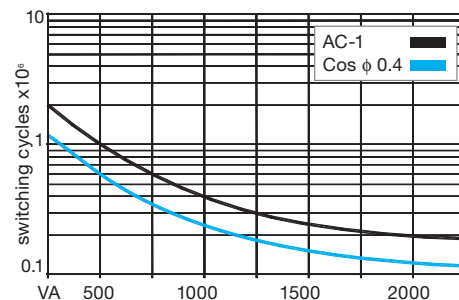
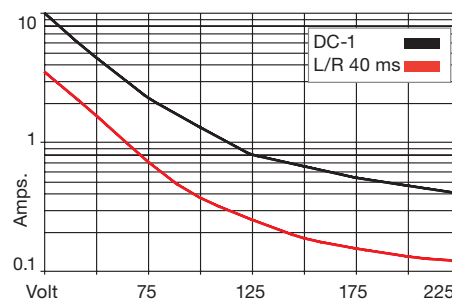
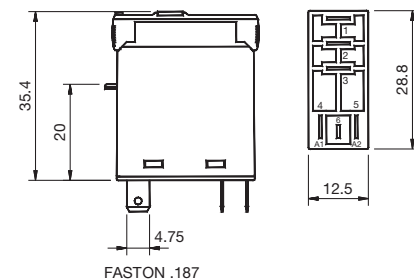

Fig. 2 DC load limit curve



Dimensions



Technical approvals, conformities



C10-T1x

1 pole | changeover twin contact | plug-in Faston

Maximum contact load	6 A/250 V	AC-1	0.5 A/110 V	DC-1
	6 A/30 V	DC-1	0.2 A/220 V	DC-1
Recommended minimum contact load	5 mA/5 V	Code 1		
	1 mA/5 V	Code 3		

Contacts

Material	Standard	Code 1	AgNi + 0.2 μ Au
	Optional	Code 3	AgNi + 5 μ Au
Rated Load			6 A
Switch-on current max. (20 ms)			15 A
Switching voltage max			250 V
AC load (Fig 1)			1.5 kVA
DC load			see fig. 2

Coil

Coil resistance	see table; tolerance ± 10 %
Pick-up voltage	≤ 0.8 × U _N
Release voltage	≥ 0.1 × U _N
Nominal power	1.1 VA (AC)/0.7 W (DC)

Coil table

V AC	Ω	mA	VDC	Ω	mA
24	290	45	12	224	53
48	1200	23	24	742	32
115	7.300	9.5	48	3.500	13.7
230	28.800	4.7	110	19.900	5.5

Insulation

	Volt rms / 1 min
Contact open	1000 V
Contact/coil	5 kV
Insulation resistance at 500 V	≥ 1 GΩ
Insulation, IEC 61810-1	4 kV

Specifications

Ambient temperature operation/storage	-40 ... 70 °C / -40 ... 80 °C (no ice)
Pick-up time/bounce time	10 ms/≤ 1 ms
Release time/bounce time	5 ms/≤ 3 ms
Mechanical life ops	AC: 10 Mill./DC: 20 Mill.
DC voltage endurance at rated load	≥ 100 000 switching cycles
Switching frequency at rated load	1200/h
Weight	21 g

Product References

V AC 50 Hz/60 Hz: 24, 48, 115 (120), 230 (240)

LED

RC Suppressor

VDC12, 24, 48, 110

LED

Polarity and free wheeling diode

AC/DC bridge rectifier 24 V, 48 V

Other voltages on request

C10-T11/AC ... V
C10-T11X/AC ... V
C10-T11R/AC...V

C10-T11/DC ... V
C10-T11X/DC ... V
C10-T11FX/DC ... V

C10-T11BX/UC ... V

C10-T13/AC ... V
C10-T13X/AC ... V
C10-T13R/AC...V

C10-T13/DC ... V
C10-T13X/DC ... V
C10-T13FX/DC ... V

C10-T13BX/UC ... V

"..." List Coil Voltage to complete Product References

Accessories

Socket: **S10, S10-P**



Connection diagram

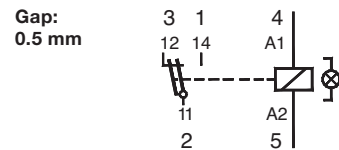

Fig.1 AC voltage endurance

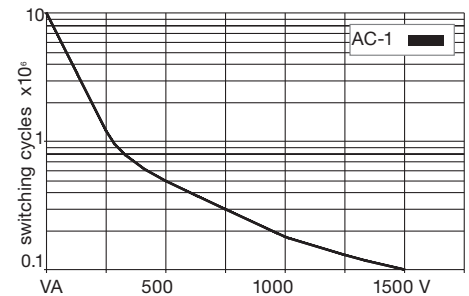
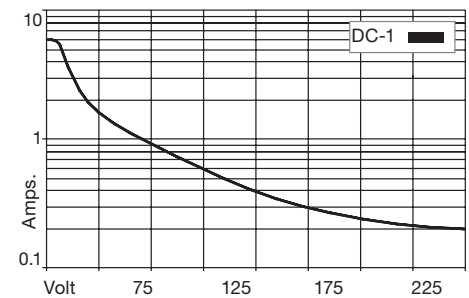
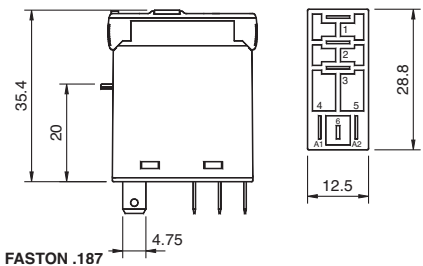

Fig. 2 DC load limit curve



Dimensions



Technical approvals, conformities



C12-A2x

2 pole | changeover contact | plug-in Faston



Maximum contact load	5 A/250 V	AC-1	0.5 A/110 V	DC-1
	5 A/30 V	DC-1	0.2 A/220 V	DC-1
Recommended minimum contact load	10 mA/10 V	Code 1		
	5 mA/5 V	Code 2		

Contacts				
Material	Standard	Code 1	AgNi + 0.2 μ Au	
	Optional	Code 2	AgNi + 5 μ Au	
Rated Load			5 A	
Switch-on current max. (20 ms)			15 A	
Switching voltage max.			250 V	
AC load (Fig 1)			1.2 kVA	
DC load			see fig. 2	

Coil	
Coil resistance	see table; tolerance ± 10 %
Pick-up voltage	≤ 0.8 x U _n
Release voltage	≥ 0.1 x U _n
Nominal power	1.1 VA (AC)/0.7 W (DC)

Coil table	V AC	Ω	mA	VDC	Ω	mA
	24	290	45	12	224	53
	48	1200	23	24	742	32
	115	7.300	9.5	48	3.500	13.7
	230	28.800	4.7	110	19.900	5.5

Insulation	Volt rms / 1 min
Contact open	1000 V
Contact/contact	3000 V
Contact/coil	5 kV
Insulation resistance at 500 V	≥ 1 G.Ω
Insulation, IEC 61810-1	4 kV

Specifications	
Ambient temperature operation/storage	-40 ... 60 °C / -40 ... 80 °C (no ice)
Pick-up time/bounce time	10 ms/≤ 1 ms
Release time/bounce time	5 ms/≤ 3 ms
Mechanical life ops	AC: 10 Mill./DC: 20 Mill.
DC voltage endurance at rated load	≥ 100 000 switching cycles
Switching frequency at rated load	≤ 1200/h
Weight	21 g

Product References		
V AC 50 Hz/60 Hz: 24, 48, 115 (120), 230 (240)	C12-A21/AC ... V	C12-A22/AC ... V
LED	C12-A21X/AC ... V	C12-A22X/AC ... V
RC Suppressor	C12-A21R/AC ... V	C12-A22R/AC ... V
VDC 12, 24, 48, 110	C12-A21/DC ... V	C12-A22/DC ... V
LED	C12-A21X/DC ... V	C12-A22X/DC ... V
Polarity and free wheeling diode	C12-A21FX/DC ... V	C12-A22FX/DC ... V
AC/DC bridge rectifier 24 V, 48 V	C12-A21BX/UC ... V	C12-A22BX/UC ... V
Other voltages on request		

"..." List Coil Voltage to complete Product References

Accessories	
Socket:	S12, S12-P

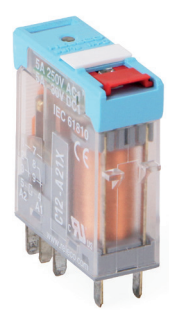

Connection diagram

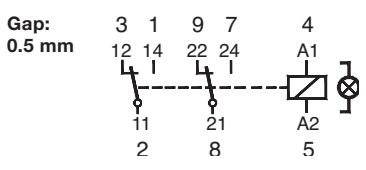

Fig.1 AC voltage endurance

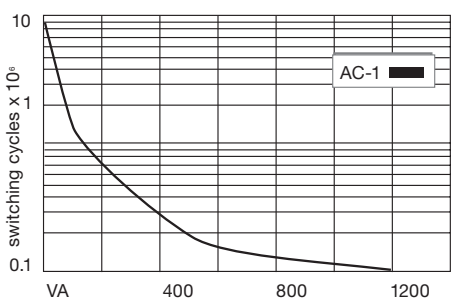
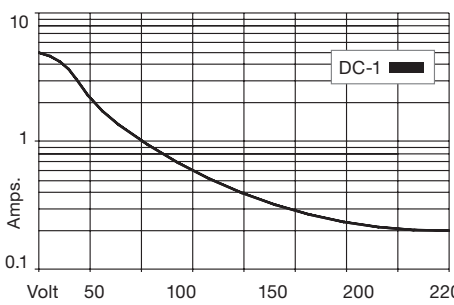
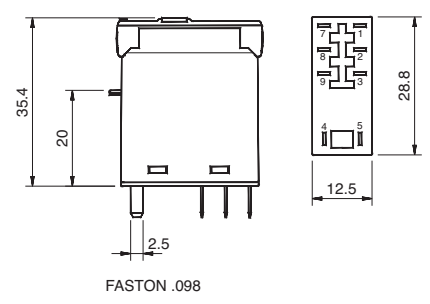

Fig. 2 DC load limit curve



Dimensions



Technical approvals, conformities



C12-G2x

2 pole | normally open contact | plug-in Faston

Maximum contact load	5 A/250 V AC-1	0.8 A/110 V DC-1
	5 A/30 V DC-1	0.4 A/220 V DC-1
Recommended minimum contact load	10 mA/10 V Code 1	
	5 mA/5 V Code 2	

Contacts

Material	Standard	Code 1	AgNi + 0.2 μ Au
	Optional	Code 2	AgNi + 5 μ Au
Rated Load	5 A		
Switch-on current max. (20 ms)	15 A		
Switching voltage max.	250 V		
AC load (Fig 1)	1.2 kVA		
DC load	see Fig. 2		

Coil

Coil resistance	see table; tolerance ± 10 %
Pick-up voltage	≥ 0.8 x U _N
Release voltage	≥ 0.1 x U _N
Nominal power	1.1 VA (AC)/0.7 W (DC)

Coil table

V AC	Ω	mA	VDC	Ω	mA
24	290	45	12	224	53
48	1200	23	24	742	32
115	7.300	9.5	48	3.500	13.7
230	28.800	4.7	110	19.900	5.5

Insulation

	Volt rms / 1 min
Contact open	2000 V
Contact/contact	3000 V
Contact/coil	5 kV
Insulation resistance at 500 V	≥1 GΩ
Insulation, IEC 61810-1	4 kV

Specifications

Ambient temperature operation/storage	-40 ... 60 °C / -40 ... 80 °C (no ice)
Pick-up time/bounce time	10 ms/≤ 1 ms
Release time/bounce time	5 ms/≤ 3 ms
Mechanical life ops	AC: 10 Mill./DC: 20 Mill.
DC voltage endurance at rated load	≥100 000 switching cycles
Switching frequency at rated load	≤ 1200/h
Weight	21 g

Product References

V AC 50 Hz/60 Hz: 24, 48, 115, (120), 230, (240)

LED

RC Suppressor

VDC 12, 24, 48, 110

LED

Polarity and free wheeling diode

AC/DC bridge rectifier 24 V, 48 V

Other voltages on request

C12-G21/AC ... V
C12-G21X/AC ... V
C12-G21R/AC ... V

C12-G22/AC ... V
C12-G22X/AC ... V
C12-G22R/AC ... V

C12-G21/DC ... V
C12G21X/DC ... V
C12-G21FX/DC ... V

C12-G22/DC ... V
C12-G22X/DC ... V
C12-G22FX/DC ... V

C12-G21BX/UC ... V

C12-G22BX/UC ... V

"..." List Coil Voltage to complete Product References

Accessories

Socket: **S12, S12-P**

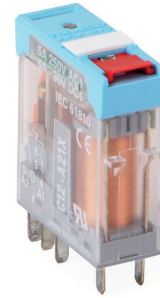

Connection diagram

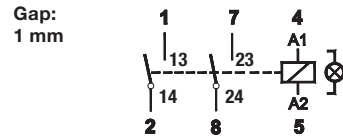

Fig.1 AC voltage endurance

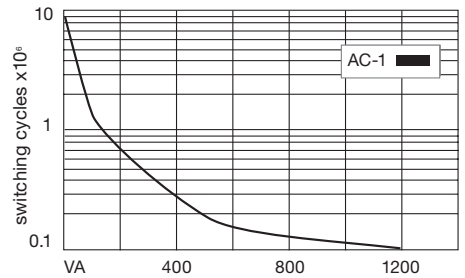
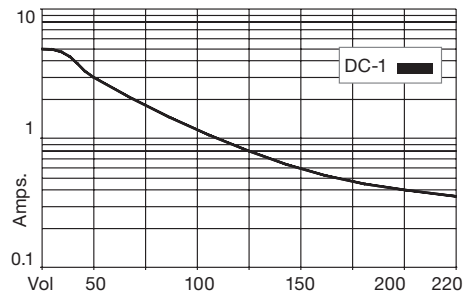
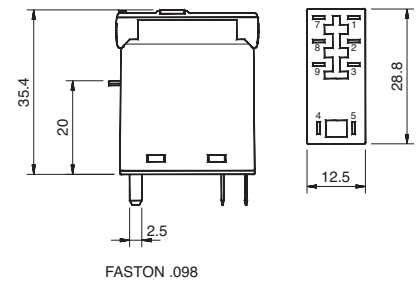

Fig. 2 DC load limit curve



Dimensions



Technical approvals, conformities



IEC/EN 61810; IEC/EN 60947

C16-A25PTL

2 pole | 8-pin | changeover contact | Grid 5mm



Maximum contact load	7 A/250V AC-1
	7 A/30V DC-1
Recommended minimum contact load	1 mA/1V AC/DC

Contacts	
Material	⚡ AgSnO ₂
Rated Load	7 A
Switching voltage max.	250V
Switch-on current max. (500ms)	15A
Bounce time	2 ms

Coil	
Coil resistance	see table; tolerance ± 10 %
Pick-up voltage	75 % of U _N (DC) / 80 % of U _N (AC)
Release voltage	≤ 0.1 U _N (DC) / ≤ 0.3 U _N (AC)
Nominal power	1 VA (AC) / 0.53 W (DC) @ 23 °C

Coil Data (DC voltage)

Coil Voltage Code	Nominal Voltage (V DC)	Coil Resistance (Ω) ± 10 %	Must operate voltage max. (VDC)	Must release voltage min (VDC)
12	12	270	9.00	1.2
24	24	1080	18.00	2.4
36	36	1350	27.00	3.6
48	48	4340	36.00	4.8
110	110	22830	82.5	11

Coil Data (AC voltage 50/60Hz)

Coil Voltage Code	Nominal Voltage (V AC)	Coil Resistance (Ω) ± 10 %	Must operate voltage max. (V AC)	Must release voltage min (V AC)	Max. allowable voltage (V AC)
24	24	253	19.2	7.2	26.4
110	110	5819	88.0	33	121
230	230	23276	184	69	253

Insulation

Insulation resistance (coil to contact)	≥ 100 MΩ @ 500V DC, 50 % RH
Dielectric strength	5 kV
Coil to contact	5000 Vrms, 1 min
Contact to contact	1000 Vrms, 1 min

Specifications

Ambient temperature operation/storage	-55 ... 70 °C / -55...70 °C (no ice)
Pick-up time	10ms
Release time	5 ms
Mechanical/ electrical life ops	≥ 1 × 10 000 000 / 1 × 100 000
Weight	17 g
Max. switching frequency	20Hz
Tightness	RT2
Weight	17 g

Product References

V AC 50 Hz/60 Hz: 24, 110 (120), 230 (240) **C16-A25PTL/AC...V**
VDC 12, 24, 48 **C16-A25PTL/DC...V**

Other voltages on request

"..." List Coil Voltage to complete Product References

Accessories

Socket	S16-M
Retaining clip, plastic	CP-16
Label	BS16-K (BAG 10 PCS)
Modules	See datasheet socket S16-M



Connection diagram

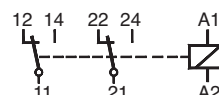
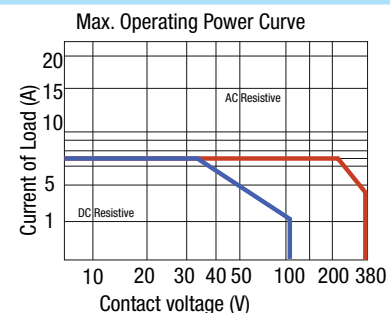
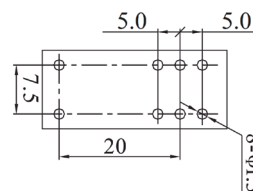
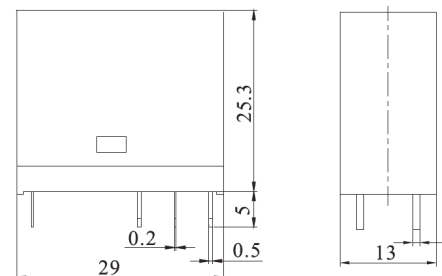

Fig.1 Max. Operating Power Curve



Dimensions



Technical approvals, conformities



C18-A15PT

1 pole | 5-pin | changeover contact | Grid 3.5mm

Maximum contact load	10 A/250V AC-1
	10 A/30V DC-1
Recommended minimum contact load	1 mA/1V AC/DC

Contacts

Material	⚡ AgSnO ₂
Rated Load	10 A
Switching voltage max.	250V
Switch-on current max. (500ms)	25 A
Bounce time	2 ms

Coil

Coil resistance	see table; tolerance ± 10 %
Pick-up voltage	75 % of U _N (DC) / 80 % of U _N (AC)
Release voltage	≤ 0.1 U _N (DC) / ≤ 0.3 U _N (AC)
Nominal power	1 VA (AC) / 0.53 W (DC) @ 23 °C

Coil Data (DC voltage)

Coil Voltage Code	Nominal Voltage (VDC)	Coil Resistance (Ω) ± 10 %	Must operate voltage max. (VDC)	Must release voltage min (VDC)
12	12	270	9.00	1.2
24	24	1080	18.00	2.4
36	36	1350	27.00	3.6
48	48	4340	36.00	4.8
110	110	22830	82.5	11

Coil Data (AC voltage 50/60 Hz)

Coil Voltage Code	Nominal Voltage (VAC)	Coil Resistance (Ω) ± 10 %	Must operate voltage max. (VAC)	Must release voltage min (VAC)	Max. allowable voltage (VAC)
24	24	253	19.2	7.2	26.4
110	110	5819	88.0	33	121
230	230	23276	184	69	253

Insulation

Insulation resistance (coil to contact)	≥ 100 MΩ @ 500V DC, 50% RH
Dielectric strength	5 kV
Coil to contact	5000Vrms, 1 min
Contact to contact	1000Vrms, 1 min

Specifications

Ambient temperature operation/storage	-55 ... 70 °C / -55...70 °C (no ice)
Pick-up time	10ms
Release time	5ms
Mechanical/electrical life ops	≥ 1 × 10 000 000 / 1 × 100 000
Weight	17g
Max. switching frequency	20Hz
Tightness	RT2
Weight	17 g

Product References

V AC 50 Hz/60 Hz: 24, 110 (120), 230 (240)
VDC 12, 24,36, 48, 110

C18-A15PT/AC...V
C18-A15PT/DC...V

Other voltages on request

"..." List Coil Voltage to complete Product References

Accessories

Socket	S18-M
Retaining clip, plastic	CP-16
Label	BS16-K (BAG 10 PCS)
Modules	See datasheet socket S18-M



Connection diagram

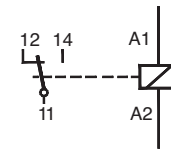
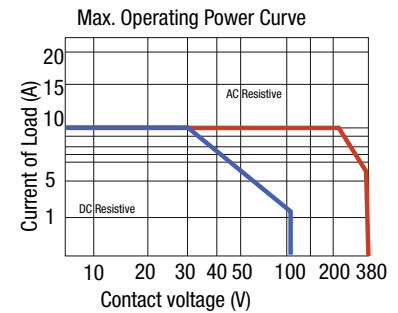
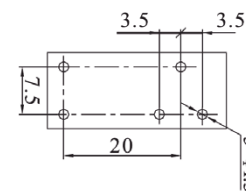
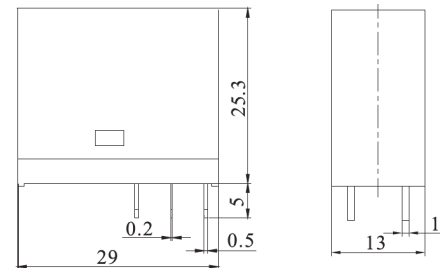

Fig.1 Max. Operating Power Curve



Dimension



Standard

Technical approvals, conformities



IEC/EN 61810; IEC/EN 60947

C18-A15PTL

1 pole | 5-pin | changeover contact | plug-in | Grid 5mm



Maximum contact load	10 A/250V AC-1
	10 A/30V DC-1
Recommended minimum contact load	1 mA/1V AC/DC

Contacts	
Material	⚡ AgSnO ₂
Rated Load	10A
Switching voltage max.	250V
Switch-on current max. (500ms)	25A
Bounce time	2 ms

Coil	
Coil resistance	see table; tolerance ± 10 %
Pick-up voltage	75 % of U _N (DC) / 80 % of U _N (AC)
Release voltage	≤ 0.1 U _N (DC) / ≤ 0.3 U _N (AC)
Nominal power	1 VA (AC) / 0.53 W (DC) @ 23 °C

Coil Data (DC voltage)					
Coil Voltage Code	Nominal Voltage (V DC)	Coil Resistance (Ω) ± 10 %	Must operate voltage max. (VDC)	Must release voltage min (VDC)	
12	12	270	9.00	1.2	
24	24	1080	18.00	2.4	
36	36	1350	27.00	3.6	
48	48	4340	36.00	4.8	
110	110	22830	82.5	11	

Coil Data (AC voltage 50/60Hz)					
Coil Voltage Code	Nominal Voltage (VAC)	Coil Resistance (Ω) ± 10 %	Must operate voltage max. (VAC)	Must release voltage min (VAC)	Max. allowable voltage (VAC)
24	24	253	19.2	7.2	26.4
110	110	5819	88.0	33	121
230	230	23276	184	69	253

Insulation	
Insulation resistance (coil to contact)	≥ 100 MΩ @ 500V DC, 50 % RH
Dielectric strength	5 kV
Coil to contact	5000 Vrms, 1 min
Contact to contact	1000 Vrms, 1 min

Specifications	
Ambient temperature operation/storage	-55 ... 70 °C / -55...70 °C (no ice)
Pick-up time	10ms
Release time	5 ms
Mechanical/electrical life ops	≥ 1 × 10 000 000 / 1 × 100 000
Weight	17g
Max. switching frequency	20Hz
Tightness	RT2
Weight	17 g

Product References	
V AC 50 Hz/60 Hz: 24, 110 (120), 230 (240)	C18-A15PTL/AC...V
VDC 12, 24, 36, 48, 110	C18-A15PTL/DC...V
Other voltages on request	

"..." List Coil Voltage to complete Product References

Accessories	
Socket	S16-M
Retaining clip, plastic	CP-16
Label	BS16-K (BAG 10 PCS)
Modules	See datasheet socket S16-M



Connection diagram

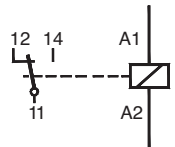
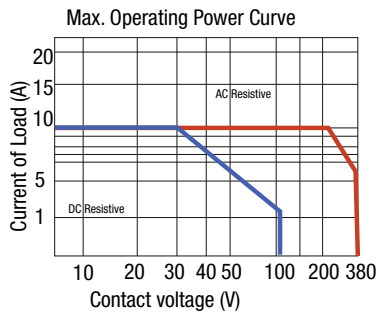
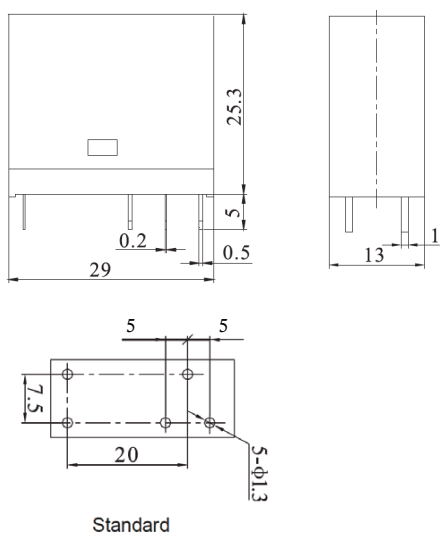

Fig.1 Max. Operating Power Curve



Dimensions



Technical approvals, conformities



C18-B15PTL

1 pole | 8-pin | changeover contact | Grid 5mm

Maximum contact load	16 A/250V AC-1
	16 A/30V DC-1
Recommended minimum contact load	1 mA/1V AC/DC

Contacts

Material	⚡ AgSnO ₂
Rated Load	16 A
Switching voltage max.	250V
Switch-on current max. (500ms)	25 A
Bounce time	2 ms

Coil

Coil resistance	see table; tolerance ± 10 %
Pick-up voltage	75 % of U _N (DC) / 80 % of U _N (AC)
Release voltage	≤ 0.1 U _N (DC) / ≤ 0.3 U _N (AC)
Nominal power	1 VA (AC) / 0.53 W (DC) @ 23 °C

Coil Data (DC voltage)

Coil Voltage Code	Nominal Voltage (VDC)	Coil Resistance (Ω) ± 10 %	Must operate voltage max. (VDC)	Must release voltage min (VDC)
12	12	270	9.00	1.2
24	24	1080	18.00	2.4
36	36	1350	27.00	3.6
48	48	4340	36.00	4.8
110	110	22830	82.5	11

Coil Data (AC voltage 50/60 Hz)

Coil Voltage Code	Nominal Voltage (VAC)	Coil Resistance (Ω) ± 10 %	Must operate voltage max. (VAC)	Must release voltage min (VAC)	Max. allowable voltage (VAC)
24	24	253	19.2	7.2	26.4
110	110	5819	88.0	33	121
230	230	23276	184	69	253

Insulation

Insulation resistance (coil to contact)	≥ 100 MΩ @ 500V DC, 50% RH
Dielectric strength	5 kV
Coil to contact	5000Vrms, 1 min
Contact to contact	1000Vrms, 1 min

Specifications

Ambient temperature operation/storage	-55 ... 70 °C / -55...70 °C (no ice)
Pick-up time	10ms
Release time	5ms
Mechanical/electrical life ops	≥ 1 × 10 000 000 / 1 × 100 000
Weight	17g
Max. switching frequency	20Hz
Tightness	RT2
Weight	17 g

Product References

V AC 50 Hz/60 Hz: 24, 110 (120), 230 (240)
 VDC 12, 24, 36, 48, 110

C18-B15PTL/AC...V
 C18-B15PTL/DC...V

Other voltages on request

"..." List Coil Voltage to complete Product References

Accessories

Socket	S16-M
Retaining clip, plastic	CP-16
Label	BS16-K (BAG 10 PCS)
Modules	See datasheet socket S16-M



Connection diagram

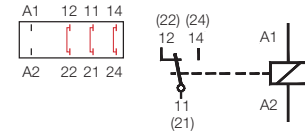

⚠ When switching over 10 A, it is necessary to add jumpers between the terminals on the relay socket S16-M. Jumper terminals; 22-12, 21-11 and 24-14. The resulting schematic is above.

Fig.1 Max. Operating Power Curve

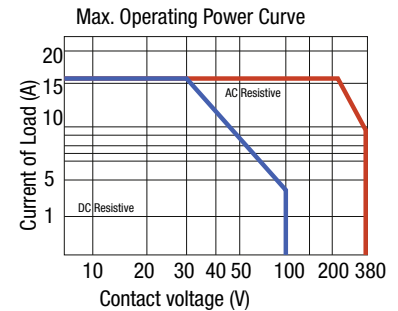

Dimensions

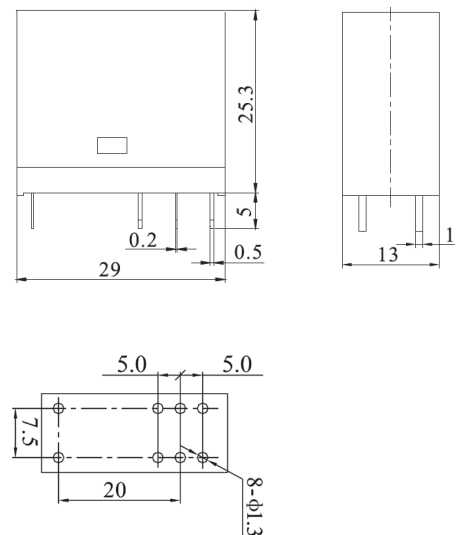





Technical approvals, conformities



IEC/EN 61810; IEC/EN 60947

1.2 Interface Relays

Application	Types	Contacts	AC ratings	DC ratings
CRINT Series				
High power contact AgSnO ₂	CRINT-1x1		6 A / 250 V	6 A / 30 V
Low power contact AgSnO ₂ + 3μ Au	CRINT-1x2		6 A / 250 V	6 A / 30 V
DC solid state switch	CRINT-1x5 (see page 82)		-	2 A / 24 V
AC solid state switch	CRINT-1x8 (see page 83)		1 A / 240 V	-

CRINT Product Key

1		2	3	4	5	6	7	8	
CRINT	-	C	1	1	1	R	/	UC	24V

1. Product family

CRINT

2. Type

C = Combined version (Socket and Relay)

3. Contact

1 = One change-over contact

4. Connection type

1 = Screw terminal
2 = Cage clamp terminal

5. Output

1 = AgSnO₂
2 = AgSnO₂ + 3μ Au
5 = NO / Solid-state DC
8 = NO / Solid-state AC

6. Options

- = Standard version
R = Railway version

7. Supply voltage

UC = AC/DC
DC = Only for C1x5 and C1x8

8. Nominal voltage

12V, 24V, 48V, 60V, 110-125V, 220-240V

RELAY Only

1		2	3	4	5
CRINT	-	R	11	DC	12V

1. Product family

CRINT

2. Type

R = Relay

3. Contact

11 = AgSnO₂
12 = AgSnO₂ + 3μ Au
15 = NO / Solid-state DC
18 = NO / Solid-state AC

4. Supply voltage

DC

5. Nominal voltage

12 V, 24 V, 48 V, 60 V*

*60 V Relay used for all sockets with a nominal voltage higher or equal 60V

Dimensions [mm]

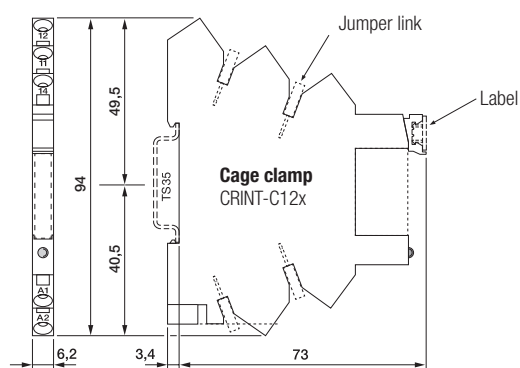
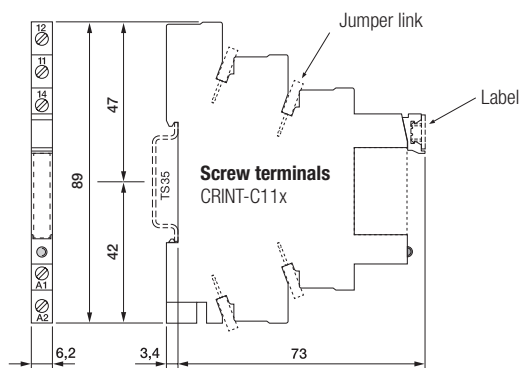

Max. contact load	6 A, 250 V AC-1	6 A, 30 V DC-1
Contact		
Type	1 CO	
Material	⚡ AgSnO ₂	
Switching current _{TH}	6 A 250 V AC	
Recommended minimal load	100 mA / 12 V	
Switching power DC-1 30 V	180 W	
Switching power AC-1 230 V	1500 VA	
Switching power AC-15 230 V	300 VA	
Peak inrush current	15 A/2.5 ms	

Coil		
Operation voltage AC 50/60 Hz / DC	0.8 ... 1.25 U _N	
Nominal power DC/AC	408 / 900 mW	

Insulation		
Test voltage I / O	6 kV rms / 1 min	
Pollution degree	3	
Over voltage category	III	
Open contact	1000 Vrms dielectric strength 1 min	
Standard	EN61810-5	

Specifications		
Ambient temperature: operation / storage	-40 ... +70 °C / -40 ... +85 °C (no ice)	
Typical response time @ V _n	7 ms	
Typical release time @ V _n	15 ms	
Switching cycles: mech./elec.	10 x 1 000 000 / 3 x 10 000	
Cond. cross section screw terminal	2.5 mm ²	
Cond. cross section spring cage	0.75 ... 2.5 mm ²	
Protection degree	IP 20	
Mounting position	any, TS35 or Back Panel Mounting	
Housing material	Polyamide PA6	
Weight	30 g	

Product References		
Screw terminal:	CRINT-C111/UC...V	UC12V UC24V UC48V UC60V UC110-125V UC220-240V
Cage clamp terminal:	CRINT-C121/UC...V	
"..." List Coil Voltage to complete Product References		

Accessories		
Jumper link:	blue:	CRINT-BR20-BU (BAG 5 PCS)
	red:	CRINT-BR20-RD (BAG 5 PCS)
	black:	CRINT-BR20-BK (BAG 5 PCS)

Label plate:	CRINT-LAB (BAG 4x16 PCS)
Spacer:	CRINT-SEP (BAG 5 PCS)

Replacement relays:		
CRINT-R11/DC...V		
"..." List Coil Voltage to complete Product References		DC12V DC24V DC48V DC60V*
*60V Relay used for all sockets with a nominal voltage higher or equal 60V		

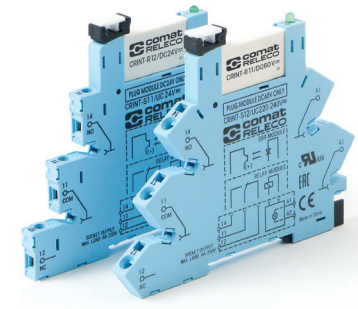

Connection diagram

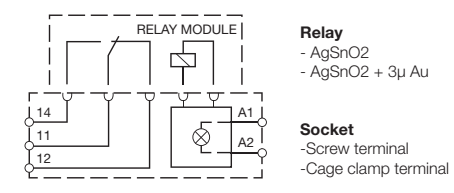

Fig.1 AC voltage endurance

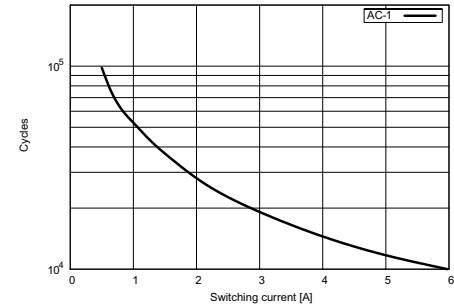
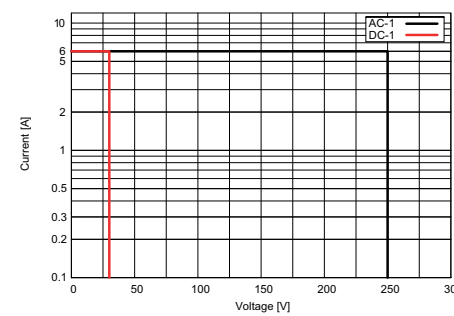

Fig. 2 DC load limit curve



Dimensions p. 30

Technical approvals, conformities



1.2 Interface Relays
CRINT 1x2 series
1 pole | changeover contact

Max. contact load	6 A, 250 V AC-1	6 A, 30 V DC-1
Contact		
Type	1 CO	
Material	AgSnO ₂ + 5μ Au	
Switching current _{TH}	6 A 250 V AC	
Recommended minimal load	10 mA / 6 V	
Switching power DC-1 30 V	180 W	
Switching power AC-1 230 V	1500 VA	
Switching power AC-15 230 V	300 VA	
Peak inrush current	15 A/2.5 ms	
Coil		
Operation voltage AC 50/60 Hz / DC	0.8 ... 1.25 U _N	
Nominal power DC/AC	408 / 900 mW	
Insulation		
Test voltage I / O	6 kV rms / 1 min	
Pollution degree	3	
Over voltage category	III	
Open contact	1000 Vrms dielectric strength 1 min	
Standard	EN61810-5	
Specifications		
Ambient temperature: operation / storage	-40 ... +70 °C / -40 ... +85 °C (no ice)	
Typical response time @ V _n	7 ms	
Typical release time @ V _n	15 ms	
Switching cycles: mech./elec.	10 x 1 000 000 / 3 x 10 000	
Cond. cross section screw terminal	2.5 mm ²	
Cond. cross section spring cage	0.75 ... 2.5 mm ²	
Protection degree	IP 20	
Mounting position	any, TS35 or Back Panel Mounting	
Housing material	Polyamide PA6	
Weight	30 g	

Product References		
Screw terminal:	CRINT-C112/UC...V	UC12V UC24V UC48V UC60V UC110-125V UC220-240V
Cage clamp terminal:	CRINT-C122/UC...V	
"..." List Coil Voltage to complete Product References		

Accessories		
Jumper link:	blue:	CRINT-BR20-BU (BAG 5 PCS)
	red:	CRINT-BR20-RD (BAG 5 PCS)
	black:	CRINT-BR20-BK (BAG 5 PCS)
Label plate:		CRINT-LAB (BAG 4x16 PCS)
Spacer:		CRINT-SEP (BAG 5 PCS)

Replacement relays:
CRINT-R12/DC...V
 "... " List Coil Voltage to complete Product References

*60V Relay used for all sockets with a nominal voltage higher or equal 60V

- DC12V**
- DC24V**
- DC48V**
- DC60V***

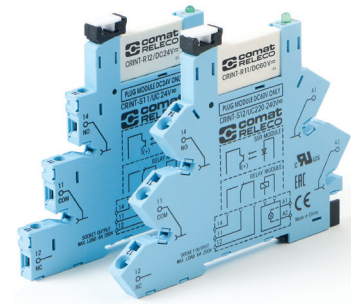

Connection diagram

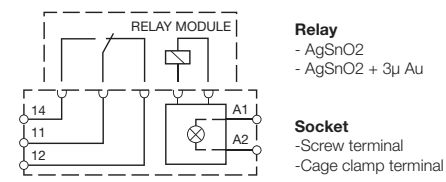

Fig.1 AC voltage endurance

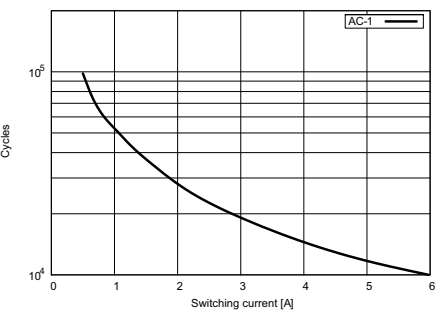
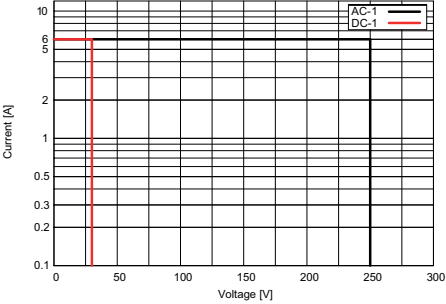

Fig. 2 DC load limit curve











Dimensions p. 30

Technical approvals, conformities

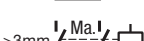

1.3 Industrial Relays - pluggable

Application	Types	Pins	Contacts	AC ratings	DC ratings	Socket
C2 Series						
General purpose	C2-A2x			10 A / 250 V	0.5 A / 110 V	S2
C3 Series						
General purpose	C3-A3x			10 A / 250 V	0.5 A / 110 V	S3
Low switching load	C3-T3x			6 A / 250 V	6 A / 30 V	S3
DC load switching	C3-G3x		1.7mm	10 A / 250 V	1.2 A / 110 V	S3
DC load switching with magnetic blow out	C3-M1x		>3mm	10 A / 250 V	10 A / 220 V	S3
DC load switching double make	C3-X1x		>3mm	10 A / 250V	7 A / 110 V	S3
Latching relay	C3-R2x			10 A / 250 V	0.5 A / 110 V	S3
Sensitive coil 800 mW	C3-N3x			10 A / 250 V	0.5 A / 110 V	S3
C4 Series						
General purpose	C4-A4x			10 A / 250 V	0.5 A / 110 V	S4
DC load switching double make	C4-X2x		2x >3mm	10 A / 250 V	7 A / 110 V	S4
Latching relay	C4-R3x			10 A / 250 V	0.5 A / 110 V	S4

Application	Types	Pins	Contacts	AC ratings	DC ratings	Socket
C5 Series						
Power relay	C5-A2x			16 A / 400 V	0.5 A / 110 V	S5
Power relay	C5-A3x			16 A / 400 V	0.5 A / 110 V	S5
DC load switching	C5-G3x		1.7mm 	16 A / 400 V	1.2 A / 110 V	S5
DC load switching double make	C5-X1x		>3mm 	16 A / 400 V	7 A / 110 V	S5
DC load switching with magnetic blow out	C5-M1x		>3mm 	16 A / 400 V	10 A / 220 V	S5
DC load switching with magnetic blow out	C5-M2x		>3mm 	16 A / 250 V	7 A / 110 V	S5
Latching relay	C5-R2x		 Rem.	10 A / 400 V	10 A / 30 V	S5
C7 Series						
Miniature power relay	C7-A1x			16 A / 250 V	0.5 A / 110 V	S7
General purpose	C7-A2x			10 A / 250 V	0.5 A / 110 V	S7
Low switching load	C7-T2x			6 A / 250 V	6 A / 30 V	S7
DC load switching	C7-G2x			10 A / 250 V	0.8 A / 110 V	S7
General purpose and low switching load	C7-H2x			10 A / 250 V	10 A / 30 V	S7
DC load switching double make	C7-X1x		>3mm 	10 A / 250 V	6 A / 110 V	S7
Power relay for high inrush current	C7-W1x			10 A / 250 V	–	S7
C9 Series						
Miniature relay	C9-A4x			5 A / 250 V	5 A / 30 V	S9
Sensitive Coil 500mW ... 800mW	C9-E2x			5 A / 250 V	5 mA / 30 V	S9
Latching relay	C9-R2x			5 A / 120 V	5 A / 30 V	S9

C2-A2x

2 pole | changeover contact | plug-in

Maximum contact load	10 A/250 V AC-1	0.5 A/110 V DC-1
	10 A/30 V DC-1	0.2 A/220 V DC-1
Recommended minimum contact load	10 mA/10 V Code 0	
	5 mA/5 V Code 8	

Contacts

Material	Standard	Code 0	AgNi
	Optional	Code 8	AgNi + 5 μ Au
Max. switching current	10 A		
Max. peak inrush current (20 ms.)	30 A		
Max. switching voltage	250 V		
Max. AC load (Fig 1 1)	2.5 kVA		
Max. DC load	See Fig 2		

Coils

Coil resistance	see table; tolerance ± 10 %
Pick up voltage	≤ 0.8 × U _N
Pick up voltage	≥ 0.1 × U _N
Nominal power	2.2 VA (AC)/1.3 W (DC)

Table

V AC	Ω	mA	VDC	Ω	mA
24	67	92	24	443	54
48	296	46	48	1K8	27
115	1K7	19	110	9K	12
230	7K1	9.5	220	36K1	6

Insulation

	Volt rms / 1 min
Open contact	1000 V
Between adjacent poles	2.5 kV
Between contacts and coil	2.5 kV
Insulation resistance at 500 V	≥ 1 GΩ
Insulation, IEC 61810-1	2.5 kV

Specifications

Ambient temperature operation/storage	-40...60 °C / -40 ... 80 °C (no ice)
Pick-up time + bounce time	16 ms/≤ 3 ms
Release time + bounce time	8 ms/≤ 1 ms
Mechanical life ops	AC: 10 Mill./DC: 20 Mill.
DC voltage endurance at rated load	≥ 100 000 ops. switching cycles
Operating frequency at nominal load	≤ 1200/ops/h
Weight	79 g

Product References

V AC 50 Hz/60 Hz: 24, 48, 115 (120), 230 (240)

LED

RC Suppressor

VDC 24, 48, 110, 220

LED

Free wheeling diode

Polarity and free wheeling diode

AC/DC bridge rectifier 24 V, 48 V, 60 V

Other voltages on request

C2-A20/AC ... V	C2-A28/AC ... V
C2-A20X/AC ... V	C2-A28X/AC ... V
C2-A20R/AC ... V	C2-A28R/AC ... V
C2-A20/DC ... V	C2-A28/DC ... V
C2-A20X/DC ... V	C2-A28X/DC ... V
C2-A20DX/DC ... V	C2-A28DX/DC ... V
C2-A20FX/DC ... V	C2-A28FX/DC ... V
C2-A20BX/UC ... V	C2-A28BX/UC ... V

"..." List Coil Voltage to complete Product References

Accessories (See also Section Sockets)

Socket:	S2-B, S2-PO
Blanking Plug:	SO-NP (BAG 10 PCS)

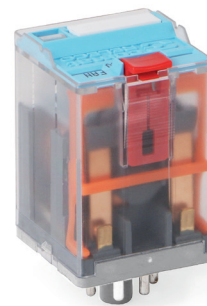

Connection diagram

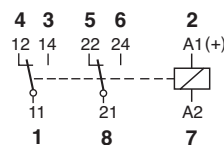

Fig.1 AC voltage endurance

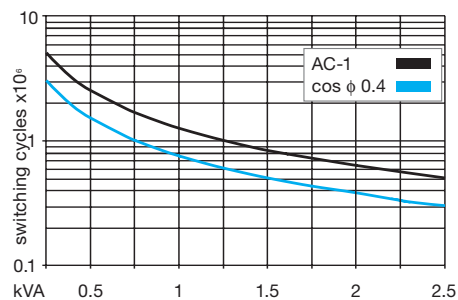
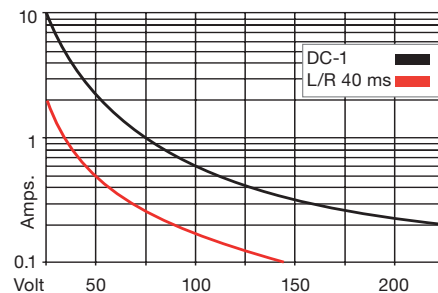
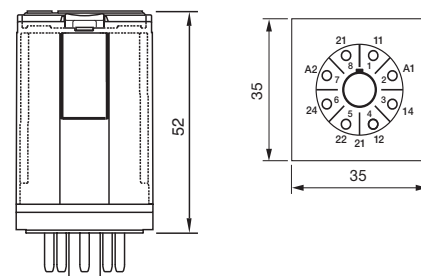

Fig. 2 DC load limit curve



Dimensions



Technical approvals, conformities



C3-A3x

3 pole | changeover contact | plug-in

Maximum contact load	10 A/250	AC-1	0.5 A/110 V	DC-1
	10 A/30	DC-1	0.2 A/220 V	DC-1
Recommended minimum contact load	10 mA/10 V	Code 0, 9		
	5 mA/5 V	Code 8		

Contacts

Material	Standard	Code 0	⚡ AgNi
	Optional	Code 8	⚡ AgNi + 5 μ Au
	Optional	Code 9	⚡ AgNi + 0.2 μ Au
Rated Load			10 A
Switch-on current max. (20 ms)			30 A
Switching voltage max.			250 V
AC load (Fig 1)			2.5 kVA
DC load			see Fig. 2

Coil

Coil resistance	see table; tolerance ± 10 %
Pick-up voltage	≤ 0.8 x U _N
Release voltage	≥ 0.1 x U _N
Nominal power	2.2 VA (AC)/1.3 W (DC)

Coil table

V AC	Ω	mA	VDC	Ω	mA
24	67	92	24	480	50
48	296	46	48	1K8	26
115	1K7	19	110	9K	12
230	7K1	9.5	220	36K1	6

Insulation

	Volt rms / 1 min
Contact open	1000 V
Contact/contact	2.5 kV
Contact/coil	2.5 kV
Insulation resistance at 500 V	≥ 1 GΩ
Insulation, IEC 61810-1	2.5 kV

Specifications

Ambient temperature operation/storage	-40...60 °C / -40 ... 80 °C (no ice)
Pick-up time/bounce time	16 ms/≤ 3 ms
Release time/bounce time	8 ms/≤ 1 ms
Mechanical life ops	AC: 10 Mill./DC: 20 Mill.
DC voltage endurance at rated load	≥ 100 000 switching cycles
Switching frequency at rated load	≤ 1200/ops/h
Weight	81 g

Product References

V AC 50 Hz/60 Hz: 24, 48, 115 (120), 230 (240)

LED

RC Suppressor

VDC 24, 48, 110, 220

LED

Free wheeling diode

Polarity and free wheeling diode

AC/DC bridge rectifier 24 V, 48 V, 60 V

Other voltages on request

C3-A30/AC ... V	C3-A38/AC ... V	C3-A39/AC ... V
C3-A30X/AC ... V	C3-A38X/AC ... V	C3-A39X/AC ... V
C3-A30R/AC ... V	C3-A38R/AC ... V	C3-A39R/AC ... V
C3-A30/DC ... V	C3-A38/DC ... V	C3-A39/DC ... V
C3-A30X/DC ... V	C3-A38X/DC ... V	C3-A39X/DC ... V
C3-A30DX/DC ... V	C3-A38DX/DC ... V	C3-A39DX/DC ... V
C3-A30FX/DC ... V	C3-A38FX/DC ... V	C3-A39FX/DC ... V
C3-A30BX/UC ... V	C3-A38BX/UC ... V	C3-A39BX/UC ... V

"..." List Coil Voltage to complete Product References

Accessories (See also Section Sockets)

Socket:	S3-B, S3-S, S3-L, S3-PO, S3-MB0, S3-MB1
Blanking Plug:	SO-NP (BAG 10 PCS)

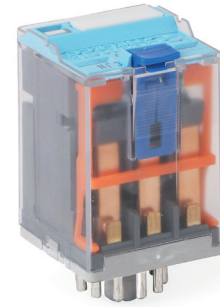

Connection diagram

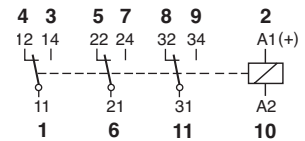

Fig.1 AC voltage endurance

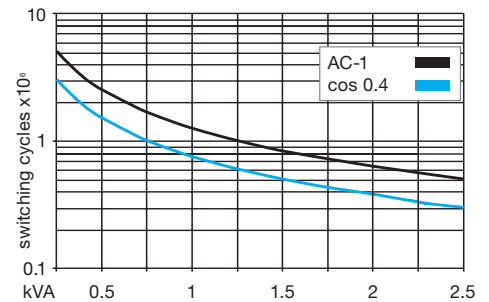
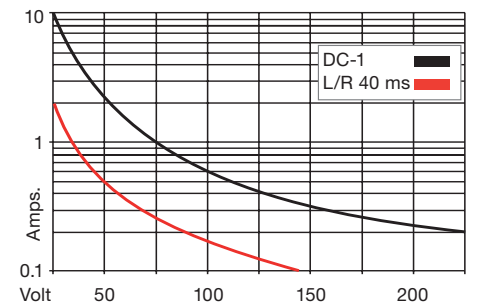
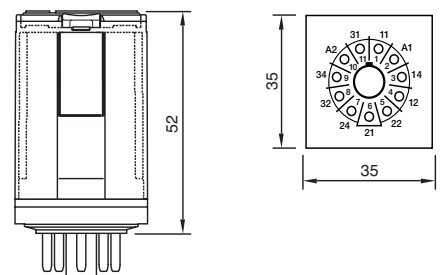

Fig. 2 DC load limit curve



Dimensions



Technical approvals, conformities



IEC/EN 61810; IEC/EN 60947

C3-T3x

3 pole | changeover twin contact | plug-in

Maximum contact load	6 A/250 V AC-1	6 A/30 V DC-1
Recommended minimum contact load	5 mA/5 V Code 1	1 mA/5 V Code 2

Contacts

Material	Standard	Code 1	AgNi + 0.2 μ Au
	Optional	Code 2	AgNi + 5 μ Au
Rated Load			6 A
Switch-on current max. (20 ms)			15 A
Switching voltage max.			250 V
AC load (Fig 1)			1.2 kVA
DC load			see Fig. 2

Coil

Coil resistance	see table; tolerance ± 10 %
Pick-up voltage	≤ 0.8 × U _N
Release voltage	≥ 0.1 × U _N
Nominal power	2.2 VA (AC)/1.3 W (DC)

Coil table

V AC	Ω	mA	VDC	Ω	mA
24	67	92	24	480	50
48	296	46	48	1K8	26
115	1K7	19	110	9K	12
230	7K1	9.5	220	36K1	6

Insulation

	Volt rms / 1 min
Contact open	1000 V
Contact/contact	2.5 kV
Contact/coil	2.5 kV
Insulation resistance at 500 V	≥ 1 GΩ
Insulation, EN 61810-1	2.5 kV

Specifications

Ambient temperature operation/storage	-40 ... 70 °C / -40 ... 80 °C (no ice)
Pick-up time/bounce time	8 ms/≤ 3 ms
Release time/bounce time	18 ms/≤ 1 ms
Mechanical life ops	AC: 10 Mill./DC: 20 Mill.
DC voltage endurance at rated load	≥ 100 000 switching cycles
Switching frequency at rated load	≤ 1200/ops/h
Weight	81 g

Product References

V AC 50 Hz/60 Hz: 24, 48, 115 (120), 230 (240)

LED

RC Suppressor

VDC 24, 48, 110, 220

LED

Free wheeling diode

Polarity and free wheeling diode

AC/DC bridge rectifier 24 V, 48 V, 60 V

Other voltages on request

C3-T31/AC ... V
C3-T31X/AC ... V
C3-T31R/AC ... V

C3-T32/AC ... V
C3-T32X/AC ... V
C3-T32R/AC ... V

C3-T31/DC ... V
C3-T31X/DC ... V
C3-T31DX/DC ... V
C3-T31FX/DC ... V

C3-T32/DC ... V
C3-T32X/DC ... V
C3-T32DX/DC ... V
C3-T32FX/DC ... V

C3-T31BX/UC ... V

C3-T32BX/UC ... V

"..." List Coil Voltage to complete Product References

Accessories (See also Section Sockets)

Socket:

Blanking Plug:

S3-B, S3-S, S3-L, S3-PO, S3-MB0, S3-MB1
SO-NP (BAG 10 PCS)

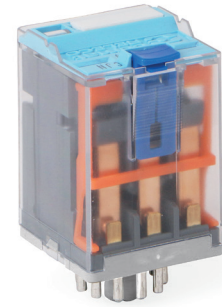

Connection diagram

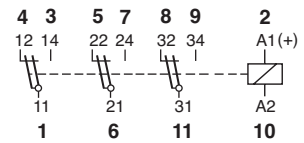

Fig.1 AC voltage endurance

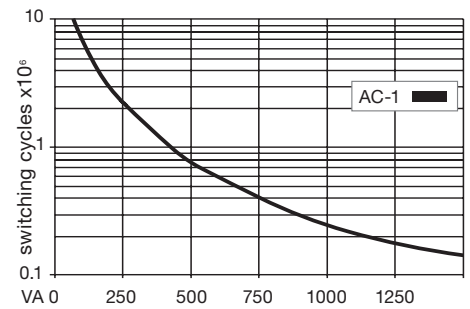
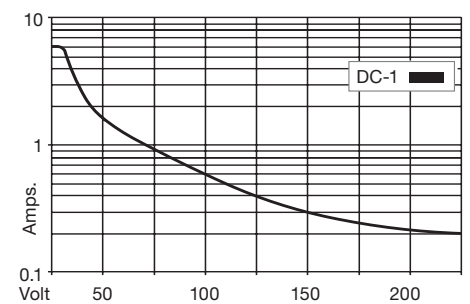
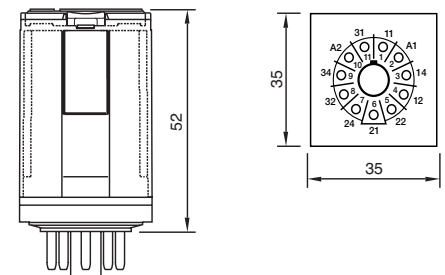

Fig. 2 DC load limit curve



Dimensions



Technical approvals, conformities



IEC/EN 61810; IEC/EN 60947

C3-G3x

3 pole | normally open contact | plug-in

Maximum contact load	10 A 250 V AC-1	1.2 A/110 V DC-1
	10 A 30 V DC-1	0.4 A/220 V DC-1

Contacts

Material	Standard	Code 0	⚡ AgNi
Rated Load			10 A
Switch-on current max. (20 ms)			30 A
Switching voltage max.			250 V
AC load (Fig 1)			2.5 kVA
DC load			see Fig. 2

Coil

Coil resistance	see table; tolerance ± 10 %
Pick-up voltage	≤ 0.8 × U _N
Release voltage	≥ 0.1 × U _N
Nominal power	2.4 VA (AC)/1.6 W (DC)

Coil table

V AC	Ω	mA	VDC	Ω	mA
24	65	100	24	360	66
48	286	50	48	1K4	34
115	1K7	21	110	7K6	15
230	6K8	10	220	30K3	7.5

Insulation

Insulation	Volt rms / 1 min
Contact open	2000 V
Contact/contact	2.5 kV
Contact/coil	2.5 kV
Insulation resistance at 500 V	≥ 1 GΩ
Insulation, IEC 61810-1	2.5 kV

Specifications

Ambient temperature operation/storage	-40...60 °C / -40 ... 80 °C (no ice)
Pick-up time/bounce time	20 ms/≤ 3 ms
Release time/bounce time	8 ms/≤ 1 ms
Mechanical life ops	AC: 10 Mill./DC: 20 Mill.
DC voltage endurance at rated load	≥ 100 000 switching cycles
Switching frequency at rated load	≤ 1200/ops/ h
Weight	81 g

Product References

V AC 50 Hz/60 Hz: 24, 48, 115 (120), 230 (240)

LED

RC Suppressor

VDC 24, 48, 110, 220

LED

Free wheeling diode

Polarity and free wheeling diode

AC/DC bridge rectifier 24 V, 48 V, 60 V

Other voltages on request

C3-G30/AC ... V
C3-G30X/AC ... V
C3-G30R/AC ... V

C3-G30/DC ... V
C3-G30X/DC ... V
C3-G30DX/DC... V
C3-G30FX/DC ... V

C3-G30BX/UC ... V

"..." List Coil Voltage to complete Product References

Accessories (See also Section Sockets)

Socket:

S3-B, S3-S, S3-L, S3-PO, S3-MB0, S3-MB1

Blanking Plug:

SO-NP (BAG 10 PCS)

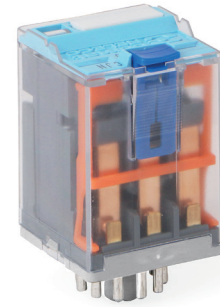

Connection diagram

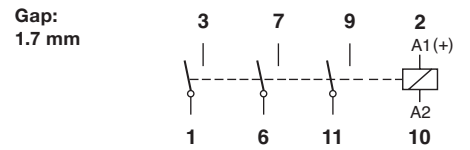

Fig.1 AC voltage endurance

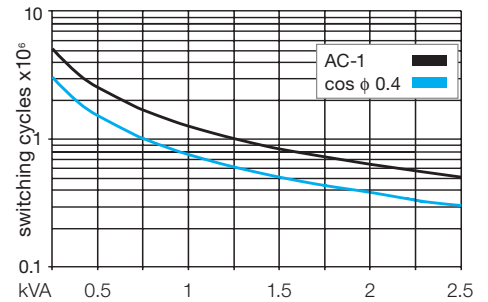
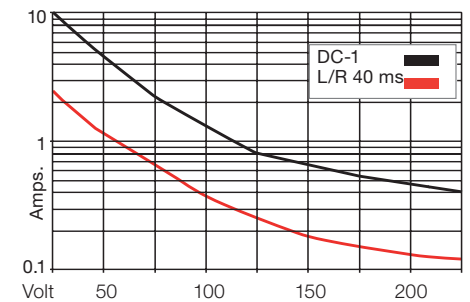
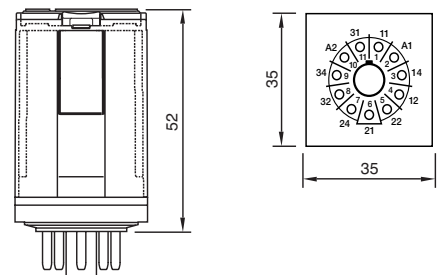

Fig. 2 DC load limit curve



Dimensions



Technical approvals, conformities



IEC/EN 61810; IEC/EN 60947

C3-M1x

1 pole | normally open serial contact with blow magnet | plug-in



Maximum contact load	10 A 250 V AC-1	10 A 220 V DC-1
-----------------------------	------------------------	------------------------

Contacts

Material	Standard	Code 0	⚡ AgNi
Rated Load			10 A
Switch-on current max. (20 ms)			30 A
Switching voltage max.			250 V
AC load (Fig 1)			2.5 kVA
DC load			see Fig. 2

Coil

Coil resistance	see table; tolerance ± 10 %
Pick-up voltage	≤ 0.8 x U _N
Release voltage	≥ 0.1 x U _N
Nominal power	2.4 VA (AC) / 1.3 W (DC)

Coil table

V AC	Ω	mA	VDC	Ω	mA
24	65	100	24	480	50
48	286	50	48	1K8	26
115	1K7	21	110	9K	12
230	6K8	10	220	29K	7.5

Insulation

Contact open	Volt rms / 1 min
Contact/contact	2500 V
Contact/coil	2.5 kV
Insulation resistance at 500 V	≥ 1 GΩ
Insulation, IEC 61810-1:	2.5 KV

Specifications

Ambient temperature operation/storage	-40 ... 70 °C (55° C AC) / -40 ... 80 °C (no ice)
Pick-up time/bounce time	20 ms/≤ 3 ms
Release time/bounce time	10 ms/≤ 1 ms
Mechanical life ops	AC: 10 Mill./DC: 20 Mill.
DC voltage endurance	see fig. 2
Switching frequency at rated load	≤ 1200/h
Weight	90 g

Product References

V AC 50 Hz/60 Hz: 24, 48, 115 (120), 230 (240)

LED

RC Suppressor

VDC 24, 48, 110, 220

LED

Free wheeling diode

Polarity and free wheeling diode

AC/DC bridge rectifier 24 V, 48 V, 60 V

Other voltages on request

"..." List Coil Voltage to complete Product References

Accessories (See also Section Sockets)

Socket:

S3-B, S3-S, S3-L, S3-PO, S3-MB0, S3-MB1

Blanking Plug:

SO-NP (BAG 10 PCS)

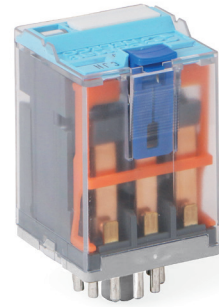

Connection diagram

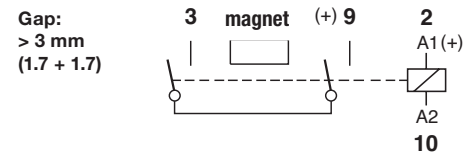

Fig.1 AC voltage endurance

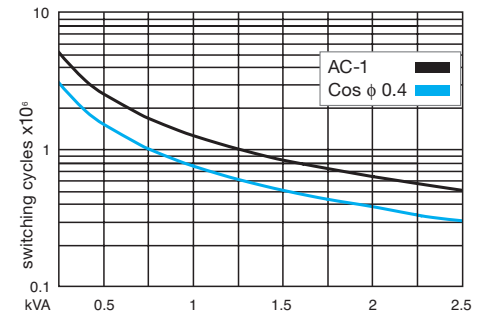
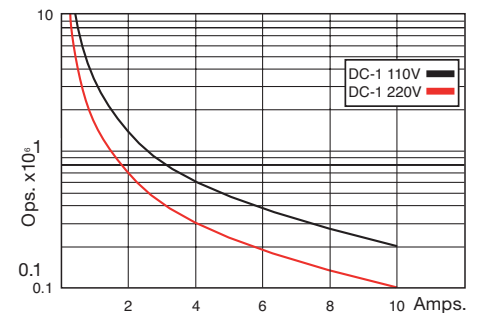
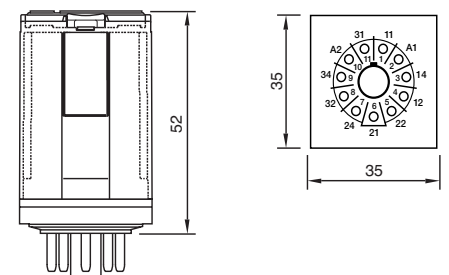

Fig. 2 DC voltage endurance



Dimensions



Technical approvals, conformities



IEC/EN 61810; IEC/EN 60947

C3-X1x

1 pole | normally open serial contact | plug-in

Maximum contact load	10 A/250 V AC-1	7 A/110 V DC-1
	10 A/30 V DC-1	1.2 A/220 V DC-1

Contacts

Material	Standard	Code 0	⚡ AgNi
Rated Load			10 A
Switch-on current max. (20 ms)			30 A
Switching voltage max.			250 V
AC load (Fig 1)			2.5 kVA
DC load			see Fig. 2

Coil

Coil resistance	see table; tolerance ± 10 %
Pick-up voltage	≤ 0.8 × U _N
Release voltage	≥ 0.1 × U _N
Nominal power	2.4 VA (AC)/1.3 W (DC)

Coil table

V AC	Ω	mA	VDC	Ω	mA
24	65	100	24	480	54
48	286	50	48	1K8	26
115	1K7	21	110	9K	12
230	6K8	10	220	29K	7.5

Insulation

Contact open	Volt rms / 1 min
Contact/contact	2500 V
Contact/coil	2.5 kV
Insulation resistance at 500 V	≥ 1 GΩ
Insulation, IEC 61810-1	2.5 kV

Specifications

Ambient temperature operation/storage	-40...60 °C / -40 ... 80 °C (no ice)
Pick-up time/bounce time	18 ms/≤ 3 ms
Release time/bounce time	8 ms/≤ 1 ms
Mechanical life ops	AC: 10 Mill./DC: 20 Mill.
DC voltage endurance at rated load	≥ 100 000 switching cycles
Switching frequency at rated load	≤ 1200/ops/h
Weight	83 g

Product References

V AC 50 Hz/60 Hz: 24, 48, 115 (120), 230 (240)

LED

RC Suppressor

VDC 24, 48, 110, 220

LED

Free wheeling diode

Polarity and free wheeling diode

AC/DC bridge rectifier 24 V, 48 V, 60 V

Other voltages on request

"..." List Coil Voltage to complete Product References

Accessories (See also Section Sockets)

Socket:

Blanking Plug:

**S3-B, S3-S, S3-L, S3-PO, S3-MB0, S3-MB1
SO-NP (BAG 10 PCS)**

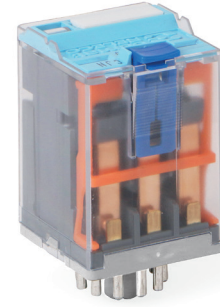

Connection diagram

Gap:
> 3 mm
(1.7 + 1.7)

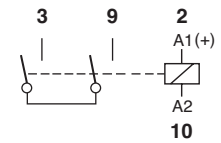

Fig.1 AC voltage endurance

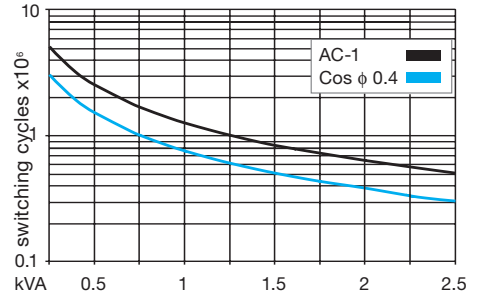
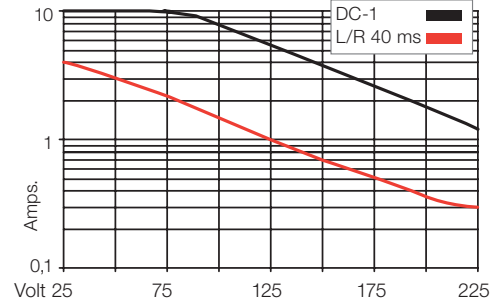
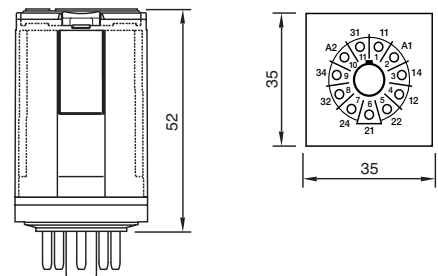

Fig. 2 DC load limit curve



Dimensions



Technical approvals, conformities



IEC/EN 61810; IEC/EN 60947

C3-R2x

2 pole | changeover contact | retentive | plug-in



Maximum contact load	10 A/250 V AC-1	0.5 A/110 V DC-1
	10 A/30 V DC-1	0.2 A/220 V DC-1
Recommended minimum contact load	10 mA/10 V Code 0	
	5 mA/5 V Code 8	

Contacts

Material	Standard	Code 0	⚡ AgNi
	Optional	Code 8	⚡ AgNi + 5 μ Au

Rated Load	10 A
Switch-on current max. (20 ms)	30 A
Switching voltage max.	250 V
AC load (Fig 1)	2.5 kVA
DC load	see Fig. 2

Coil

Coil resistance	see table; tolerance ± 10 %
ON pulse power	1.5 VA/W
OFF pulse power	0.5 VA/W
Pull-in ON/OFF	≤ 0.8 × U _N

Internal Diagram:

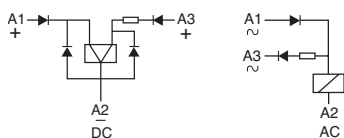

Coil table

V AC	mA ON	mA OFF	VDC	mA ON	mA OFF
24	75	12	12	125	41
48	38	6	24	63	21
115	16	2.5	48	31	10
230	8	1.3	110	14	4.5

Insulation

	Volt rms / 1 min
Contact open	1000 V
Contact/contact	2.5 kV
Contact/coil	2.5 kV
Insulation resistance at 500 V	≥ 1 G.Ω
Insulation, IEC 61810-1	2.5 kV

Specifications

Ambient temperature operation/storage	-40...60 °C / -40 ... 80 °C (no ice)
Minimum pulse length for ON/OFF	50 ms
Mechanical life ops	10 Mill.
DC voltage endurance at rated load	≥ 100 000 switching cycles
Switching frequency at rated load	≤ 1200/ops/h
Weight	81 g

Product References

V AC 50 Hz/60 Hz: 24, 48, 115, 230

C3-R20N/AC ... V C3-R28N/AC ... V

VDC 12, 24, 48, 110

C3-R20N/DC ... V C3-R28N/DC ... V

Other voltages on request

"..."List Coil Voltage to complete Product References

Accessories (See also Section Sockets)

Socket: **S3-B, S3-S, S3-L, S3-PO, S3-MB0, S3-MB1**
 Blanking Plug: **SO-NP (BAG 10 PCS)**



Connection diagram

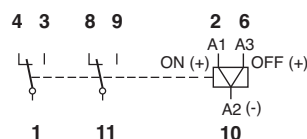

Fig.1 AC voltage endurance

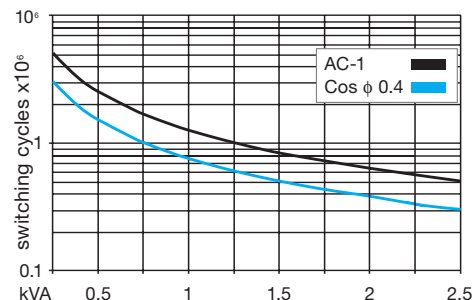
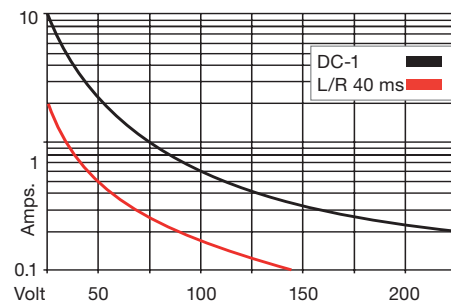
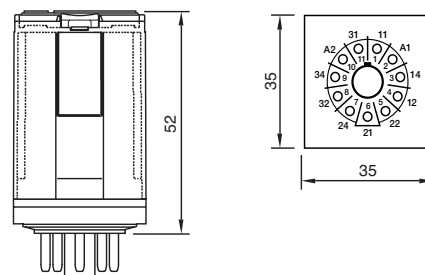

Fig. 2 DC load limit curve



Dimensions



Technical approvals, conformities



IEC/EN 61810; IEC/EN 60947

C3-N3x

3 pole | changeover contact | sensitive coil | plug-in

Maximum contact load	6 A/250 V	AC-1	6 A/30 V	DC-1
Recommended minimum contact load	10 mA/10 V	Code 4		
	5 mA/5 V	Code 8		

Contacts

Material	Standard	Code 4	AgNi + 0.2 μ Au
	Optional	Code 8	AgNi + 10 μ Au
Rated Load	6 A		
Switch-on current max. (20 ms)	15 A		
Switching voltage max.	250 V		
AC load (Fig 1)	1.5 kVA		
DC load	see Fig. 2		

Coil

Coil resistance	see table; tolerance ± 10 %
Pick-up voltage	≤ 0.8 x U _N
Release voltage	≥ 0.1 x U _N
Nominal power	800 mW

Coil table

V AC	Ω	mA	VDC	Ω	mA
24	67	92	24	480	50
48	296	46	48	1K8	26
115	1K7	19	110	9K	12
230	7K1	9.5	220	36K1	6

Insulation

	Volt rms / 1 min
Contact open	1000 V
Contact/contact	2.5 kV
Contact/coil	2.5 kV
Insulation resistance at 500 V	≥1 GΩ
Insulation, IEC 61810-1	2.5 kV

Specifications

Ambient temperature operation/storage	-40...60 °C / -40 ... 80 °C (no ice)
Pick-up time/bounce time	18 ms/≤ 3 ms
Release time/bounce time	10 ms/≤ 1 ms
Mechanical life ops	DC: 20 Mill.
DC voltage endurance at rated load	≥ 100 000 switching cycles
Switching frequency at rated load	≤ 1200/ops/h
Weight	90 g

Product References

VDC 24, 48, 60, 110

Free wheeling diode

Polarity and free wheeling diode

Other voltages on request

C3-N34/DC ... V	C3-N38/DC ... V
C3-N34D/DC ... V	C3-N38D/DC ... V
C3-N34F/DC ... V	C3-N38F/DC ... V

"..." List Coil Voltage to complete Product References

Accessories (See also Section Sockets)

Socket:

S3-B, S3-S, S3-L, S3-PO, S3-MB0, S3-MB1
SO-NP (BAG 10 PCS)

Blanking Plug:

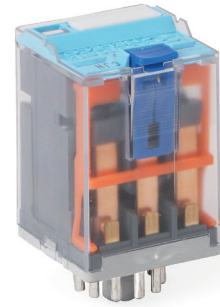

Connection diagram

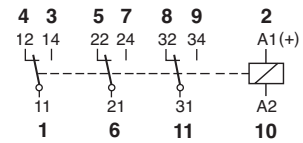

Fig.1 AC voltage endurance

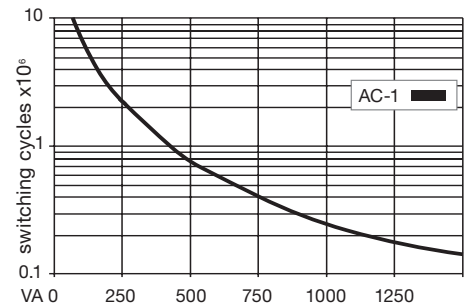
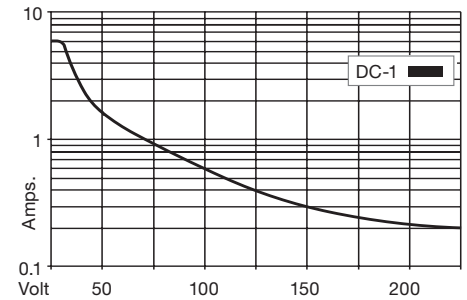
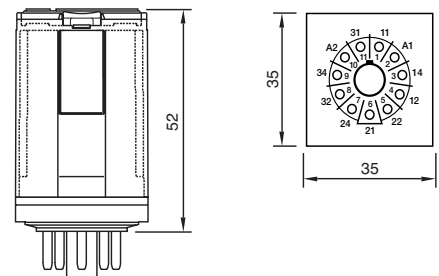

Fig. 2 DC load limit curve



Dimensions



Technical approvals, conformities



C4-A4x

4 pole | changeover contact | plug-in Faston

Maximum contact load	10 A/250 V AC-1	0.5 A/110 V DC-1
	10 A/30 V DC-1	0.2 A/220 V DC-1
Recommended minimum contact load	5 mA/5 V	Code 8

Contacts

Material	Standard	Code 0	⚡ AgNi
	Optional	Code 8	⚡ AgNi + 5 μ Au
Rated Load	10 A		
Switch-on current max. (20 ms)	30 A		
Switching voltage max.	250 V		
AC load (Fig 1)	2.5 kVA		
DC load	see Fig. 2		

Coil

Coil resistance	see table; tolerance ± 10 %
Pick-up voltage	≤ 0.8 x U _n
Release voltage	≥ 0.1 x U _n
Nominal power	2.4 VA (AC)/1.4 W (DC)

Coil table

V AC	Ω	mA	VDC	Ω	mA
24	65	100	24	414	58
48	286	50	48	1K6	30
115	1K7	21	110	8K1	13
-	-	-	120-125	10K	12.3
230	6K8	10	220	35K7	6.2

Insulation

	Volt rms / 1 min
Contact open	1000 V
Contact/contact	2.5 kV
Contact/coil	2.5 kV
Insulation resistance at 500 V	≥ 1 GΩ
Insulation, IEC 61810-1	2.5 kV

Specifications

Ambient temperature operation/storage	-40...60 °C / -40 ... 80 °C (no ice)
Pick-up time/bounce time	20 ms/≤ 3 ms
Release time/bounce time	8 ms/≤ 1 ms
Mechanical life ops	AC: 10 Mill./DC: 20 Mill.
DC voltage endurance at rated load	≥ 100 000 switching cycles
Switching frequency at rated load	≤ 1200/ops/h
Weight	90 g

Product References

V AC 50 Hz/60 Hz: 24, 48, 115, (120), 230, (240)

LED

RC Suppressor

VDC 24, 48, 110, 220

LED

Free wheeling diode

Polarity and free wheeling diode

AC/DC bridge rectifier 24 V, 48 V, 60 V

Other voltages on request

C4-A40/AC ... V
C4-A40X/AC ... V
C4-A40R/AC ... V

C4-A48/AC ... V
C4-A48X/AC ... V
C4-A48R/AC ... V

C4-A40/DC ... V
C4-A40X/DC ... V
C4-A40DX/DC ... V
C4-A40FX/DC ... V

C4-A48/DC ... V
C4-A48X/DC ... V
C4-A48DX/DC ... V
C4-A48FX/DC ... V

C4-A40BX/UC ... V

C4-A48BX/UC ... V

"..." List Coil Voltage to complete Product References

Accessories (See also Section Sockets)

Socket:

Wall Mounting Adapter:

Blanking Plug:

S4-J, S4-L, S4-P

S5-R (BAG 5 PCS)

SO-NP (BAG 10 PCS)

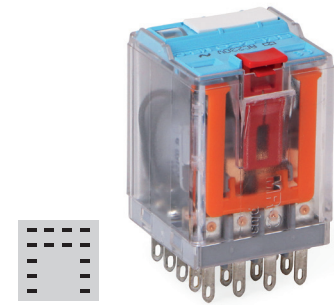

Connection diagram

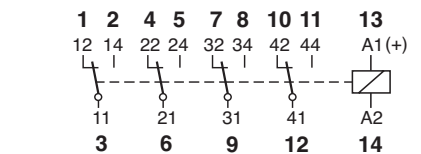

Fig.1 AC voltage endurance

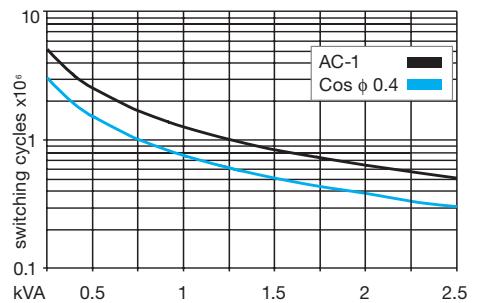
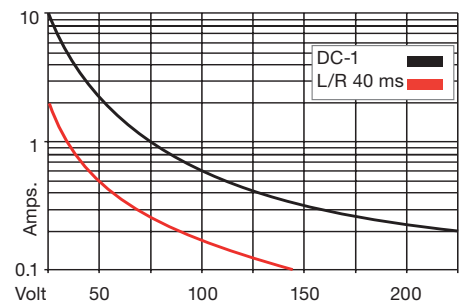
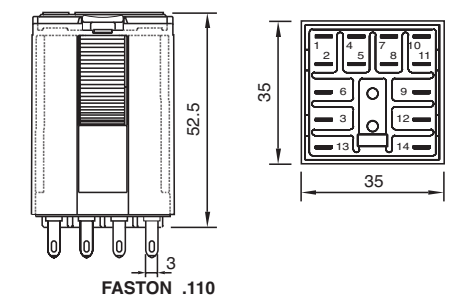

Fig. 2 DC load limit curve



Dimensions



Technical approvals, conformities



C4-X2x

2 pole | normally open serial contact | plug-in Faston

Maximum contact load	10 A/250 V AC-1	7 A/110 V DC-1
	10 A/30 V DC-1	1.2 A/220 V DC-1

Contacts

Material	Standard	Code 0	⚡ AgNi
Rated Load			10 A
Switch-on current max. (20 ms)			30 A
Switching voltage max			250 V
AC load (Fig 1)			2.5 kVA
DC load			see Fig. 2

Coil

Coil resistance	see table; tolerance ± 10 %
Pick-up voltage	≤ 0.8 x U _N
Release voltage	≥ 0.1 x U _N
Nominal power	2.4 VA (AC)/1.3 W (DC)

Coil table

V AC	Ω	mA	VDC	Ω	mA
24	65	100	24	443	54
48	286	50	48	1K8	27
115	1K7	21	110	9K2	12
230	6k8	10	220	30K3	6

Insulation

	Volt rms / 1 min
Contact open	2500 V
Contact/contact	2.5 kV
Contact/coil	2.5 kV
Insulation resistance at 500 V	≥ 1 G.Ω
Insulation, IEC 61810-1	2.5 kV

Specifications

Ambient temperature operation/storage	-40...60 °C / -40 ... 80 °C (no ice)
Pick-up time/bounce time	20 ms/≤ 3 ms
Release time/bounce time	8 ms/≤ 1 ms
Mechanical life ops	AC: 10 Mill./DC: 20 Mill.
DC voltage endurance at rated load	≥ 100 000 switching cycles
Switching frequency at rated load	≤ 1200/ops/h
Weight	90 g

Product References

V AC 50 Hz/60 Hz: 24, 48, 115, (120), 230, (240)	C4-X20/AC ... V
LED	C4-X20X/AC ... V
RC Suppressor	C4-X20R/AC ... V
VDC 24, 48, 110, 220	C4-X20/DC ... V
LED	C4-X20X/DC ... V
Free wheeling diode	C4-X20DX/DC ... V
Polarity and free wheeling diode	C4-X20FX/DC ... V
AC/DC bridge rectifier 24 V, 48 V, 60 V	C4-X20BX/UC ... V

Other voltages on request

"..." List Coil Voltage to complete Product References

Accessories (See also Section Sockets)

Socket:	S4-J, S4-L, S4-P
Wall Mounting Adapter:	S5-R (BAG 5 PCS)
Blanking Plug:	SO-NP (BAG 10 PCS)

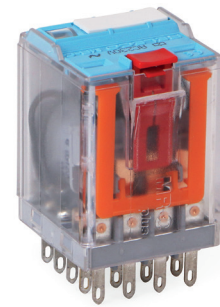

Connection diagram

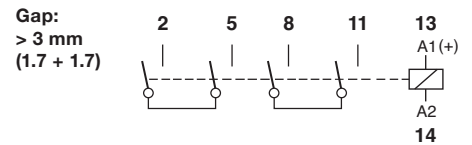

Fig.1 AC voltage endurance

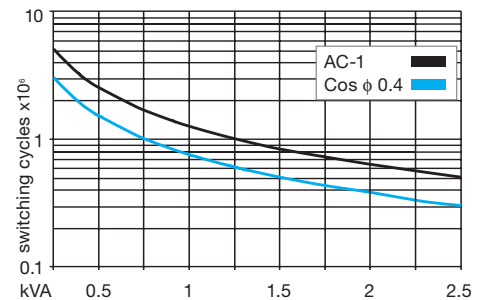
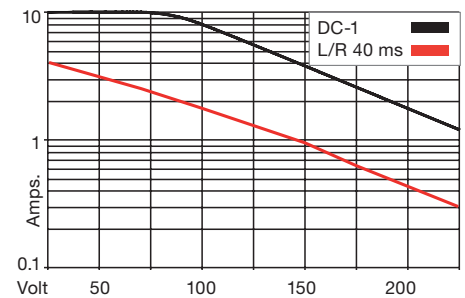
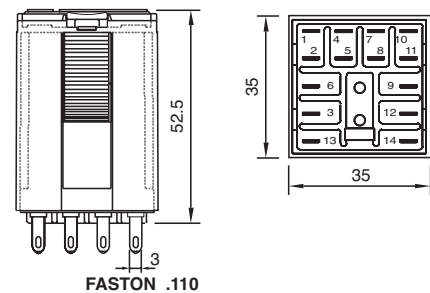

Fig. 2 DC load limit curve



Dimensions



Technical approvals, conformities



IEC/EN 61810; IEC/EN 60947

C4-R3x

3 pole | changeover contact | retentive | plug-in

Maximum contact load	10 A/250 V AC-1	0.5 A/110 V DC-1
	10 A/10 V DC-1	0.2 A/220 V DC-1
Recommended minimum contact load	5 mA/5 V Code 8	

Contacts

Material	Standard	Code 0	⚡ AgNi
	Optional	Code 8	⚡ AgNi + 5 μ Au
Rated Load	10 A		
Switch-on current max. (20 ms)	30 A		
Switching voltage max.	250 V		
AC load	2.5 kVA		
DC load	see Fig. 2		

Coil

Coil resistance	see table; tolerance ± 10 %
ON pulse power	1.5 VA/W
OFF pulse power	0.5 VA/W
Pull-in ON/OFF	1 Winding for AC, 2 Windings for DC ≤ 0.8 x U _N

Internal Diagram:

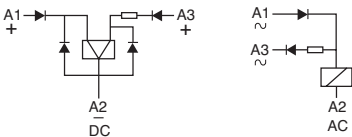

Coil table

V AC	mA ON	mA OFF	VDC	mA ON	mA OFF
24	75	12	12	125	41
48	38	6	24	63	21
115	16	2.5	48	31	10
230	8	1.3	110	14	4.5

Insulation

Insulation	Volt rms / 1 min
Contact open	1000 V
Contact/contact	2.5 kV
Contact/coil	2.5 kV
Insulation resistance at 500 V	≥ 1 G.Ω
Insulation, IEC 61810-1	2.5 kV

Specifications

Ambient temperature operation/storage	-40...60 °C / -40 ... 80 °C (no ice)
Minimum pulse length for ON/OFF	50 ms
Mechanical life ops	AC: 10 Mill./DC: 20 Mill. switching cycles
DC voltage endurance at rated load	≥ 100 000 switching cycles
Switching frequency at rated load	≤ 1200/h
Weight	95 g

Product References

V AC 50 Hz/60 Hz: 24, 48, 115, 230

C4-R30/AC ... V C4-R38/AC ... V
C4-R30/DC ... V C4-R38/DC ... V

VDC 12, 24, 48, 110

Other voltages on request

"..." List Coil Voltage to complete Product References

Accessories (See also Section Sockets)

Socket:	S4-J, S4-L, S4-P
Wall Mounting Adapter:	S5-R (BAG 5 PCS)
Blanking Plug:	SO-NP (BAG 10 PCS)

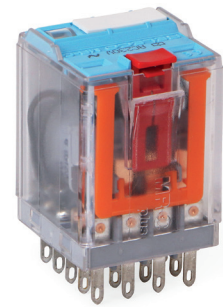

Connection diagram

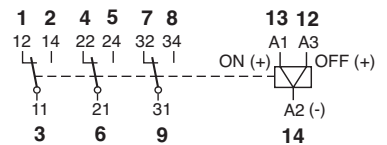

Fig.1 AC voltage endurance

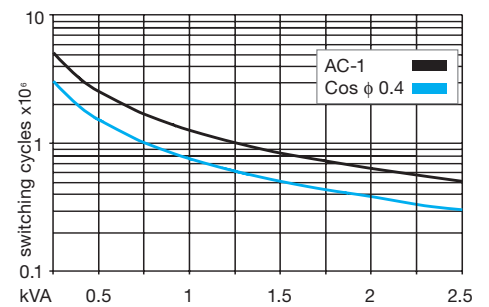
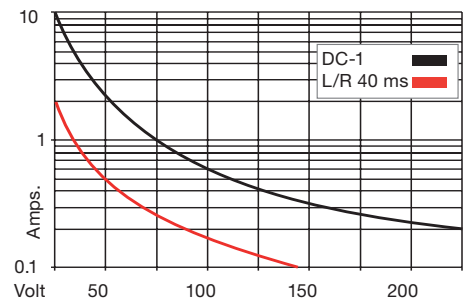
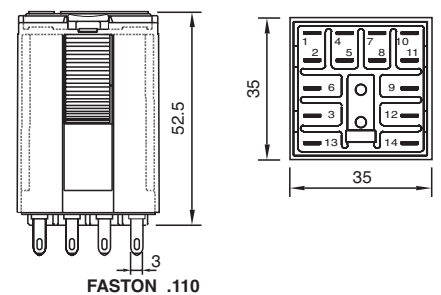

Fig. 2 DC load limit curve



Dimensions



Technical approvals, conformities



IEC/EN 61810; IEC/EN 60947

C5-A2x

2 pole | changeover contact | plug-in Faston



Maximum contact load	16 A/400 V AC-1	0.5 A/110 V DC-1
	16 A/30 V DC-1	0.2 A/220 V DC-1

Contacts

Material	Standard	Code 0	⚡ AgNi
Rated Load			16 A
Switch-on current max. (20 ms)			40 A
Switching voltage max.			400 V
AC load (Fig 1)			4 kVA
DC load			see Fig. 2

Coil

Coil resistance	see table; tolerance ± 10 %
Pick-up voltage	≤ 0.8 × U _N
Release voltage	≥ 0.1 × U _N
Nominal power	2.4 VA (AC)/1.4 W (DC)

Coil table

V AC	Ω	mA	VDC	Ω	mA
24	65	100	24	414	58
48	286	50	48	1K6	30
115	1K7	21	110	8K1	13
230	6K8	10	220	30K3	6
400	18K8	6			

Insulation

	Volt rms / 1 min
Contact open	1000 V
Contact/contact	4 kV
Contact/coil	4 kV
Insulation resistance at 500 V	≥3 GΩ
Insulation, IEC 61810-1	4 kV

Specifications

Ambient temperature operation/storage	-40...60 °C /-40 ... 80 °C (no ice)
Pick-up time/bounce time	20 ms/≤ 3 ms
Release time/bounce time	10 ms/≤ 1 ms
Mechanical life ops	AC: 10 Mill./DC: 20 Mill.
DC voltage endurance at rated load	≥100 000 switching cycles
Switching frequency at rated load	≤ 1200/ops/h
Weight	90 g

Product References

V AC 50 Hz/60 Hz: 24, 48, 115 (120), 230 (240)

LED

RC Suppressor (max 250 V)

C5-A20/AC ... V
C5-A20X/AC ... V
C5-A20R/AC ... V

VDC 24, 48, 110, 220

LED

Free wheeling diode

Polarity and free wheeling diode

C5-A20/DC ... V
C5-A20X/DC ... V
C5-A20DX/DC ... V
C5-A20FX/DC ... V

AC/DC bridge rectifier 24 V, 48 V, 60 V

Other voltages on request

C5-A20BX/UC ... V

"..." List Coil Voltage to complete Product References

Accessories (See also Section Sockets)

Socket:	S5-M, S5-P
Wall Mounting Adapter:	S5-R (BAG 5 PCS)
Blanking Plug:	SO-NP (BAG 10 PCS)

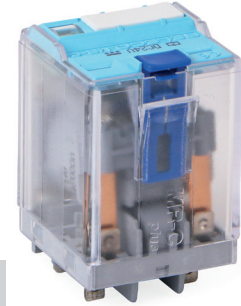

Connection diagram

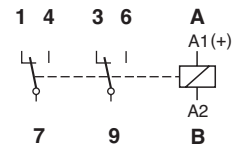

Fig.1 AC voltage endurance

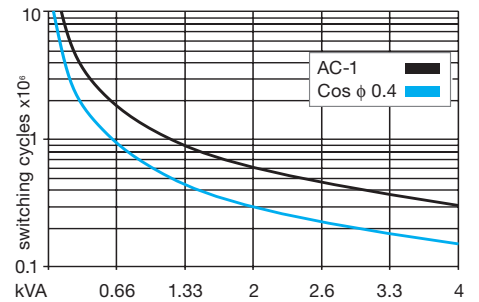
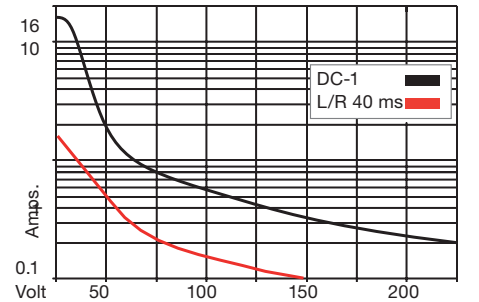
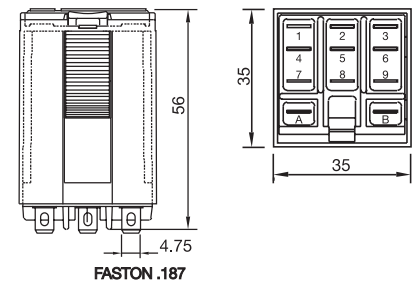

Fig. 2 DC load limit curve



Dimensions



Technical approvals, conformities



IEC/EN 61810; IEC/EN 60947

C5-A3x

3 pole | changeover contact | plug-in Faston

Maximum contact load	16 A/400 V AC-1	0.5 A/110 V DC-1
	16 A/30 V DC-1	0.2 A/220 V DC-1

Contacts

Material	Standard	Code 0	⚡ AgNi
	Optional	Code 5	⚡ AgSnO ₂
Rated Load	16 A		
Switch-on current max. (20 ms)	40 A		
Switching voltage max.	400 V		
AC load (Fig 1)	4 kVA		
DC load	see Fig. 2		

Coil

Coil resistance	see table; tolerance ± 10 %
Pick-up voltage	≤ 0.8 x U _N
Release voltage	≥ 0.1 x U _N
Nominal power	2.4 VA (AC)/1.4 W (DC)

Coil table

V AC	Ω	mA	VDC	Ω	mA
24	65	100	24	414	58
48	286	50	48	1K6	30
115	1K7	21	110	8K1	13
230	6K8	10	220	30K3	6.2
400	18K8	6			

Insulation

	Volt rms / 1 min
Contact open	1000 V
Contact/contact	4 kV
Contact/coil	4 kV
Insulation resistance at 500 V	≥3 G.Ω
Insulation, IEC 61810-1	4 kV

Specifications

Ambient temperature operation/storage	-40...60 °C / -40 ... 80 °C (no ice)
Pick-up time/bounce time	20 ms/≤ 3 ms
Release time/bounce time	10 ms/≤ 1 ms
Mechanical life ops	AC: 10 Mill./DC: 20 Mill.
DC voltage endurance at rated load	≥100 000 switching cycles
Switching frequency at rated load	≤ 1200/h
Weight	95 g

Product References

V AC 50 Hz/60 Hz: 24, 48, 115, (120), 230, (240)

LED

RC Suppressor (max 250 V)

VDC 24, 48, 110, 220

LED

Free wheeling diode

Polarity and free wheeling diode

AC/DC bridge rectifier 24 V, 48 V, 60 V

Other voltages on request

C5-A30/AC ... V
C5-A30X/AC ... V
C5-A30R/AC ... V

C5-A30/DC ... V
C5-A30X/DC ... V
C5-A30DX/DC ... V
C5-A30FX/DC ... V

C5-A30BX/UC ... V

C5-A35/AC ... V
C5-A35X/AC ... V
C5-A35R/AC ... V

C5-A35/DC ... V
C5-A35X/DC ... V
C5-A35DX/DC ... V
C5-A35FX/DC ... V

C5-A35BX/UC ... V

"..." List Coil Voltage to complete Product References

Accessories (See also Section Sockets)

Socket:	S5-M, S5-P
Wall Mounting Adapter:	S5-R (BAG 5 PCS)
Blanking Plug:	SO-NP (BAG 10 PCS)

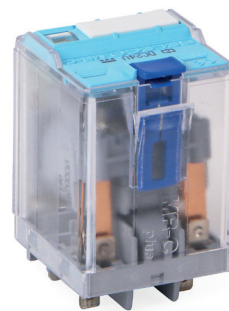

Connection diagram

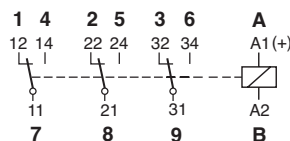

Fig.1 AC voltage endurance

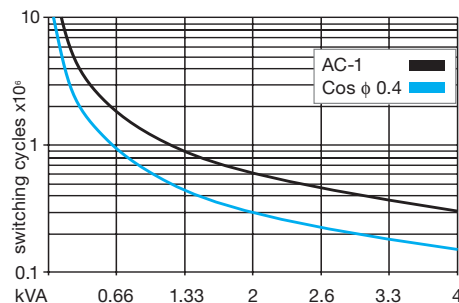
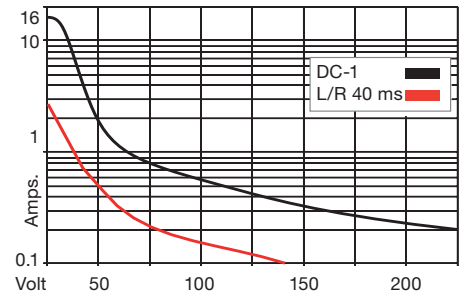
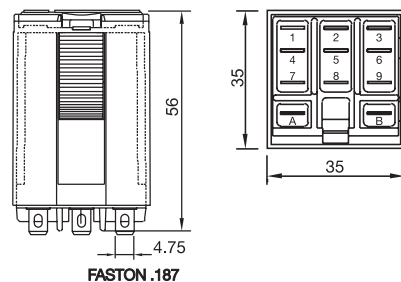

Fig. 2 DC load limit curve



Dimensions



Technical approvals, conformities



IEC/EN 61810; IEC/EN 60947

C5-G3x

3 pole | normally open contact | plug-in Faston

Maximum contact load	16 A/400 V AC-1	1.2 A/110 V DC-1
	16 A/30 V DC-1	0.4 A/220 V DC-1

Contacts

Material	Standard	Code 0	⚡ AgNi
	Optional	Code 5	⚡ AgSnO ₂
Rated Load	16 A		
Switch-on current max. (20 ms)	40 A		
Switching voltage max.	400 V		
AC load (Fig 1)	4 kVA		
DC load	see Fig. 2		

Coil

Coil resistance	see table; tolerance ± 10 %
Pick-up voltage	≤ 0.8 x U _N
Release voltage	≥ 0.1 x U _N
Nominal power	2.4 VA (AC)/1.6 W (DC)

Coil table

V AC	Ω	mA	VDC	Ω	mA
24	65	100	12	90	133
48	286	50	24	373	66
115	1K7	21	48	1K4	34
230	6K8	10	110	7K6	15
400	18K8	6	220	30K3	7.5

Insulation

	Volt rms / 1 min
Contact open	2000 V
Contact/contact	4 kV
Contact/coil	4 kV
Insulation resistance at 500 V	≥ 3 G.Ω
Insulation, IEC 61810-1	4 kV

Specifications

Ambient temperature operation/storage	-40...60 °C / -40 ... 80 °C (no ice)
Pick-up time/bounce time	20 ms/≤ 3 ms
Release time/bounce time	10 ms/≤ 1 ms
Mechanical life ops	AC: 10 Mill./DC: 20 Mill.
DC voltage endurance at rated load	≥100 000 switching cycles
Switching frequency at rated load	≤ 1200/h
Weight	95 g

Product References

V AC 50 Hz/60 Hz: 24, 48, 115, (120), 230, (240)

LED

RC Suppressor (max 250 V)

C5-G30/AC ... V
C5-G30X/AC ... V
C5-G30R/AC ... V

C5-G35/AC ... V
C5-G35X/AC ... V
C5-G35R/AC ... V

VDC 12, 24, 48, 110, 220

LED

Free wheeling diode

Polarity and free wheeling diode

C5-G30/DC ... V
C5-G30X/DC ... V
C5-G30DX/DC ... V
C5-G30FX/DC ... V

C5-G35/DC ... V
C5-G35X/DC ... V
C5-G35DX/DC ... V
C5-G35FX/DC ... V

AC/DC bridge rectifier 24 V, 48 V, 60 V

Other voltages on request

C5-G30BX/UC ... V

C5-G35BX/UC ... V

"..." List Coil Voltage to complete Product References

Accessories (See also Section Sockets)

Socket:

Wall Mounting Adapter:

Blanking Plug:

S5-M, S5-P

S5-R (BAG 5 PCS)

SO-NP (BAG 10 PCS)

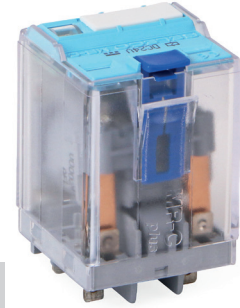

Connection diagram

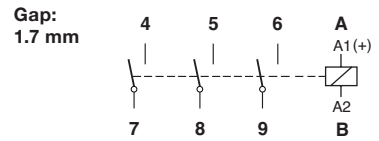

Fig.1 AC voltage endurance

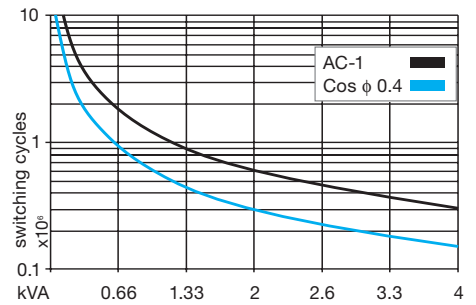
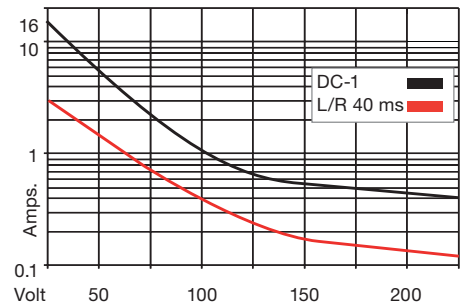
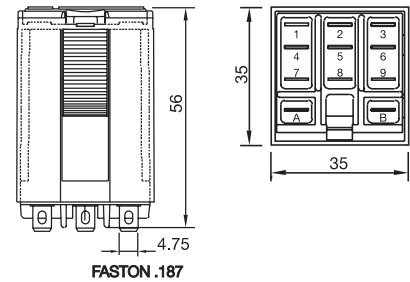

Fig. 2 DC load limit curve



Dimensions



Technical approvals, conformities



IEC/EN 61810; IEC/EN 60947

C5-X1x

1 pole | normally open serial contact | plug-in Faston

Maximum contact load	16 A/400 V AC-1	7 A/110 V DC-1
	16 A/30 V DC-1	1.2 A/220V DC-13

Contacts

Material	Standard	Code 0	⚡ AgNi
Rated Load			16 A
Switch-on current max. (20 ms)			40 A
Switching voltage max.			400 V
AC load (Fig 1)			4 kVA
DC load			see Fig. 2

Coil

Coil resistance	see table; tolerance ± 10 %
Pick-up voltage	≤ 0.8 x U _N
Release voltage	≥ 0.1 x U _N
Nominal power	2.4 VA (AC)/1.3 W (DC)

Coil table

V AC	Ω	mA	VDC	Ω	mA
24	65	100	12	110	108
48	286	50	24	443	54
115	1K7	21	48	1K7	27
230	6K8	10	110	9K2	12
400	18K8	6	220	30K3	6.2

Insulation

	Volt rms / 1 min
Contact open	4 kV
Contact/contact	4 kV
Contact/coil	4 kV
Insulation resistance at 500 V	≥ 3 GΩ
Insulation, IEC 61810-1	4 kV

Specifications

Ambient temperature operation/storage	-40...60 °C / -40 ... 80 °C (no ice)
Pick-up time/bounce time	20 ms/≤ 3 ms
Release time/bounce time	10 ms/≤ 1 ms
Mechanical life ops	AC: 10 Mill./DC: 20 Mill.
DC voltage endurance at rated load	≥100 000 switching cycles
Switching frequency at rated load	≤ 1200/h
Weight	90 g

Product References

V AC 50 Hz/60 Hz: 24, 48, 115 (120), 230 (240)

LED

RC Suppressor (max 250 V)

VDC 12, 24, 48, 110, 220

LED

Free wheeling diode

Polarity and free wheeling diode

AC/DC bridge rectifier 24 V, 48 V, 60 V

Other voltages on request

"..." List Coil Voltage to complete Product References

Accessories (See also Section Sockets)

Socket:	S5-M, S5-P
Wall Mounting Adapter:	S5-R (BAG 5 PCS)
Blanking Plug:	SO-NP (BAG 10 PCS)



Connection diagram

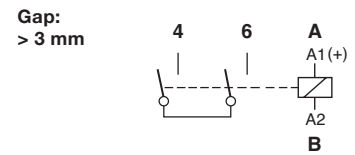

Fig.1 AC voltage endurance

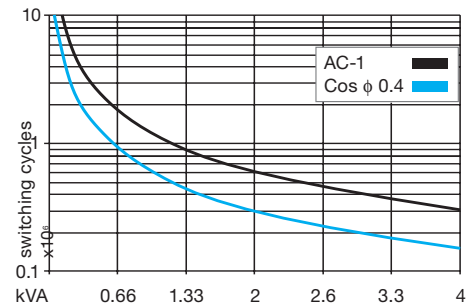
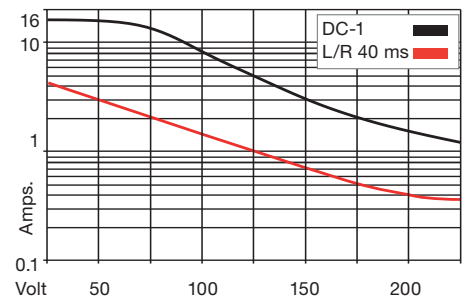
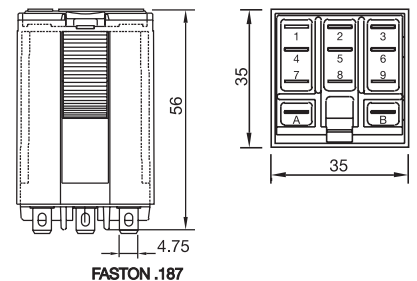

Fig. 2 DC load limit curve



Dimensions



Technical approvals, conformities



IEC/EN 61810; IEC/EN 60947

C5-M1x

1 pole | normally open serial contact with blow magnet | plug-in Faston



Maximum contact load	16 A/400 V AC-1	10 A/220 V DC-1
	3.6 A/110 V DC-13	2 A/220 V DC-13

Contacts

Material	Standard	Code 0	⚡ AgNi
Rated Load			16 A
Switch-on current max. (20 ms)			40 A
Switching voltage max.			400 V
AC load (Fig 1)			4 kVA
DC load			see Fig. 2

Coil

Coil resistance	see table; tolerance ± 10 %
Pick-up voltage	≤ 0.8 × U _N
Release voltage	≥ 0.1 × U _N
Nominal power	2.4 VA (AC)/1.3 W (DC)

Coil table

V AC	Ω	mA	VDC	Ω	mA
24	65	100	12	110	108
48	286	50	24	443	54
115	1K7	21	48	1K7	27
230	6K8	10	110	9K2	12
400	18K8	6	220	30K3	6.2

Insulation

	Volt rms / 1 min
Contact open	4000 V
Contact/contact	4 kV
Contact/coil	4 kV
Insulation resistance at 500 V	≥ 3 GΩ
Insulation, IEC 61810-1	4 kV

Specifications

Ambient temperature operation/storage	-40...60 °C / -40 ... 80 °C (no ice)
Pick-up time/bounce time	20 ms/≤ 3 ms
Release time/bounce time	10 ms/≤ 1 ms
Mechanical life ops	AC: 10 Mill./DC: 20 Mill.
DC voltage endurance	see fig. 2
Switching frequency at rated load	≤ 1200/h
Weight	90 g

Product References

V AC 50 Hz/60 Hz: 24, 48, 115 (120), 230 (240)

LED

RC Suppressor (max 250 V)

C5-M10/AC ... V
C5-M10X/AC ... V
C5-M10R/AC ... V

VDC 12, 24, 48, 110, 220

LED

Free wheeling diode

Polarity and free wheeling diode

C5-M10/DC ... V
C5-M10X/DC ... V
C5-M10DX/DC ... V
C5-M10FX/DC ... V

AC/DC bridge rectifier 24 V, 48 V, 60 V

Other voltages on request

C5-M10BX/UC ... V

"..." List Coil Voltage to complete Product References

Accessories (See also Section Sockets)

Socket:	S5-M, S5-P
Wall Mounting Adapter:	S5-R (BAG 5 PCS)
Blanking Plug:	SO-NP (BAG 10 PCS)

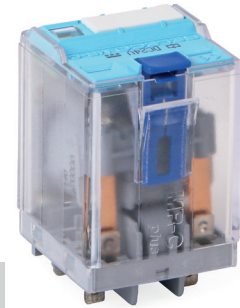

Connection diagram

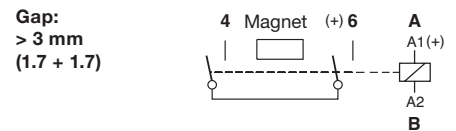

Fig.1 AC voltage endurance

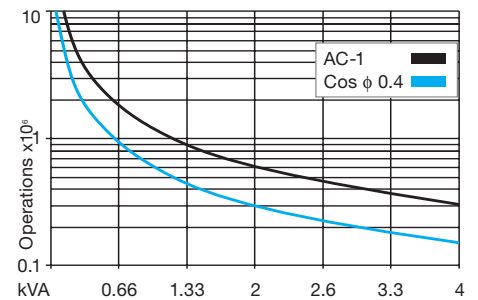
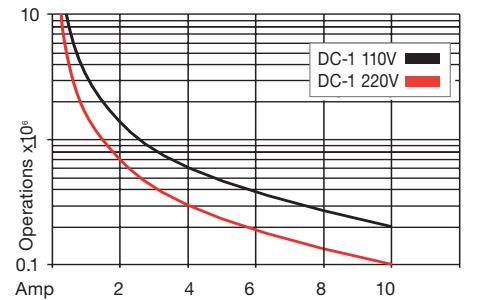
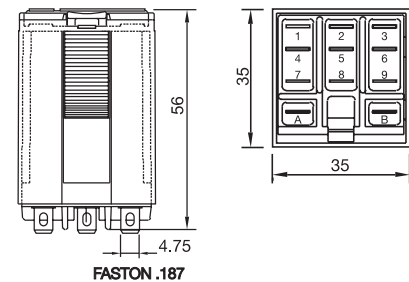

Fig. 2 DC voltage endurance



Dimensions



Technical approvals, conformities



IEC/EN 61810; IEC/EN 60947

C5-M2x

2 pole | normally open contact with blow magnet | plug-in Faston

Maximum contact load	16 A / 250 V AC-1	7 A / 110 V DC-1
		3 A / 220 V DC-1

Contacts

Material	Standard	Code 0	⚡ AgNi
Rated Load			16 A
Switch-on current max. (20 ms)			40 A
Switching voltage max.			250 V
AC load (Fig 1)			4 kVA
DC load			see Fig. 2

Coil

Coil resistance	see table; tolerance ± 10 %
Pick-up voltage	≥ 0.8 x U _N
Release voltage	≥ 0.1 x U _N
Nominal power	2.4 VA (AC) / 1.6 W (DC)

Coil table

V AC	Ω	mA	VDC	Ω	mA
24	65	100	12	90	133
48	286	50	24	373	66
115	1K7	21	48	1K4	33
230	6K8	10.4	110	7K6	15

Insulation

Contact open	Volt rms / 1 min
Contact/contact	2 kV
Contact/coil	4 kV
Insulation resistance at 500 V	3 kV
Insulation, EN 60947/IEC 61810-1:	≥ 3 GΩ
	4 kV

Specifications

Ambient temperature operation/storage	-40...60 °C / -40 ... 80 °C (no ice)
Pick-up time/bounce time	20 ms/≤ 3 ms
Release time/bounce time	10 ms/≤ 1 ms
Mechanical life ops	AC: 10 Mill./DC: 20 Mill. switching cycles
DC Rated load	≥ 75 000 switching cycles
Switching frequency at rated load	≤ 1200/h
Weight	90 g

Product References

V AC 50 Hz/60 Hz: 24, 48, 115 (120), 230 (240)

LED

RC Suppressor

VDC 12, 24, 48, 110, 220

LED

Free wheeling diode

Polarity and free wheeling diode

AC/DC bridge rectifier 24 V, 48 V, 60 V

Other voltages on request

C5-M20/AC ... V
C5-M20X/AC ... V
C5-M20R/AC ... V

C5-M20/DC ... V
C5-M20X/DC ... V
C5-M20DX/DC ... V
C5-M20FX/DC ... V

C5-M20BX/UC ... V

"..." List Coil Voltage to complete Product References

Accessories (See also Section Sockets)

Socket:	S5-M, S5-P
Wall Mounting Adapter:	S5-R (BAG 5 PCS)
Blanking Plug:	SO-NP (BAG 10 PCS)

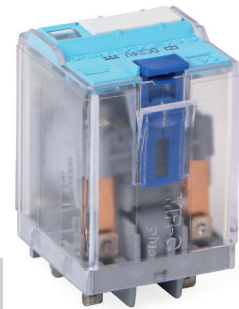

Connection diagram

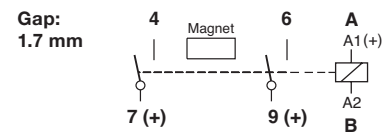

Fig.1 AC voltage endurance

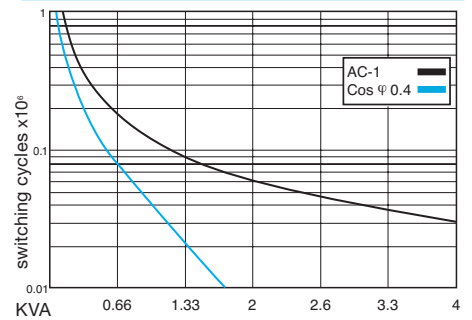
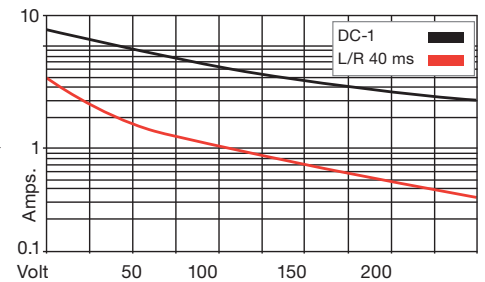
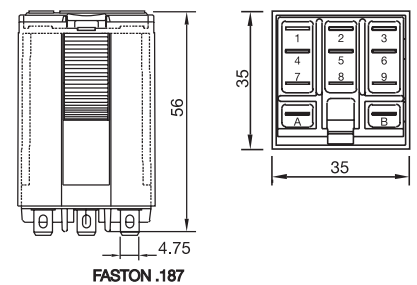

Fig. 2 DC load limit curve



Dimensions



Technical approvals, conformities



IEC/EN 61810; IEC/EN 60947

C5-R2x

2 pole | changeover contact | retentive | plug-in

Maximum contact load	10 A/400 V AC-1	10 A/30 V DC-1
	0.2 A/250 V DC-1	0.5 A/110 V DC-1

Contacts

Material	Standard	Code 0	⚡ AgNi
Rated Load			10 A
Switch-on current max. (20 ms)			30 A
Switching voltage max.			400 V
AC load (Fig 1)			4 kVA
DC load			see Fig. 2

Coil

Coil resistance	see table; tolerance ± 10 %
ON pulse power	1.5 VA/W
OFF pulse power	0.5 VA/W
1 winding for AC, 2 winding for DC	
Pull-in ON/OFF	< 0.8 x U _n

Internal Diagram:

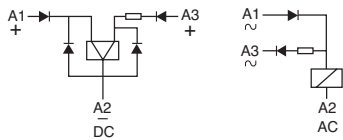

Coil table

V AC	mA ON	mA OFF	VDC	mA ON	mA OFF
24	75	12	12	125	41
48	38	6	24	63	21
115	16	2.5	48	31	10
230	8	1.3	110	14	4.5

Insulation

Contact open	Volt rms / 1 min	1000 V
Contact/contact		4 kV
Contact/coil		4 kV
Insulation resistance at 500 V		≥3 GΩ
Insulation, EN 60947/IEC 61810-1		4 kV

Specifications

Ambient temperature operation/storage	-40...60 °C / -40 ... 80 °C (no ice)
Minimum pulse ON/OFF	50 ms
Mechanical life ops	AC: 10 Mill./DC: 20 Mill.
DC voltage endurance at rated load	≥100 000 switching cycles
Switching frequency at rated load	≤ 1200/h
Weight	95 g

Product References

V AC 50 Hz/60 Hz: 24, 48, 115, 230

C5-R20/AC ... V

VDC : 12, 24, 48, 110,

C5-R20/DC ... V

Other voltages on request

"..." List Coil Voltage to complete Product References

Accessories (See also Section Sockets)

Socket:	S5-M, S5-P
Wall Mounting Adapter:	S5-R (BAG 5 PCS)
Blanking Plug:	SO-NP (BAG 10 PCS)



Connection diagram

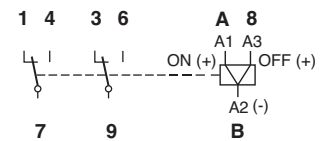

Fig.1 AC voltage endurance

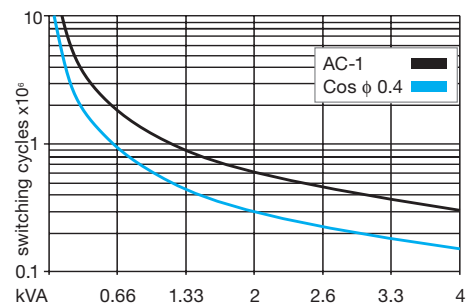
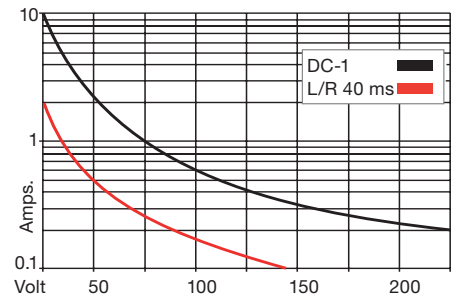
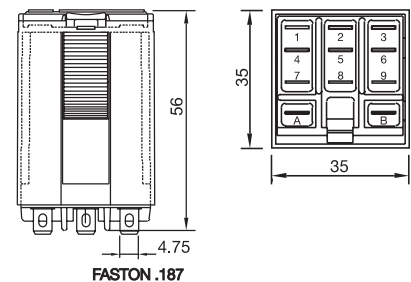

Fig. 2 DC load limit curve



Dimensions



Technical approvals, conformities



IEC/EN 61810; IEC/EN 60947

C7-A1x

1 pole | changeover contact | plug-in Faston

Maximum contact load	16 A/250 V AC-1	0.5 A/110 V DC-1
	16 A/24 V DC-1	0.2 A/220 V DC-1

Contacts

Material	Standard	Code 0	⚡ AgNi
Rated Load			16 A
Switch-on current max. (20 ms)			40 A (120 A for code 5)
Switching voltage max.			250 V
AC load (Fig 1)			4 kVA
DC load			see Fig. 2
Relay compatible with socket S7-C			

Coil

Coil resistance	see table; tolerance ± 10 %
Pick-up voltage	≤ 0.8 x U _N
Release voltage	≥ 0.1 x U _N
Nominal power	1.2 VA (AC)/1.3 W (DC)

Coil table

V AC	Ω	mA	VDC	Ω	mA
24	174	50	12	111	108
48	686	25	24	432	55
115	4K3	10.4	48	1K7	28
230	18K6	5.2	110	9K2	12

Insulation

Insulation	Volt rms / 1 min
Contact open	1000 V
Contact/coil	2.5 kV
Insulation resistance at 500 V	≥ 1 GΩ
Insulation, IEC 61810-1	2.5 kV

Specifications

Ambient temperature operation/storage	-40...60 °C / -40 ... 80 °C (no ice)
Pick-up time/bounce time	16 ms/≤ 3 ms
Release time/bounce time	8 ms/≤ 1 ms
Mechanical life ops	AC: 10 Mill./DC: 20 Mill.
AC/DC voltage endurance at rated load	≥ 100 000 switching cycles
Switching frequency at rated load	≤ 1200/h
Weight	43 g

Product References

V AC 50 Hz/60 Hz: 24, 48, 115 (120), 230 (240) LED

C7-A10/AC ... V
C7-A10X/AC ... V

VDC 12, 24, 48, 110

LED

Free wheeling diode (only 24 DC)

Polarity and free wheeling diode

C7-A10/DC ... V
C7-A10X/DC ... V
C7-A10DX/DC 24 V
C7-A10FX/DC ... V

Other voltages on request

"..." List Coil Voltage to complete Product References

Accessories (See also Section Sockets)

Socket:	S7-C, S7-IO, S7-P
Push only:	S9-OP (BAG 10 PCS)
Blanking Plug:	S9-NP (BAG 10 PCS)



Connection diagram

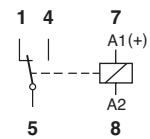

Fig.1 AC voltage endurance

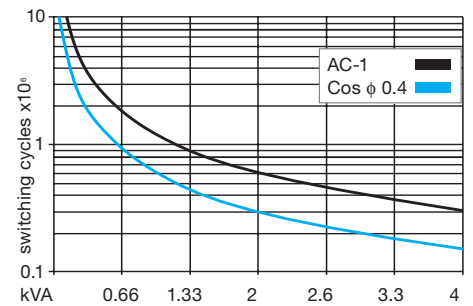
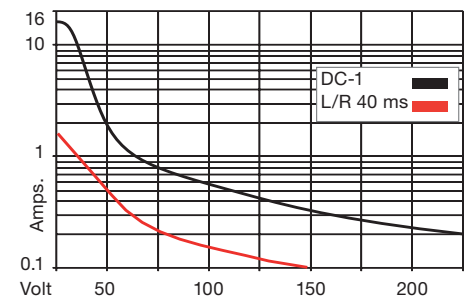
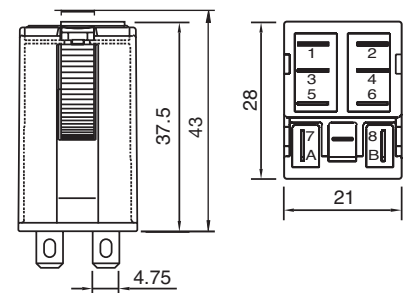

Fig. 2 DC load limit curve



Dimensions



Technical approvals, conformities



IEC/EN 61810; IEC/EN 60947

C7-A2x

2 pole | changeover contact | plug-in Faston

Maximum contact load	10 A/250 V	AC-1	0.5 A/110 V	DC-1
	10 A/30 V	DC-1	0.2 A/220 V	DC-1
Recommended minimum contact load	10 mA/10 V	Code 0		
	5 mA/5 V	Code 8		

Contacts

Material	Standard	Code 0	AgNi
	Optional	Code 8	AgNi + 5 μ Au
Rated Load			10 A
Switch-on current max. (20 ms)			30 A
Switching voltage max.			250 V
AC load (Fig 1)			2.5 kVA
DC load			see Fig. 2

Coil

Coil resistance	see table; tolerance ± 10 %
Pick-up voltage	≤ 0.8 × U _N
Release voltage	≥ 0.1 × U _N
Nominal power	1.2 VA (AC)/1 W (DC)

Coil table

V AC	Ω	mA	VDC	Ω	mA
24	174	50	12	148	85
48	686	25	24	594	43
115	4K3	10.4	48	2K3	21
230	18K6	5.2	110	11K4	10

Insulation

	Volt rms / 1 min
Contact open	1000 V
Contact/contact	2.5 kV
Contact/coil	2.5 kV
Insulation resistance at 500 V	≥ 1 GΩ
Insulation, IEC 61810-1	2.5 kV

Specifications

Ambient temperature operation/storage	-40...60 °C / -40 ... 80 °C (no ice)
Pick-up time/bounce time	16 ms/≤ 3 ms
Release time/bounce time	8 ms/≤ 1 ms
Mechanical life ops	AC: 10 Mill./DC: 20 Mill.
DC voltage endurance at rated load	≥ 100 000 switching cycles
Switching frequency at rated load	≤ 1200/h
Weight	43 g

Product References

V AC 50 Hz/60 Hz: 24, 48, 115 (120), 230 (240)
LED

C7-A20/AC ... V	C7-A28/AC ... V
C7-A20X/AC ... V	C7-A28X/AC ... V

VDC 12, 24, 48, 110

LED

Free wheeling diode (only 24 DC)

Polarity and free wheeling diode

C7-A20/DC ... V	C7-A28/DC ... V
C7-A20X/DC ... V	C7-A28X/DC ... V
C7-A20DX/DC 24 V	C7-A28DX/DC 24 V
C7-A20FX/DC ... V	C7-A28FX/DC ... V

AC/DC bridge rectifier 24 V, 48 V, 60 V

Other voltages on request

C7-A20BX/UC ... V	C7-A28BX/UC ... V
-------------------	-------------------

"..." List Coil Voltage to complete Product References

Accessories (See also Section Sockets)

Socket:	S7-C, S7-IO, S7-P,
Push only:	S9-OP (BAG 10 PCS)
Blanking Plug:	S9-NP (BAG 10 PCS)

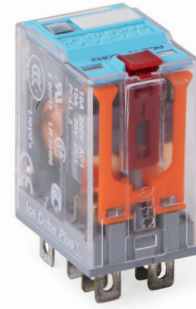

Connection diagram

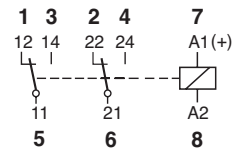

Fig.1 AC voltage endurance

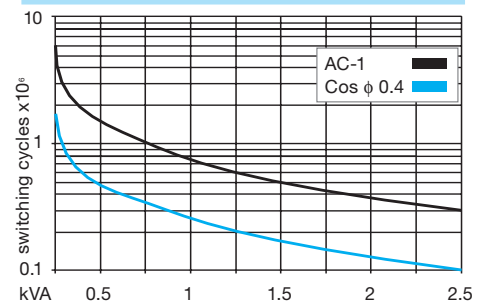
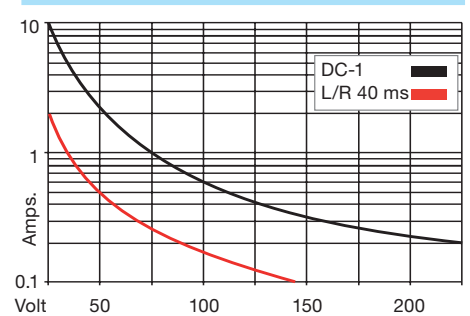
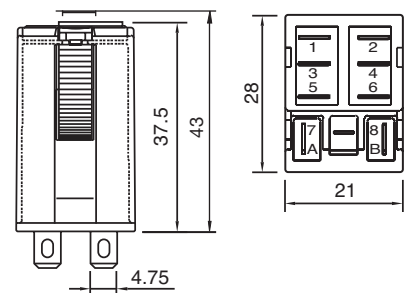

Fig. 2 DC load limit curve



Dimensions



Technical approvals, conformities



C7-T2x

2 pole | changeover twin contact | plug-in

Maximum contact load	6 A/250 V	AC-1	6 A/30 V	DC-1
Recommended minimum contact load	5 mA/5 V	Code 1		
	1 mA/5 V	Code 2		

Contacts

Material	Standard	Code 1	AgNi + 0.2 µ Au
	Optional	Code 2	AgNi + 5 µ Au
Rated Load			6 A
Switch-on current max. (20 ms)			15 A
Switching voltage max.			250 V
AC load (Fig 1)			1.2 kVA
DC load			see fig. 2

Coil

Coil resistance	see table; tolerance ± 10 %
Pick-up voltage	≤ 0.8 x U _n
Release voltage	≥ 0.1 x U _n
Nominal power	1.2 VA (AC)/1 W (DC)

Coil table

V AC	Ω	mA	VDC	Ω	mA
24	174	50	12	148	85
48	686	25	24	594	43
115	4K3	10.4	48	2K3	21
230	18K6	5.2	110	11K4	10

Insulation

	Volt rms / 1 min
Contact open	1000 V
Contact/contact	2.5 kV
Contact/coil	2.5 kV
Insulation resistance at 500 V	≥ 1 GΩ
Insulation, IEC 61810-1	2.5 kV

Specifications

Ambient temperature operation/storage	-40...60 °C / -40 ... 80 °C (no ice)
Pick-up time/bounce time	16 ms/≤ 3 ms
Release time/bounce time	8 ms/≤ 1 ms
Mechanical life ops	AC: 10 Mill./DC: 20 Mill.
DC voltage endurance at rated load	≥ 100 000 switching cycles
Switching frequency at rated load	≤ 1200/h
Weight	43 g

Product References

V AC 50 Hz/60 Hz: 230 (240)

LED

VDC 110

LED

Free wheeling diode (only 24 DC)

Polarity and free wheeling diode

AC/DC bridge rectifier 24 V, 48 V

Other voltages on request

"..." List Coil Voltage to complete Product References

Accessories (See also Section Sockets)

Socket:	S7-C, S7-IO, S7-P,
Push only:	S9-OP (BAG 10 PCS)
Blanking Plug:	S9-NP (BAG 10 PCS)

C7-T21/AC ... V	C7-T22X/AC ... V
C7-T21X/AC ... V	
C7-T21/DC ... V	C7-T22/DC ... V
C7-T21X/DC ... V	C7-T22X/DC ... V
C7-T21DX/DC 24 V	C7-T22X/DC 24 V
C7-T21FX/DC ... V	C7-T22FX/DC ... V
C7-T21BX/UC ... V	C7-T22BX/UC ... V



Connection diagram

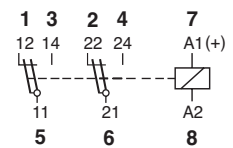

Fig.1 AC voltage endurance

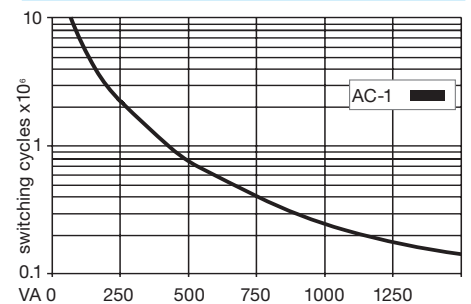
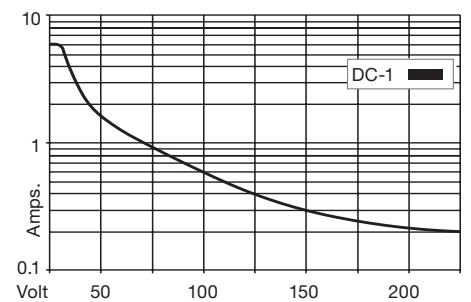
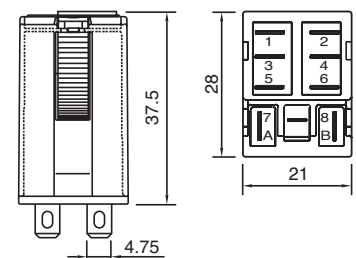

Fig. 2 DC load limit curve



Dimensions



Technical approvals, conformities



IEC/EN 61810; IEC/EN 60947

C7-G2x

2 pole | normally open contact | plug-in Faston

Maximum contact load	10 A/250 V AC-1	0.8 A/110 V DC-1
	10 A/30 V DC-1	0.4 A/220 V DC-1

Contacts

Material	Standard	Code 0	⚡ AgNi
Rated Load			10 A
Switch-on current max. (20 ms)			30 A
Switching voltage max			250 V
AC load (Fig 1)			2.5 kVA
DC load			see fig. 2

Coil

Coil resistance	see table; tolerance ± 10 %
Pick-up voltage	≤ 0.8 × U _N
Release voltage	≥ 0.1 × U _N
Nominal power	1.5 VA (AC)/1.5 W (DC)

Coil table

V AC	Ω	mA	VDC	Ω	mA
24	153	62	12	99	121
48	611	31	24	388	61
115	3K6	13	48	1K5	32
230	14K6	6.5	110	8K	14

Insulation

	Volt rms / 1 min
Contact open	2000 V
Contact/contact	2.5 kV
Contact/coil	2.5 kV
Insulation resistance at 500 V	≥ 1 GΩ
Insulation, IEC 61810-1	2.5 kV

Specifications

Ambient temperature operation/storage	-40...60 °C / -40 ... 80 °C (no ice)
Pick-up time/bounce time	20 ms/≤ 3 ms
Release time/bounce time	10 ms/≤ 1 ms
Mechanical life ops	AC: 10 Mill./DC: 20 Mill.
DC voltage endurance at rated load	≥ 100 000 switching cycles
Switching frequency at rated load	≤ 1200/h
Weight	43 g

Product References

V AC 50 Hz/60 Hz: 24, 48, 115 (120), 230 (240) LED

C7-G20/AC ... V
C7-G20X/AC ... V

VDC 12, 24, 48, 110

LED

C7-G20/DC ... V
C7-G20X/DC ... V
C7-G20FX/DC ... V

Polarity and free wheeling diode

AC/DC bridge rectifier 24 V, 48 V, 60 V

Other voltages on request

C7-G20BX/UC ... V

"..." List Coil Voltage to complete Product References

Accessories (See also Section Sockets)

Socket:	S7-C, S7-IO, S7-P,
Push only:	S9-OP (BAG 10 PCS)
Blanking Plug:	S9-NP (BAG 10 PCS)

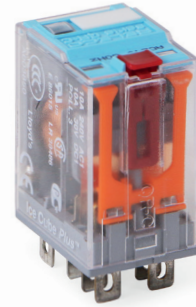

Connection diagram

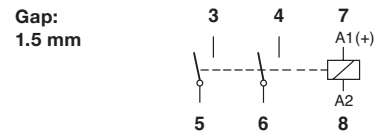

Fig.1 AC voltage endurance

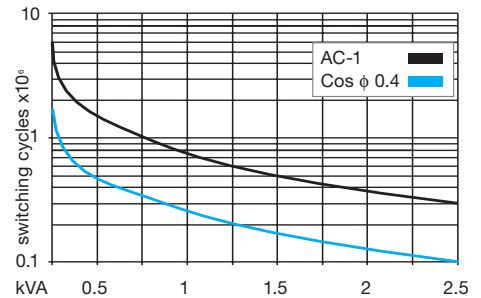
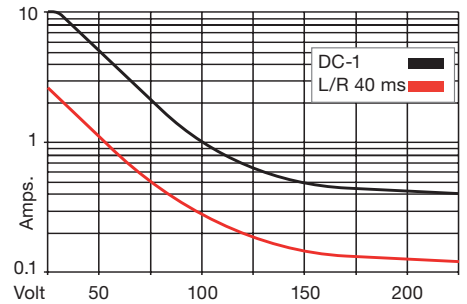
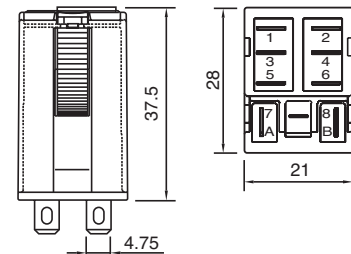

Fig. 2 DC load limit curve



Dimensions



Technical approvals, conformities



C7-H2x

2 pole | changeover contact | plug-in Faston

Maximum contact load	10 A / 250 V AC-1	6 A / 250 V AC-1	6 A / 250 V DC-1
Recommended minimum contact load	10 mA/10 V (Power contacts)	5 mA/5V (twin contacts)	

Contacts	
Material	Standard Code 3 ⚡ ⚡ AgNi + 3 μ Au
Rated Load	10 A
Switch-on current max. (20 ms)	30 A
Switching voltage max.	2,5 kV
AC load (Fig 1)	2,5 VA
DC load	see fig. 2

Coil	
Coil resistance	see table; tolerance ± 10 %
Pick-up voltage	≤ 0.8 x U _n
Release voltage	≥ 0.1 x U _n
Nominal power	1.2 VA (AC)/1 W (DC)

Coil table	V AC	Ω	mA	VDC	Ω	mA
	230	18K6	5.2	24	594	43

Insulation	
Contact open	Volt rms / 1 min
Contact/contact	1000 V
Contact/coil	2.5 kV
Insulation, IEC 61810-1	2.5 kV

Specifications	
Ambient temperature operation/storage	-40...60 °C /-40 ... 80 °C (no ice)
Pick-up time/bounce time	16 ms/≤ 3 ms
Release time/bounce time	8 ms/≤ 1 ms
Mechanical life ops	AC: 10 Mill./DC: 20 Mill.
DC voltage endurance at rated load	≥100 000 switching cycles
Switching frequency at rated load	≤ 1200/h
Weight	43 g

Product References	
LED (only 230 V AC)	C7-H23X/AC 230 V
Free wheeling diode (only 24 DC)	C7-H23X/DC 24 V

Other voltages on request

"..." List Coil Voltage to complete Product References

Accessories (See also Section Sockets)	
Socket:	S7-C, S7-IO, S7-P,
Push only:	S9-OP (BAG 10 PCS)
Blanking Plug:	S9-NP (BAG 10 PCS)



Connection diagram

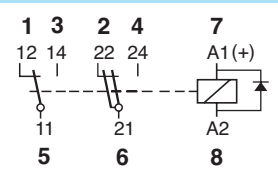

Fig.1 AC voltage endurance

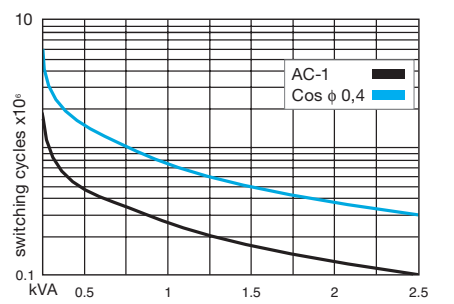
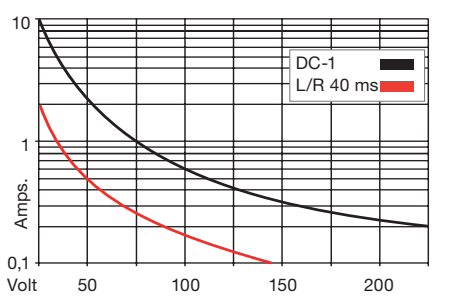
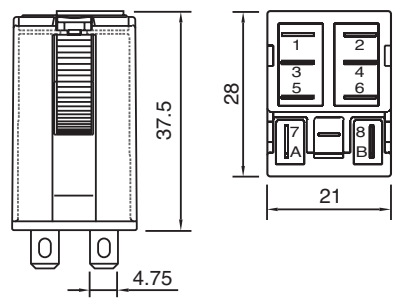

Fig. 2 DC load limit curve



Dimensions



Technical approvals, conformities



C7-X1x

1 pole | normally open serial contact | plug-in Faston

Maximum contact load	10 A/250 V AC-1	6 A/110 V DC-1
	10 A/30 V DC-1	1 A/220 V DC-1

Contacts

Material	Standard	Code 0	⚡ AgNi
Rated Load			10 A
Switch-on current max. (20 ms)			30 A
Switching voltage max.			250 V
AC load			2.5 kVA
DC load			see Fig. 2

Coil

Coil resistance	see table; tolerance ± 10 %
Pick-up voltage	≤ 0.8 × U _N
Release voltage	≥ 0.1 × U _N
Nominal power	1.5 VA (AC)/1.3 W (DC)

Coil table

V AC	Ω	mA	VDC	Ω	mA
24	153	62	12	111	108
48	611	31	24	432	55
115	3K6	13	48	1K7	27
230	14K6	6.5	110	9K2	12

Insulation

Contact open	Volt rms / 1 min	2.5 kV
Contact/coil		2.5 kV
Insulation resistance at 500 V		≥ 1 GΩ
Insulation, IEC 61810-1		2.5 kV

Specifications

Ambient temperature operation/storage	-40...60 °C / -40 ... 80 °C (no ice)
Pick-up time/bounce time	20 ms/≤ 3 ms
Release time/bounce time	10 ms/≤ 1 ms
Mechanical life ops	AC: 10 Mill./DC: 20 Mill.
DC voltage endurance at rated load	≥ 100 000 switching cycles
Switching frequency at rated load	≤ 1200/h
Weight	43 g

Product References

V AC 50 Hz/60 Hz: 24, 48, 115 (120), 230 (240) LED

**C7-X10/AC ... V
C7-X10X/AC ... V**

VDC 12, 24, 48, 110

LED

Free wheeling diode (only 24 DC)

Polarity and free wheeling diode

**C7-X10/DC ... V
C7-X10X/DC ... V
C7-X10DX/DC 24 V
C7-X10FX/DC ... V**

AC/DC bridge rectifier 24 V, 48 V, 60 V

Other voltages on request

C7-X10BX/UC ... V

"..." List Coil Voltage to complete Product References

Accessories (See also Section Sockets)

Socket:	S7-C, S7-IO, S7-P,
Push only:	S9-OP (BAG 10 PCS)
Blanking Plug:	S9-NP (BAG 10 PCS)



Connection diagram

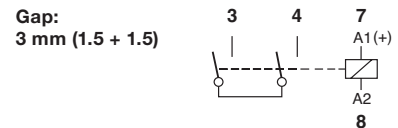

Fig.1 AC voltage endurance

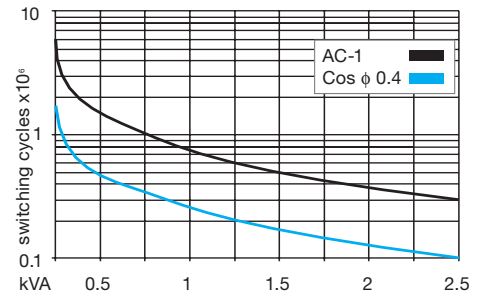
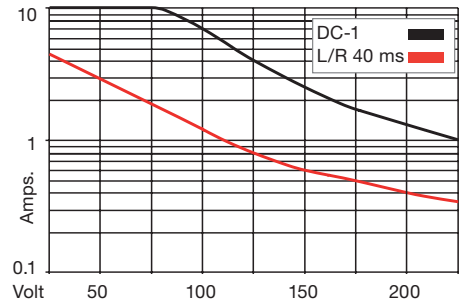
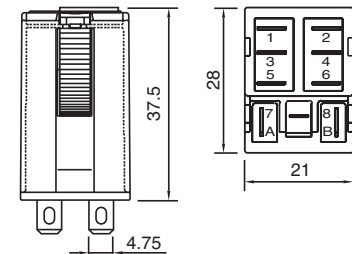

Fig. 2 DC load limit curve



Dimensions



Technical approvals, conformities



IEC/EN 61810; IEC/EN 60947

C7-W1x

1 pole | normally open tungsten pre-contact | plug-in Faston

Maximum contact load:	10 A/250 V AC-1	6 A / 250 V AC-5a/b
Recommended minimum contact load:	10 mA/10 V	

Contacts

Material	Standard	Code 0	⚡ AgNi/W
Rated Load			10 A
Switch-on current max. (2.5 ms)			500 A
Switching voltage max.			250 V
AC load (Fig 1)			2.5 kVA
DC load			see fig. 2

Coil

Coil resistance	see table; tolerance ± 10 %
Pick-up voltage	≤ 0.8 x U _N
Release voltage	≥ 0.1 x U _N
Nominal power	1.5 VA (AC)/1.5 W (DC)

Coil table

V AC	Ω	mA	VDC	Ω	mA
24	153	62	12	99	121
48	611	31	24	388	61
115	3K6	13	48	1K5	32
230	14K5	6.5	110	8K	14

Insulation

Contact open	Volt rms / 1 min
Contact/coil	1000 V
Insulation resistance at 500 V	2.5 kV
Insulation, IEC 61810-1	≥ 1 GΩ
	2.5 kV

Specifications

Ambient temperature operation/storage	-40...60 °C / -40 ... 80 °C (no ice)
Pick-up time/bounce time	20 ms/≤ 3 ms
Release time/bounce time	10 ms/≤ 1 ms
Mechanical life ops	AC: 10 Mill./DC: 20 Mill.
DC voltage endurance at rated load	≥ 100 000 switching cycles
Switching frequency at rated load	≤ 1200/h
Weight	43 g

Product References

V AC 50 Hz/60 Hz: 24, 48, 115 (120), 230 (240) LED

VDC 12, 24, 48, 110

LED

Polarity and free wheeling diode

AC/DC bridge rectifier 24 V, 48 V, 60 V

Other voltages on request

C7-W10/AC ... V
C7-W10X/AC ... V

C7-W10/DC ... V
C7-W10X/DC ... V
C7-W10FX/DC ... V

C7-W10BX/UC ... V

"..." List Coil Voltage to complete Product References

Accessories (See also Section Sockets)

Socket:	S7-C, S7-IO, S7-P,
Push only:	S9-OP (BAG 10 PCS)
Blanking Plug:	S9-NP (BAG 10 PCS)



Connection diagram

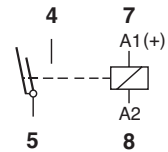

Fig.1 AC voltage endurance

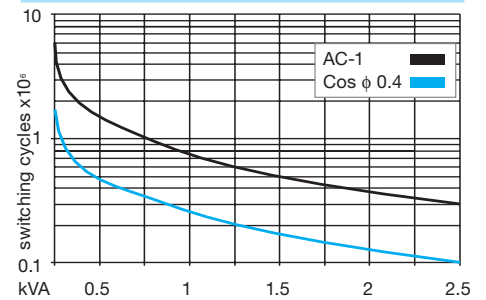
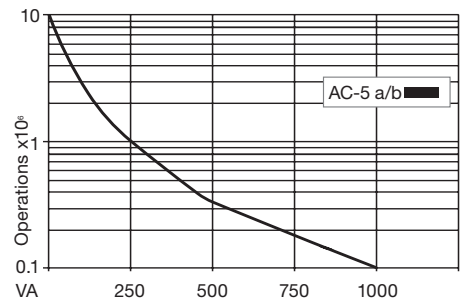
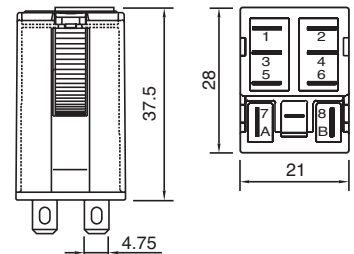

Fig. 2 DC load limit curve



Dimensions



Technical approvals, conformities



IEC/EN 61810; IEC/EN 60947

C9-A4x

4 pole | changeover contact | plug-in Faston

Maximum contact load	5 A/250 V AC-1	5 A/30 V DC-1
Recommended minimum contact load	10 mA/10 V Code 1	
	1 mA/5 V Code 2	

Contacts

Material	Standard	Code 1	AgNi + 0.2 μ Au
	Optional	Code 2	AgNi + 5 μ Au
Rated Load	5 A		
Switch-on current max. (20 ms)	15 A		
Switching voltage max (same polarity)	250 V		
AC load (Fig 1)	1250 VA		
DC load	see Fig. 2		

Coil

Coil resistance	see table; tolerance ± 10 %
Pick-up voltage	≤ 0.8 x U _N
Release voltage	≥ 0.1 x U _N
Nominal power	1.2 VA (AC)/1 W (DC)

Coil table

V AC	Ω	mA	VDC	Ω	mA
24	174	50	12	148	81
48	686	25	24	594	40
115	4K3	10.4	48	2K3	21
230	18K6	5.2	110	11K4	11

Insulation

	Volt rms / 1 min
Contact open	1000 V
Contact/contact	2 kV
Contact/coil	2.5 kV
Insulation resistance at 500 V	≥ 1 GΩ
Insulation, IEC 61810-1	2.5 kV

Specifications

Ambient temperature operation/storage	-40...60 °C / -40 ... 80 °C (no ice)
Pick-up time/bounce time	10 ms/≤ 3 ms
Release time/bounce time	6 ms/≤ 1 ms
Mechanical life ops	AC: 10 Mill./DC: 20 Mill.
DC voltage endurance at rated load	≥ 100 000 switching cycles
Switching frequency at rated load	≤ 1200/h
Weight	43 g

Product References

V AC 50 Hz/60 Hz: **24, 48, 115, 230 (240) LED**

VDC **12, 24, 48, 110**

LED

Free wheeling diode (only 24 DC)

Polarity and free wheeling diode

AC/DC bridge rectifier **24 V, 48 V, 60 V**

Other voltages on request

"..." List Coil Voltage to complete Product References

Accessories (See also Section Sockets)

Socket:	S9-M, S9-P
Push only:	S9-OP (BAG 10 PCS)
Blanking Plug:	S9-NP (BAG 10 PCS)

C9-A41/AC ... V	C9-A42/AC ... V
C9-A41X/AC ... V	C9-A42X/AC ... V
C9-A41/DC ... V	C9-A42/DC ... V
C9-A41X/DC ... V	C9-A42X/DC ... V
C9-A41DX/DC 24 V	C9-A42DX/DC 24 V
C9-A41FX/DC ... V	C9-A42FX/DC ... V
C9-A41BX/UC ... V	C9-A42BX/UC ... V



Connection diagram

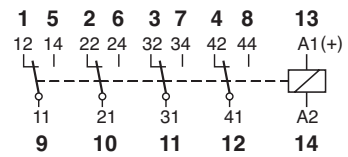

Fig.1 AC voltage endurance

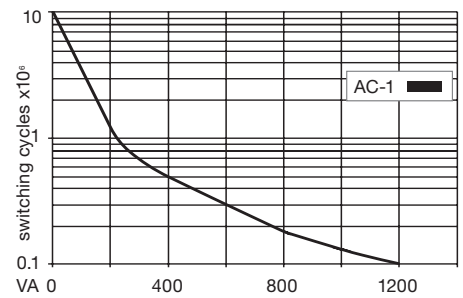
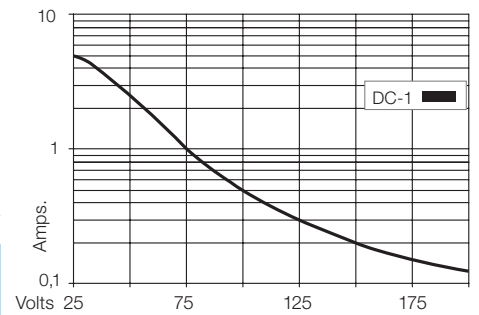
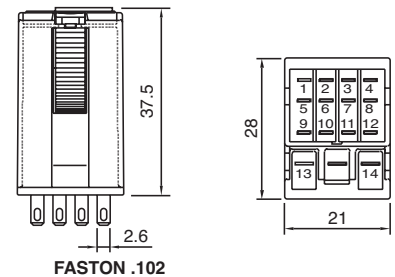

Fig. 2 DC load limit curve



Dimensions



Technical approvals, conformities



IEC/EN 61810; IEC/EN 60947

Warning: Maximum voltage between two separate circuits on neighbouring contacts: 150 V
Not permitted: 24 V DC next to 230 V AC, 230 V AC next to neutral, 230 V AC next to 230 V AC of different phases
Permitted: 230 V AC next to 230 V AC same phase

C9-E2x

2 pole | changeover contact | sensitive coil | plug-in Faston

Maximum contact load	5 A/250 V AC-1	5 A/30 V DC-1
Recommended minimum contact load	10 mA/10 V Code 1	

Contacts

Material	Standard	Code 1	AgNi + 0.2 µ Au
Rated Load			5 A
Switch-on current max. (20 ms)			15 A
Switching voltage max.			250 V
AC load (Fig 1)			1200 VA
DC load			see fig. 2

Coil

Coil resistance	see table; tolerance ± 10 %
Pick-up voltage	≤ 0.8 x U _N
Release voltage	≥ 0.1 x U _N
Nominal power	0.8 VA (AC)/0.5 W (DC)

Coil table

V AC	Ω	mA	VDC	Ω	mA
24	238	33	12	288	42
48	1K	17	24	1K1	21
115	5K9	7	48	4K6	10
230	23K9	3.5	110	24K2	4.5

Insulation

Contact open	Volt rms / 1 min
Contact/contact	1000 V
Contact/coil	2.5 kV
Insulation resistance at 500 V	≥ 1 GΩ
Insulation, IEC 61810-1	2.5 kV

Specifications

Ambient temperature operation/storage	-40...60 °C / -40 ... 80 °C (no ice)
Pick-up time/bounce time	10 ms/≤ 3 ms
Release time/bounce time	6 ms/≤ 1 ms
Mechanical life	AC: 10 Mill./DC: 20 Mill.
DC voltage endurance at rated load	≥ 100 000 switching cycles
Switching frequency at rated load	≤ 1200/h
Weight	40 g

Product References

V AC 50 Hz/60 Hz: 24, 48, 115, 230 (240) LED

VDC 12, 24, 48, 110, 220

LED

Free wheeling diode (only 24 DC)

Polarity and free wheeling diode

AC/DC bridge rectifier 24 V, 48 V, 60 V

Other voltages on request

C9-E21/AC ... V
C9-E21X/AC ... V

C9-E21/DC ... V
C9-E21X/DC ... V
C9-E21DX/DC 24 V
C9-E21FX/DC ... V

C9-E21BX/UC ... V

"..." List Coil Voltage to complete Product References

Accessories (See also Section Sockets)

Socket:	S9-M, S9-P
Push only:	S9-OP (BAG 10 PCS)
Blanking Plug:	S9-NP (BAG 10 PCS)



Maximum voltage between two separate circuits on neighbouring contacts: 150 V
Not permitted: 24 V DC next to 230 V AC, 230 V AC next to neutral, 230 V AC next to 230 V AC of different phases
Permitted: 230 V AC next to 230 V AC same phase



Connection diagram

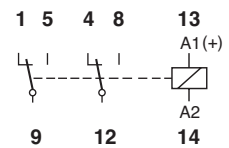

Fig.1 AC voltage endurance

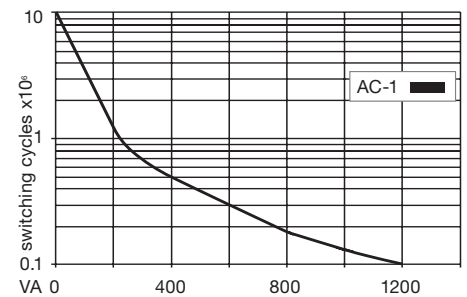
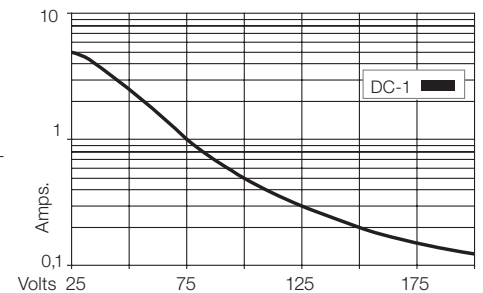
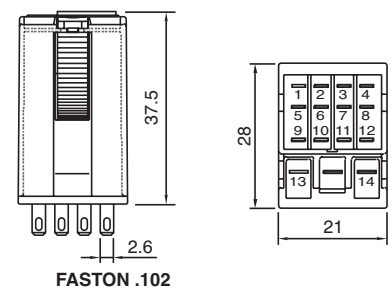

Fig. 2 DC load limit curve



Dimensions



Technical approvals, conformities



IEC/EN 61810; IEC/EN 60947

C9-R2x

2 pole | changeover contact | retentive | plug-in Faston

Maximum contact load	5 A/120V AC-1	5 A/30 V DC-1
Recommended minimum contact load	10 mA/10 V	

Contacts

Material	Standard	Code 1	AgNi + 0.2 μ Au
Rated Load			5 A
Switch-on current max. (20 ms)			15 A
Switching voltage max.			120V
AC load			600 VA
DC load			see Fig. 2

Coil

Coil resistance	see table; tolerance ± 10 %
ON pulse power	1.2 VA/W
OFF pulse power	0.3 VA/W
1 winding for AC, 2 winding for DC	

Internal Diagram:

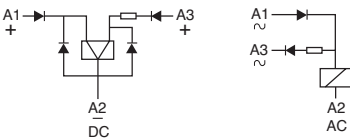

Coil table

V AC	mA ON	mA OFF	VDC	mA ON	mA OFF
24	50	8	12	100	25
48	25	4	24	50	12
115	10	2	48	25	6
230	5	1	60	20	5

Insulation

Contact open	Volt rms / 1 min
Contact/contact	1000 V
Contact/coil	2 kV
Insulation resistance at 500 V	2 kV
Insulation, IEC 61810-1	≥1 GΩ
	2.5 kV

Specifications

Ambient temperature operation/storage	-40...60 °C / -40 ... 80 °C (no ice)
Minimum pulse ON/OFF	50 ms
Mechanical life	AC: 10 Mill./DC: 20 Mill.
DC voltage endurance at rated load	≥100 000 switching cycles
Switching frequency at rated load	≤ 1200/h
Weight	43 g

Product References

AC 50 Hz/60 Hz: 24, 48, 115, 230

C9-R21/AC ... V

DC 12, 24, 48, 60

C9-R21/DC ... V

Other voltages on request

"..." List Coil Voltage to complete Product References

Accessories (See also Section Sockets)

Socket:	S9-M, S9-P
Push only:	S9-OP (BAG 10 PCS)
Blanking Plug:	S9-NP (BAG 10 PCS)

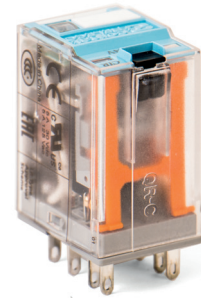

Connection diagram

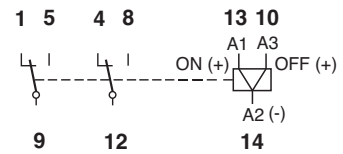

Fig.1 AC voltage endurance

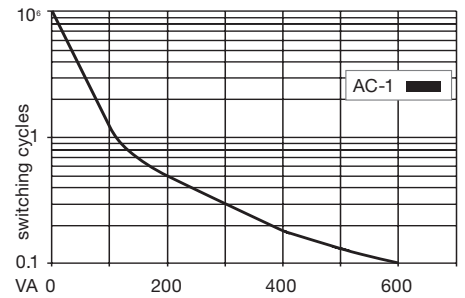
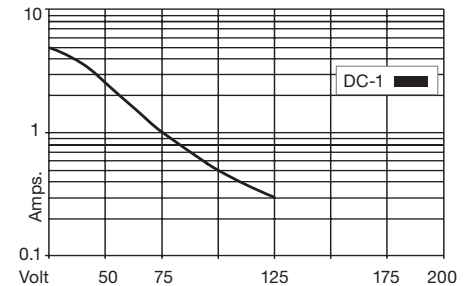
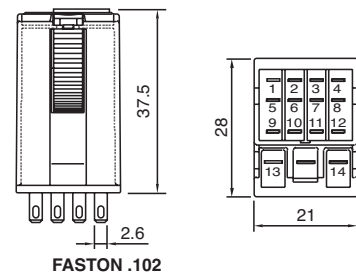

Fig. 2 DC load limit curve



Dimensions





Technical approvals, conformities



IEC/EN 61810; IEC/EN 60947

Warning: Maximum voltage between two separate circuits on neighbouring contacts: 150 V
Not permitted: 24 V DC next to 230 V AC, 230 V AC next to neutral, 230 V AC next to 230 V AC of different phases
Permitted: 230 V AC next to 230 V AC same phase

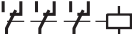
1.4 Extended Lifetime Relays

Application	Types	Pins	Contacts	Contact ratings	Socket
C3x Series					
Long Life, Railway	C31			10 A / 250 V	S3
Long Life, reliable switching of lower loads, Railway	C32			5 A / 250 V	S3

C31

3 pole | changeover contact | plug-in



Maximum contact load	10 A / 250 V AC-1
	10 A / 30 V DC-1
Recommended minimum contact load	50 mA / 10 V

Contacts

Material	⚡ AgCuNi
Rated operational current	10 A
Max. inrush current (20 ms)	40 A
Rated switching voltage	250 V
Max. AC load	2500 VA AC-1
Max. DC load 30V / 230V DC-1 (Fig. 2)	300W / 90 W

Coils (Values are valid at 20 °C)

Pick-up voltage	$\leq 0.8 \times U_N$
Release voltage AC / DC	$> 0.15 \times U_N / > 0.05 \times U_N$
Nominal power AC / DC	2.5 VA / 1.2 W

Coil Table

V _N AC	Ω	mA	V _N DC	Ω	mA
24	52	104	12	115	104
48	240	55	24	480	50
115	1350	23	48	1850	26
230	5600	11.5	110	9000	12
			220	29000	7.6

Types with LED indicator take additional 5 ... 10 mA @ < 80 V

Insulation

Contact Open	1.5 kV rms / 1 min
Contact Contact	1.5 kV rms / 1 min
Contact Coil	2 kV rms / 1 min

Specifications

Ambient temperature operation, storage	-40 ... +70 °C (no ice)
Pickup time AC / DC	3 ... 10 ms / ≤ 12 ms
Release time AC / DC	2 ... 15 ms / ≤ 3.5 ms
Bounce time NO contact AC / DC	3 ... 6 ms / approx. 3.5 ms
Mechanical life	$\geq 100\ 000\ 000$ operations
Operating frequency at nominal load	≤ 360 operations / h
Weight	80 g

Product References

AC 50 Hz / 60 Hz: 24, 48, 115, 230 (240)

LED

DC: 12, 24, 48, 110, 220

Free wheeling diode

LED + Free wheeling diode

Railway EN 50155

- C31/AC...V**
- C31L/AC...V**
- C31/DC...V**
- C31D/DC...V**
- C31DL/DC...V**
- C31D/R DC...V**

"..." List Coil Voltage to complete Product References

Accessories

Socket:	S3-B, S3-S, S3-L, S3-PO, S3-MB0, S3-MB1
Blanking Plug:	SO-NP (BAG 10 PCS)



Connection diagram

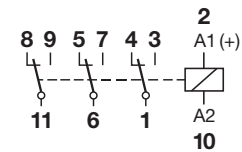

Fig.1 AC voltage endurance

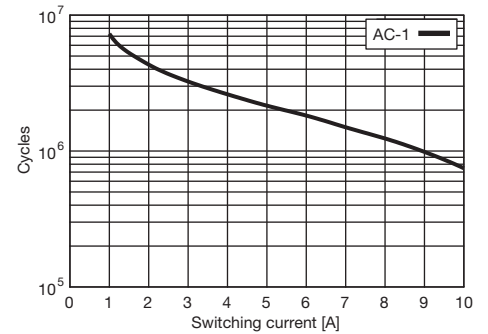
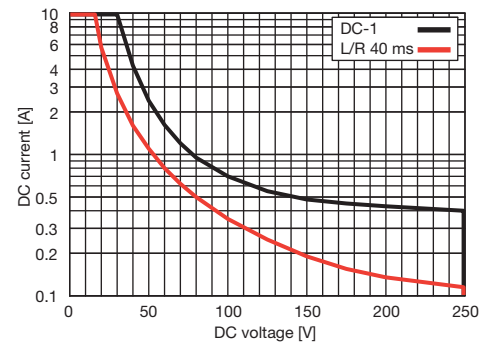
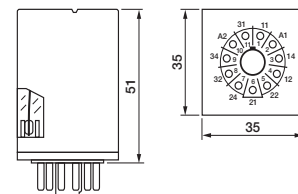

Fig. 2 DC load limit curve



Dimensions



Technical approvals, conformities



IEC/EN 61810; IEC/EN 60947; IEC/EN 50155
IEC/EN 61373; IEC/EN 45545
NF F 16-101/102

C32

3 pole | changeover twin contact | plug-in



TURCK

comat RELECO
WORLD OF RELAYS

Maximum contact load	6 A / 250 V AC-1
	6 A / 30 V DC-1
Recommended minimum contact load	1 mA / 5 V

Contacts	
Material	AgCuNi
Rated operational current	6 A
Max. inrush current (20 ms)	15 A
Rated switching voltage AC-1	250 V
Max. AC load	1500 VA AC-1
Max. DC load 30V / 230V DC-1 (Fig. 2)	200 W / 90 W

Coils (Values are valid at 20 °C)	
Pick-up voltage	$\leq 0.8 \times U_N$
Release voltage AC / DC	$> 0.15 \times U_N / > 0.05 \times U_N$
Nominal power AC / DC	2.5 VA / 1.2 W

Coil Table					
V_N AC	Ω	mA	V_N DC	Ω	mA
24	52	104	12	115	104
48	240	55	24	480	50
115	1350	23	48	1850	26
230	5600	11.5	110	9000	12
			220	29000	7.6

Types with LED indicator take additional 5 ... 10 mA @ < 80 V

Insulation	
Contact Open	1.5 kV rms / 1 min
Contact Contact	1.5 kV rms / 1 min
Contact Coil	2 kV rms / 1 min

Specifications	
Ambient temperature operation, storage	-40 ... +70 °C (no ice)
Pickup time AC / DC	3 ... 10 ms / ≤ 12 ms
Release time AC / DC	2 ... 15 ms / ≤ 3.5 ms
Bounce time NO contact AC / DC	3 ... 6 ms / approx. 3.5 ms
Mechanical life	$\geq 100\ 000\ 000$ operations
Operating frequency at nominal load	≤ 360 operations / h
Weight	80 g

Product References
AC 50 Hz / 60 Hz: 24, 48, 115, 230 (240)
LED
DC: 12, 24, 48, 110, 220
Free wheeling diode
LED + Free wheeling diode
Railway EN 50155

C32/AC...V
C32L/AC...V
C32/DC...V
C32D/DC...V
C32DL/DC...V
C32D/R DC...V

"..." List Coil Voltage to complete Product References

Accessories	
Socket:	S3-B, S3-S, S3-L, S3-PO, S3-MB0, S3-MB1
Blanking Plug:	SO-NP (BAG 10 PCS)



Connection diagram

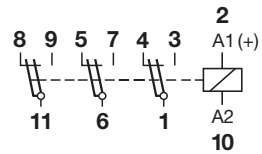

Fig.1 AC voltage endurance

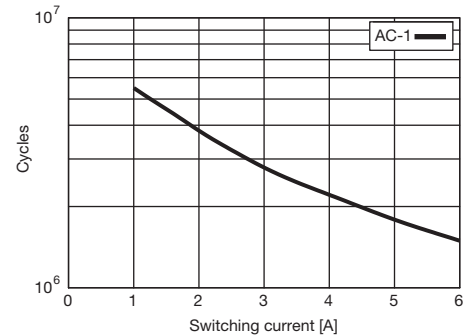
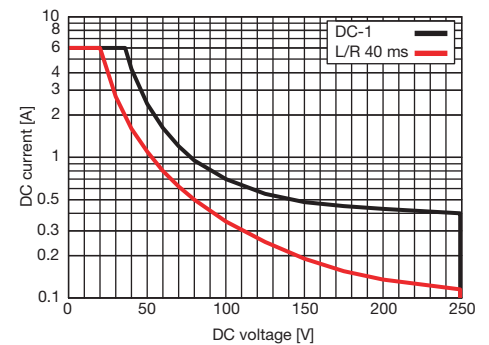
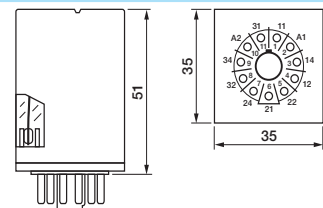

Fig. 2 DC load limit curve



Dimensions













Technical approvals, conformities



IEC/EN 61810; IEC/EN 60947; IEC/EN 50155
 IEC/EN 61373; IEC/EN 45545
 NF F 16-101/102

1.5 Solid State Relays

Application	Types	Pins	Contacts	AC ratings	DC ratings	Socket
CSS Series						
AC Solid state relay, Instantaneous switching	CSS-I			3 A / 250 V	-	S10
AC Solid state relay synch. to zero crossing	CSS-Z			3 A / 250 V	-	S10
NPN Solid state relay	CSS-N			-	6 A / 48 V	S10
PNP Solid state relay	CSS-P			-	6 A / 48 V	S10
CRINT Series						
DC solid state switch	CRINT-1x5			-	2 A / 24 V	-
AC solid state switch	CRINT-1x8			1 A / 240 V	-	-

CSS-I

1 pole | normally open solid state AC | plug-in Faston



Output	1 N/O contact
Operating range	3 A, 24 ... 250 V AC, 50/60 Hz
Minimum contact load	35 mA

Control circuit	
Input voltage range	5 ... 48 VDC
Input current	10 mA

Output circuit	Instantaneous
Max. output current	3 A
Min. output current	35 mA
Output voltage range	24...250 V AC
Inrush current	150 A/10 ms
Residual current	1 mA
I ² t value	210 A ² s

Specifications	
Ambient temperature operation/storage	-40 ... 70 °C / -40 ... 85 °C (no ice)
Pick-up time	0.06 ms
Release time	0.06 ms
Weight	28 g

Applications

It is specially suitable to switch inductive loads up to 3A/250 V AC. For switching loads with a high inrush or overcurrent as transformers, motors or fluorescents, the maximum output current will limit to 2 A.

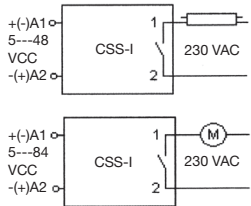

Product References

VDC 5-48 **CSS-I12X/DC5-48V**

Accessories

Socket: **S10, S10-P**



Fig. 1 CSS-I diagram

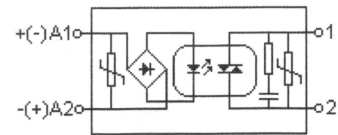

Tab. 2 AC derating curve

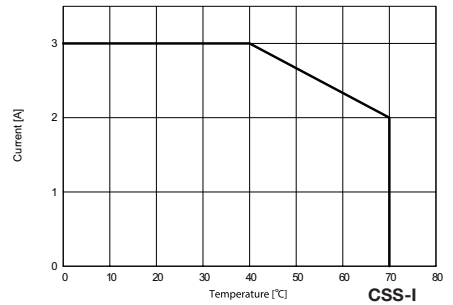

Dimensions

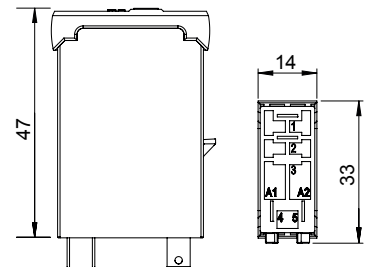

Technical approvals, conformities



IEC/EN 60947

CSS-Z

1 pole | normally open solid state AC | plug-in Faston



Output	1 N/O contact
Operating range	3 A, 24 ... 250 V AC, 50/60 Hz
Minimum contact load	35 mA

Control parameters	
Input voltage range	5 ... 48 VDC
Input current	10 mA

Output	Synchronized zero
Max. output current	3 A
Min. output current	35 mA
Output voltage range	24 ... 250 V AC
Inrush current	150 A/10 ms
Residual current	1 mA
I _t value	210 A's

Specifications	
Ambient temperature operation/storage	-40...70 °C / -40 ... 85 °C (no ice)
Pick-up time	10 ms
Release time	10 ms
Weight	28 g

Applications

Switches ohmic AC loads up to 3 A/250 V AC in the zero-point of the tension and avoids any over-current peak in the connection. Suitable for switching resistors, incandescent lamps, signalling equipment, etc. Not suitable for inductive loads

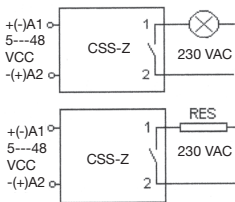

Product References

VDC 5-48 **CSS-Z12X/DC5-48V**

Accessories

Socket: **S10, S10-P**



Fig. 1 CSS-Z diagram

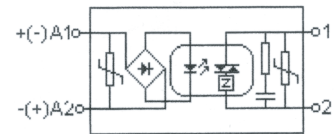

Tab. 2 AC derating curve

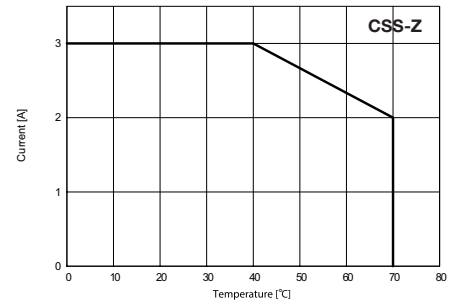

Dimensions

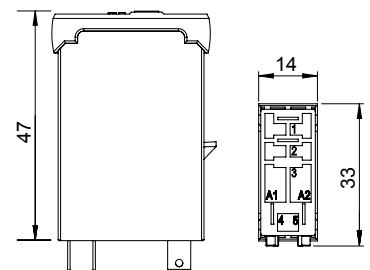

Technical approvals, conformities



IEC/EN 60947

CSS-N

1 pole | normally open solid state DC | plug-in Faston



Output	1 N/O contact
Operating range	6 A, 5 ... 48 VDC
Minimum contact load	1 mA

Control parameters	
Input voltage range	5 ... 48 VDC
Input current	4 mA

Output	
Type	NPN
Max. output current	6 A
Output voltage range	5 ... 48 VDC
Switch-on current max.	40 A / 10 ms
Max. voltage drop	≤ 0.14 VDC
Residual current	0.1 mA

Specifications	
Ambient temperature operation/storage	-40 ... 70 °C / -40 ... 85 °C (no ice)
Test voltage between input/output	4 kV rms/1 min.
Turn-on delay	0.06 ms
Release delay	0.06 ms
Weight	28 g

Applications

For switching heating elements, electro valves, motors, PLC input/output signals, solenoids, incandescent and fluorescent lamps, etc. (up to 48 VDC).

Inductive loads must be shunted with an antiparallel diode.

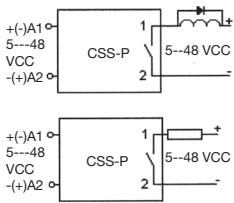

Product References

VDC 5–48

CSS-N13X/DC5–48V

Accessories

Socket:

S10, S10-P



Fig. 1 CSS-N diagram

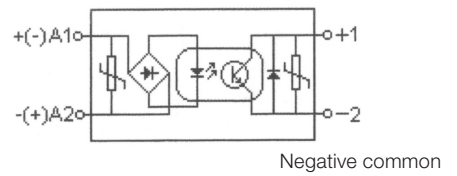

Tab. 2 AC derating curve

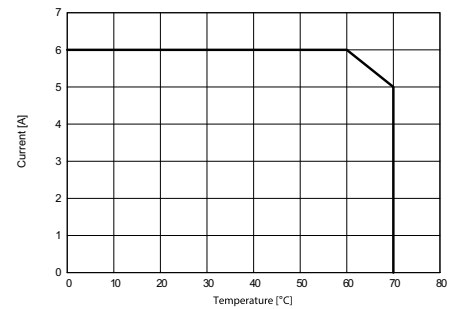

Dimensions

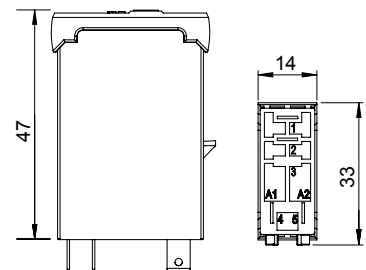

Technical approvals, conformities



IEC/EN 60947

CSS-P

1 pole | normally open solid state DC | plug-in Faston



Output	1 N/O contact
Operating range	6 A, 5 ... 48 VDC
Minimum contact load	1 mA
Control parameters	
Input voltage range	5 ... 48 VDC
Input current	4 mA
Output	
Type	PNP
Max. output current	6 A
Output voltage range	5 ... 48 VDC
Max. switch-on current	40 A / 10 ms
Max. voltage drop	0.14 VDC
Residual current	0.1 mA
Specifications	
Ambient temperature operation/storage	-40 ... 70 °C / -40 ... 85 °C (no ice)
Turn-on delay	0.06 ms
Release delay	0.06 ms
Weight	28 g

Applications

For switching heating elements, electro valves, motors, PLC input/output signals, solenoids, incandescent and fluorescent lamps, etc. (up to 48 VDC).

Inductive loads must be shunted with an antiparallel diode.

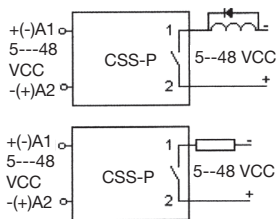

Product References

VDC 5–48 **CSS-P13X/DC5–48V**

Accessories

Socket: **S10, S10-P**



Fig. 1 CSS-P diagram

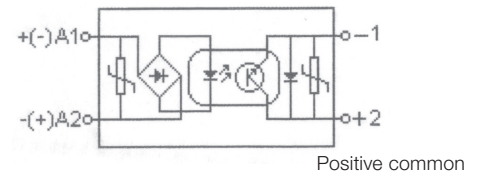

Tab. 2 AC derating curve

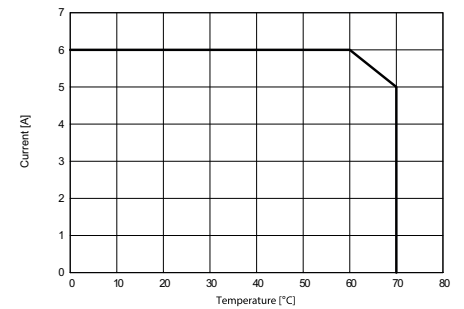

Dimensions

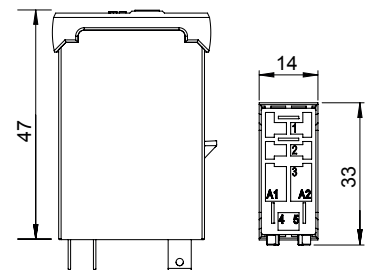

Technical approvals, conformities



IEC/EN 60947

Max. contact load	2 A, 24 V DC-1
Contact	 Type: 1 NO (Solid state DC) Material: Mosfet Switching current _{TH} : 2 A 24 V DC Recommended minimal load: 20 mA / 5 V Peak inrush current: 48 A/10 ms
Coil	Operation voltage AC 50/60 Hz / DC: 0.8 ... 1.25 U _N Nominal power DC/AC: 160 / — mW
Insulation	Test voltage I / O: 2.5 kV rms / 1 min Pollution degree: 3 Over voltage category: III Open contact: 1000 Vrms dielectric strength 1 min Standard: EN61810-5
Specifications	Ambient temperature: operation / storage: -30 ... +70 °C / -40 ... +85 °C (no ice) Typical response time @ V _n : 1 ms Typical release time @ V _n : 1 ms Cond. cross section screw terminal: 2.5 mm ² Cond. cross section spring cage: 0.75 ... 2.5 mm ² Protection degree: IP 20 Mounting position: any, TS-35 or Back Panel Mounting Housing material: Polyamide PA6

Product References	
Screw terminal: CRINT-C115/UC...V	UC12V UC24V UC48V UC60V UC110-125V UC220-240V
Cage clamp terminal: CRINT-C125/UC...V	
"..." List Coil Voltage to complete Product References	

Accessories	
Jumper link:	blue: CRINT-BR20-BU (BAG 5 PCS) red: CRINT-BR20-RD (BAG 5 PCS) black: CRINT-BR20-BK (BAG 5 PCS)
Label plate:	CRINT-LAB (BAG 4x16 PCS)
Spacer:	CRINT-SEP (BAG 5 PCS)
Replacement relays:	
CRINT-R15/DC...V	
"..." List Coil Voltage to complete Product References	

60V Relay used for all sockets with a nominal voltage higher or equal 60V	DC12V DC24V DC48V DC60V
--	-----------------------------------

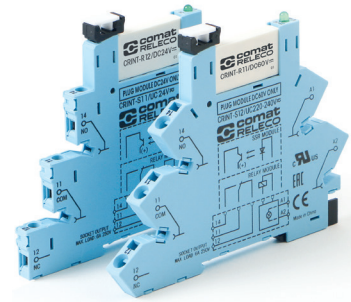

Connection diagram

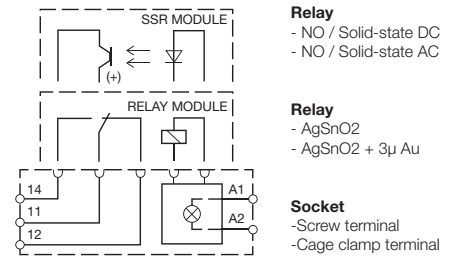

Fig.1 AC voltage endurance

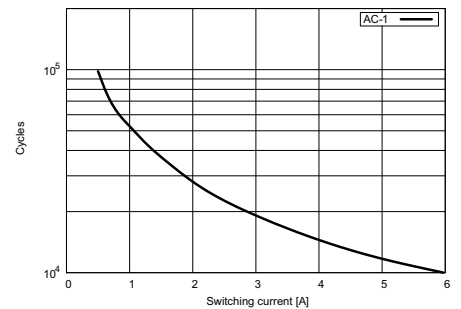
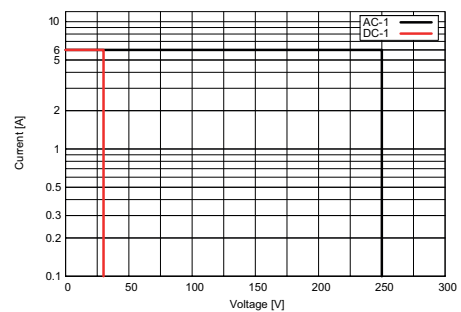
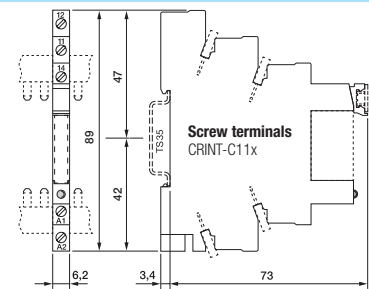

Fig. 2 DC load limit curve



Dimensions



Technical approvals, conformities



IEC/EN 60810

Contact	
Type	1 NO (Solid state AC)
Material	Triac
Switching current _{TH}	1 A 240 V AC
Recommended minimal load	22 mA / 12 V
Peak inrush current	80 A/10 ms

Coil	
Operation voltage AC 50/60 Hz / DC	0.8 ... 1.25 U _N
Nominal power DC/AC	150 / — mW

Insulation	
Test voltage I / O	2.5 kV rms / 1 min
Pollution degree	3
Over voltage category	III
Open contact	1000 Vrms dielectric strength 1 min
Standard	EN61810-5

Specifications	
Ambient temperature: operation / storage	-30 ... +70 °C / -40 ... +85 °C (no ice)
Typical response time @ V _n	1 ms
Typical release time @ V _n	1 ms
Cond. cross section screw terminal	2.5 mm ²
Cond. cross section spring cage	0.75 ... 2.5 mm ²
Protection degree	IP 20
Mounting position	any, TS-35 or Back Panel Mounting
Housing material	Polyamide PA6

Product References	
Screw terminal: CRINT-C118/UC...V	UC12V UC24V UC48V UC60V UC110-125V UC220-240V
Cage clamp terminal: CRINT-C128/UC...V	
"..." List Coil Voltage to complete Product References	

Accessories	
Jumper link:	blue: CRINT-BR20-BU (BAG 5 PCS) red: CRINT-BR20-RD (BAG 5 PCS) black: CRINT-BR20-BK (BAG 5 PCS)
Label plate:	CRINT-LAB (BAG 4x16 PCS)
Spacer:	CRINT-SEP (BAG 5 PCS)

Replacement relays:	
CRINT-R18/DC...V	
"..." List Coil Voltage to complete Product References	

60V Relay used for all sockets with a nominal voltage higher or equal 60V	DC12V DC24V DC60V
--	---

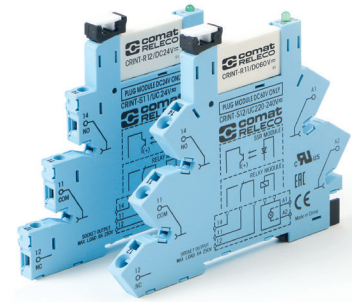

Connection diagram

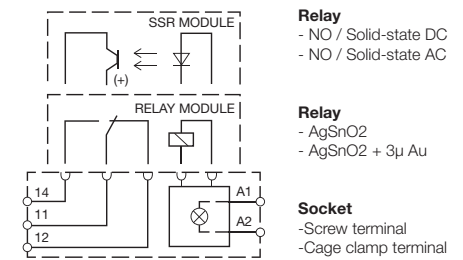

Fig.1 AC voltage endurance

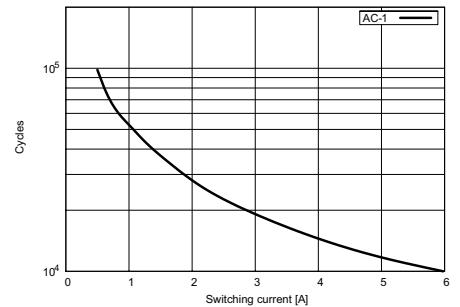
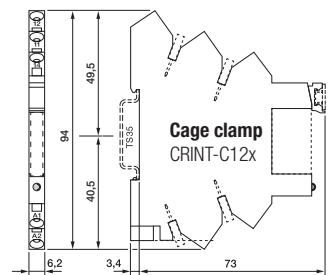

Fig. 2 DC load limit curve

Dimensions



Technical approvals, conformities



IEC/EN 60810

1.6 Installation Relays

Application	Types	Contacts	AC ratings	DC ratings
CHI Series				
1-Pole High Inrush Relay	CHI14	1	16 A / 250 V	-
3-Pole High Inrush Relay	CHI34	3+1	16 A / 250 V	-

CHI14

1-Pole High Inrush Relay

Maximum contact load	16 A / 250 V AC-1
Recommended minimum contact load	100 mA / 12 V

Contacts	
Material	⚡ W / AgSnO ₂
Rated operational current at 40 °C / 60 °C	16 A / 13 A
Max. inrush current	165 A / 20 ms 800 A / 200 μs
Max. switching voltage AC-1	250 V
Max. AC load AC-1 (Fig.1)	4 kVA

Power supply- and control input	
Nominal voltage (A1, B1)	UC 24-240 V (UC = AC / DC)
Operating voltage range	16.8 ... 250 V
Power consumption	1.2 VA / 0.43 W
Frequency range	16 ... 60 Hz

Insulation	
Test voltage open contact	1 kV rms / 1 min
Test voltage between contacts and control input	2.5 kV rms / 1 min

General Specifications	
Ambient temperature storage /operation	-40 ... 85 °C / -40 ...60 °C (no ice)
Mechanical life of contact	5 x 1 000 000 operations
Conductor cross section	Stranded wire 2.5 mm ² , 2 x 1.5 mm ²
Protection degree	IP 20
Nominal screw torque	0.4 Nm
Housing material	Lexan
Weight	70 g

Product References	
UC (AC/DC) 15...60 Hz	CHI14/UC24-240V



Connection diagram

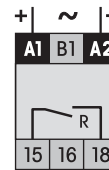

Fig.1 AC voltage endurance

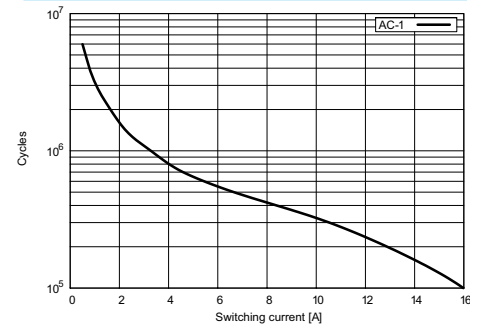
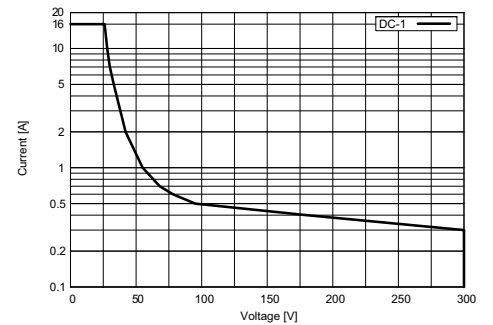
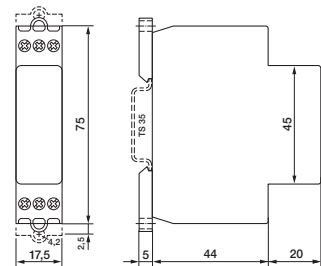

Fig. 2 DC load limit curve



Dimensions



Technical approvals, conformities



CHI34

3-Pole High Inrush Relay

Maximum contact load	16 A / 250 V AC-1
Recommended minimum contact load	100 mA / 12 V

Contacts	
Number of contacts	3
Material	W / AgSnO ₂
Rated operational current at 40 °C / 60 °C	16 A / 13 A
Max. inrush current	165 A / 20 ms 800 A / 200 µs
Max. switching voltage AC-1	250 V
Max. AC load AC-1 (Fig.1)	4 kVA

Auxiliary Contacts	
Number of contacts	1
Nominal current at 25°C/60°C	90 mA/60 mA
Inrush current	1 A/100 µs
Nominal voltage AC/DC	24 V
Contact Material	Semiconductor

Supply U_B (1-N)	
Nominal operating voltage (AC/DC)	110...240 V
Operating voltage (AC/DC)	80...250 V
Frequency range	47...63 Hz
Power consumption	3.45 VA

Power supply- and control input	
Nominal voltage (A1, A2)	UC 24-240 V (UC = AC / DC)
Operating voltage range	16.8 ... 250 V
Power consumption	30 VA / 30 mW
Frequency range	47...63 Hz

Insulation	
Test voltage open contact	1 kV rms / 1 min
Test voltage between contacts and control input	2.5 kV rms / 1 min
Test voltage between contacts	2.5 kV rms / 1 min

General Specifications	
Ambient temperature storage /operation	-40 ... 85 °C / -25 ...60 °C (no ice)
Mechanical life of contact	5 x 1 000 000 operations
Conductor cross section	Stranded wire 2.5 mm ² , 2 x 1.5 mm ²
Protection degree	IP 20
Nominal screw torque	0.6 Nm
Housing material	Lexan
Weight	125 g

Product References	CHI34/UC24-240V
UC (AC/DC) 47...63 Hz	



Connection diagram

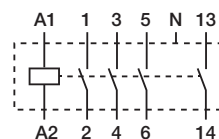

Fig.1 AC voltage endurance

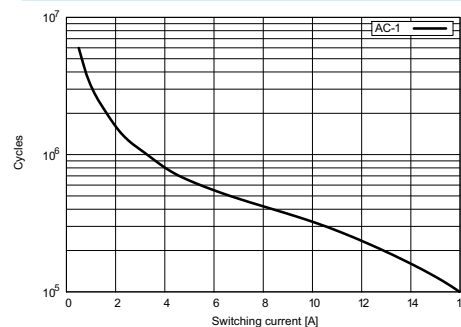
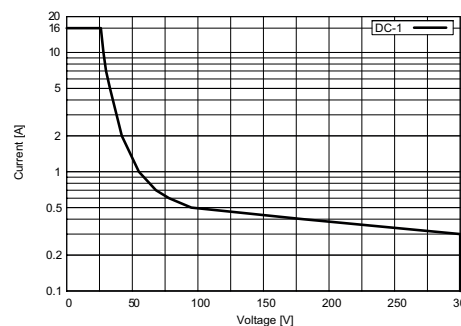
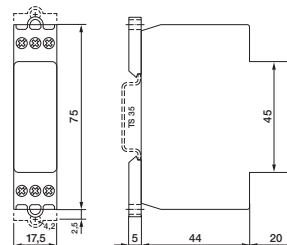

Fig. 2 DC load limit curve



Dimensions



Technical approvals, conformities



1.8 Solid State Contactors

Application	Types	AC ratings	DC ratings
CC1 Series			
15 A Single phase 230 V AC	CC1H215	15 A / 230 V AC	-
30 A Single phase 230 V AC	CC1H230	30 A / 230 V AC	-
50 A Single phase 230 V AC	CC1H250	50 A / 230 V AC	-
15 A Single phase 400 V AC	CC1H415	15 A / 400 V AC	-
30 A Single phase 400 V AC	CC1H430	30 A / 400 V AC	-
50 A Single phase 400 V AC	CC1H450	50 A / 400 V AC	-
CC3 Series			
10 A Triple phase 400 V AC	CC3H410	10 A / 400 V AC	-
20 A Triple phase 400 V AC	CC3H420	20 A / 400 V AC	-
CCR Series			
10 A Three phase reversing contactor 400 V AC	CCR3H410	10 A / 400 V AC	-
CPC Series			
30 A Single phase 400 V AC	CPC1230	30 A / 400 V AC	-
50 A Single phase 230 V AC	CPC1250	50 A / 230 V AC	-
30 A Single phase 400 V AC	CPC1430	30 A / 400 V AC	-
50 A Single phase 400 V AC	CPC1450	50 A / 400 V AC	-

CC1H215

15A | Single phase 230 V AC



Output

Switching element	Thyristor
Numbers of phases	1
Nominal voltage (U _{nom})	230 V AC
Output voltage range	12 – 240 V AC
Frequency	50/60 Hz
Reverse voltage	1000 V _{rrm}
Peak reverse voltage	1100 V _{rsm}
Min. load	10 mA
Max. leakage current	1 mA
Operation current AC-1/51 @ U _{nom}	15 A
Operation current AC-3 @ U _{nom}	15 A
Operation current AC-55b @ U _{nom}	15 A
Operation current AC-56a @ U _{nom}	15 A
Response/Release time	20 ms
Limit load	1800 A ² s

Input

Voltage	24 – 230 V AC/DC
Min. voltage	20.4 V AC/DC
Max. voltage	253 V AC/DC
Release voltage	7.2 V AC/DC
Max. current	6 mA

Insulation

Insulation voltage	4 kV
Dielectric strength	660 V

Specifications

Ambient temperature storage/operation	-20 ... 80°C / -5 ... 40°C (no ice)
Connection terminals	Screw terminal 6 mm ²
Protection degree	IP 20
Mounting	TS-35 or Back Panel Mounting
Housing material	PPE / Aluminium
Weight	270 g

Product References

Solid State Contactor 1ph.

CC1H215



Connection diagram

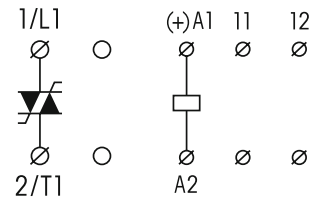

Dimensions

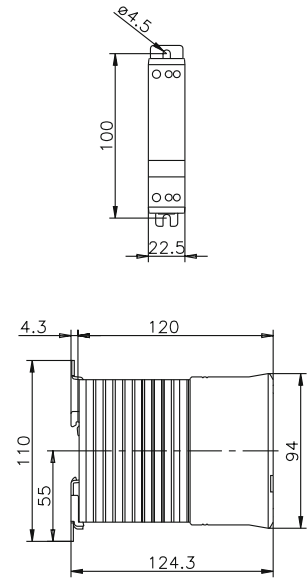

Technical approvals, conformities



IEC/EN 60947-4-3

CC1H230

30 A | Single phase 230 V AC



Output

Switching element	Thyristor
Numbers of phases	1
Nominal voltage (U _{nom})	230 V AC
Output voltage range	12 – 240 V AC
Frequency	50/60 Hz
Reverse voltage	1000 V _{rrm}
Peak reverse voltage	1100 V _{rsm}
Min. load	10 mA
Max. leakage current	1 mA
Operation current AC-1/51 @ U _{nom}	30 A
Operation current AC-3 @ U _{nom}	15 A
Operation current AC-55b @ U _{nom}	20 A
Operation current AC-56a @ U _{nom}	15 A
Response/Release time	20 ms
Limit load	1800 A ² s

Input

Voltage	24 – 230 V AC/DC
Min. voltage	20.4 V AC/DC
Max. voltage	253 V AC/DC
Release voltage	7.2 V AC/DC
Max. current	6 mA

Insulation

Insulation voltage	4 kV
Dielectric strength	660 V

Specifications

Ambient temperature storage/operation	-20 ... 80°C / -5 ... 40°C (no ice)
Connection terminals	Screw terminal 10 mm ²
Protection degree	IP 20
Mounting	TS-35 or Back Panel Mounting
Housing material	PPE / Aluminium
Weight	650 g

Product References

Solid State Contactor 1ph.

CC1H230



Connection diagram

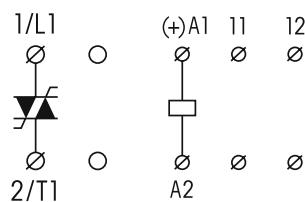

Dimensions

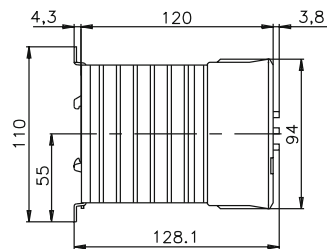
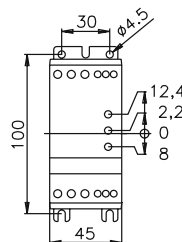

Technical approvals, conformities



IEC/EN 60947-4-3

CC1H250

50 A | Single phase 230 V AC



Output

Switching element	Thyristor
Numbers of phases	1
Nominal voltage (U_{nom})	230 V AC
Output voltage range	12 – 240 V AC
Frequency	50/60 Hz
Reverse voltage	1000 V _{rrm}
Peak reverse voltage	1100 V _{rsm}
Min. load	10 mA
Max. leakage current	1 mA
Operation current AC-1/51 @ U_{nom}	50 A
Operation current AC-3 @ U_{nom}	15 A
Operation current AC-55b @ U_{nom}	20 A
Operation current AC-56a @ U_{nom}	15 A
Response/Release time	20 ms
Limit load	1800 A ² s

Input

Voltage	24 – 230 V AC/DC
Min. voltage	20.4 V AC/DC
Max. voltage	253 V AC/DC
Release voltage	7.2 V AC/DC
Max. current	6 mA

Insulation

Insulation voltage	4 kV
Dielectric strength	660 V

Specifications

Ambient temperature storage/operation	-20 ... 80°C / -5 ... 40°C (no ice)
Connection terminals	Screw terminal 10 mm ²
Protection degree	IP 20
Mounting	TS-35 or Back Panel Mounting
Housing material	PPE / Aluminium
Weight	1050 g

Product References

Solid State Contactor 1ph.

CC1H250



Connection diagram

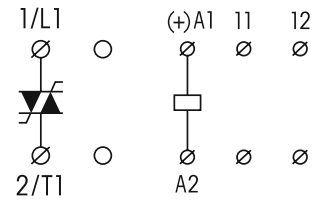

Dimensions

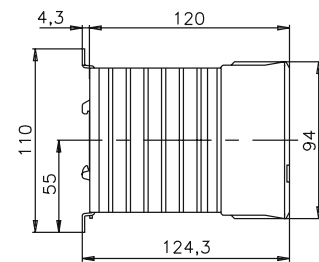
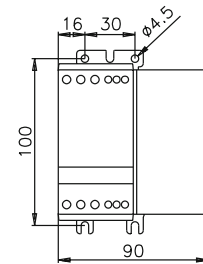

Technical approvals, conformities



CC1H415

15 A | Single phase 400 V AC



Output

Switching element	Thyristor
Numbers of phases	1
Nominal voltage (U _{nom})	400 V AC
Output voltage range	24 – 480 V AC
Frequency	50/60 Hz
Reverse voltage	1200 V _{rrm}
Peak reverse voltage	1300 V _{rsm}
Min. load	10 mA
Max. leakage current	1 mA
Operation current AC-1/51 @ U _{nom}	15 A
Operation current AC-3 @ U _{nom}	15 A
Operation current AC-55b @ U _{nom}	15 A
Operation current AC-56a @ U _{nom}	15 A
Response/Release time	20 ms
Limit load	1800 A ² s

Input

Voltage	24 – 230 V AC/DC
Min. voltage	20.4 V AC/DC
Max. voltage	253 V AC/DC
Release voltage	7.2 V AC/DC
Max. current	6 mA

Insulation

Insulation voltage	4 kV
Dielectric strength	660 V

Specifications

Ambient temperature storage/operation	-20 ... 80°C / -5 ... 40°C (no ice)
Connection terminals	Screw terminal 6 mm ²
Protection degree	IP 20
Mounting	TS-35 or Back Panel Mounting
Housing material	PPE / Aluminium
Weight	270 g

Product References

Solid State Contactor 1ph.

CC1H415



Connection diagram

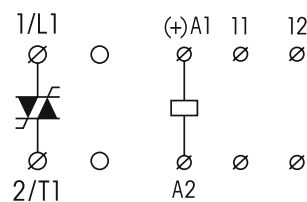

Dimensions

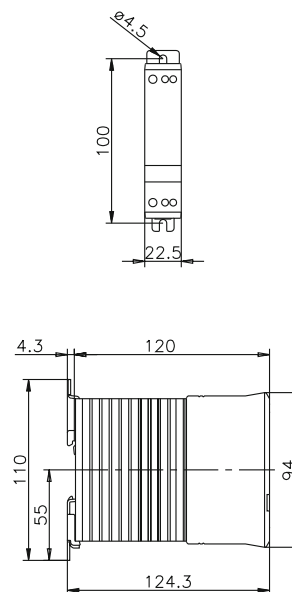

Technical approvals, conformities



IEC/EN 60947-4-3

CC1H430

30A | Single phase 400 V AC



Output

Switching element	Thyristor
Numbers of phases	1
Nominal voltage (U_{nom})	400 V AC
Output voltage range	24 – 480 V AC
Frequency	50/60 Hz
Reverse voltage	1200 V _{rrm}
Peak reverse voltage	1300 V _{rsm}
Min. load	10 mA
Max. leakage current	1 mA
Operation current AC-1/51 @ U_{nom}	30 A
Operation current AC-3 @ U_{nom}	15 A
Operation current AC-55b @ U_{nom}	20 A
Operation current AC-56a @ U_{nom}	15 A
Response/Release time	20 ms
Limit load	1800 A ² s

Input

Voltage	24 – 230 V AC/DC
Min. voltage	20.4 V AC/DC
Max. voltage	253 V AC/DC
Release voltage	7.2 V AC/DC
Max. current	6 mA

Insulation

Insulation voltage	4 kV
Dielectric strength	660 V

Specifications

Ambient temperature storage/operation	-20 ... 80°C / -5 ... 40°C (no ice)
Connection terminals	Screw terminal 6 mm ²
Protection degree	IP 20
Mounting	TS-35 or Back Panel Mounting
Housing material	PPE / Aluminium
Weight	650 g

Product References

Solid State Contactor 1ph.

CC1H430



Connection diagram

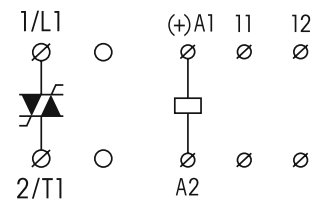

Dimensions

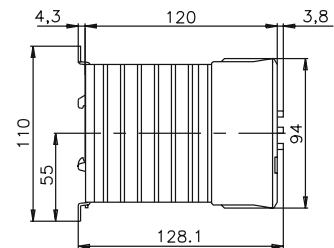
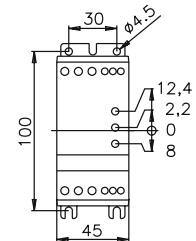

Technical approvals, conformities



CC1H450

50 A | Single phase 400 V AC



Output

Switching element	Thyristor
Numbers of phases	1
Nominal voltage (U _{nom})	400 V AC
Output voltage range	24 – 480 V AC
Frequency	50/60 Hz
Reverse voltage	1200 V _{rrm}
Peak reverse voltage	1300 V _{rsm}
Min. load	10 mA
Max. leakage current	1 mA
Operation current AC-1/51 @ U _{nom}	50 A
Operation current AC-3 @ U _{nom}	15 A
Operation current AC-55b @ U _{nom}	20 A
Operation current AC-56a @ U _{nom}	15 A
Response/Release time	20 ms
Limit load	1800 A ² s

Input

Voltage	24 – 230 V AC/DC
Min. voltage	20.4 V AC/DC
Max. voltage	253 V AC/DC
Release voltage	7.2 V AC/DC
Max. current	6 mA

Insulation

Insulation voltage	4 kV
Dielectric strength	660 V

Specifications

Ambient temperature storage/operation	-20 ... 80°C / -5 ... 40°C (no ice)
Connection terminals	Screw terminal 10 mm ²
Protection degree	IP 20
Mounting	TS-35 or Back Panel Mounting
Housing material	PPE / Aluminium
Weight	1050 g

Product References

Solid State Contactor 1ph.

CC1H450



Connection diagram

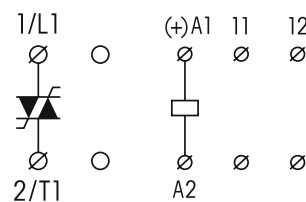

Dimensions

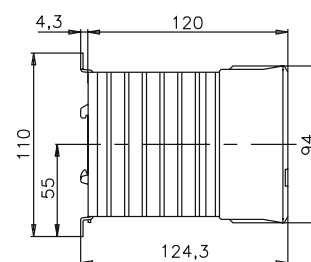
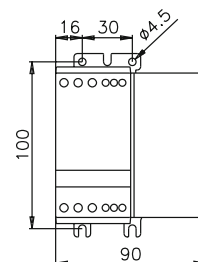

Technical approvals, conformities



CC3H410

10A | Triple phase 400 V AC



Output

Switching element	Thyristor
Numbers of phases	3
Nominal voltage (U_{nom})	400 V AC
Output voltage range	24 – 480 V AC
Frequency	50/60 Hz
Reverse voltage	1200 V _{rrm}
Peak reverse voltage	1300 V _{rsm}
Min. load	10 mA
Max. leakage current	1 mA
Operation current AC-1/51 @ U_{nom}	10 A
Operation current AC-3 @ U_{nom}	10 A
Operation current AC-55b @ U_{nom}	10 A
Operation current AC-56a @ U_{nom}	5 A
Response/Release time	20 ms
Limit load	610 A ² s

Input

Voltage	24 – 230 V AC/DC
Min. voltage	20.4 V AC/DC
Max. voltage	253 V AC/DC
Release voltage	7.2 V AC/DC
Max. current	6 mA

Insulation

Insulation voltage	4 kV
Dielectric strength	660 V

Specifications

Ambient temperature storage/operation	-20 ... 80°C / -5 ... 40°C (no ice)
Connection terminals	Screw terminal 6 mm ²
Protection degree	IP 20
Mounting	TS-35 or Back Panel Mounting
Housing material	PPE / Aluminium
Weight	650 g

Product References

Solid State Contactor 3ph.

CC3H410



Connection diagram

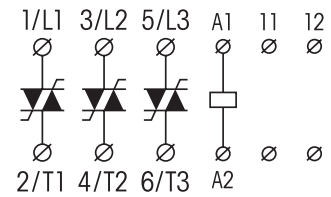

Dimensions

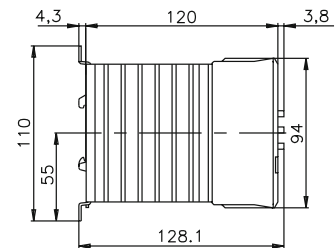
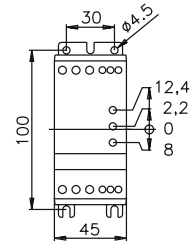

Technical approvals, conformities



IEC/EN 60947-4-3

CC3H420

20 A | Triple phase 400 V AC



Output

Switching element	Thyristor
Numbers of phases	3
Nominal voltage (U _{nom})	400 V AC
Output voltage range	24 – 480 V AC
Frequency	50/60 Hz
Reverse voltage	1200 V _{rrm}
Peak reverse voltage	1300 V _{rsm}
Min. load	10 mA
Max. leakage current	1 mA
Operation current AC-1/51 @ U _{nom}	20 A
Operation current AC-3 @ U _{nom}	10 A
Operation current AC-55b @ U _{nom}	10 A
Operation current AC-56a @ U _{nom}	5 A
Response/Release time	20 ms
Limit load	610 A ² s

Input

Voltage	24 – 230 V AC/DC
Min. voltage	20.4 V AC/DC
Max. voltage	253 V AC/DC
Release voltage	7.2 V AC/DC
Max. current	6 mA

Insulation

Insulation voltage	4 kV
Dielectric strength	660 V

Specifications

Ambient temperature storage/operation	-20 ... 80°C / -5 ... 40°C (no ice)
Connection terminals	Screw terminal 10 mm ²
Protection degree	IP 20
Mounting	TS-35 or Back Panel Mounting
Housing material	PPE / Aluminium
Weight	1050 g

Product References

Solid State Contactor 3ph.

CC3H420



Connection diagram

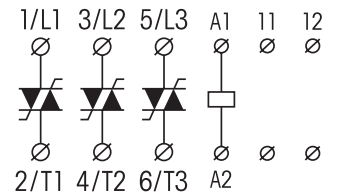

Dimensions

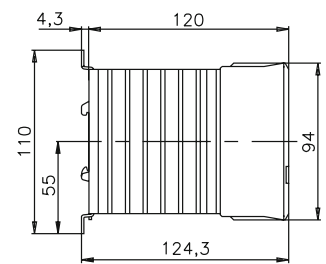
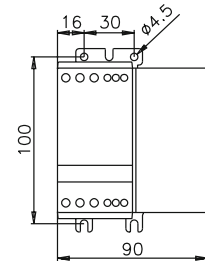

Technical approvals, conformities



IEC/EN 60947-4-3

CCR3H410

10A | Three phase reversing contactor 400 V AC



Output

Switching element	Thyristor
Numbers of phases	3
Nominal voltage (U_{nom})	400 V AC
Output voltage range	24 – 480 V AC
Frequency	50/60 Hz
Reverse voltage	1200 V _{rrm}
Peak reverse voltage	1300 V _{rsm}
Min. load	50 mA
Max. leakage current	5 mA
Operation current AC-1/51 @ U_{nom}	10 A
Operation current AC-53 @ U_{nom}	10 A
Response/Release time	20 ms
Limit load	610 A ² s

Input

Voltage	24 – 230 V AC/DC
---------	------------------

Insulation

Insulation voltage	4 kV
Dielectric strength	660 V

Specifications

Ambient temperature storage/operation	-20 ... 80°C / -5 ... 40°C (no ice)
Connection terminals	Screw terminal 2.5 mm ²
Protection degree	IP 20
Mounting	TS-35 or Back Panel Mounting
Housing material	PPE / Aluminium
Weight	650 g

Product References

Reversing contactor

CCR3H410



Dimensions

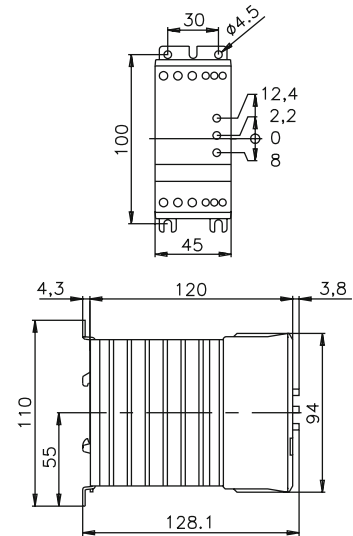

Connection diagram

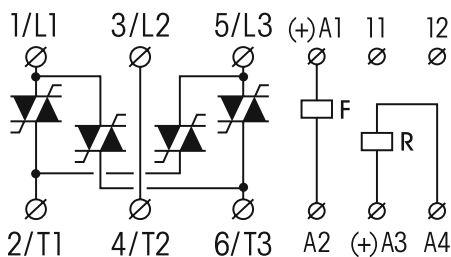

Technical approvals, conformities



IEC/EN 60947-4-2

CPC1230

30 A | Single phase 400 V AC



Output

Switching element	Thyristor
Numbers of phases	1
Nominal voltage (U_{nom})	230 V AC
Output voltage range	208 – 240 V AC
Frequency	50/60 Hz
Reverse voltage	1000 V _{rrm}
Peak reverse voltage	1100 V _{rsm}
Min. load	10 mA
Max. leakage current	1 mA
Operation current AC-1/51 @ U_{nom}	30 A
Operation current AC-3 @ U_{nom}	15 (non uL)
Operation current AC-55b @ U_{nom}	30 A
Operation current AC-56a @ U_{nom}	30 A
Response/Release time	20 ms
Limit load	1800 A ² s

Input

Voltage	24 V AC/DC
Control signal	0 – 10 V, 10 – 0 V
	0 – 20 mA, 20 – 0 mA
	4 – 20 mA, 20 – 4 mA
Potentiometer	0 – 10 k Ω , 10 – 0 k Ω

Insulation

Insulation voltage	4 kV
Dielectric strength	660 V

Specifications

Ambient temperature storage/operation	-20 ... 80°C / -5 ... 40°C (no ice)
Connection terminals	Screw terminal 2.5 mm ²
Protection degree	IP 20
Mounting	TS-35 or Back Panel Mounting
Housing material	PPE / Aluminium
Weight	650 g

Product References

Performance Regulator

CPC1230



Dimensions

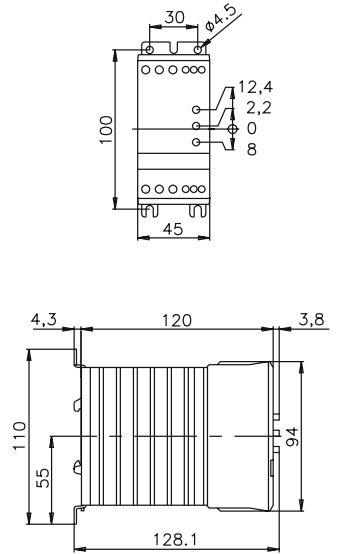

Connection diagram

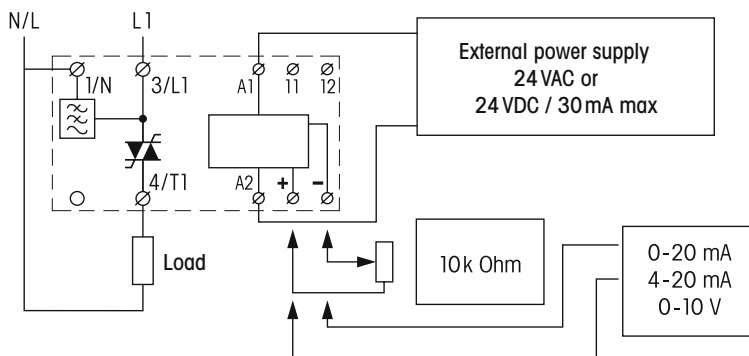

Technical approvals, conformities



IEC/EN 60947-4-3

CPC1250

50 A | Single phase 230 V AC



Output

Switching element	Thyristor
Numbers of phases	1
Nominal voltage (U _{nom})	230 V AC
Output voltage range	208 – 240 V AC
Frequency	50/60 Hz
Reverse voltage	1000 V _{rrm}
Peak reverse voltage	1100 V _{rsm}
Min. load	10 mA
Max. leakage current	1 mA
Operation current AC-1/51 @ U _{nom}	50 A
Operation current AC-3 @ U _{nom}	15 (non uL)
Operation current AC-55b @ U _{nom}	30 A
Operation current AC-56a @ U _{nom}	30 A
Response/Release time	20 ms
Limit load	1800 A ² s

Input

Voltage	24 V AC/DC
Control signal	0 – 10 V, 10 – 0 V 0 – 20 mA, 20 – 0 mA 4 – 20 mA, 20 – 4 mA
Potentiometer	0 – 10 kΩ, 10 – 0 kΩ

Insulation

Insulation voltage	4 kV
Dielectric strength	660 V

Specifications

Ambient temperature storage/operation	-20 ... 80°C / -5 ... 40°C (no ice)
Connection terminals	Screw terminal 2.5 mm ²
Protection degree	IP 20
Mounting	TS-35 or Back Panel Mounting
Housing material	PPE / Aluminium
Weight	650 g

Product References

Performance Regulator

CPC1250



Dimensions

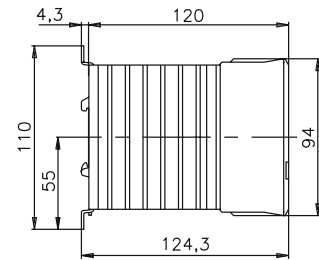
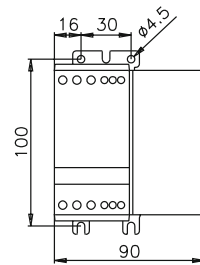

Connection diagram

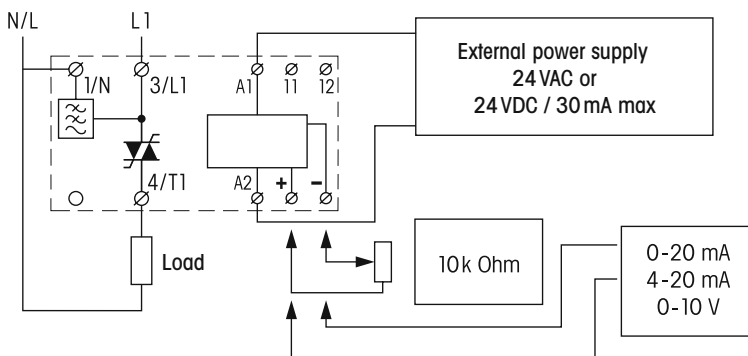

Technical approvals, conformities



IEC/EN 60947-4-3

CPC1430

30 A | Single phase 400 V AC



Output

Switching element	Thyristor
Numbers of phases	1
Nominal voltage (U_{nom})	400 V AC
Output voltage range	380 – 480 V AC
Frequency	50/60 Hz
Reverse voltage	1200 V _{rrm}
Peak reverse voltage	1300 V _{rsm}
Min. load	10 mA
Max. leakage current	1 mA
Operation current AC-1/51 @ U_{nom}	30 A
Operation current AC-3 @ U_{nom}	15 (non uL)
Operation current AC-55b @ U_{nom}	30 A
Operation current AC-56a @ U_{nom}	30 A
Response/Release time	20 ms
Limit load	1800 A ² s

Input

Voltage	24 V AC/DC
Control signal	0 – 10 V, 10 – 0 V 0 – 20 mA, 20 – 0 mA 4 – 20 mA, 20 – 4 mA
Potentiometer	0 – 10 k Ω , 10 – 0 k Ω

Insulation

Insulation voltage	4 kV
Dielectric strength	660 V

Specifications

Ambient temperature storage/operation	-20 ... 80°C / -5 ... 40°C (no ice)
Connection terminals	Screw terminal 2.5 mm ²
Protection degree	IP 20
Mounting	TS-35 or Back Panel Mounting
Housing material	PPE / Aluminium
Weight	650 g

Product References

Performance Regulator

CPC1430



Dimensions

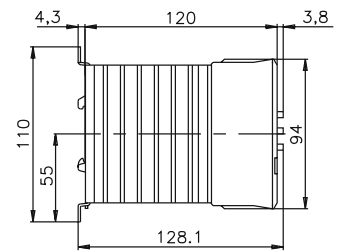
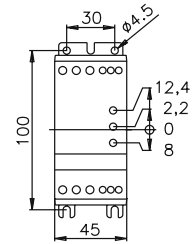

Connection diagram

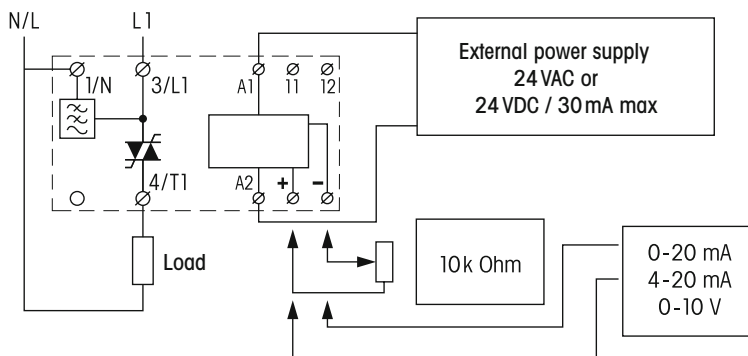

Technical approvals, conformities



IEC/EN 60947-4-3

CPC1450

50 A | Single phase 400 V AC



Output

Switching element	Thyristor
Numbers of phases	1
Nominal voltage (U_{nom})	400 V AC
Output voltage range	380 – 480 V AC
Frequency	50/60 Hz
Reverse voltage	1200 V _{rrm}
Peak reverse voltage	1300 V _{rsm}
Min. load	10 mA
Max. leakage current	1 mA
Operation current AC-1/51 @ U_{nom}	50 A
Operation current AC-3 @ U_{nom}	15 (non uL)
Operation current AC-55b @ U_{nom}	30 A
Operation current AC-56a @ U_{nom}	30 A
Response/Release time	20 ms
Limit load	1800 A ² s

Input

Voltage	24 V AC/DC
Control signal	0 – 10 V, 10 – 0 V 0 – 20 mA, 20 – 0 mA 4 – 20 mA, 20 – 4 mA
Potentiometer	0 – 10 kΩ, 10 – 0 kΩ

Insulation

Insulation voltage	4 kV
Dielectric strength	660 V

Specifications

Ambient temperature storage/operation	-20 ... 80°C / -5 ... 40°C (no ice)
Connection terminals	Screw terminal 2.5 mm ²
Protection degree	IP 20
Mounting	TS-35 or Back Panel Mounting
Housing material	PPE / Aluminium
Weight	1050 g

Product References

Performance Regulator

CPC1450



Dimensions

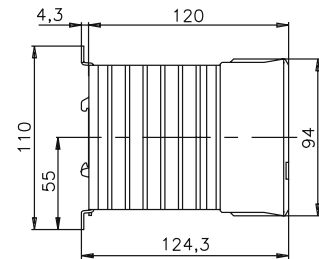
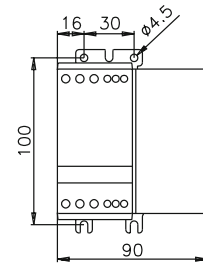

Connection diagram

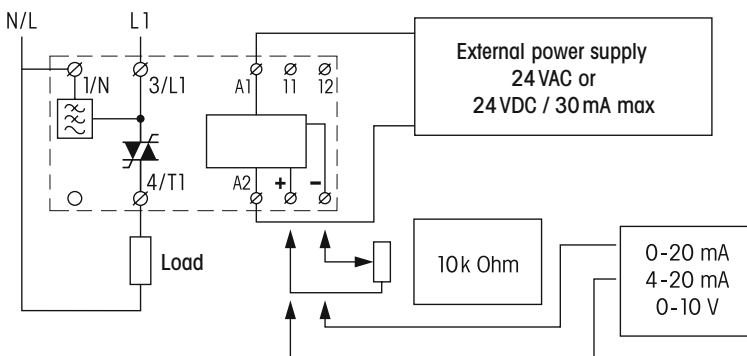

Technical approvals, conformities



IEC/EN 60947-4-3

2.0 Time Relays

Delay functions

E On delay

S ⇒ R on with delay
S_{OFF} ⇒ R off

A Off delay

S ⇒ R on
S_{OFF} ⇒ R off with delay

F On and off delay

S ⇒ R on with delay (t₁)
S_{OFF} ⇒ R off with delay (t₂)

Shot timing modes

W One shot leading edge

S ⇒ R on for t
S_{OFF} ⇒ R off (pulse clipping)

N One shot trailing edge

S_{OFF} ⇒ R on for t
S on for t ⇒ R off

Q One shot leading and trailing edge

S ⇒ R on for t₁
S_{OFF} ⇒ R on for t₂
S_{OFF} off for t₁ ⇒ R off

Puls shaping

K Puls shaping

S (pulse or continuous contact) ⇒ R on for t
S... no influence on R and t

L Pulse shaping, retrigger (subsequ.time operation from 0)

S (pulse or continuous contact) ⇒ R on for t
S on for t = t_{RESET}

M Puls shaping

S_{OFF} ⇒ R on for t
S... no influence on R and t

Blinker functions

B Blinker, pulse start

S ⇒ R on/off periodically according to t
S_{OFF} ⇒ R off

B₁ Blinker, pulse start, trailing pulse

S ⇒ R on/off periodically according to t
S_{OFF}: last pulse = t

B₂ Blinker, interval start

S ⇒ R after t on/off periodically according to t
S_{OFF} ⇒ R off

Delayed pulse

G On delay single shot

S (pulse or continuous contact) ⇒ R after t₁ on for t₂
S... no influence on R and t

H On delay single shot

S ⇒ R after t₁ on for t₂
S_{OFF} ⇒ R off

Repeat cycle timer

I Repeat cycle timer, pulse start

S ⇒ R on/off periodically according to t₁ and t₂
S_{OFF} ⇒ R off

P Repeat cycle timer, interval start C55, CT1: $\frac{t_2}{t_1}$

S ⇒ R after t₁ (t₂) on/off periodically according to t₂ and t₁
S_{OFF} ⇒ R off

Special functions

Y Star-delta timer

S ⇒ Δ on for t
Δ_{OFF} ⇒ Δ on with delay for t
S_{OFF} ⇒ Δ off

X₁ Restart delay

S ⇒ R on
S_{OFF} ⇒ R off and starts t
S ⇒ R restart only after t

Special functions

S Step-on/Step-off switch

S ⇒ R on/off

LS Step-switching (staircase lighting timer), with time lapse

S ⇒ R on and starts t
S on for t ⇒ R off

Stop/Reset

t_{STOP} S_{STOP} interrupts t (t-addition) **T** t is stopped ⇒ R on/off

t_{RESET} S_{RESET} reset t t restarts immediately **T** Test

S = Triggering
R = Output circuit
⇒ = switches...

Pulse sequence monitoring

U

S1/S2
P (tp)
R

V

S1/S2
P (tp)
R

S1/S2 = Monitoring start
P = Pulse sequence
tp = Pulse separation

≤: Pulse separation is **smaller** than the time tp
>: Pulse separation is **larger** than the time tp

Start with S1 = **without** start-up short-out t_A
Start with S2 = **start-up** short-out t_A

t_v = settable alarm delay
delay (t_A = t_v)

2.1 ON and OFF delay Relays

Application	Types	Contacts	AC ratings	DC ratings
CMD Series				
ON or OFF delay 12 V AC / DC supply	CMD11-A/UC12V, CMD11-E/UC12V	1 CO	8 A / 250 V	8 A / 30 V
ON or OFF delay 24 V AC / DC supply	CMD11-A/UC24V, CMD11-E/UC24V	1 CO	8 A / 250 V	8 A / 30 V
ON or OFF delay 115 V AC supply	CMD11-A/AC115V, CMD11-E/AC115V	1 CO	8 A / 250 V	8 A / 30 V
ON or OFF delay 230 V AC supply	CMD11-A/AC230V, CMD11-E/AC230V	1 CO	8 A / 250 V	8 A / 30 V



Maximum contact load	8 A 250 V AC-1	8 A 30 V DC-1
Recommended minimum contact load	100 mA / 12 V	

Time functions and related connection diagrams (Function diagrams: refer to page 148)

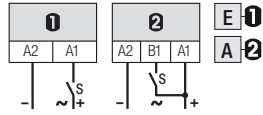

Time data

5 partial time ranges, t_{max} (DIP switch)	0.6 s / 6 s / 60 s / 6 min / 60 min
Fine adjustment range (rotary knob)	$t_{min} \dots t_{max}$, 0.5 ... 6
Time range tolerance	t_{min} : -30 % ... +0 % / t_{max} : -0 % ... +30 %
Repetition accuracy	± 0.2 % or 20 ms
Response time, power on, on A1	≤ 50 ms
Min. trigger pulse width on input B1	100 ms (AC / DC)
Reset time B1 (AC/DC)	≤ 90 ms
Voltage failure buffering	≥ 5 ms

Contacts

Type	Single contact, CO
Material	AgNi
Rated operational current	10 A
Max. inrush current (10ms)	15 A
Max. switching voltage AC-1	250 V
Max. AC load AC-1 (Fig. 1)	2500 VA AC-1
Max. DC load DC-1 24 V / 220 V (Fig. 2)	150 W / 70 W

Power supply- and control input

CMD11-.../UC12V	
Nominal voltage (UC = AC / DC)	12 V AC/DC
Operating voltage range	9.6 ... 14.4 V AC/DC
Power consumption DC typ.	32 mA
Power consumption AC typ.	50 mA
Frequency range	48 ... 62 Hz
Input current into B1 typ. AC/DC	2.7 / 4.3 mA
Trigger threshold voltage on B1 typ AC / DC	5.2 / 8.8 V

Insulation

Test voltage open contact	1 kV rms / 1 min
Test voltage between contacts and control input	2 kV rms / 1 min

Specifications

Ambient temperature storage /operation	-40 ... 85 °C / -40 ...60 °C (no ice)
Life time of contacts 8 A, 250 V AC-1	75×10^3
Conductor cross section	Stranded wire 2.5 mm ² , 2 x 1.5 mm ²
Protection degree	IP 20
Nominal screw torque	0.5 Nm
Housing material / Weight	Polyamide PA-66 (UL94-V0) / 48 g
Mounting	TS-35 or Back Panel Mounting

Product References

Monofunction Time Relay (Off delay)
Monofunction Time Relay (On delay)

CMD11-A/UC12V
CMD11-E/UC12V



Connection diagram

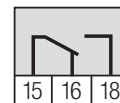

Fig.1 AC voltage endurance

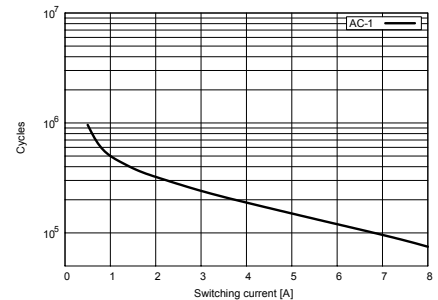
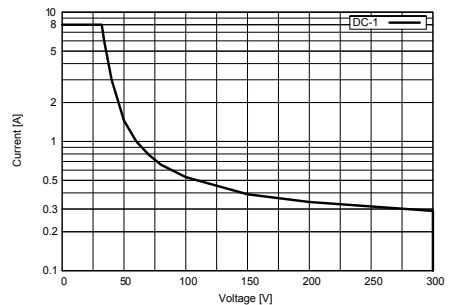
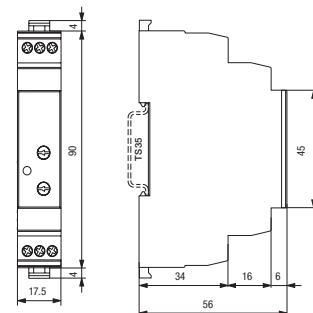

Fig. 2 DC load limit curve



Dimensions



Technical approvals, conformities



IEC/EN 60947

CMD11-A/UC24V, CMD11-E/UC24V

1 CO contact | ON or OFF delay | 24 V AC / DC supply



Maximum contact load	8 A 250 V AC-1	8 A 30 V DC-1
Recommended minimum contact load	100 mA / 12 V	

Time functions and related connection diagrams (Function diagrams: refer to page 148)

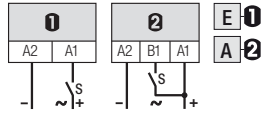

Time data

5 partial time ranges, t_{max} (DIP switch)	0.6 s / 6 s / 60 s / 6 min / 60 min
Fine adjustment range (rotary knob)	$t_{min} \dots t_{max}$, 0.5 ... 6
Time range tolerance	t_{min} : -30 % ... +0 % / t_{max} : -0 % ... +30 %
Repetition accuracy	± 0.2 % or 20 ms
Response time, power on, on A1	≤ 50 ms
Min. trigger pulse width on input B1	100 ms (AC / DC)
Reset time B1 (AC/DC)	≤ 90 ms
Voltage failure buffering	≥ 5 ms

Contacts

Type	Single contact, CO
Material	AgNi
Rated operational current	10 A
Max. inrush current (10ms)	15 A
Max. switching voltage AC-1	250 V
Max. AC load AC-1 (Fig. 1)	2500 VA AC-1
Max. DC load DC-1 24 V / 220 V (Fig. 2)	150 W / 70 W

Power supply- and control input

CMD11-.../UC24V	
Nominal voltage (UC = AC / DC)	24 V AC/DC
Operating voltage range	19.2 ... 28.8 V AC/DC
Power consumption DC typ.	12 mA
Power consumption AC typ.	21 mA
Frequency range	48 ... 62 Hz
Input current into B1 typ. AC / DC	11.6. / 9.5 mA
Trigger threshold voltage on B1 typ AC / DC	9.5 / 14 V

Insulation

Test voltage open contact	1 kV rms / 1 min
Test voltage between contacts and control input	2 kV rms / 1 min

Specifications

Ambient temperature storage /operation	-40 ... 85 °C / -40 ... 60 °C (no ice)
Life time of contacts 8 A, 250 V AC-1	75 x 10 ³
Conductor cross section	Stranded wire 2.5 mm ² , 2 x 1.5 mm ²
Protection degree	IP 20
Nominal screw torque	0.5 Nm
Housing material / Weight	Polyamide PA-66 (UL94-V0) / 48 g
Mounting	TS-35 or Back Panel Mounting

Product References

Monofunction Time Relay (Off delay)
Monofunction Time Relay (On delay)

CMD11-A/UC24V
CMD11-E/UC24V



Connection diagram

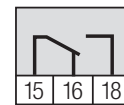

Fig.1 AC voltage endurance

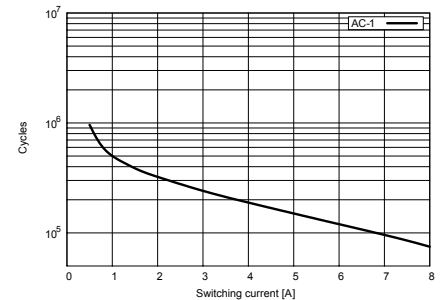
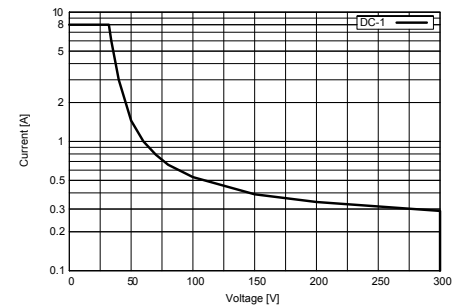
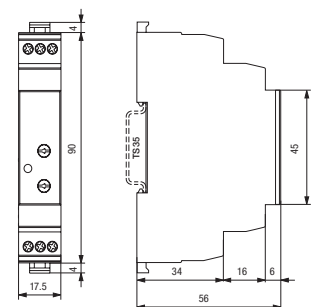

Fig. 2 DC load limit curve



Dimensions



Technical approvals, conformities



IEC/EN 60947



Maximum contact load	8 A 250 V AC-1	8 A 30 V DC-1
Recommended minimum contact load	100 mA / 12 V	

Time functions and related connection diagrams (Function diagrams: refer to page 148)

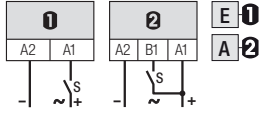

Time data

5 partial time ranges, t_{max} (DIP switch)	0.6 s / 6 s / 60 s / 6 min / 60 min
Fine adjustment range (rotary knob)	$t_{min} \dots t_{max}$, 0.5 ... 6
Time range tolerance	t_{min} : -30 % ... +0 % / t_{max} : -0 % ... +30 %
Repetition accuracy	± 0.2 % or 20 ms
Response time, power on, on A1	≤ 50 ms
Min. trigger pulse width on input B1	100 ms (AC / DC)
Reset time B1 (AC/DC)	≤ 90 ms
Voltage failure buffering	≥ 5 ms

Contacts

Type	Single contact, CO
Material	AgNi
Rated operational current	10 A
Max. inrush current (10ms)	15 A
Max. switching voltage AC-1	250 V
Max. AC load AC-1 (Fig. 1)	2500 VA AC-1
Max. DC load DC-1 24 V / 220 V (Fig. 2)	150 W / 70 W

Power supply- and control input

CMD11-.../AC115V	
Nominal voltage	115 V AC
Operating voltage range	92 ... 138 V AC
Power consumption AC typ.	47 mA
Frequency range	48 ... 62 Hz
Input current into B1 typ. AC	1.7 mA
Trigger threshold voltage on B1 typ AC	42 V

Insulation

Test voltage open contact	1 kV rms / 1 min
Test voltage between contacts and control input	2 kV rms / 1 min

Specifications

Ambient temperature storage /operation	-40 ... 85 °C / -40 ...60 °C (no ice)
Life time of contacts 8 A, 250 V AC-1	75×10^3
Conductor cross section	Stranded wire 2.5 mm ² , 2 x 1.5 mm ²
Protection degree	IP 20
Nominal screw torque	0.5 Nm
Housing material / Weight	Polyamide PA-66 (UL94-V0) / 48 g
Mounting	TS-35 or Back Panel Mounting

Product References

Monofunction Time Relay (Off delay)	CMD11-A/AC115V
Monofunction Time Relay (On delay)	CMD11-E/AC115V



Connection diagram

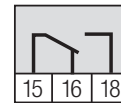

Fig.1 AC voltage endurance

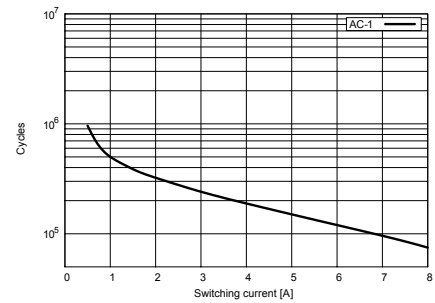
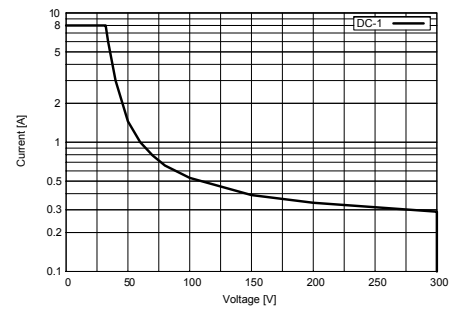
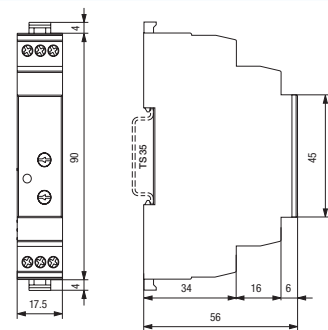

Fig. 2 DC load limit curve



Dimensions



Technical approvals, conformities



IEC/EN 60947

CMD11-A/AC230V, CMD11-E/AC230V

1 CO contact | ON or OFF delay | 230 V AC / DC supply



Maximum contact load	8 A 250 V AC-1	8 A 30 V DC-1
Recommended minimum contact load	100 mA / 12 V	

Time functions and related connection diagrams (Function diagrams: refer to page 148)

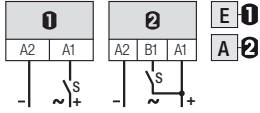

Time data

5 partial time ranges, t_{max} (DIP switch)	0.6 s / 6 s / 60 s / 6 min / 60 min
Fine adjustment range (rotary knob)	$t_{min} \dots t_{max}$, 0.5 ... 6
Time range tolerance	t_{min} : -30 % ... +0 % / t_{max} : -0 % ... +30 %
Repetition accuracy	± 0.2 % or 20 ms
Response time, power on, on A1	≤ 50 ms
Min. trigger pulse width on input B1	100 ms (AC / DC)
Reset time B1 (AC/DC)	≤ 90 ms
Voltage failure buffering	≥ 5 ms

Contacts

Type	Single contact, CO
Material	AgNi
Rated operational current	10 A
Max. inrush current (10ms)	15 A
Max. switching voltage AC-1	250 V
Max. AC load AC-1 (Fig. 1)	2500 VA AC-1
Max. DC load DC-1 24 V / 220 V (Fig. 2)	150 W / 70 W

Power supply- and control input

CMD11-.../AC230V	
Nominal voltage	230 V AC
Operating voltage range	184 ... 255 V AC
Power consumption AC typ.	60 mA
Frequency range	48 ... 62 Hz
Input current into B1 typ. AC	1.9 mA
Trigger threshold voltage on B1 typ AC	80 V

Insulation

Test voltage open contact	1 kV rms / 1 min
Test voltage between contacts and control input	2 kV rms / 1 min

Specifications

Ambient temperature storage /operation	-40 ... 85 °C / -40 ...60 °C (no ice)
Life time of contacts 8 A, 250 V AC-1	75 x 10 ³
Conductor cross section	Stranded wire 2.5 mm ² , 2 x 1.5 mm ²
Protection degree	IP 20
Nominal screw torque	0.5 Nm
Housing material / Weight	Polyamide PA-66 (UL94-V0) / 48 g
Mounting	TS-35 or Back Panel Mounting

Product References

Monofunction Time Relay (Off delay)
Monofunction Time Relay (On delay)

CMD11-A/AC230V
CMD11-E/AC230V



Connection diagram

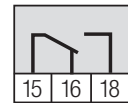

Fig.1 AC voltage endurance

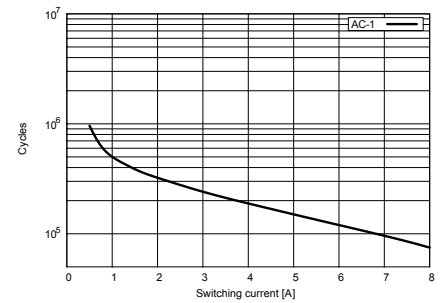
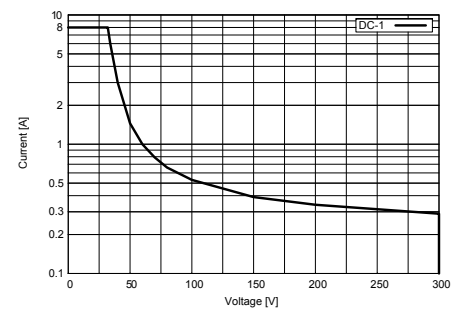
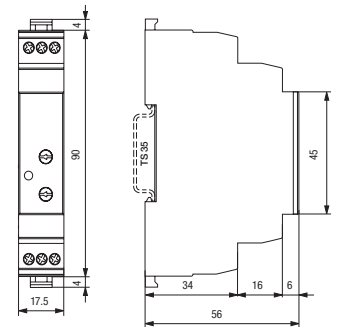

Fig. 2 DC load limit curve



Dimensions



Technical approvals, conformities



IEC/EN 60947

2.2 Multifunction Time Relays

Application	Types	Contacts	AC ratings	DC ratings
CIM Series				
Multifunction 24-240 V AC / DC	CIM1, CIM1R	1 CO	16 A / 250 V	16 A / 24 V
Multifunction 24-240 V AC / DC	CIM12, CIM12R	1 Triac	2 A / 250 V	-
Multifunction 24-240 V AC / DC	CIM13, CIM13R	1 Mosfet	-	4 A / 30 V
Multifunction 24-240 V AC / DC	CIM14	1 NO	16 A / 250 V	16 A / 24 V
Multifunction 24-240 V AC / DC	CIM2, CIM2R	1 CO	16 A / 250 V	16 A / 24 V
Multifunction 24-240 V AC / DC	CIM22, CIM22R	1 Triac	2 A / 250 V	-
Multifunction 24-240 V AC / DC	CIM23, CIM23R	1 Mosfet	-	4 A / 30 V
Multifunction 24-240 V AC / DC	CIM3, CIM3R	1 CO	16 A / 250 V	16 A / 24 V
Multifunction 24-240 V AC / DC	CIM32, CIM32R	1 Triac	2 A / 250 V	-
Multifunction 24-240 V AC / DC	CIM33, CIM33R	1 Mosfet	-	4 A / 30 V

CIM1, CIM1R

Multifunction | 24-240 V AC / DC



Maximum contact load	16 A / 250 V AC-1 16 A / 24 V DC-1
Recommended minimum contact load	10 mA / 10 V

Time functions and related connection diagrams (Function diagrams: refer to page 148)
The functions are selectable by rotary switch

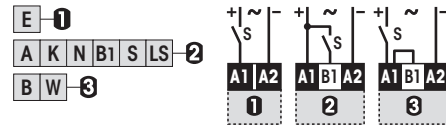

LED function table:

LED	Relay	Time run
OFF	OFF	NO
Continuous ON	ON	NO
Short blinking	OFF	YES
Long blinking	ON	YES

Time data

7 partial time ranges, t_{max} (rotary switch)	0.6, 6, 60 s / 6, 60 min / 6, 60 h
Fine adjustment range (rotary knob)	$t_{min} \dots t_{max}$, 0.5 ... 6
Time range tolerance	t_{min} : -5 % ... +0 % / t_{max} : -0 % ... +5 %
Repetition accuracy	± 0.1 % or DC: 2 ms / AC: 10 ms
Response time, power on, on A1	≤ 45 ms
Min. trigger pulse on B1	20 ms (AC / DC)
Reset time B1 (AC/DC)	≤ 30 ms
Voltage failure buffering (50 / 60 Hz)	≥ 20 ms

Contacts

Material CIM1 / CIM1R / Type	AgNi / 1 CO, micro disconnection, zero crossing
Rated operational current at 40 °C / 60 °C	16 A / 13 A
Max. inrush current	30 A
Max. switching voltage AC-1	250 V
Max. AC load AC-1 (Fig.1)	4 kVA
Max. DC load DC-1 30 V / 250 V (Fig.2)	240 W / 85 W

Power supply- and control input

Nominal voltage (A1, B1)	UC 24-240 V (UC = AC / DC)
Operating voltage range	UC 19 ... 250 V
Power consumption	approx. 1 W
Frequency range	15 ... 60 Hz
Allowed DC residual current into B1	≤ 0.5 mA
AC Neon lamp residual current into B1	≤ 10 mA
Trigger threshold voltage on B1, AC / DC	15 / 17 V

Insulation

Test voltage open contact	1 kV rms / 1 min
Test voltage between contacts and control input	2.5 kV rms / 1 min

Specifications

Ambient temperature storage /operation	-40 ... 85 °C / -40 ...60 °C (Railway: -46 °C) (no ice)
Mechanical life of contact	30 x 1'000'000 operations
Conductor cross section	Stranded wire 2.5 mm ² , 2 x 1.5 mm ²
Protection degree	IP 20
Nominal screw torque	0.4 Nm
Housing material / weight	Lexan / 70 g
Mounting	TS-35 or Back Panel Mounting

Product References

Standard	CIM1/UC24-240V
Railway	CIM1R/UC24-240V



Connection diagram

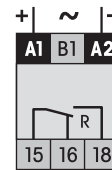

Fig.1 AC voltage endurance

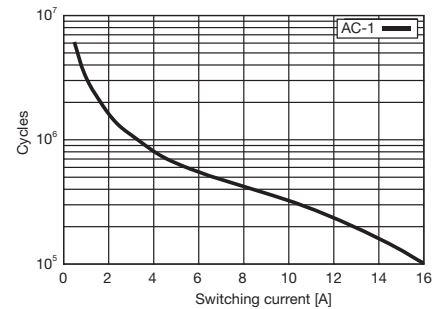
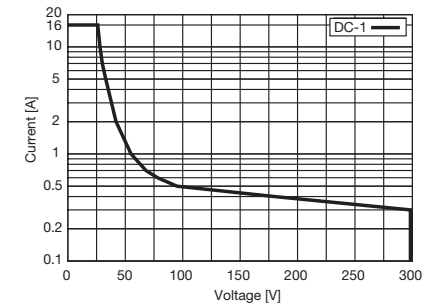
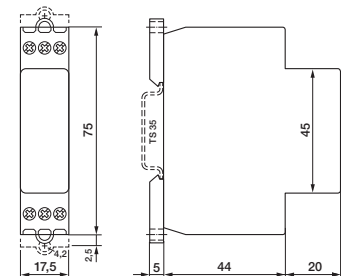

Fig. 2 DC load limit curve



Dimensions



Technical approvals, conformities



IEC/EN 50155, IEC/EN 60730

CIM12, CIM12R

Multifunction | 24-240 V AC / DC



TURCK



Maximum contact load 2 A / 250 V AC-1
Minimum contact load 50 mA

Time functions and related connection diagrams (Function diagrams: refer to page 148)
 The functions are selectable by rotary switch

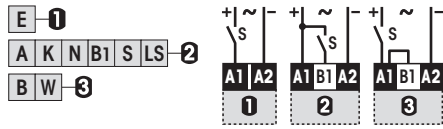

LED function table:

LED	Relay	Time run
OFF	OFF	NO
Continuous ON	ON	NO
Short blinking	OFF	YES
Long blinking	ON	YES

Time data

7 partial time ranges, t_{max} (rotary switch) 0.6, 6, 60 s / 6, 60 min / 6, 60 h
 Fine adjustment range (rotary knob) $t_{min} \dots t_{max}$, 0.5 ... 6
 Time range tolerance t_{min} : -5 % ... +0 % / t_{max} : -0 % ... +5 %
 Repetition accuracy ± 0.1 % or DC: 2 ms / AC: 10 ms
 Response time, power on, on A1 ≤ 45 ms
 Min. trigger pulse on B1 20 ms (AC / DC)
 Reset time B1 (AC/DC) ≤ 30 ms
 Voltage failure buffering (50 / 60 Hz) ≥ 20 ms

Output

Type Triac, zero crossing
 Rated operational current at 40 °C (Fig.1) 2 A
 Max. inrush current (10 ms) 100 A
 Max. switching voltage 250 V
 Max. AC load AC-1 300 VA
 I²t value 78 A²s
 Leakage current < 1 mA

Power supply- and control input

Nominal voltage **UC 24-240 V (UC = AC / DC)**
 Operating voltage range UC 19 ... 250 V
 Power consumption approx. 1 W
 Frequency range 15 ... 60 Hz
 Allowed DC residual current into B1 ≤ 0.5 mA
 AC Neon lamp residual current into B1 ≤ 10 mA
 Trigger threshold voltage on B1, AC / DC 15 / 17 V

Insulation

Test voltage between output and control input 2.5 kV rms / 1 min

Specifications

Ambient temperature storage /operation -40 ... 85 °C / -40 ... 60 °C
 (Railway: -70 °C) (no ice)
 Conductor cross section Stranded wire 2.5 mm², 2 x 1.5 mm²
 Protection degree IP 20
 Nominal screw torque 0.4 Nm
 Housing material / weight Lexan / 70 g
 Mounting TS-35 or Back Panel Mounting

Product References

Standard CIM12/UC24-240V
Railway CIM12R/UC24-240V



Connection diagram

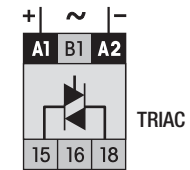
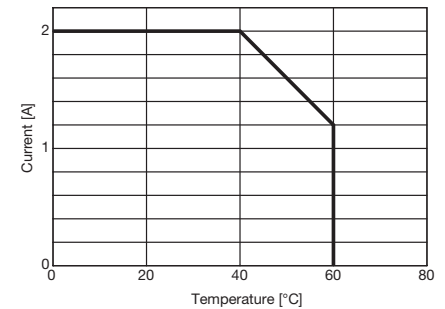
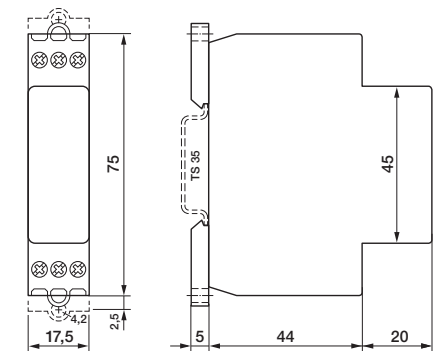

Fig.1 Output derating curve



Dimensions



Technical approvals, conformities





Maximum contact load 4 A / 30 V DC-1
Recommended minimum contact load 1 mA

Time functions and related connection diagrams (Function diagrams: refer to page 148)
 The functions are selectable by rotary switch

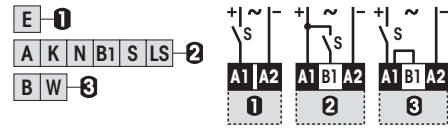

LED function table:

LED	Relay	Time run
OFF	OFF	NO
Continuous ON	ON	NO
Short blinking	OFF	YES
Long blinking	ON	YES

Time data

7 partial time ranges, t_{max} (rotary switch) 0.6, 6, 60 s / 6, 60 min / 6, 60 h
 Fine adjustment range (rotary knob) $t_{min} \dots t_{max}, 0.5 \dots 6$
 Time range tolerance $t_{min}: -5 \% \dots +0 \% / t_{max}: -0 \% \dots +5 \%$
 Repetition accuracy $\pm 0.1 \%$ or DC: 2 ms / AC: 10 ms
 Response time, power on, on A1 ≤ 45 ms
 Min. trigger pulse on B1 20 ms (AC / DC)
 Reset time B1 (AC/DC) ≤ 30 ms
 Voltage failure buffering (50 / 60 Hz) ≥ 20 ms

Output

Type MOS FET
 Rated operational current (Fig. 1) 4 A
 Max. inrush current (10 μ s) 40 A
 Max. switching voltage 30 V
 Leakage current $< 10 \mu$ A

Power supply- and control input

Nominal voltage (UC = AC / DC) **UC 24-240 V (UC = AC / DC)**
 Operating voltage range UC 19 ... 250 V
 Power consumption approx. 1 W
 Frequency range 15 ... 60 Hz
 Allowed DC residual current into B1 ≤ 0.5 mA
 AC Neon lamp residual current into B1 ≤ 10 mA
 Trigger threshold voltage on B1, AC / DC 15 / 17 V

Insulation

Test voltage between output and control input 2.5 kV rms / 1 min

Specifications

Ambient temperature storage /operation $-40 \dots 85 \text{ }^\circ\text{C} / -40 \dots 60 \text{ }^\circ\text{C}$
 (Railway: $-70 \text{ }^\circ\text{C}$) (no ice)
 Conductor cross section Stranded wire 2.5 mm², 2 x 1.5 mm²
 Protection degree IP 20
 Nominal screw torque 0.4 Nm
 Housing material / Weight Lexan / 70 g
 Mounting TS-35 or Back Panel Mounting

Product References

Standard CIM13/UC24-240V
Railway CIM13R/UC24-240V



Connection diagram

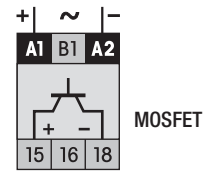
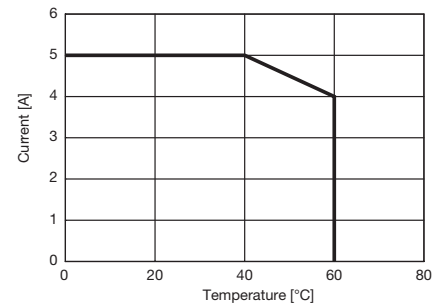
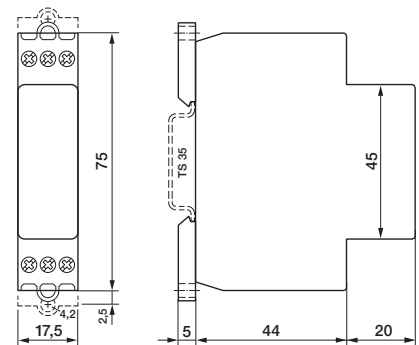

Fig.1 Output derating curve



Dimensions



Technical approvals, conformities



IEC/EN 50155, IEC/EN 60730



Maximum contact load	16 A / 250 V AC-1 16 A / 24 V DC-1
Recommended minimum contact load	100 mA / 12 V

Time functions and related connection diagrams (Function diagrams: refer to page 148)
The functions are selectable by rotary switch

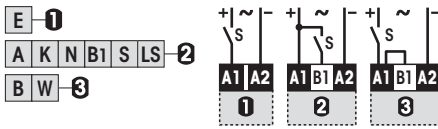

LED function table:

LED	Relay	Time run
OFF	OFF	NO
Continuous ON	ON	NO
Short blinking	OFF	YES
Long blinking	ON	YES

Time data

7 partial time ranges, t_{max} (rotary switch)	0.6, 6, 60 s / 6, 60 min / 6, 60 h
Fine adjustment range (rotary knob)	$t_{min} \dots t_{max}, 0.5 \dots 6$
Time range tolerance	$t_{min}: -5 \% \dots +0 \% / t_{max}: -0 \% \dots +5 \%$
Repetition accuracy	$\pm 0.1 \%$ or DC: 2 ms / AC: 10 ms
Response time, power on, on A1	≤ 45 ms
Min. trigger pulse on B1	20 ms (AC / DC)
Reset time B1 (AC/DC)	≤ 30 ms
Voltage failure buffering (50 / 60 Hz)	≥ 20 ms

Contacts

Material	W / AgSnO ₂
Rated operational current at 40 °C / 60 °C	16 A / 13 A
Max. inrush current	165 A / 20 ms
	800 A / 200 μ s
Max. switching voltage AC-1	250 V
Max. AC load AC-1 (Fig.1)	4 kVA
Max. DC load DC-1 24 V	384 W

Power supply- and control input

Nominal voltage (A1, B1)	UC 24-240 V (UC = AC / DC)
Operating voltage range	16.8 ... 250 V
Power consumption	1.2 VA / 0.43 W
Frequency range	16 ... 60 Hz
Allowed DC residual current into B1	≤ 0.5 mA
AC Neon lamp residual current into B1	≤ 10 mA
Trigger threshold voltage on B1, AC / DC	15 / 17 V

Insulation

Test voltage open contact	1 kV rms / 1 min
Test voltage between contacts and control input	2.5 kV rms / 1 min

Specifications

Ambient temperature storage /operation	-40 ... 85 °C / -40 ...60 °C (no ice)
Mechanical life of contact	5 x 1'000'000 operations
Conductor cross section	Stranded wire 2.5 mm ² , 2 x 1.5 mm ²
Protection degree	IP 20
Nominal screw torque	0.4 Nm
Housing material / weight	Lexan / 70 g
Mounting	TS-35 or Back Panel Mounting

Product References

Standard CIM14/UC24-240V



Connection diagram

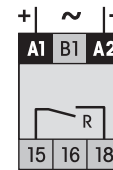

Fig.1 AC voltage endurance

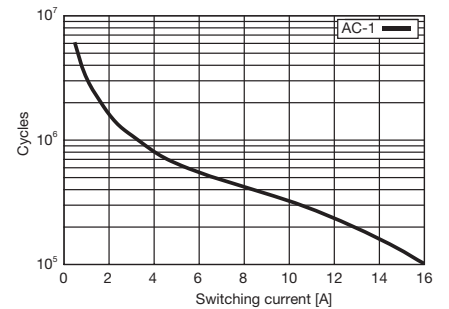
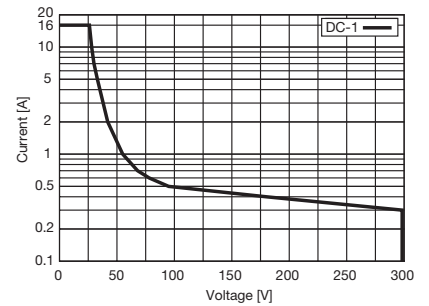
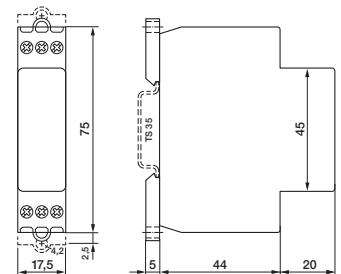

Fig. 2 DC load limit curve



Dimensions



Technical approvals, conformities



IEC/EN 50155, IEC/EN 60730



Maximum contact load	16 A / 250 V AC-1 16 A / 24 V DC-1
Recommended minimum contact load	10 mA / 10 V

Time functions and related connection diagrams (Function diagrams: refer to page 148)
The functions are selectable by rotary switch

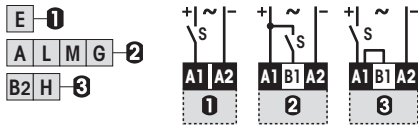

LED function table:

LED	Relay	Time run
OFF	OFF	NO
Continuous ON	ON	NO
Short blinking	OFF	YES
Long blinking	ON	YES

Time data

7 partial time ranges, t_{max} (rotary switch)	0.6, 6, 60 s / 6, 60 min / 6, 60 h
Fine adjustment range (rotary knob)	$t_{min} \dots t_{max}$, 0.5 ... 6
Time range tolerance	t_{min} : -5 % ... +0 % / t_{max} : -0 % ... +5 %
Repetition accuracy	± 0.1 % or DC: 2 ms / AC: 10 ms
Response time, power on, on A1	≤ 45 ms
Min. trigger pulse on B1	20 ms (AC / DC)
Reset time B1 (AC/DC)	≤ 30 ms
Voltage failure buffering (50 / 60 Hz)	≥ 20 ms

Contacts

Material CIM2 / CIM2R / Type	AgNi / 1 CO, micro disconnection
Rated operational current at 40 °C / 60 °C	16 A / 13 A
Max. inrush current	30 A
Max. switching voltage AC-1	250 V
Max. AC load AC-1 (Fig.1)	4 kVA
Max. DC load DC-1 30 V / 250 V (Fig.2)	240 W / 85 W

Power supply- and control input

Nominal voltage (A1, B1)	UC 24-240 V (UC = AC / DC)
Operating voltage range	UC 19 ... 250 V
Power consumption	approx. 1 W
Frequency range	15 ... 60 Hz
Allowed DC residual current into B1	≤ 0.5 mA
AC Neon lamp residual current into B1	≤ 10 mA
Trigger threshold voltage on B1, AC / DC	15 / 17 V

Insulation

Test voltage open contact	1 kV rms / 1 min
Test voltage between contacts and control input	2.5 kV rms / 1 min

Specifications

Ambient temperature storage /operation	-40 ... 85 °C / -40 ...60 °C (Railway: -46 °C) (no ice)
Mechanical life of contact	30 x 1'000'000 operations
Conductor cross section	Stranded wire 2.5 mm ² , 2 x 1.5 mm ²
Protection degree	IP 20
Nominal screw torque	0.4 Nm
Housing material / weight	Lexan / 70 g
Mounting	TS-35 or Back Panel Mounting

Product References

Standard	CIM2/UC24-240V
Railway	CIM2R/UC24-240V



Connection diagram

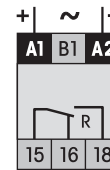

Fig.1 AC voltage endurance

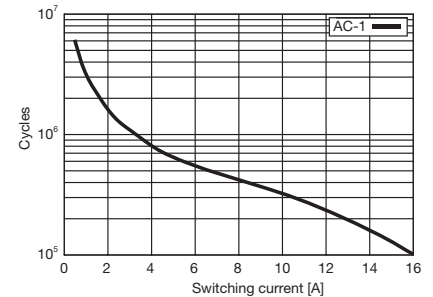
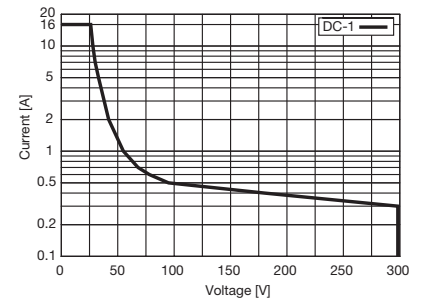
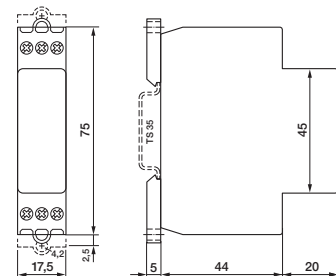

Fig. 2 DC load limit curve



Dimensions



Technical approvals, conformities



IEC/EN 50155, IEC/EN 60730

CIM22, CIM22R

Multifunction | 24-240 V AC / DC



TURCK



Maximum contact load 2 A / 250 V AC-1
Minimum contact load 50 mA

Time functions and related connection diagrams (Function diagrams: refer to page 148)
 The functions are selectable by rotary switch

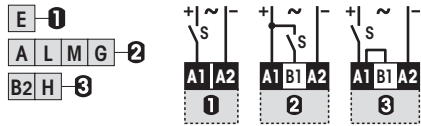

LED function table:

LED	Relay	Time run
OFF	OFF	NO
Continuous ON	ON	NO
Short blinking	OFF	YES
Long blinking	ON	YES

Time data

7 partial time ranges, t_{max} (rotary switch) 0.6, 6, 60 s / 6, 60 min / 6, 60 h
 Fine adjustment range (rotary knob) $t_{min} \dots t_{max}$, 0.5 ... 6
 Time range tolerance t_{min} : -5 % ... +0 % / t_{max} : -0 % ... +5 %
 Repetition accuracy ± 0.1 % or DC: 2 ms / AC: 10 ms
 Response time, power on, on A1 ≤ 45 ms
 Min. trigger pulse on B1 20 ms (AC / DC)
 Reset time B1 (AC/DC) ≤ 30 ms
 Voltage failure buffering (50 / 60 Hz) ≥ 20 ms

Output

Type Triac, zero crossing
 Rated operational current at 40 °C (Fig.1) 2 A
 Max. inrush current (10 ms) 100 A
 Max. switching voltage 250 V
 Max. AC load AC-1 300 VA
 I²t value 78 A²s
 Leakage current < 1 mA

Power supply- and control input

Nominal voltage **UC 24-240 V (UC = AC / DC)**
 Operating voltage range UC 19 ... 250 V
 Power consumption approx. 1 W
 Frequency range 15 ... 60 Hz
 Allowed DC residual current into B1 ≤ 0.5 mA
 AC Neon lamp residual current into B1 ≤ 10 mA
 Trigger threshold voltage on B1, AC / DC 15 / 17 V

Insulation

Test voltage between output and control input 2.5 kV rms / 1 min

Specifications

Ambient temperature storage /operation -40 ... 85 °C / -40 ... 60 °C
 (Railway: -70 °C) (no ice)
 Conductor cross section Stranded wire 2.5 mm², 2 x 1.5 mm²
 Protection degree IP 20
 Nominal screw torque 0.4 Nm
 Housing material / weight Lexan / 70 g
 Mounting TS-35 or Back Panel Mounting

Product References

Standard CIM22/UC24-240V
Railway CIM22R/UC24-240V



Connection diagram

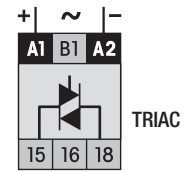
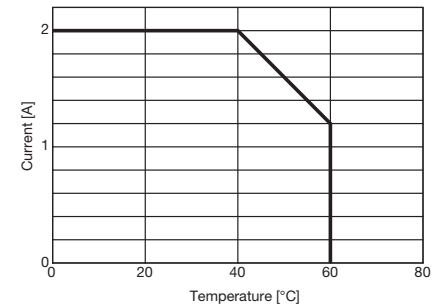
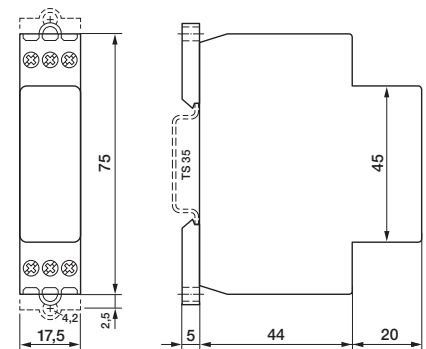

Fig.1 Output derating curve



Dimensions



Technical approvals, conformities



IEC/EN 50155, IEC/EN 60730

CIM23, CIM23R

Multifunction | 24-240 V AC / DC



Maximum contact load 4 A / 30 V DC-1
Recommended minimum contact load 1 mA

Time functions and related connection diagrams (Function diagrams: refer to page 148)
 The functions are selectable by rotary switch

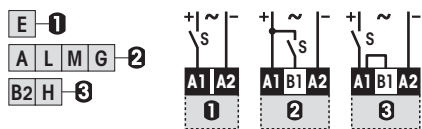

LED function table:

LED	Relay	Time run
OFF	OFF	NO
Continuous ON	ON	NO
Short blinking	OFF	YES
Long blinking	ON	YES

Time data

7 partial time ranges, t_{max} (rotary switch) 0.6, 6, 60 s / 6, 60 min / 6, 60 h
 Fine adjustment range (rotary knob) $t_{min} \dots t_{max}, 0.5 \dots 6$
 Time range tolerance $t_{min}: -5 \% \dots +0 \% / t_{max}: -0 \% \dots +5 \%$
 Repetition accuracy $\pm 0.1 \%$ or DC: 2 ms / AC: 10 ms
 Response time, power on, on A1 ≤ 45 ms
 Min. trigger pulse on B1 20 ms (AC / DC)
 Reset time B1 (AC/DC) ≤ 30 ms
 Voltage failure buffering (50 / 60 Hz) ≥ 20 ms

Output

Type MOS FET
 Rated operational current (Fig. 1) 4 A
 Max. inrush current (10 μ s) 40 A
 Max. switching voltage 30 V
 Leakage current $< 10 \mu$ A

Power supply- and control input

Nominal voltage (UC = AC / DC) **UC 24-240 V (UC = AC / DC)**
 Operating voltage range UC 19 ... 250 V
 Power consumption approx. 1 W
 Frequency range 15 ... 60 Hz
 Allowed DC residual current into B1 ≤ 0.5 mA
 AC Neon lamp residual current into B1 ≤ 10 mA
 Trigger threshold voltage on B1, AC / DC 15 / 17 V

Insulation

Test voltage between output and control input 2.5 kV rms / 1 min

Specifications

Ambient temperature storage /operation $-40 \dots 85 \text{ }^\circ\text{C} / -40 \dots 60 \text{ }^\circ\text{C}$
 (Railway: $-70 \text{ }^\circ\text{C}$) (no ice)
 Conductor cross section Stranded wire 2.5 mm², 2 x 1.5 mm²
 Protection degree IP 20
 Nominal screw torque 0.4 Nm
 Housing material / Weight Lexan / 70 g
 Mounting TS-35 or Back Panel Mounting

Product References

Standard CIM23/UC24-240V
Railway CIM23R/UC24-240V



Connection diagram

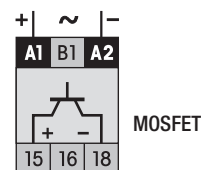
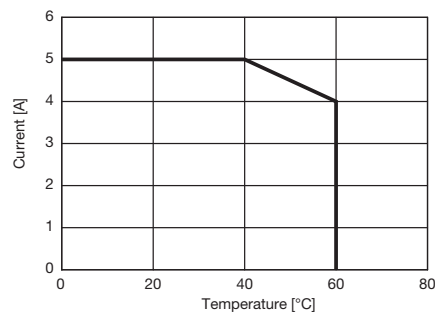
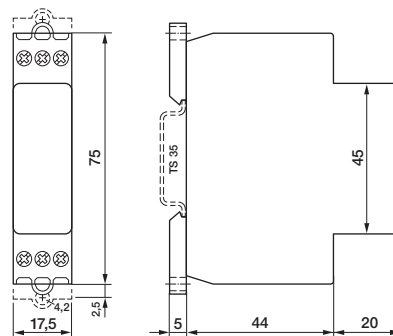

Fig.1 Output derating curve



Dimensions



Technical approvals, conformities



IEC/EN 50155, IEC/EN 60730



Maximum contact load	16 A / 250 V AC-1 16 A / 24 V DC-1
Recommended minimum contact load	10 mA / 10 V

Time functions and related connection diagrams (Function diagrams: refer to page 148)
The functions are selectable by rotary switch

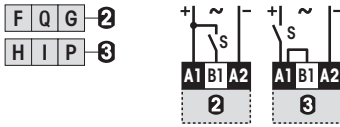

LED function table:

LED	Relay	Time run
OFF	OFF	NO
Continuous ON	ON	NO
Short blinking	OFF	YES
Long blinking	ON	YES

Time data

7 partial time ranges, t_{max} (rotary switch)	0.6, 6, 60 s / 6, 60 min / 6, 60 h
Fine adjustment range (rotary knob)	$t_{min} \dots t_{max}$, 0.5 ... 6
Time range tolerance	t_{min} : -5 % ... +0 % / t_{max} : -0 % ... +5 %
Repetition accuracy	± 0.1 % or DC: 2 ms / AC: 10 ms
Response time, power on, on A1	≤ 45 ms
Min. trigger pulse on B1	20 ms (AC / DC)
Reset time B1 (AC/DC)	≤ 30 ms
Voltage failure buffering (50 / 60 Hz)	≥ 20 ms

Contacts

Material CIM3 / CIM3R / Type	AgNi / 1 CO, micro disconnection
Rated operational current at 40 °C / 60 °C	16 A / 13 A
Max. inrush current	30 A
Max. switching voltage AC-1	250 V
Max. AC load AC-1 (Fig.1)	4 kVA
Max. DC load DC-1 30 V / 250 V (Fig.2)	240 W / 85 W

Power supply- and control input

Nominal voltage (A1, B1)	UC 24-240 V (UC = AC / DC)
Operating voltage range	UC 19 ... 250 V
Power consumption	approx. 1 W
Frequency range	15 ... 60 Hz
Allowed DC residual current into B1	≤ 0.5 mA
AC Neon lamp residual current into B1	≤ 10 mA
Trigger threshold voltage on B1, AC / DC	15 / 17 V

Insulation

Test voltage open contact	1 kV rms / 1 min
Test voltage between contacts and control input	2.5 kV rms / 1 min

Specifications

Ambient temperature storage /operation	-40 ... 85 °C / -40 ...60 °C (Railway: -46 °C) (no ice)
Mechanical life of contact	30 x 1'000'000 operations
Conductor cross section	Stranded wire 2.5 mm ² , 2 x 1.5 mm ²
Protection degree	IP 20
Nominal screw torque	0.4 Nm
Housing material / weight	Lexan / 70 g
Mounting	TS-35 or Back Panel Mounting

Product References

Standard	CIM3/UC24-240V
Railway	CIM3R/UC24-240V



Connection diagram

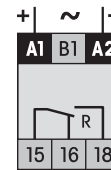

Fig.1 AC voltage endurance

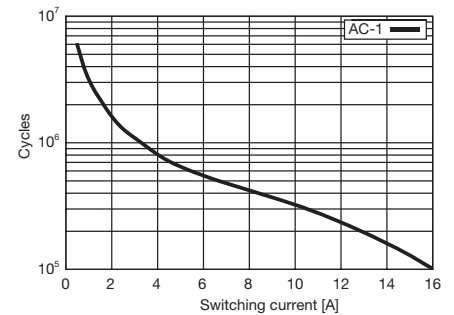
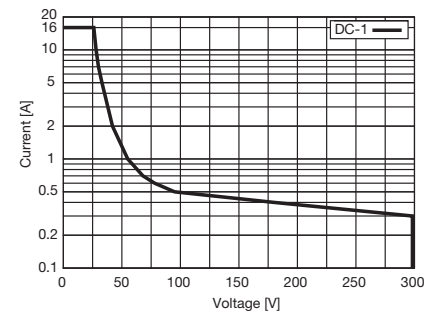
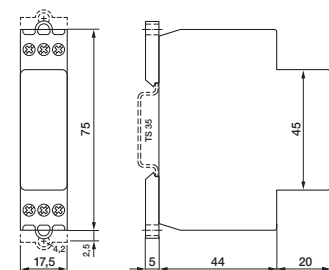

Fig. 2 DC load limit curve



Dimensions



Technical approvals, conformities



IEC/EN 50155, IEC/EN 60730



Maximum contact load 2 A / 250 V AC-1
Minimum contact load 50 mA

Time functions and related connection diagrams (Function diagrams: refer to page 148)
The functions are selectable by rotary switch

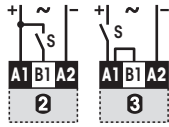
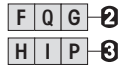

LED function table:

LED	Relay	Time run
OFF	OFF	NO
Continuous ON	ON	NO
Short blinking	OFF	YES
Long blinking	ON	YES

Time data

7 partial time ranges, t_{max} (rotary switch) 0.6, 6, 60 s / 6, 60 min / 6, 60 h
 Fine adjustment range (rotary knob) $t_{min} \dots t_{max}$, 0.5 ... 6
 Time range tolerance t_{min} : -5 % ... +0 % / t_{max} : -0 % ... +5 %
 Repetition accuracy ± 0.1 % or DC: 2 ms / AC: 10 ms
 Response time, power on, on A1 ≤ 45 ms
 Min. trigger pulse on B1 20 ms (AC / DC)
 Reset time B1 (AC/DC) ≤ 30 ms
 Voltage failure buffering (50 / 60 Hz) ≥ 20 ms

Output

Type Triac, zero crossing
 Rated operational current at 40 °C (Fig.1) 2 A
 Max. inrush current (10 ms) 100 A
 Max. switching voltage 250 V
 Max. AC load AC-1 300 VA
 I^2t value 78 A²s
 Leakage current < 1 mA

Power supply- and control input

Nominal voltage **UC 24-240 V (UC = AC / DC)**
 Operating voltage range UC 19 ... 250 V
 Power consumption approx. 1 W
 Frequency range 15 ... 60 Hz
 Allowed DC residual current into B1 ≤ 0.5 mA
 AC Neon lamp residual current into B1 ≤ 10 mA
 Trigger threshold voltage on B1, AC / DC 15 / 17 V

Insulation

Test voltage between output and control input 2.5 kV rms / 1 min

Specifications

Ambient temperature storage /operation -40 ... 85 °C / -40 ... 60 °C (No Ice)
 (Railway: -70 °C) (No Ice)
 Conductor cross section Stranded wire 2.5 mm², 2 x 1.5 mm²
 Protection degree IP 20
 Nominal screw torque 0.4 Nm
 Housing material / weight Lexan / 70 g
 Mounting TS-35 or Back Panel Mounting

Product References

Standard CIM3/UC24-240V
Railway CIM3R/UC24-240V



Connection diagram

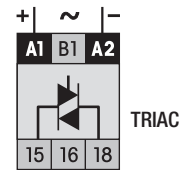
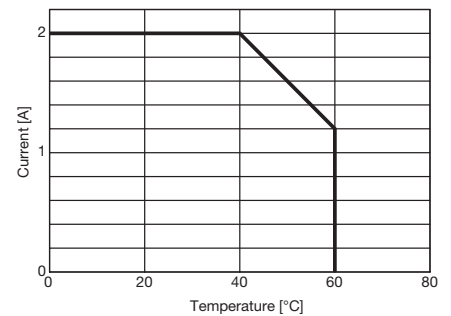
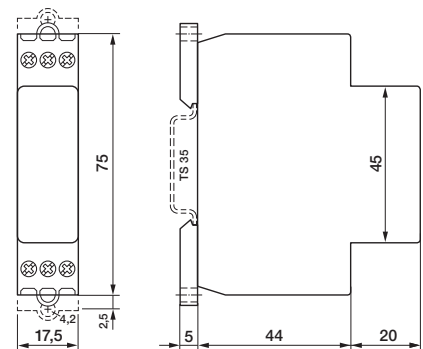

Fig.1 Output derating curve



Dimensions



Technical approvals, conformities



IEC/EN 50155, IEC/EN 60730



Maximum contact load 4 A / 30 V DC-1
Recommended minimum contact load 1 mA

Time functions and related connection diagrams (Function diagrams: refer to page 148)
 The functions are selectable by rotary switch

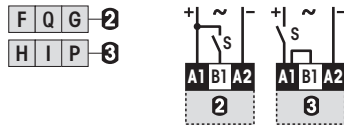

LED function table:

LED	Relay	Time run
OFF	OFF	NO
Continuous ON	ON	NO
Short blinking	OFF	YES
Long blinking	ON	YES

Time data

7 partial time ranges, t_{max} (rotary switch) 0.6, 6, 60 s / 6, 60 min / 6, 60 h
 Fine adjustment range (rotary knob) $t_{min} \dots t_{max}$, 0.5 ... 6
 Time range tolerance t_{min} : -5 % ... +0 % / t_{max} : -0 % ... +5 %
 Repetition accuracy ± 0.1 % or DC: 2 ms / AC: 10 ms
 Response time, power on, on A1 ≤ 45 ms
 Min. trigger pulse on B1 20 ms (AC / DC)
 Reset time B1 (AC/DC) ≤ 30 ms
 Voltage failure buffering (50 / 60 Hz) ≥ 20 ms

Output

Type MOS FET
 Rated operational current (Fig. 1) 4 A
 Max. inrush current (10 μ s) 40 A
 Max. switching voltage 30 V
 Leakage current $< 10 \mu$ A

Power supply- and control input

Nominal voltage (UC = AC / DC) **UC 24-240 V (UC = AC / DC)**
 Operating voltage range UC 19 ... 250 V
 Power consumption approx. 1 W
 Frequency range 15 ... 60 Hz
 Allowed DC residual current into B1 ≤ 0.5 mA
 AC Neon lamp residual current into B1 ≤ 10 mA
 Trigger threshold voltage on B1, AC / DC 15 / 17 V

Insulation

Test voltage between output and control input 2.5 kV rms / 1 min

Specifications

Ambient temperature storage / operation -40 ... 85 °C / -40 ... 60 °C (No Ice)
 (Railway: -70 °C) (No Ice)
 Conductor cross section Stranded wire 2.5 mm², 2 x 1.5 mm²
 Protection degree IP 20
 Nominal screw torque 0.4 Nm
 Housing material / Weight Lexan / 70 g
 Mounting TS-35 or Back Panel Mounting

Product References

Railway **CIM33R/UC24-240V**



Connection diagram

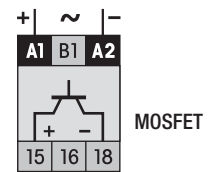
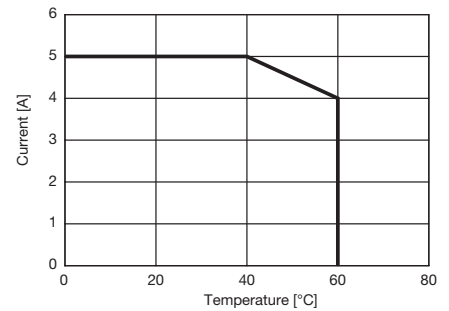
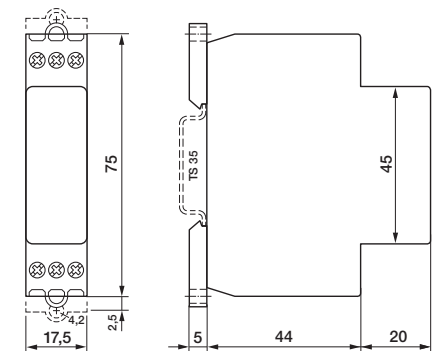

Fig.1 Output derating curve



Dimensions



Technical approvals, conformities



IEC/EN 50155, IEC/EN 60730

2.3 Time Cubes

Application	Types
CT Series	
8-pin and 11-pin Timecube	CT2, CT3

CT2, CT3

8-pin and 11-pin Timecube®

Time functions (Function diagrams: refer to page 148)

Operating voltage controlled types

CT2- / CT3-E30: Function E, on delay
CT2- / CT3-W30: Function W, one shot
CT2- / CT3-B30: Function B, blinker

Trigger input controlled types

CT2- / CT3-A30, off delay
CT2- / CT3-K30, pulse shaping

Time data

4 partial time ranges (DIP switch)

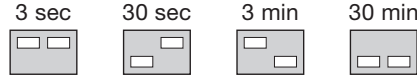

Fine adjustment time range (rotary knob)

$t_{min} \dots t_{max}, 2 \dots 30$

Time range tolerance

$t_{min}: 0 \dots +35\%$

Repetition accuracy

$\pm 0.5\%$ or $\pm 20\text{ ms}$

Reset time

$\leq 200\text{ ms}$

Reset time B1 (trigg. inp.) A, K

$\leq 80\text{ ms}$

Voltage failure buffering

5 ms (except the relay)

Power supply- and control input (UC = AC or DC)

CT2- / CT3- ... / S	DC 9.5 ... 18 V	12 mA
CT2- / CT3- ... / L	UC 20 ... 65 V	6 mA
CT2- / CT3- ... / M	UC 90 ... 150 V	2 mA
CT2- / CT3- ... / U	UC 180 ... 265 V	2 mA
CT2- / CT3- ... / H	UC 90 ... 265 V	2 mA
Residual current E, W, B	$\leq 0.3\text{ mA}$	
Residual current B1 (trigg. inp.) A, K	$\leq 0.2\text{ mA}$	

Specifications

Ambient temperature storage / operation	-40 ... +70 °C / -25 ... +60 °C (no ice)
Protection degree	IP40
Housing material	Lexan
Weight	35 g
Mounting	Socket

Product References

8 pole	11 pole	Voltage
CT2-E30/S CT2-B30/S CT2-A30/S CT2-K30/S	CT3-E30/S CT3-B30/S CT3-A30/S CT3-K30/S	DC 9.5...18 V
CT2-E30/L CT2-B30/L CT2-A30/L CT2-K30/L	CT3-E30/L CT3-B30/L CT3-A30/L CT3-K30/L	UC 20...65 V
CT2-A30/M CT2-K30/M	CT3-A30/M CT3-K30/M	UC 90...150 V
CT2-A30/U CT2-K30/U	CT3-A30/U CT3-K30/U	UC 180...265 V
CT2-E30/H CT2-B30/H	CT3-E30/H CT3-B30/H	UC 90...265 V

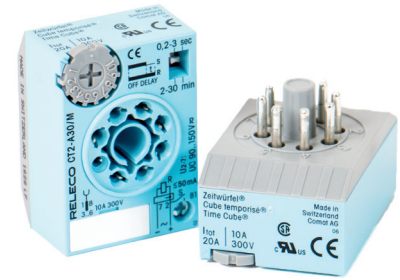

Wiring diagram

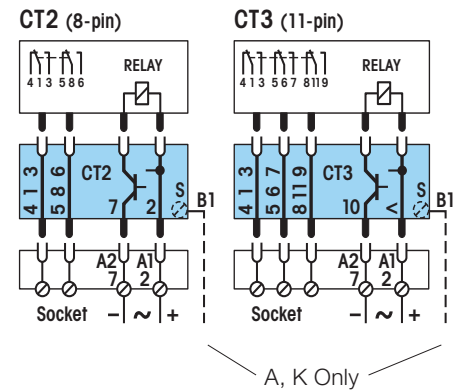

Order Number

2 = 8-pole
3 = 11-pole

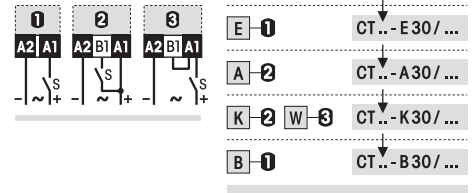

Dimensions

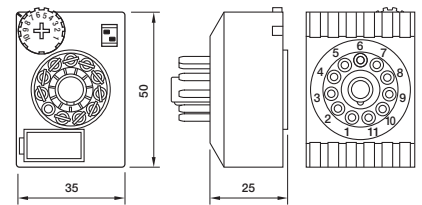

Only 11-pin version shown.
The dimension of the 8-pin version are identical

Technical approvals, conformities



2.4 Time Modules

Application	Types	Contacts	AC ratings	DC ratings	Socket
CT Series					
Multifunction Time Module	CT32R	-	-	-	S3-M / S5-M
Multifunction Time Module	CT33R	-	-	-	S3-M / S5-M
Multifunction Time Module	CT36R	-	-	-	S3-M / S5-M

The modular Comat timer CT System

The time delay relays and monitoring relays consist of plug-in CT electronic modules and 11-pole output relays. Both system components can be combined in a variety of combinations. This allows adapting the system for the specific application.

Subsequent modifications, for example a change from mechanical contacts to solid-state outputs, are possible at any time just by replacing the relay.

This system provides the user a complete universal system with worldwide unmatched flexibility.

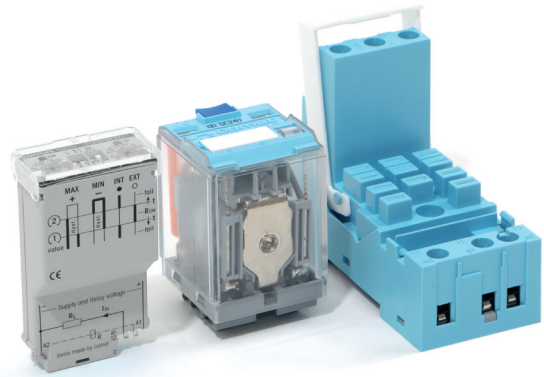

The system sockets S3-MB0 or C-155 serve as a basis for the secure reception of the electronic modules. The sockets have a 4-pole module slot in which the CT modules lock firmly and vibration proof also without the output relay. Contact is made with reliable twin knife contacts.

With the A2 connector bridge "C-A2", the neutral conductor (N/-) can be connected from socket to socket. It reduces wiring work considerably.

Robust terminals for wires up to 4mm² and spacious labeling are other advantages of this practical Comat modular system.

Clear markings close to the terminal connections on the sockets make it easy to identify the connections for wiring and servicing.

The CT modules are proof of the practical oriented experiences of Comat in the field of industrial electronics. All control and display elements are arranged easy accessible at all times on the front side of the modules. The functions and settings are self-explanatory schematically illustrated on the front and allow to review the set values also during operation.

A transparent cover over the module setting components provides protection from unintentional settings and additionally links the module to the output relay.

Triggering is performed with the operating voltage. (L1 or +). No potential-free contacts are therefore required. The triggering complies to machine standards. Parallel connection to B1 is admissible.

The wide UC voltage range (AC/DC) of the modules give a wide flexibility. It permits the connection to AC or DC supplies and provides a high level of reliability in triggering.

Note: In case of even wider voltage ranges, for example UC 24-240V, triggering currents on B1 are often in the range of 100µA with simultaneous low threshold voltages of less than 20V. Due to capacitive or inductive pickups this may lead to unintentional triggering or switching errors caused by insufficient load on the control contacts (It is not seldom that 50V or more can be measured in open lines).

The output relays show the connection diagram and the technical values on the front side, (exception C3 and C5 relays). A color code indicates an AC coil with red and a DC coil with blue color. Most of the relays have a lockable test button for manual operation.

The standard contacts have proven its reliability for high switching current applications over many years. The contact material AgNi permits a wide switching range and due to the large dimensioning they are designed for a high number of switching cycles. The high breaking capacity of up to 10A/400V and a low load switching capability of 12V/10mA makes the contact suitable for the use in main circuits as well as for low voltage applications.

The twin contacts are switching the load circuit with 2 independent contact tongues. The switching safety for low currents is therefore 100 times higher compared to a single contact relay. Despite the high switching capacity of up to 6A/250V, these contacts are very suitable to switch low currents and voltages up to 1mA/6V.

The solid-state relays are an alternative to mechanical relays. In the standard version, the relay has a potential-free universal semiconductor output for AC or DC loads. The advantage is a bouncing- and wear-free, overload resistant, short circuit protected output with a practical unlimited life cycle.

Solid-state relays are specially recommended for applications of high switching cycles, for example for repeat cycle timers, flushing lights, but also for high inductive switching loads of solenoid valves, couplings, motors, etc. The solid state relays are also suitable for capacitive loads, for example long power lines, or compensated lighting circuits.

Additional protection circuits of the output or of the load are not necessary in any application for this type of Comat relays.

The solid-state relays are insensitive in any aggressive environment such as chemical plants, sewage plants etc. and are therefore an excellent choice for the employment in such environments.



The train symbol indicates products available in a special railway execution according EN 50155. Please refer to our special railway brochure for details.

2.4 Time Modules
CT32R, CT33R, CT36R
Multifunction Time Module

Time functions and related connection diagrams (Function diagrams: refer to page 148)

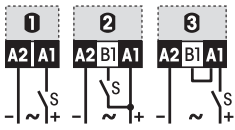

CT32R
 Universal

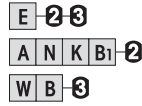

CT33R
 Universal

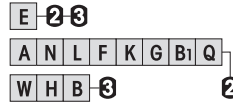

CT36R
 Repeat cycle timer



Time data

	CT 32R	CT33R	CT36R
Type			
Partial time ranges, t_{max}	1.5, 6, 15, 60 /s /min	150, 600 ms	2 x 600 ms
Min. time t_{min}	1.5, 6, 15, 60 /s /min /h	2 x 6, 60 /s /min /h	
Fine adj. range $t_{min} \dots t_{max}$	0.15 s	30 ms	2 x 50 ms
Time range tolerance	1 ... 1 0	0.2 ... 1	2 x 5 ... 60
Repetition accuracy	-25 ... 0 %	-25 ... 0 %	-25 ... 0 %
Temperature drift of time	0 ... 25 %	0 ... 25 %	0 ... 25 %
Min. trigger pulse width B1	± 0.2 % or 20 ms	± 0.2 % or 20 ms	± 0.2 % or 20 ms
Reset time pow. supply	0.1 % / K	0.1 % / K	0.1 % / K
Voltage failure buffering	≥ 30 ms	≥ 30 ms	-
	≤ 150 ms	≤ 150 ms	≤ 150 ms
	≥ 20 ms	≥ 20 ms	≥ 20 ms

Output data

Nominal voltage	110 – 240, 115, 230 V, UC 24-48V, UC 110-240V, DC 110V, UC 115V, UC 230V		
Type	Solid state		
Rated operational current	50 mA		
On-state resistance	$\leq 100 \Omega$		
Leakage current	$\leq 150 \mu A$		

Power supply and control input (UC = AC / DC)

	CT36R	CT36R	CT32R
Type	CT36R	CT36R	CT32R
Nominal voltage	UC 24 – 48 V	UC 110 – 240 V	DC 110 V
Operating voltage range	19...60 V	82 ... 265 V	77...138 V
Supply current	6 ... 12 mA	4 ... 8 mA	1...3 mA
Type	CT32R, CT33R	CT32R, CT33R	CT32R, CT33R
Nominal voltage	UC 24 – 48 V	UC 115 V	UC 230 V
Operating voltage range	19 ... 60 V	90 ... 150 V	180 ... 265 V
Input B1 inactive	≤ 9 V	≤ 60 V	≤ 100 V
Supply current	5 ... 11 mA	4 ... 7 mA	1 ... 4 mA

Specification

Ambient temperature storage /operation	-40 ... 85 °C / -40 ... 60 °C (no ice)
Housing material	Lexan
Weight	25 g
mounting	Socket

Product References

CT32R, CT33R, CT36R, UC24-48 V	CT3xR/UC24-48V R
CT36, UC110-240 V	CT3xR/UC110-240V R
CT32, CT33, UC115 V	CT3xR/UC115V R
CT32, CT33, UC230 V	CT3xR/UC230V R

Dimensions

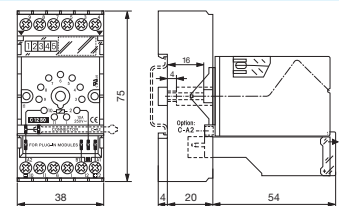



Technical approvals, conformities



3.0 Monitoring & Measuring Devices



3.1 Multifunction Monitoring

Application	Types	Monitoring	Monitoring ratings	Output contacts	Design
MRM Series					
Multifunction monitoring AC / DC single phase	MRM11		U, I, P, f, cosφ	1 CO	35 mm
Multifunction monitoring AC / DC three phase	MRM32		U, I, P, f, cosφ	2 CO	35 mm

Monitoring function

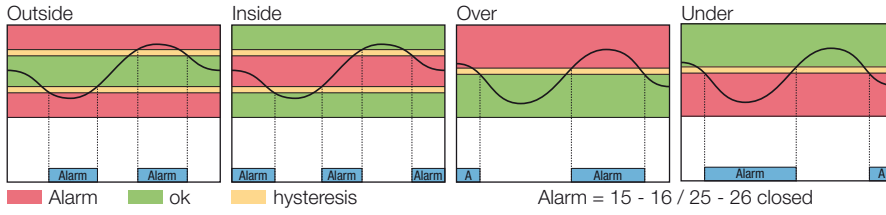

Measuring circuit data

Voltage setting ranges AC / DC	0.1 ... 480 V / ±0.1 ... 690 V
Current setting ranges AC / DC	0.1 ... 5 A
Frequency	AC 15 ... 150 Hz
Input resistance U / I	1 MΩ / 5 MΩ
Measured variables	U, I, f, P, S, cosφ

Time data

Voltage failure buffering	ca. 30 ms
---------------------------	-----------

Alarm contacts

Type / Material	⚡ 1 CO / AgNi 0.15
Rated operational current	6 A
Max. inrush current	15 A
Max. switching voltage	250 V
Max. AC load AC-1 (Fig.1)	1250 VA
Max. DC load DC-1, 24 V / 220 V (Fig.2)	120 W / 25 W
Recommended min. contact load	10 mA / 10 V
Alarm delay setting time	0.1 ... 999.9 s (factory adjustment = 0.0 s)
Reset time setting range	0.1 ... 999.9 s (factory adjustment = 0.0 s)

Power supply

	UC12-48V	UC110-240V
Nominal voltage AC/DC	12 ... 48 V	110 ... 240 V
Operating voltage range	10 ... 60 V	85 ... 250 V
AC frequency	16 ... 63 Hz	16 ... 63 Hz
Power consumption	1.6 W / 3.2 VA	1.5 W / 2.6 VA

Insulation

Measuring input – Measuring input	1.5 kV 1 minute
Measuring input – Supply	2.0 kV 1 minute
Measuring input – Contact	2.0 kV 1 minute
Supply – Contact	2.0 kV 1 minute
Contact set – Contact set	1.5 kV 1 minute

Specifications

Ambient temperature storage /operation	-40 ... +85 °C / -40 ... +60 °C (no ice) LCD: -20 ... +60 °C (no ice)
Mechanical life of contacts	30 x 1 000 000 operations
Conductor cross section	Stranded wire 2.5 mm ² , 2 x 1.5 mm ²
Protection degree	IP20, (electronics: IP40)
Nominal screw torque	0.4 Nm
Housing material	Lexan EXL 9330
Weight	107 g

Product References

AC/DC 12-48 V, 15...60 Hz
AC/DC 110-240 V, 15...60 Hz

MRM11/UC12-48V
MRM11/UC110-240V



Connection diagram

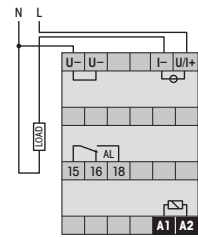

Fig.1 AC voltage endurance

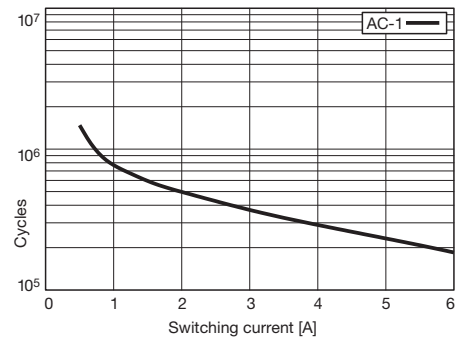
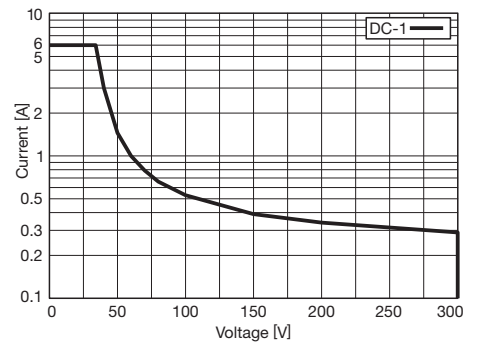
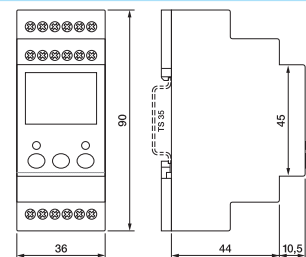

Fig. 2 DC load limit curve



Dimensions [mm]



Technical approvals, conformities



IEC/EN 60730 IEC/EN 60947

MRM32

Multifunction Monitoring | AC / DC three phase

Monitoring function

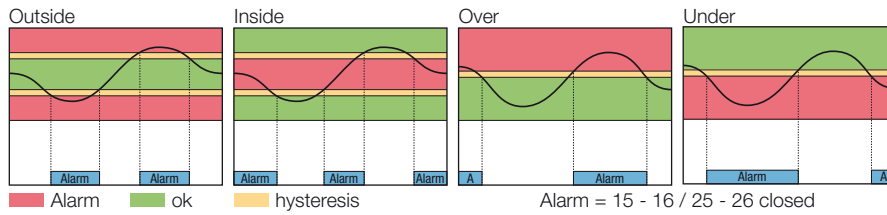

Measuring circuit data

Voltage setting ranges AC / DC	0.1 ... 480 V / ±0.1 ... 690 V
Current setting ranges AC / DC	0.1 ... 5 A
Frequency	AC 15 ... 150 Hz
Input resistance U / I	1 MΩ / 5 MΩ
Measured variables	U, I, f, P, S, cosφ und Δφ (phase sequence)

Time data

Voltage failure buffering	ca. 30 ms
---------------------------	-----------

Contacts

Type / Material	2 CO / AgNi 0.15
Rated operational current	6 A
Max. inrush current	15 A
Max. switching voltage	250 V
Max. AC load AC-1 (Fig.1)	1250 VA
Max. DC load DC-1, 24 V / 220 V (Fig.2)	120 W / 25 W
Recommended min. contact load	10 mA / 10 V
Alarm delay setting time	0.1 ... 999.9 s (factory adjustment = 0.0 s)
Reset time setting range	0.1 ... 999.9 s (factory adjustment = 0.0 s)

Power supply

	UC12-48V	UC110-240V
Nominal voltage AC/DC	12 ... 48 V	110 ... 240 V
Operating voltage range	10 ... 60 V	85 ... 250 V
AC frequency	16 ... 63 Hz	16 ... 63 Hz
Power consumption	1.6 W / 3.2 VA	1.5 W / 2.6 VA

Insulation

Measuring input – Measuring input	1.5 kV 1 minute
Measuring input – Supply	2.0 kV 1 minute
Measuring input – Contact	2.0 kV 1 minute
Supply – Contact	2.0 kV 1 minute
Contact set – Contact set	1.5 kV 1 minute

Specifications

Ambient temperature storage /operation	-40 ... +85 °C / -40 ... +60 °C (no ice) LCD: -20 ... +60 °C (no ice)
Mechanical life of contacts	30 x 1'000'000 operations
Conductor cross section	Stranded wire 2.5 mm ² , 2 x 1.5 mm ²
Protection degree	IP20, (electronics: IP40)
Nominal screw torque	0.4 Nm
Housing material	Lexan EXL 9330
Weight	125 g

Product References

AC/DC 12-48 V, 15...60 Hz	MRM32/UC12-48V
AC/DC 110-240 V, 15...60 Hz	MRM32/UC110-240V



Connection diagram

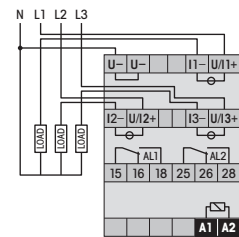

Fig.1 AC voltage endurance

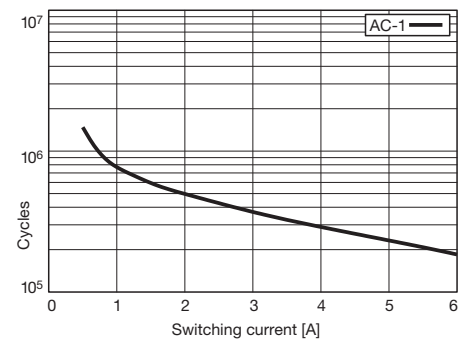
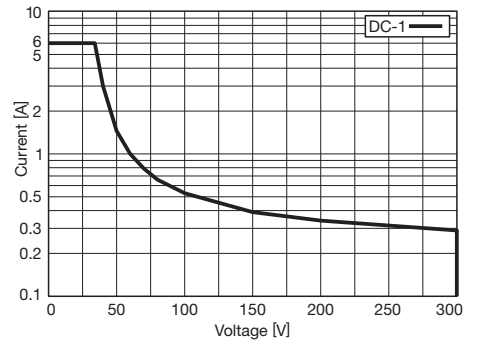
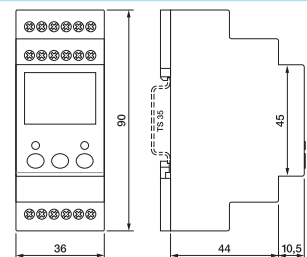

Fig. 2 DC load limit curve



Dimensions [mm]





Technical approvals, conformities



IEC/EN 60730 IEC/EN 60947

3.2 Voltage Monitoring

Application	Types	Monitoring	Monitoring ratings	Output contacts	Design
MRU Series					
Voltage monitoring AC / DC single phase	MRU11		0.1 ... 480 V AC / 690 V DC	1 CO	35 mm
Voltage monitoring AC / DC three phase	MRU32		0.1 ... 480 V AC / 690 V DC	2 CO	35 mm

Monitoring function

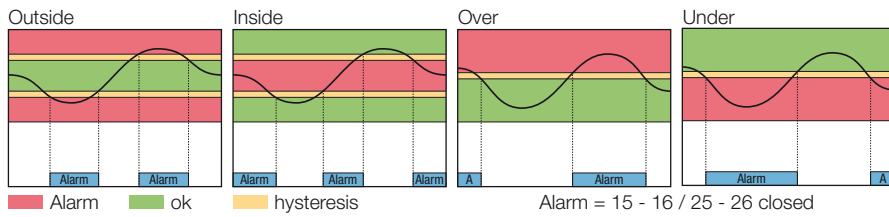

Measuring circuit data

Voltage setting ranges AC / DC	0.1 ... 480 V / ±0.1 ... 690 V
Frequency	AC 15 ... 150 Hz
Input resistance U / I	1 MΩ
Measured variables	U, f

Time data

Voltage failure buffering	ca. 30 ms
---------------------------	-----------

Alarm contacts

Type / Material	1 CO / AgNi 0.15
Rated operational current	6 A
Max. inrush current	15 A
Max. switching voltage	250 V
Max. AC load AC-1 (Fig.1)	1250 VA
Max. DC load DC-1, 24 V / 220 V (Fig.2)	120 W / 25 W
Recommended min. contact load	10 mA / 10 V
Alarm delay setting time	0.1 ... 999.9 s (factory adjustment = 0.0 s)
Reset time setting range	0.1 ... 999.9 s (factory adjustment = 0.0 s)

Power supply

	UC12-48V	UC110-240V
Nominal voltage AC/DC	12 ... 48 V	110 ... 240 V
Operating voltage range	10 ... 60 V	85 ... 250 V
AC frequency	16 ... 63 Hz	16 ... 63 Hz
Power consumption	1.6 W / 3.2 VA	1.5 W / 2.6 VA

Insulation

Measuring input – Measuring input	1.5 kV 1 minute
Measuring input – Supply	2.0 kV 1 minute
Measuring input – Contact	2.0 kV 1 minute
Supply – Contact	2.0 kV 1 minute
Contact set – Contact set	1.5 kV 1 minute

Specifications

Ambient temperature storage /operation	-40 ... +85 °C / -40 ... +60 °C (no ice) LCD: -20 ... +60 °C (no ice)
Mechanical life of contacts	30 x 1 000 000 operations
Conductor cross section	Stranded wire 2.5 mm ² , 2 x 1.5 mm ²
Protection degree	IP20, (electronics: IP40)
Nominal screw torque	0.4 Nm
Housing material	Lexan EXL 9330
Weight	107 g

Product References

AC/DC 12-48 V, 15...60 Hz
AC/DC 110-240 V, 15...60 Hz

MRU11/UC12-48V
MRU11/UC110-240V



Connection diagram

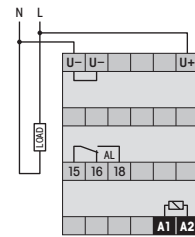

Fig.1 AC voltage endurance

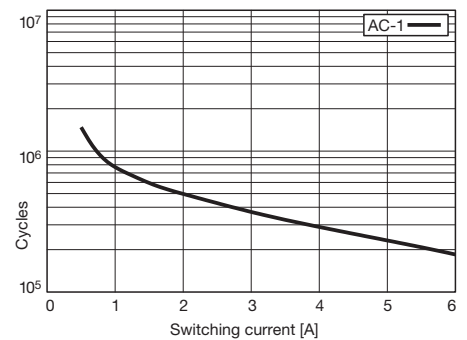
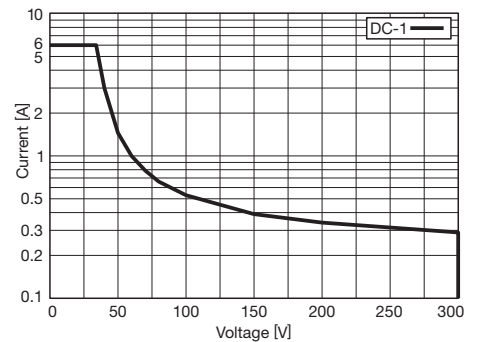
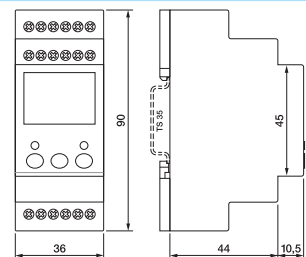

Fig. 2 DC load limit curve



Dimensions [mm]



Technical approvals, conformities



IEC/EN 60730 IEC/EN 60947

Monitoring function

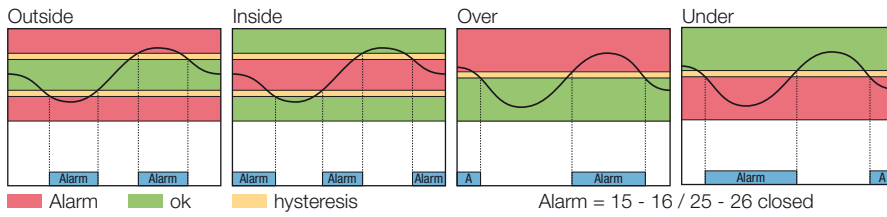

Measuring circuit data

Voltage setting ranges AC / DC	0.1 ... 480 V / ±0.1 ... 690 V
Frequency	AC 15 ... 150 Hz
Input resistance U / I	1 MΩ
Measured variables	U, f, Δφ (phase sequence)

Time data

Voltage failure buffering	ca. 30 ms
---------------------------	-----------

Alarm contacts

Type / Material	⚡ 2 CO / AgNi 0.15
Rated operational current	6 A
Max. inrush current	15 A
Max. switching voltage	250 V
Max. AC load AC-1 (Fig.1)	1250 VA
Max. DC load DC-1, 24 V / 220 V (Fig.2)	120 W / 25 W
Recommended min. contact load	10 mA / 10 V
Alarm delay setting time	0.1 ... 999.9 s (factory adjustment = 0.0 s)
Reset time setting range	0.1 ... 999.9 s (factory adjustment = 0.0 s)

Power supply

	UC12-48V	UC110-240V
Nominal voltage AC/DC	12 ... 48 V	110 ... 240 V
Operating voltage range	10 ... 60 V	85 ... 250 V
AC frequency	16 ... 63 Hz	16 ... 63 Hz
Power consumption	1.6 W / 3.2 VA	1.5 W / 2.6 VA

Insulation

Measuring input – Measuring input	1.5 kV 1 minute
Measuring input – Supply	2.0 kV 1 minute
Measuring input – Contact	2.0 kV 1 minute
Supply – Contact	2.0 kV 1 minute
Contact set – Contact set	1.5 kV 1 minute

Specifications

Ambient temperature storage /operation	-40 ... +85 °C / -40 ... +60 °C (no ice) LCD: -20 ... +60 °C (no ice)
Mechanical life of contacts	30 x 1 000 000 operations
Conductor cross section	Stranded wire 2.5 mm ² , 2 x 1.5 mm ²
Protection degree	IP20, (electronics: IP40)
Nominal screw torque	0.4 Nm
Housing material	Lexan EXL 9330
Weight	125 g

Product References

AC/DC 12-48 V, 15...60 Hz	MRU32/UC12-48V
AC/DC 110-240 V, 15...60 Hz	MRU32/UC110-240V



Connection diagram

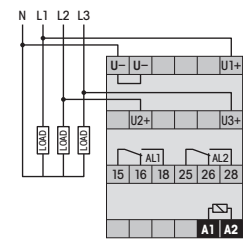

Fig.1 AC voltage endurance

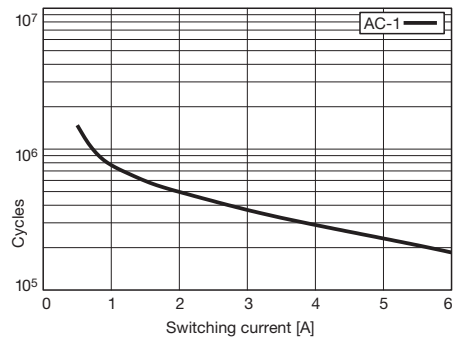
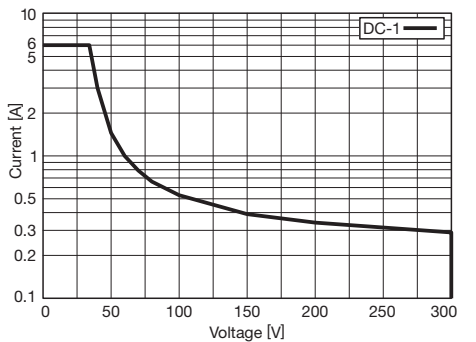
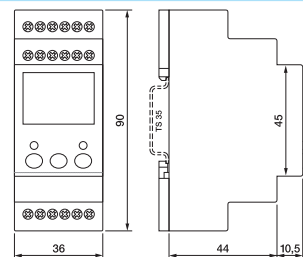

Fig. 2 DC load limit curve



Dimensions [mm]





Technical approvals, conformities



IEC/EN 60730 IEC/EN 60947

3.3 Current Monitoring

Application	Types	Monitoring	Monitoring ratings	Output contacts	Design
MRI Series					
Current monitoring AC / DC single phase	MRI11		0.1 ... 5 A	1 CO	35 mm
Current monitoring AC / DC three phase	MRI32		0.1 ... 5 A	2 CO	35 mm

Monitoring function

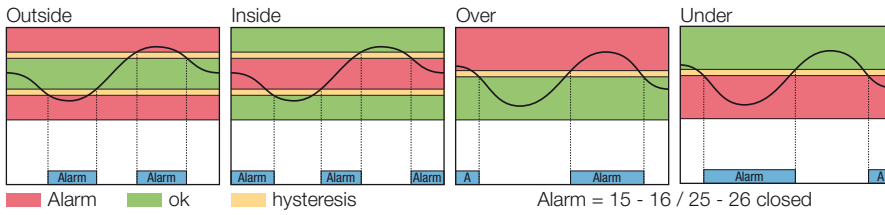

Measuring circuit data

Current setting ranges AC / DC	0.1 ... 5 A
Frequency	AC 15 ... 150 Hz
Input resistance U / I	5 MΩ
Measured variables	I, f

Time data

Voltage failure buffering	ca. 30 ms
---------------------------	-----------

Alarm contacts

Type / Material	1 CO / AgNi 0.15
Rated operational current	6 A
Max. inrush current	15 A
Max. switching voltage	250 V
Max. AC load AC-1 (Fig.1)	1250 VA
Max. DC load DC-1, 24 V / 220 V (Fig.2)	120 W / 25 W
Recommended min. contact load	10 mA / 10 V
Alarm delay setting time	0.1 ... 999.9 s (factory adjustment = 0.0 s)
Reset time setting range	0.1 ... 999.9 s (factory adjustment = 0.0 s)

Power supply

	UC12-48V	UC110-240V
Nominal voltage AC/DC	12 ... 48 V	110 ... 240 V
Operating voltage range	10 ... 60 V	85 ... 250 V
AC frequency	16 ... 63 Hz	16 ... 63 Hz
Power consumption	1.6 W / 3.2 VA	1.5 W / 2.6 VA

Insulation

Measuring input – Measuring input	1.5 kV 1 minute
Measuring input – Supply	2.0 kV 1 minute
Measuring input – Contact	2.0 kV 1 minute
Supply – Contact	2.0 kV 1 minute
Contact set – Contact set	1.5 kV 1 minute

Specifications

Ambient temperature storage /operation	-40 ... +85 °C / -40 ... +60 °C (no ice) LCD: -20 ... +60 °C (no ice)
Mechanical life of contacts	30 x 10 000 000 operations
Conductor cross section	Stranded wire 2.5 mm ² , 2 x 1.5 mm ²
Protection degree	IP20, (electronics: IP40)
Nominal screw torque	0.4 Nm
Housing material	Lexan EXL 9330
Weight	107 g

Product References

AC/DC 12-48 V, 15...60 Hz
AC/DC 110-240 V, 15...60 Hz

MRI11/UC12-48V
MRI11/UC110-240V



Connection diagram

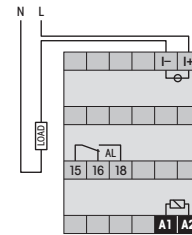

Fig.1 AC voltage endurance

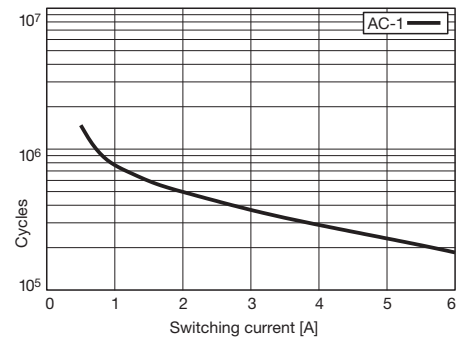
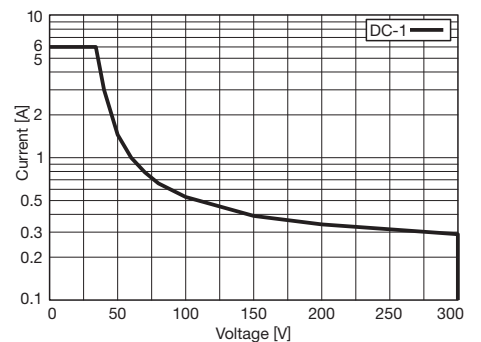
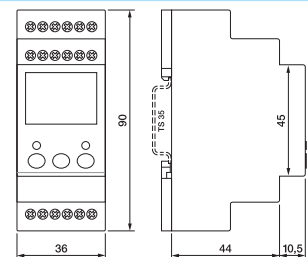

Fig. 2 DC load limit curve



Dimensions [mm]



Technical approvals, conformities



IEC/EN 60730 IEC/EN 60947

Monitoring function

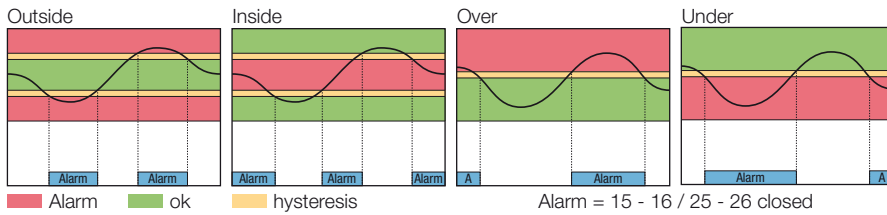

Measuring circuit data

Current setting ranges AC / DC	0.1 ... 5 A
Frequency	AC 15 ... 150 Hz
Input resistance U / I	5 MΩ
Measured variables	I, f

Time data

Voltage failure buffering	ca. 30 ms
---------------------------	-----------

Contacts

Type / Material	2 CO / AgNi 0.15
Rated operational current	6 A
Max. inrush current	15 A
Max. switching voltage	250 V
Max. AC load AC-1 (Fig.1)	1250 VA
Max. DC load DC-1, 24 V / 220 V (Fig.2)	120 W / 25 W
Recommended min. contact load	10 mA / 10 V
Alarm delay setting time	0.1 ... 999.9 s (factory adjustment = 0.0 s)
Reset time setting range	0.1 ... 999.9 s (factory adjustment = 0.0 s)

Power supply

	UC12-48V	UC110-240V
Nominal voltage AC/DC	12 ... 48 V	110 ... 240 V
Operating voltage range	10 ... 60 V	85 ... 250 V
AC frequency	16 ... 63 Hz	16 ... 63 Hz
Power consumption	1.6 W / 3.2 VA	1.5 W / 2.6 VA

Insulation

Measuring input – Measuring input	1.5 kV 1 minute
Measuring input – Supply	2.0 kV 1 minute
Measuring input – Contact	2.0 kV 1 minute
Supply – Contact	2.0 kV 1 minute
Contact set – Contact set	1.5 kV 1 minute

Specifications

Ambient temperature storage /operation	-40 ... +85 °C / -40 ... +60 °C (no ice)
	LCD: -20 ... +60 °C (no ice)
Mechanical life of contacts	30 x 10 000 000 operations
Conductor cross section	Stranded wire 2.5 mm ² , 2 x 1.5 mm ²
Protection degree	IP20, (electronics: IP40)
Nominal screw torque	0.4 Nm
Housing material	Lexan EXL 9330
Weight	125 g

Product References

AC/DC 12-48 V, 15...60 Hz
AC/DC 110-240 V, 15...60 Hz

MRI32/UC12-48V
MRI32/UC110-240V



Connection diagram

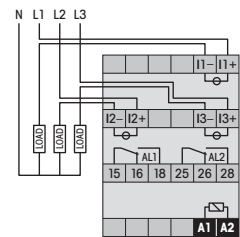

Fig.1 AC voltage endurance

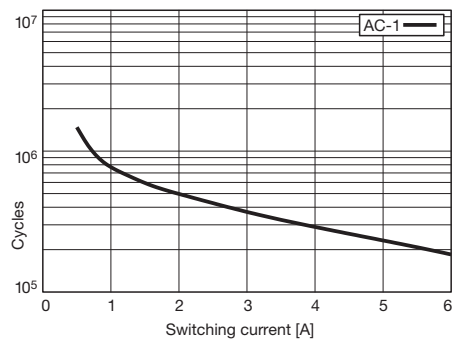
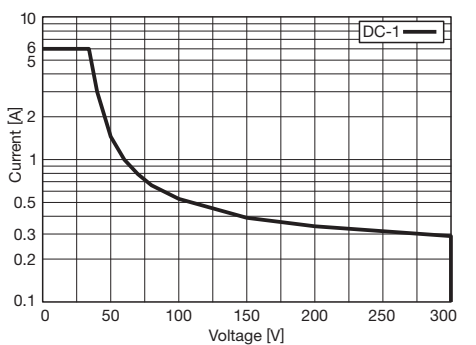
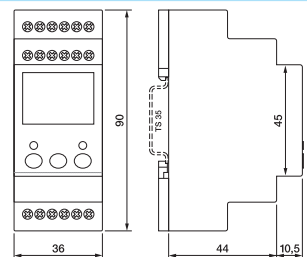

Fig. 2 DC load limit curve



Dimensions [mm]



Technical approvals, conformities



IEC/EN 60730 IEC/EN 60947

4.0 Sockets

Application	Types	Pins	Rated load
Socket for 8-pin Relays and Time Cubes	S2-B		10 A / 300 V
PCB Socket for 8-pin Relays and Time Cubes	S2-PO		10 A / 300 V
Socket for 11-pin Relays and Time Cubes	S3-B		10 A / 300 V
Socket for 11-pin standard Relays and Time Cubes	S3-S		10 A / 250 V
PCB Socket for 11-pin Relays and Time Cubes	S3-L / -PO		10 A / 250 V
System Socket for 11-pin Relays and Time / Monitoring Modules	S3-MB0 / S3-MB1		10 A / 250 V
System Socket for 11-pin Relays and Time / Monitoring Modules	S3-M		10 A / 250 V
Socket for 14-pin C4 Relays	S4-J		10 A / 250 V
PCB Socket for 14-pin C4 Relays	S4-L / -P		10 A / 250 V
Socket for 11-pin Relays	S5-M		16 A / 400 V
Socket for 11-pin Relays	S5-SSY		16 A / 400 V
PCB Socket for 11-pin Relays	S5-L / -P		16 A / 400 V
Socket for 8-pin Relays	S7-C		10 A / 250 V
Socket for 8-pin Relays	S7-IO		10 A / 250 V
PCB Socket for 8-pin Relays	S7-P		10 A / 250 V
Socket for 14-pin Relays	S9-M		6 A / 250 V
PCB Socket for 14-pin Relays	S9-P		6 A / 150 V
Socket for 5-pin Relays	S10		10 A / 250 V
PCB Socket for 8-pin Relays	S10-P		10 A / 250 V
Socket for 8-pin Relays	S12		5 A / 250 V
PCB Socket for 8-pin Relays	S12-P		5 A / 250 V
Socket for 8-pin Relays	S16-M		10 A / 300 V
Socket for 8-pin Relays	S18-M		10 A / 300 V

Socket selection for industrial Relays

Socket Selection for industrial Relays																	
Socket Type	Description	C2	C3	C4	C5	C7	C9	C10	C12	C16PTL / C18PTL	C18-A15PT	C21	C22	C31	C32	R7	R-Module
EC-11	Socket for industrial Relay		●											●	●		
S2-B	Socket for industrial Relay	●															
S2-S	Socket for industrial Relay											●	●				
S2-L	Socket for industrial Relay	●															
S2-P	Socket for industrial Relay																
S2-P0	Socket for industrial Relay																
S3-B	Socket for industrial Relay		●											●	●		
S3-MP	Socket for industrial Relay		●											●	●		
S3-S	Socket for industrial Relay		●											●	●		
S3-L	Socket for industrial Relay		●														
S3-P	Socket for industrial Relay																
S3-P0	Socket for industrial Relay																
S3-MB0	Socket for industrial Relay		●											●	●		●
S3-MB1	Socket for industrial Relay																
S3-N	Socket for industrial Relay																
S4-J	Socket for industrial Relay			●													
S4-L	Socket for industrial Relay			●													
S4-P	Socket for industrial Relay																
S5-M	Socket for industrial Relay				●												●
S5-L	Socket for industrial Relay																
S5-P	Socket for industrial Relay																
S7-C	Socket for industrial Relay					●										●	●
S7-I0	Socket for industrial Relay					●										●	●
S7-16	Socket for industrial Relay					●										●	●
S7-P	Socket for industrial Relay					●										●	
S7-L,	Socket for industrial Relay					●										●	
S7-P0	Socket for industrial Relay																
S9-M	Socket for industrial Relay						●										
S9-P	Socket for industrial Relay						●										
S9-L	Socket for industrial Relay						●										
S9-P0	Socket for industrial Relay																
S10	Socket for industrial Relay							●									
S10-P	Socket for industrial Relay							●									
S12	Socket for industrial Relay								●								
S12-P	Socket for industrial Relay								●								
S16-M	Socket for industrial Relay									●							●
S18-M	Socket for industrial Relay										●						●

Socket Accessoires																	
Type	Description	S3-M	S3-MB0	S3-MB1	S2-B	S3-B	S5-M	S7-C	S10	S7-I0	S12	S9-M	S4-J	S7-L	S7-P	S9-L	S9-P
CA-11	Code Ring (BAG 5 PCS)					●											
CA-8	Code Ring (BAG 5 PCS)				●												
C-A2	Neutral-Connector (BAG 5 PCS or 50 PCS)	●	●	●			●										
SC-3	A1-Connector (BAG 10 PCS)		●	●			●										
LH-1	Label carrier transparent (BAG 5 PCS)	●	●	●													
SL-36	Label holder transparent (BAG 5 PCS)				●	●											
SP-36	Labeling strips (BAG 5 PCS)				●	●											
L-16	Labeling strips (BAG 5 PCS)	●	●	●													
SD-1T	Lock lid transparent (BAG 5 PCS)	●	●	●			●										
SD-1W	Lock lid white (BAG 5 PCS)	●	●	●			●										
B20-G	Bridge Bar grey (BAG 5 PCS)										●						
B20-R	Bridge Bar red (BAG 5 PCS)										●						
B20-A	Bridge Bar blue (BAG 5 PCS)										●						
CC-30	Clip grey																
CMX1	LED-Module																
CMR1	R/C-Module																
PS-W	Labeling strips							●									
S7-BB	Bridge bar (BAG 5 PCS (5 x 4))							●		●							
S9-CH	Labeling srib white (BAG 10 PCS)									●		●					
S10-BB	Bridge bar (BAG 20 PCS (5 x 4))								●								
S10-RH	Labeling srib white (BAG 10 PCS)								●		●						
S10-RT	Transparent Cover (BAG 20 PCS)								●								
SA-0	Wall Adapter							●	●		●						
SS-T	Transparent Cover							●									
SS-W	White Cover							●									
V10-G	Bridge Bar grey (BAG 5 PCS)										●						
V10-R	Bridge Bar red (BAG 5 PCS)										●						
V10-A	Bridge Bar blue (BAG 5 PCS)										●						
V40-G	Bridge Bar grey (BAG 5 PCS)										●						
V40-R	Bridge Bar red (BAG 5 PCS)										●						
V40-A	Bridge Bar blue (BAG 5 PCS)										●						

S2-B

Socket for 8-pin Relays and Time Cubes

Rated Load **10 A / 300 V**

Specifications

Rated impulse withstand voltage	2.5 kV rms / 1 min
– All terminals / DIN rail	2.5 kV rms / 1 min
– Terminal / Terminal	2.5 kV rms / 1 min
Cross-section of connecting wire	
– Single-wire	4 mm ² / AWG 12 or 2 x 2.5 mm ² / AWG 14
– Multi-wire	0.34 mm ² / AWG 22 - 2.5 mm ² / AWG 14
Nominal screw torque	0.7 Nm
Screw dimensions	M3 Pozi slot
Mounting	TS-35 or Back Panel Mounting
Ambient temperature operation / storage	-40...60 °C / -40 ... 80 °C (no ice)
Weight	48g

Included Accessories

Retaining Clip, plastic S30-CM for C2 / C2x Relays

Optional Accessories

Retaining clip, steel HF-32 (BAG 10 PCS) for C2 / C2x Relays
HF-33 (BAG 10 PCS) for Time Cube CTx



Connection diagram

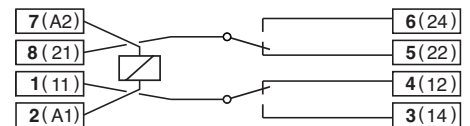

Dimensions [mm]

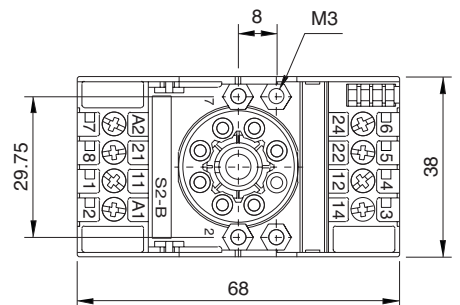
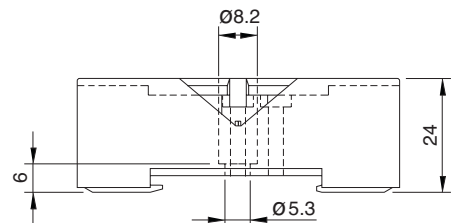

Technical approvals, conformities



S2-PO

PCB Socket for 8-pin Relays and Time Cubes

Rated Load	10 A / 300 V
Specifications	
Rated impulse withstand voltage	2.5 kV rms / 1 min
- Pin / Pin	-40 ... 60 °C / -40 ... 80 °C (no ice)
Ambient temperature operation/storage	
Weight	17g
Optional Accessories	
Retaining clip, steel	HF-32 (BAG 10 PCS) for C2 / C2x Relays HF-33 (BAG 10 PCS) for Time Cube CTx



Printed circuit lay-out [mm]

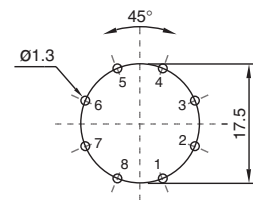

Dimensions [mm]

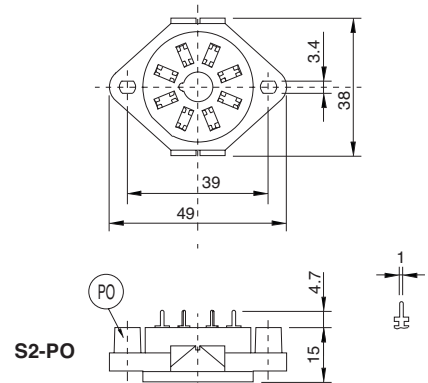

Technical approvals, conformities



S3-B

Socket for 11-pin Relays and Time Cubes

Rated Load	10 A / 300 V
Specifications	
Rated impulse withstand voltage	2.5 kV rms / 1 min
- All terminals / DIN rail	2.5 kV rms / 1 min
- Terminal / Terminal	2.5 kV rms / 1 min
Cross-section of connecting wire	
- Single-wire	4 mm ² / AWG 12 or 2 x 2.5 mm ² / AWG 14
- Multi-wire	0.34 mm ² / AWG 22 - 2.5 mm ² / AWG 14
Nominal screw torque	0.7 Nm
Screw dimensions	M3 Pozi slot
Mounting	TS-35 or Back Panel Mounting
Ambient temperature	-40 ... 60 °C / -40 ... 80 °C (no ice)
Weight	55g

Included Accessories	
Retaining Clip, plastic	S30-CM for C3 / C3x Relays
Optional Accessories	
Retaining clip, steel	HF-32 (BAG 10 PCS) for C3 / C3x Relays HF-33 (BAG 10 PCS) for Time Cube CTx
Coding Ring	S3-BC (BAG 5 PCS) for C3 / C3x Relays



Connection diagram

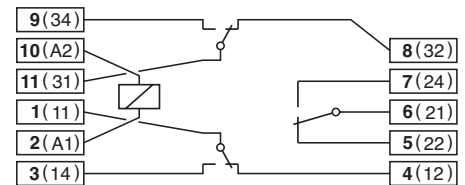

Dimensions [mm]

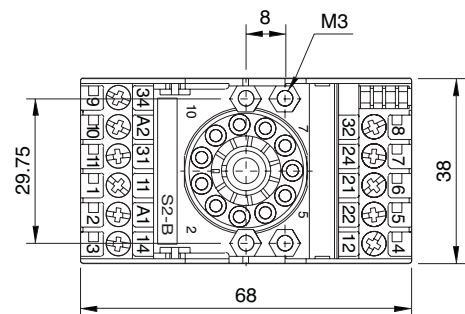
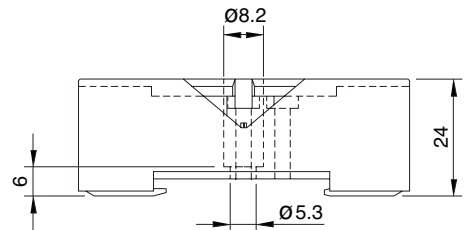

Technical approvals, conformities



4.0 Sockets

4

S3-S

Socket for 11-pin standard Relays and Time Cubes

Rated Load	10 A / 250 V
Specifications	
Rated impulse withstand voltage	
– All terminals / DIN rail	2.5 kV rms / 1 min
– Terminal / Terminal	2.5 kV rms / 1 min
Cross-section of connecting wire	
– Single-wire	4 mm ² / AWG 12 or 2 x 2.5 mm ² / AWG 14
– Multi-wire	0.34 mm ² / AWG 22 - 2.5 mm ² / AWG 14
Nominal screw torque	1.2 Nm
Screw dimensions	M3.5 Pozi slot
Mounting	TS-35 or Back Panel Mounting
Ambient temperature operation/storage	-40...60 °C / -40 ... 80 °C (no ice)
Weight	69g

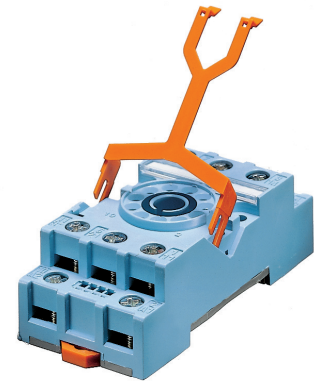

Included Accessories	
Retaining Clip, plastic	S30-CM for C3 / C3x Relays
Optional Accessories	
Retaining clip, steel	HF-32 (BAG 10 PCS) for C3 / C3x Relays HF-33 (BAG 10 PCS) for Time Cube CTx
Coding Ring	S3-BC (BAG 5 PCS) for C3 / C3x Relays



Connection diagram

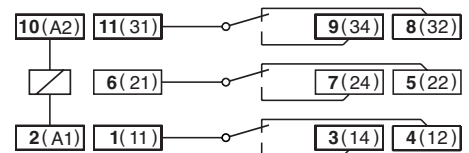

Dimensions [mm]

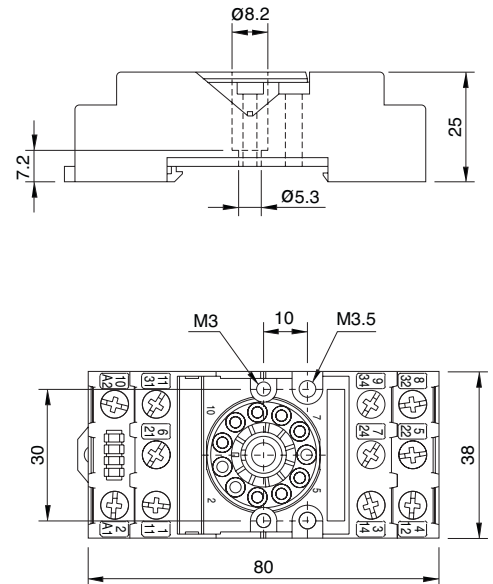

Technical approvals, conformities



Rated Load	10 A / 250 V
-------------------	---------------------

Specifications

Rated impulse withstand voltage	
- Pin / Pin	2.5 kV rms / 1 min
Ambient temperature operation/storage	-4060 °C /-40 ... 80 °C (no ice)
Weight	17g

Optional Accessories

Retaining spring, steel	HF-32 (BAG 10 PCS) for C3 / C3x Relays
-------------------------	--



Printed circuit lay-out [mm]

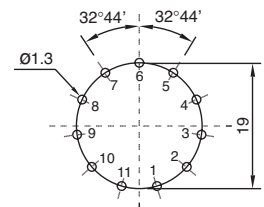

Dimensions [mm]

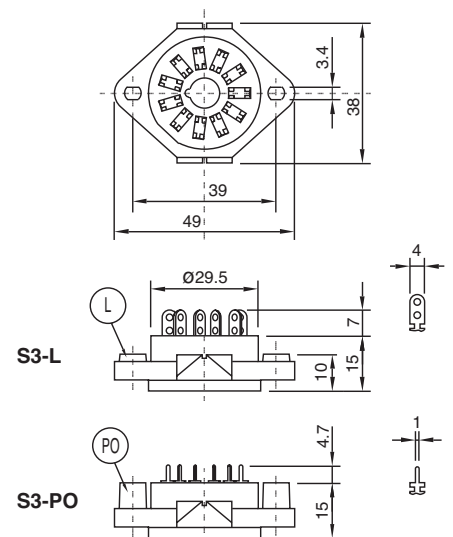

4.0 Sockets

4

Technical approvals, conformities





Socket for 11-pin Relays and Time / Monitoring Module

Rated Load **10 A / 250 V**

Specifications

Rated impulse withstand voltage

- All terminals / DIN rail 2.5 kV rms / 1 min
- Terminal / Terminal 2.5 kV rms / 1 min

Cross-section of connecting wire

- Single-wire 1 x 6 mm²/ AWG 10, 2 x 1.5 mm²/ AWG 16
- Multi-wire 1 x 4 mm²/AWG 12, 2 x 1.5 mm²/AWG 16

Nominal screw torque

0.7 Nm

Screw dimensions

M3 Pozi slot

Mounting

TS-35 or Back Panel Mounting

Ambient temperature operation/storage

-25 ...60 °C /-40 ... 80 °C (no ice)

Weight

61g

Included Accessories

A2-Connector C-A2

Optional Accessories

- Retaining clip, steel HF-32 (BAG 10 PCS) for C3 / C3x Relays
- Coding Ring HF-33 (BAG 10 PCS) for Time Cube CTx
- A2-Connector S3-BC (BAG 5 PCS) for C3 / C3x Relays
- Freewheeling Diode Module C-A2 (BAG 5 PCS), C-A2 (BAG 50 PCS)
- RC-Suppressor Module RD1/DC12-220V
- RC1/UC110-240V

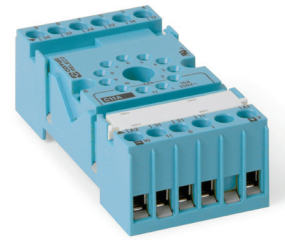

Connection diagram

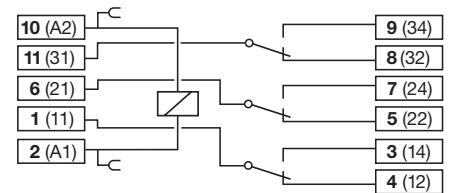

Dimensions [mm]

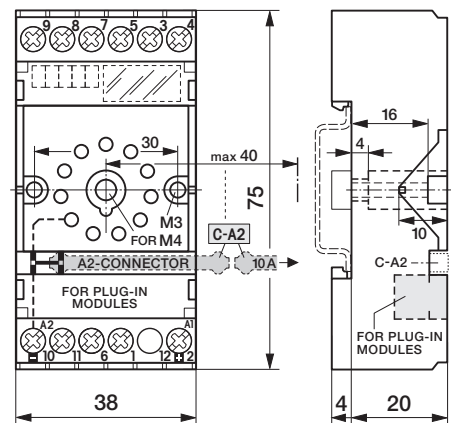

Technical approvals, conformities



IEC/EN 50155



Socket for 11-pin Relays and Time / Monitoring Module

Rated Load	10 A / 250 V
-------------------	---------------------

Specifications	
Rated impulse withstand voltage	2.5 kV rms / 1 min
- All terminals / DIN rail	2.5 kV rms / 1 min
- Terminal / Terminal	2.5 kV rms / 1 min
Cross-section of connecting wire	
- Single-wire	1 x 6 mm ² / AWG 10, 2 x 1.5 mm ² / AWG 16
- Multi-wire	1 x 4 mm ² /AWG 12, 2 x 1.5 mm ² /AWG 16
Nominal screw torque	0.7 Nm
Screw dimensions	M3 Pozi slot
Mounting	TS-35 or Back Panel Mounting
Ambient temperature operation/storage	-25 ...60 °C /-40 ... 80 °C (no ice)
Weight	61g

Included Accessories	
A2-Connector	C-A2

Optional Accessories	
Retaining clip, steel	HF-32 (BAG 10 PCS) for C3 / C3x Relays HF-33 (BAG 10 PCS) for Time Cube CTx
Coding Ring	S3-BC (BAG 5 PCS) for C3 / C3x Relays
A2-Connector	C-A2 (BAG 5 PCS), C-A2 (BAG 50 PCS)
Freewheeling Diode Module	RD1/DC12-220V
RC-Suppressor Module	RC1/UC110-240V

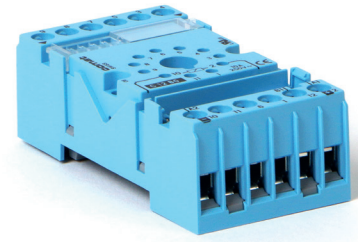

Connection diagram S3-MB0

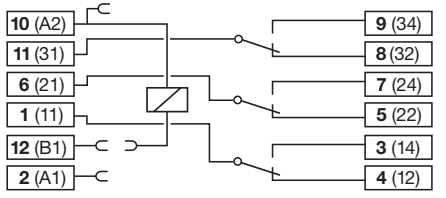

Connection diagram S3-MB1

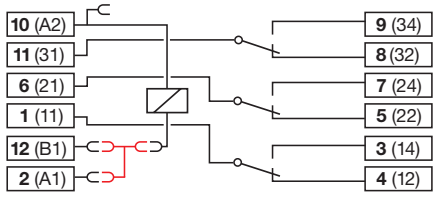

With Bridge Connector SC-3

Dimensions [mm]

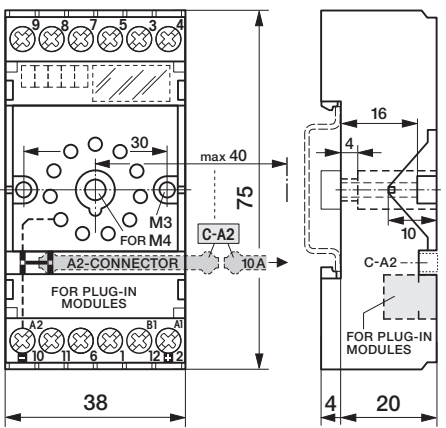

Technical approvals, conformities



S4-J

Socket for 14-pin C4 Relays

Rated Load	10 A / 250 V
Specifications	
Rated impulse withstand voltage	2.5 kV rms / 1 min
- All terminals / DIN rail	2.5 kV rms / 1 min
- Terminal / Terminal	
Cross-section of connecting wire	
- Single-wire	4 mm ² / AWG 12 or 2 x 2.5 mm ² / AWG 14
- Multi-wire	0.34 mm ² / AWG 22 - 2.5 mm ² / AWG 14
Nominal screw torque	1 Nm
Screw dimensions	M3.5 Philips-slot (combo)
Mounting	TS-35 or Back Panel Mounting
Ambient temperature	-40 ... 60 °C / -40 ... 80 °C (no ice)
Weight	80g

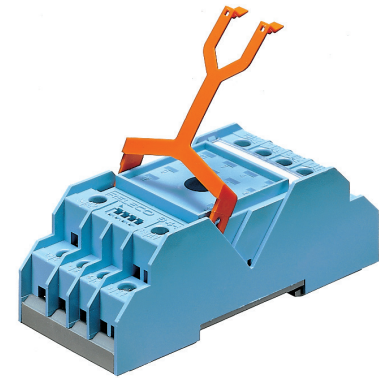

Included Accessories	
Retaining Clip, plastic	S3-C for C4 / C4x Relays
Optional Accessories	
Retaining Clip, plastic	S3-C (BAG 10 PCS) for C4 Relays



Connection diagram

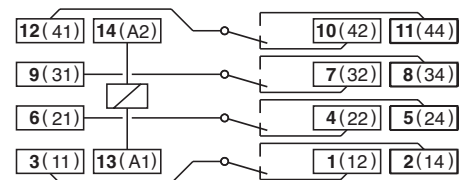

Dimensions [mm]

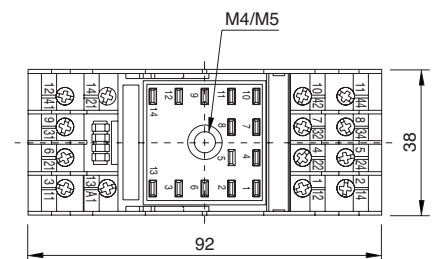
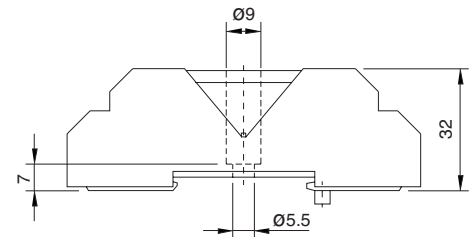

Technical approvals, conformities



4.0 Sockets
S4-L, S4-P

PCB Socket for 14-pin C4 Relays

Rated Load	10 A / 250 V
Specifications	
Rated impulse withstand voltage	2.5 kV rms / 1 min
- Pin / Pin	-30 °C ... +60 °C (no ice)
Ambient temperature	-30 °C ... +60 °C (no ice)
Weight	21g
Optional Accessories	
Retaining spring, steel	S4-CL for C4 / C4x Relays

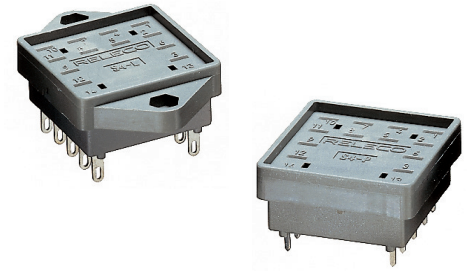

Printed circuit lay-out [mm]

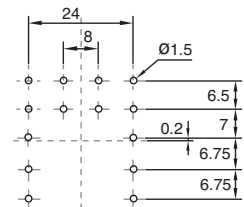

Dimensions [mm]

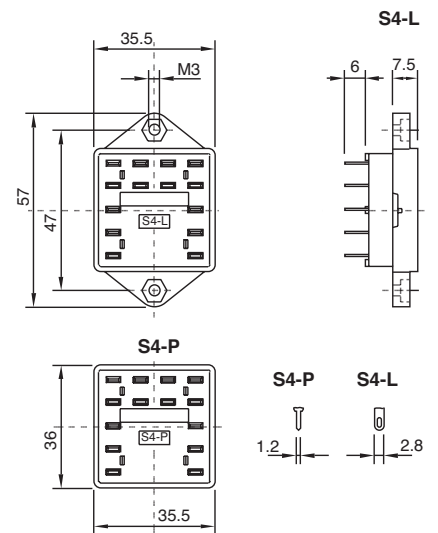

4.0 Sockets

4

Technical approvals, conformities



S5-M

Socket for 11-pin Relays

Rated Load	16 A / 400 V
Specifications	
Rated impulse withstand voltage	4 kV rms / 1 min
- All terminals / DIN rail	4 kV rms / 1 min
- Terminal / Terminal	4 kV rms / 1 min
Cross-section of connecting wire	
- Single-wire	1 x 6 mm ² / AWG 10, 2 x 2.5 mm ² / AWG 14
- Multi wire	1 x 6 mm ² / AWG 10, 2 x 1.5 mm ² / AWG 16
Nominal screw torque	1 Nm
Screw dimensions	M3.5 Pozi slot
Mounting	TS-35 or Back Panel Mounting
Ambient temperature operation / storage	-40 ... 60° C / -40 ... 80° C (no ice)
Weight	92g

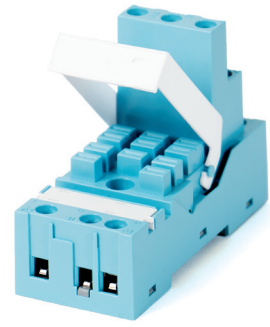

Integrated Accessories	
A2-Connector	C-A2
Retaining clip, plastic	S5M-CP for C5 / C5x Relays
A1-, B1-Connector	SC-3

Optional Accessories	
Retaining Clip, steel	HF-32 (BAG 10 PCS) for C5 / C5x Relays
A2-Connector	C-A2 (BAG 5 PCS), C-A2 (BAG 50 PCS)
A1-, B1-Connector	SC-3 (BAG 10 PCS)



Connection diagram

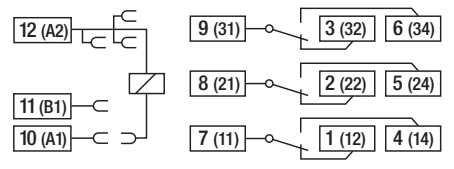

Dimensions [mm]

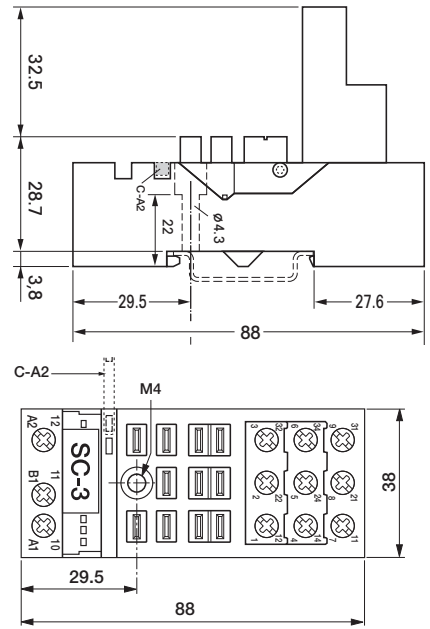

Technical approvals, conformities



4.0 Sockets
S5-L, S5-P

PCB Socket for 11-pin Relays

Rated Load	16 A / 400 V
Specifications	
Rated impulse withstand voltage	2.5 kV rms / 1 min
- Pin / Pin	
Ambient temperature operation/storage	-4060 °C / -40 ... 80 °C (no ice)
Weight	20g
Optional Accessories	
Retaining spring, steel	S5-CL for C5 / C5x Relays

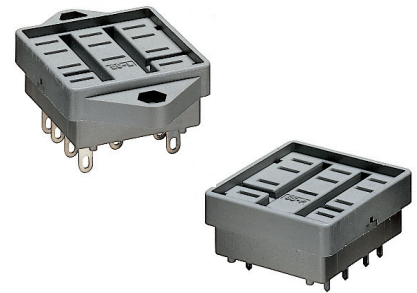

Printed circuit lay-out [mm]

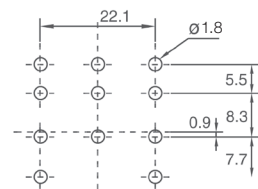

Dimensions [mm]

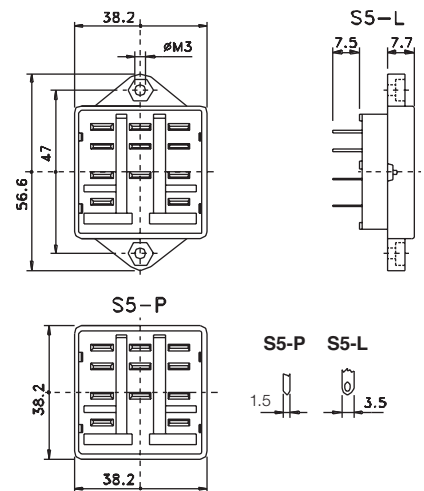

4.0 Sockets

4

Technical approvals, conformities



Rated Load **16 A / 400 V**

Specifications

Rated impulse withstand voltage	4 kV rms / 1 min
- All terminals / DIN rail	4 kV rms / 1 min
- Terminal / Terminal	
Cross-section of connecting wire	
- Single-wire	1 x 6 mm ² / AWG 10, 2 x 2.5 mm ² / AWG 14
- Multi wire	1 x 6 mm ² / AWG 10, 2 x 1.5 mm ² / AWG 16
Nominal screw torque	1 Nm
Screw dimensions	M3.5 Pozi slot
Mounting	TS-35 or Back Panel Mounting
Ambient temperature operation / storage	-40 ... 60° C / -40 ... 80° C (no ice)
Weight	92g

Integrated Accessories

A2-Connector	C-A2
Retaining clip, plastic	S5M-CP for C5 / C5x Relays
A1-, B1-Connector	SC-3

Optional Accessories

Retaining Clip, steel	HF-32 (BAG 10 PCS) for C5 / C5x Relays
A2-Connector	C-A2 (BAG 5 PCS), C-A2 (BAG 50 PCS)
A1-, B1-Connector	SC-3 (BAG 10 PCS)

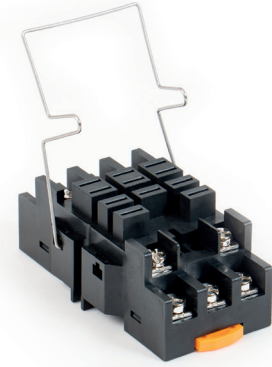

Anschlusschema

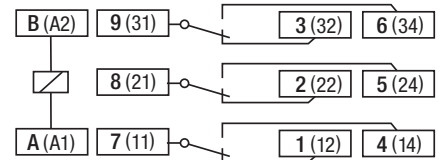

Abmessungen [mm]

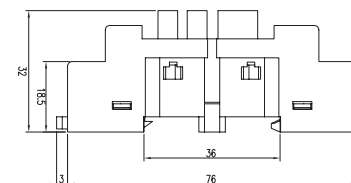
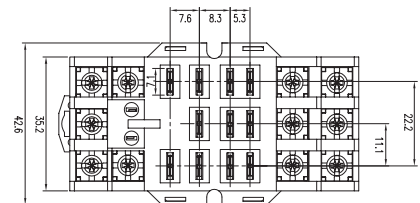

Technische Zulassungen, Konformitäten



S7-C

Socket for 8-pin Relays

Rated Load **10A, 16A for 1-pole / 250 V**

Specifications

Rated impulse withstand voltage	2.5 kV rms / 1 min
- All terminals / DIN rail	2.5 kV rms / 1 min
- Terminal / Terminal	2.5 kV rms / 1 min
Cross-section of connecting wire	
- Single-wire	4 mm ² / AWG 12, 2 x 1.5 mm ² / AWG 16
- Multi wire	2.5 mm ² / AWG 14, 2 x 1 mm ² / AWG 18
Nominal screw torque	0.7 Nm
Screw dimensions	M3 Pozi slot
Mounting	TS-35 or Back Panel Mounting
Ambient temperature operation/storage	-40...60°C (50°C for 16A)/-40...80°C (no ice)
Weight	37g

Included Accessories

Retaining clip, plastic CP-07B for C7 / C7x Relays

Optional Accessories

Retaining clip, plastic CP-07B (BAG 50 PCS) for C7 / C7x Relays
 A2-Connector S7-BB (BAG 20 PCS)
 Panel Adapter S9-G

Please Note:

This socket replaces former socket S7-M and S7-16

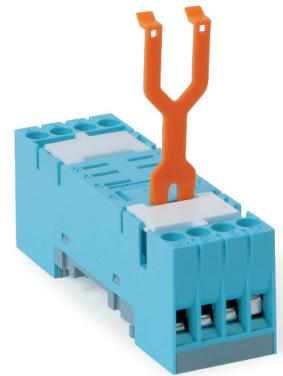

Connection diagram

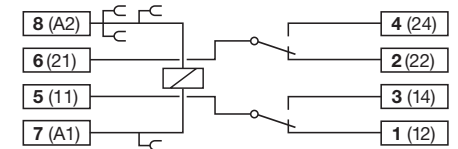

Dimensions [mm]

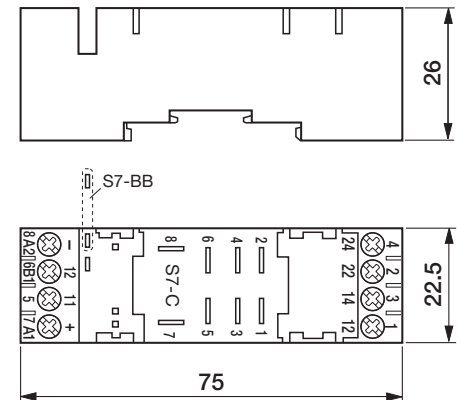

Technical approvals, conformities



S7-10

Socket for 8-pin Relays

Rated Load	10 A / 250 V
Specifications	
Rated impulse withstand voltage	2.5 kV rms / 1 min
- All terminals / DIN rail	2.5 kV rms / 1 min
- Terminal / Terminal	
Cross-section of connecting wire	
- Single-wire	4 mm ² / AWG 12, 2 x 2.5 mm ² / AWG 14
- Multi wire	0.34 mm ² / AWG 22 - 2.5 mm ² / AWG 14
Nominal screw torque	0.7 Nm
Screw dimensions	M3 Pozi slot
Mounting	TS-35 or Back Panel Mounting
Ambient temperature operation/storage	-40...60 °C / -40 ... 80 °C (no ice)
Weight	38g

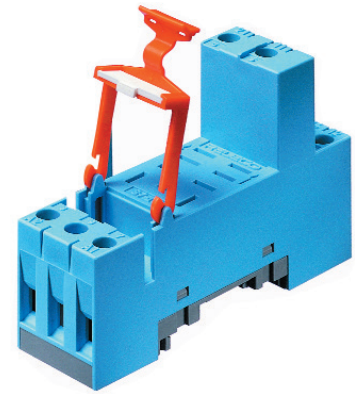

Included Accessories	
Retaining clip, plastic	S9-C for C7 / C7x Relays
Optional Accessories	
Retaining clip, plastic	S9-C (BAG 10 PCS) for C7 / C7x Relays
A2-Connector	S7-BB (BAG 20 PCS)
Panel Adapter	S9-G (BAG 10 PCS)



Connection diagram

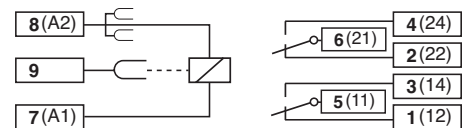

Dimensions [mm]

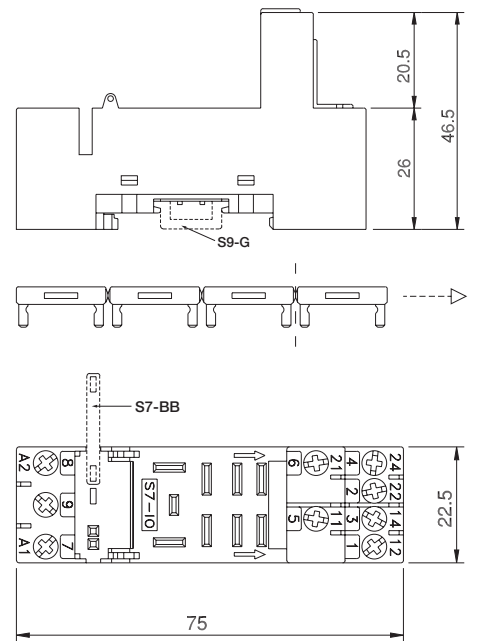

Technical approvals, conformities



S7-P

PCB Socket for 8-pin Relays

Rated Load	10 A / 250 V
Specifications	
Rated impulse withstand voltage	2.5 kV rms / 1 min
- Pin / Pin	-4060 °C / -40 ... 80 °C (no ice)
Ambient temperature operation/storage	-4060 °C / -40 ... 80 °C (no ice)
Weight	10g
Included Accessories	
Retaining clip, plastic	CP-07B for C7 / C7x Relays
Optional Accessories	
Retaining clip, plastic	CP-07B (BAG 50 PCS) for C7 / C7x Relays

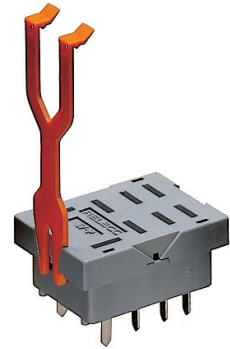

Printed circuit lay-out [mm]

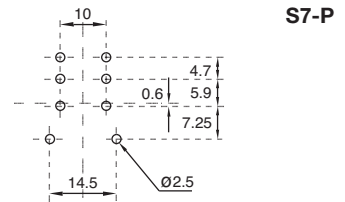

Dimensions [mm]

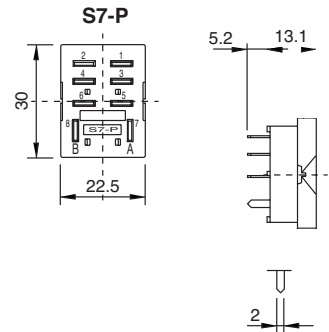

4.0 Sockets

4

Technical approvals, conformities



S9-M

Socket for 14-pin Relays

Rated Load	6 A / 250 V
-------------------	--------------------

Specifications	
Rated impulse withstand voltage	2.5 kV rms / 1 min
- All terminals / DIN rail	2.5 kV rms / 1 min
- Terminal / Terminal	
Cross-section of connecting wire	
- Single-wire	4 mm ² / AWG 12 or 2 x 2.5 mm ² / AWG 14
- Multi-wire	0.34mm ² / 22 - 2.5 mm ² / AWG 14
Nominal screw torque	0.7 Nm
Screw dimensions	M3 Pozi slot
Mounting	TS-35 or Back Panel Mounting
Ambient temperature operation/storage	-40 ... 60 °C / -40 ... 80 °C (no ice)
Weight	54 g

Included Accessories	
Retaining clip, plastic	S9-C for C9 / C9x Relays

Optional Accessories	
Retaining clip, plastic	S9 (BAG 10 PCS) for C9 / C9x Relays
Panel Adapter	S9-G (BAG 10 PCS)
Bridge Bar	S9M-V1 (BAG 5 PCS)
Bridge Bar	S9M-V4 (BAG 5 PCS)
Bridge Bar	S9M-BX (BAG 5 PCS)

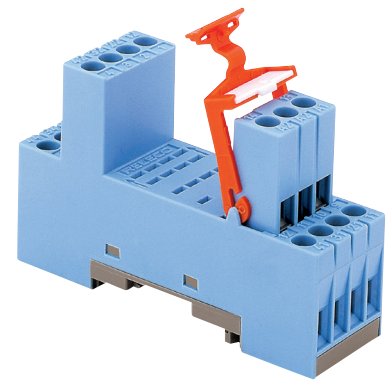

Connection diagram

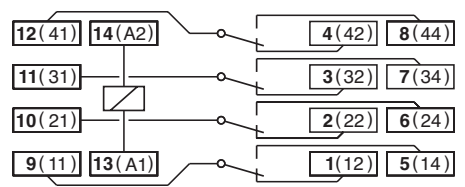

Dimensions [mm]

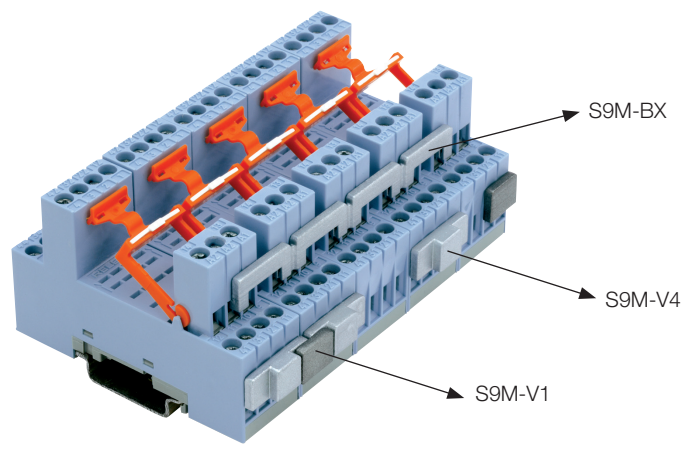
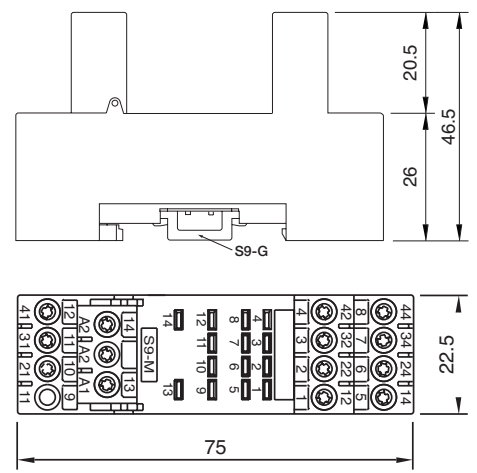

Technical approvals, conformities



S9-P

PCB Socket for 14-pin Relays

Rated Load	6 A / 150 V
Specifications	
Rated impulse withstand voltage	1.5 kV rms / 1 min
- Pin / Pin	
Ambient temperature operation/storage	-4060 °C /-40 ... 80 °C (no ice)
Weight	12g
Included Accessories	
Retaining clip, plastic	CP-07B for C9 / C9x Relays
Optional Accessories	
Retaining clip, plastic	CP-07B (BAG 50 PCS) for C9 / C9x Relays

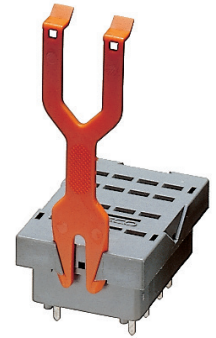

Printed circuit lay-out [mm]

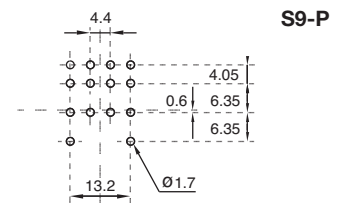

Dimensions [mm]

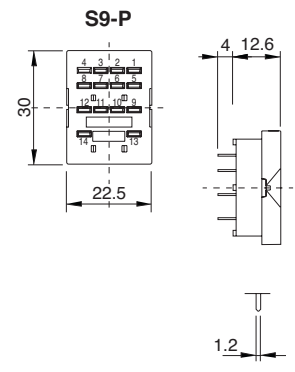

This print socket must be used in pollution degree 2 environment only, hence office, laboratory, household or similar. It is not suitable for industry environment (pollution degree 3).

Maximum voltage between two separate circuits on neighbouring contacts: 150 V
Not permitted: 24 V DC next to 230 V AC, 230 V AC next to neutral, 230 V AC next to 230 V AC of different phases
Permitted: 230 V AC next to 230 V AC same phase

Technical approvals, conformities



Rated Load	10 A / 250 V
Specifications	
Rated impulse withstand voltage	5 kV rms / 1 min
- All terminals / DIN rail	2.5 kV rms / 1 min
- Contact / Terminals	5 kV rms / 1 min
- Contact / Coil terminals	5 kV rms / 1 min
Cross-section of connecting wire	
- Single-wire	4 mm ² / AWG 12 or 2 x 2.5 mm ² / AWG 14
- Multi-wire	0.34mm ² / 22 - 2.5 mm ² / AWG 14
Nominal screw torque	0.7 Nm
Screw dimensions	M3 Pozi slot
Mounting	TS-35 or Back Panel Mounting
Ambient temperature operation/storage	-40...60 °C / -40 ... 80 °C (no ice)
Weight	23g

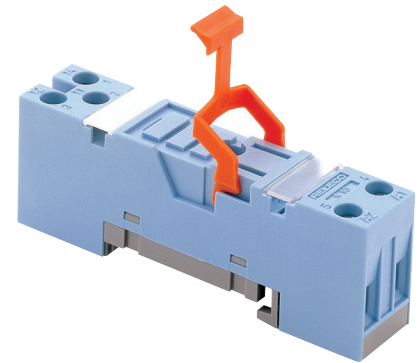

Included Accessories	
Retaining Clip, plastic	S10-C for C10 / C10x Relays
Optional Accessories	
Retaining clip, plastic	S10-C / CP-17B (BAG 10 PCS) for C10 / C10x
Bridge bar	S10-BB (BAG 20 PCS)



Connection diagram

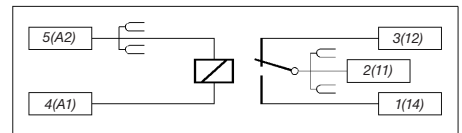

Dimensions [mm]

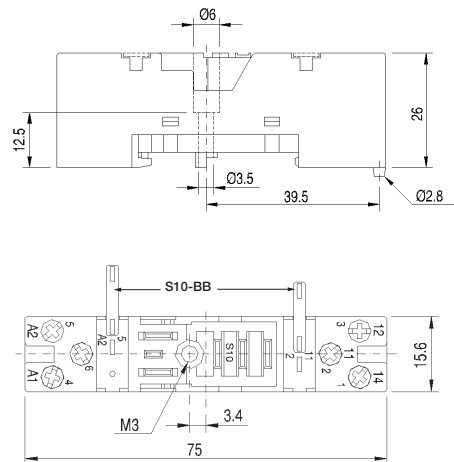

Technical approvals, conformities



S10-P

PCB Socket for 5-pin Relays

Rated Load	10 A / 250 V
Specifications	
Rated impulse withstand voltage	5 kV rms / 1 min
- Pin / Pin	-40 ... 60 °C / -40 ... 80 °C (no ice)
Ambient temperature operation/storage	-40 ... 60 °C / -40 ... 80 °C (no ice)
Weight	7g
Included Accessories	
Retaining clip, plastic	CP-24B for C10 / C10x Relays



Printed circuit lay-out [mm]

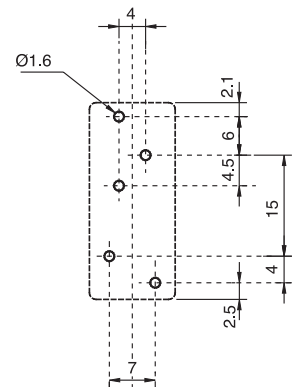

Dimensions [mm]

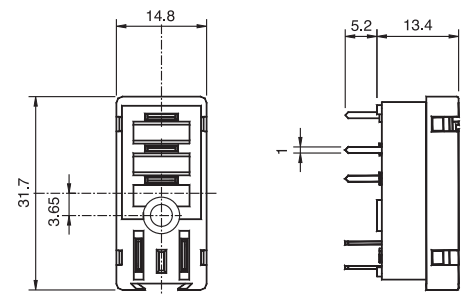

Technical approvals, conformities



S12

Socket for 8-pin Relays

Rated Load	5 A / 250 V
Specifications	
Rated impulse withstand voltage	5 kV rms / 1 min
- All terminals / DIN rail	2.5 kV rms / 1 min
- Contact / Terminals	5 kV rms / 1 min
- Contacts / Coil terminals	5 kV rms / 1 min
Cross-section of connecting wire	
- Single-wire	4 mm ² / AWG 12 or 2 x 2.5 mm ² / AWG 14
- Multi-wire	0.34mm ² / 22 - 2.5 mm ² / AWG 14
Nominal screw torque	0.7 Nm
Screw dimensions	M3 Pozi slot
Mounting	TS-35 or Back Panel Mounting
Ambient temperature operation/storage	-40 ... 60 °C / -40 ... 80 °C (no ice)
Weight	31g

Included Accessories	
Retaining Clip, plastic	S10-C for C12 / C12x Relays

Optional Accessories	
Retaining Clip, plastic	S10-C / CP-17B (BAG 10 PCS) for C12 / C12x Relays
A2-Connector grey	B20-G (BAG 5 PCS)
A2-Connector red	B20-R (BAG 5 PCS)
A2-Connector blue	B20-A (BAG 5 PCS)
Bridge Bar twofold grey	V10-G (BAG 5 PCS)
Bridge Bar twofold red	V10-RC (BAG 5 PCS)
Bridge Bar twofold blue	V10-AC (BAG 5 PCS)
Bridge Bar fourfold grey	V40-G (BAG 5 PCS)
Bridge Bar fourfold red	V40-R (BAG 5 PCS)
Bridge Bar fourfold blue	V40-AC (BAG 5 PCS)

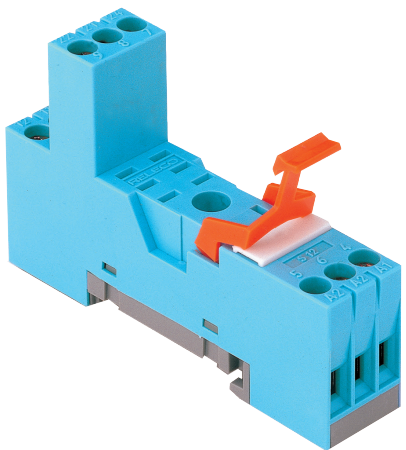

Connection diagram

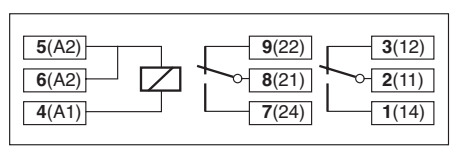

Dimensions [mm]

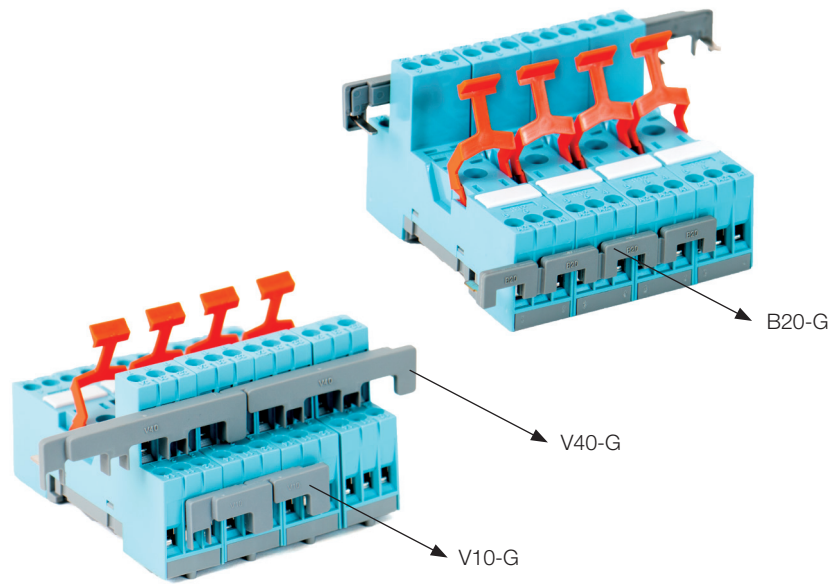
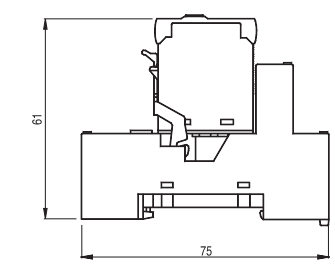
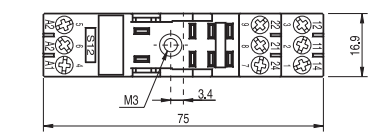
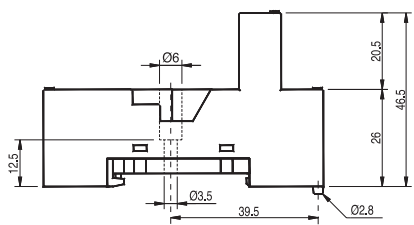

Technical approvals, conformities



S12-P

PCB Socket for 8-pin Relays

Rated Load	5 A / 250 V
Specifications	
Rated impulse withstand voltage	
- Pin / Pole	3 kV rms / 1 min
- Coil / contact terminals	5 kV rms / 1 min
Weight	7g
Included Accessories	
Retaining clip, plastic	CP-24B for C12 / C12x Relays

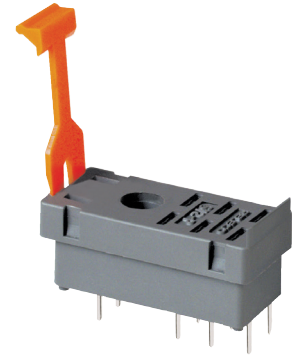

Printed circuit lay-out [mm]

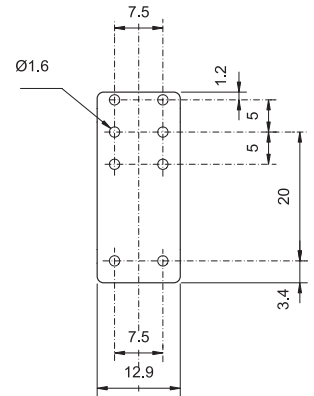

Dimensions [mm]

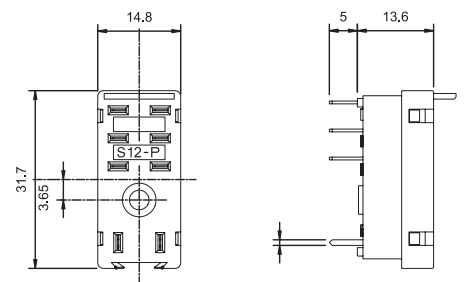

Technical approvals, conformities



S16-M

Socket for 8-pin Relays

Rated Load	10 A / 300 V
Specifications	
Rated impulse withstand voltage	3 kV rms / 1 min
- All terminals / DIN rail	3 kV rms / 1 min
- Terminal / Terminal	3 kV rms / 1 min
- Terminal / Coil	3 kV rms / 1 min
Cross-section of connecting wire	
- Single-wire	1 × 0.5 mm ² / AWG 20
- Multi-wire	1 × 2.5 mm ² / AWG 14 or 2 × 1.0 mm ² / AWG 18
Nominal screw torque	0.7 Nm
Screw dimensions	M3 Pozzi 1 slot 2
Mounting	TS-35 or Back Panel Mounting
Ambient temperature	-40...60 °C / -40 ... 80 °C (no ice)
Weight	42 g



Included Accessories	
Retaining / Ejector clip, plastic	CP-16
Optional Accessories (modules)	
Free wheeling diode	RD16/DC12-240V
Green LED & free wheeling diode, 6-24VDC	RDL16/DC6-24V
Green LED & free wheeling diode, 24-60VDC	RDL16/DC24-60V
Green LED & free wheeling diode, 110-240VDC	RDL16/DC110-240V
Green LED, 6-24V AC/DC	RL16/UC6-24V
Green LED, 24-60V AC/DC	RL16/UC24-60V
Green LED, 110-240V AC/DC	RL16/UC110-240V
RC-Network 6-24V	RC16/UC6-24V
RC-Network 24-60V	RC16/UC24-60V
RC-Network 110-240V	RC16/UC110-240V



Connection diagram

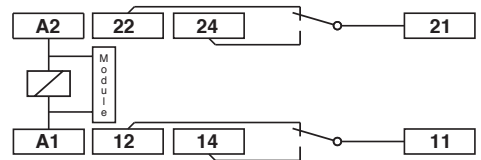

Dimensions [mm]

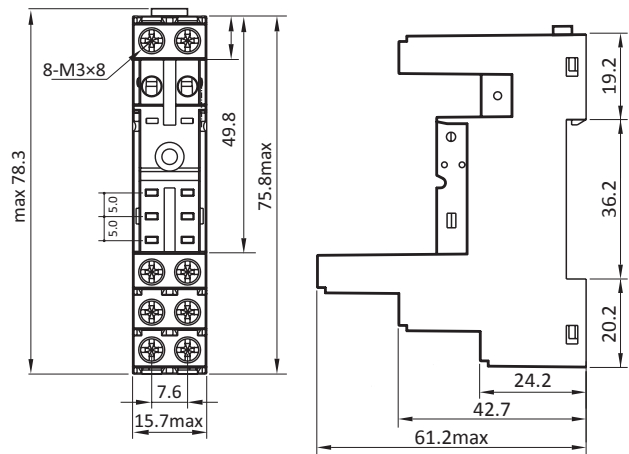

Technical approvals, conformities



S18-M

Socket for 8-pin Relays

Rated Load	10 A / 300 V
Specifications	
Rated impulse withstand voltage	3 kV rms / 1 min
- All terminals / DIN rail	3 kV rms / 1 min
- Terminal / Terminal	3 kV rms / 1 min
- Terminal / Coil	3 kV rms / 1 min
Cross-section of connecting wire	
- Single-wire	1 × 0.5 mm ² / AWG 20
- Multi-wire	1 × 2.5 mm ² / AWG 14 or 2 × 1.0 mm ² / AWG 18
Nominal screw torque	0.7 Nm
Screw dimensions	M3 Pozi 1 slot 2
Mounting	TS-35 or Back Panel Mounting
Ambient temperature	-40 ... 60 °C / -40 ... 80 °C (no ice)
Weight	42 g

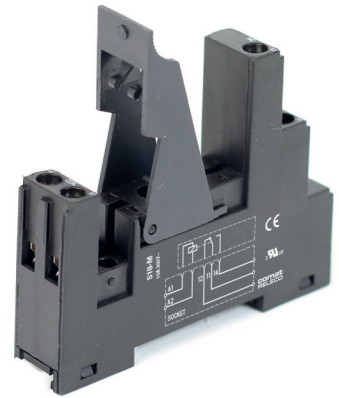

Included Accessories	
Retaining / Ejector clip, plastic	CP-16

Optional Accessories (modules)	
Free wheeling diode	RD16/DC12-240V
Green LED & free wheeling diode, 6-24VDC	RDL16/DC6-24V
Green LED & free wheeling diode, 24-60VDC	RDL16/DC24-60V
Green LED & free wheeling diode, 110-240VDC	RDL16/DC110-240V
Green LED, 6-24V AC/DC	RL16/UC6-24V
Green LED, 24-60V AC/DC	RL16/UC24-60V
Green LED, 110-240V AC/DC	RL16/UC110-240V
RC-Network 6-24V	RC16/UC6-24V
RC-Network 24-60V	RC16/UC24-60V
RC-Network 110-240V	RC16/UC110-240V



Connection diagram

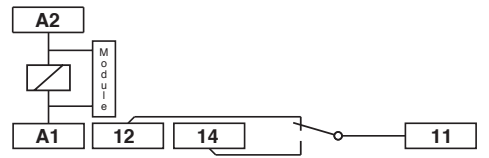

Dimensions [mm]

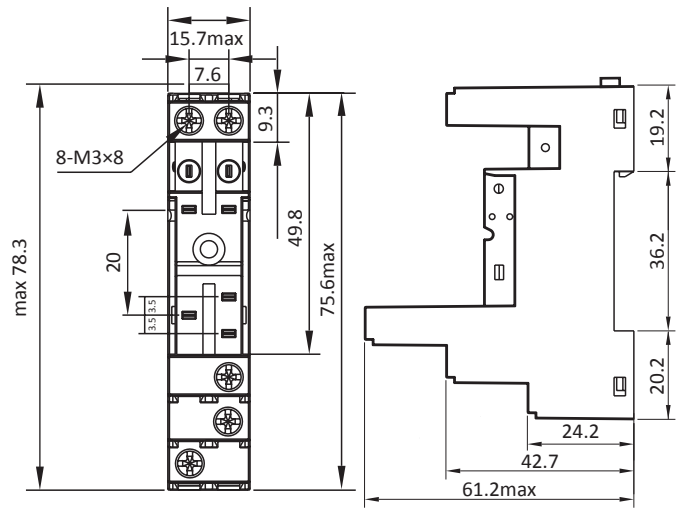

Technical approvals, conformities



4.0 Sockets

4

TURCK



28 subsidiaries and over
60 representations worldwide!

www.turck.com

Printed in USA

©2018 by Turck Inc. All rights reserved. No part of the
publication may be reproduced without written permission.

B1201 A 09/18