



# MINI-BEAM® SM312D

Self-contained DC-operated Diffuse Mode Sensors



- Compact, modulated, self-contained diffuse proximity mode sensors for 10-30V dc operation
- Range to 380 mm (15") (referenced to 90% reflectance white test card)
- Switch-selectable for light operate or dark operate
- Includes Banner's exclusive **AID™** alignment system\*
- Highly repeatable 1 millisecond response
- Both sourcing and sinking outputs (150 mA max. each); continuous overload and short-circuit protected
- Rugged, epoxy-encapsulated construction: meets NEMA standards 1, 2, 3, 3S, 4, 4X, 6, 12 and 13; IEC IP67
- Physically and electrically interchangeable with 18 mm barrel-type photoelectrics

\*US patent number 4356393

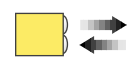

Infrared, 880 nm

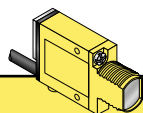

## MINI-BEAM Diffuse Mode Models

Models	Range	Cable*	Supply Voltage	Output Type	Excess Gain	Beam Pattern
					Performance based on 90% reflectance white test card	
SM312D SM312DQD	380 mm (15")	2 m (6.5') 4-Pin Euro QD	10-30V dc	Bipolar NPN/PNP		

**\*Notes:**

- 9 m (30') cables are available by adding suffix "W/30" to the model number of any cabled sensor (e.g., **SM312D W/30**).
- A 150 mm (6") long pigtail cable with attached QD connector is available by adding suffix "QDP" to the model number of any MINI-BEAM sensor (e.g., **SM312DQDP**). See page 5 for more information.
- A model with a QD connector requires an accessory mating cable. See page 8 for more information.
- May be ordered with 0.3 millisecond on/off response by adding suffix "MHS" to the model numbers (e.g., **SM312DMHS**). This modification reduces sensing range (and excess gain).

## MINI-BEAM Installation and Alignment

Proper operation of the SM312D sensor requires that it be mounted securely and aligned properly. Excessive movement or vibration can result in intermittent or false operation caused by loss of alignment. For best results, final-mount the SM312D in an 18mm-hole by its threaded barrel or use a mounting bracket (see page 6).

1) Begin with the sensor at the desired distance from the object to be sensed, and at the approximate position where it will be mounted. The background should be as far behind the object as possible (at least three times the distance of the sensor from the object), and as dark a color as possible compared to the object. Ideally, the object should present its largest reflective surface to the sensor.

2) Apply power to the sensor, and advance the 15-turn GAIN control to maximum (clockwise end of rotation). The GAIN control is clutched at both ends to avoid damage, and will “free-wheel” when either end point is reached.

If the sensor is “seeing” its reflected light, the sensor alignment LED should be “on”. Move the sensor up-down-right-left (include angular rotation) to obtain the fastest receiver LED pulse rate. If a pulse is not observable (too fast to count), reduce the GAIN control (counterclockwise rotation) to obtain a countable pulse rate.

3) Repeat the alignment motions after each GAIN reduction. When you have found the sensor orientation that produces the fastest pulse rate, mount the sensor solidly in that position. Increase the receiver GAIN to maximum. Test the system by removing the object from the sensing position. The receiver LED indicator should go “off”. If the LED indicator does not go “off”, the sensor is reacting to light reflected from a background surface. Reduce the GAIN setting until the alignment indicator goes “off”, plus two additional full turns. Again place the object in the sensing position. If the alignment indicator does not come “on”, the sensor is receiving as much or more light energy from the background as from the object. Consider the following alternatives:

- move the sensor closer to the object and reduce the sensitivity (GAIN);
- reduce background reflectivity by painting the background with flat-black paint, or by scuffing the background or cutting a hole through it;
- tilt the sensor or the background so that the sensing beam is not perpendicular to the background.

**\* Note regarding Light/Dark operate switch:**

- Turn switch *fully* clockwise for light operate (sensor outputs conduct when sensing light is received)
- Turn switch *fully* counterclockwise for dark operate (sensor outputs conduct when sensing light is not received)

### Diffuse Mode Alignment

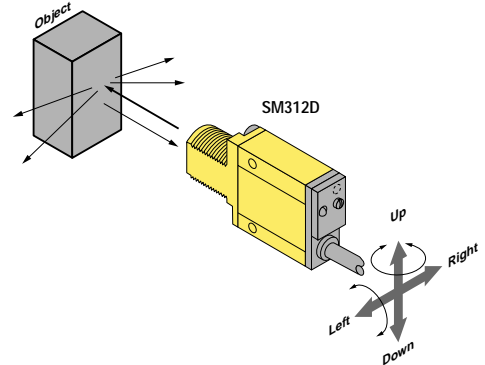

### SM312D

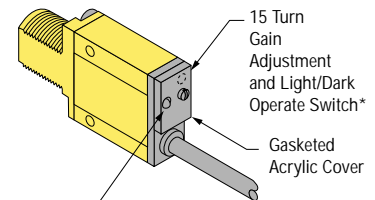

“AID” Indicator LED Lights when the sensor sees its own modulated light and pulses at a rate proportional to the strength of the received light signal.

MINI-BEAM DC Sensor Specifications	
Supply Voltage and Current	10 to 30V dc (10% maximum ripple) at less than 25 mA (exclusive of load)
Supply Protection Circuitry	Protected against reverse polarity and transient voltages
Output Configuration	Bipolar: One current sourcing (PNP) and one current sinking (NPN) open-collector transistor
Output Rating	150mA maximum each output at 25°C, derated to 100 mA at 70°C (derate ≈1 mA per °C) <b>Off-state leakage current</b> less than 1 microamp <b>Output saturation voltage</b> (PNP output) less than 1 volt at 10 mA and less than 2 volts at 150 mA <b>Output saturation voltage</b> (NPN output) less than 200 millivolts at 10 mA and less than 1 volt at 150 mA
Output Protection Circuitry	Protected against false pulse on power-up and continuous overload or short-circuit of outputs
Output Response Time	Sensors will respond to either a "light" or a "dark" signal of 1 millisecond or longer duration, 500 Hz max. 0.3 millisecond response modification is available. See note below. 100 millisecond delay on power-up: outputs do not conduct during this time.  NOTE: DC MINI-BEAMS may be ordered with 0.3 millisecond on/off response by adding suffix "MHS" to the model numbers (e.g. - SM312DMHS). This modification reduces sensing range (and excess gain).
Repeatability	0.3 milliseconds. Response time and repeatability specifications are independent of signal strength.
Adjustments	LIGHT/DARK OPERATE select switch, and 15-turn slotted brass screw GAIN (sensitivity) adjustment potentiometer (clutched at both ends of travel). Both controls are located on rear panel of sensor and protected by a gasketed, clear acrylic cover.
Indicators	Exclusive, patented Alignment Indicating Device system (AID™, US patent #4356393) lights a rear-panel mounted red LED indicator whenever the sensor sees a "light" condition, with a superimposed pulse rate proportional to the light signal strength (the stronger the signal, the faster the pulse rate).
Construction	Reinforced PBT thermoplastic polyester housing, totally encapsulated, o-ring sealing, acrylic lenses, and stainless steel screws.
Environmental Rating	Meets NEMA standards 1, 2, 3, 3S, 4, 4X, 6, 12, and 13; IEC IP67
Connections	PVC-jacketed 4-conductor 2 m (6.5 ft) or 9 m (30 ft) cables, or 4-pin euro-style quick disconnect (QD) fitting are available. QD cables are ordered separately. See page 8.
Operating Temperature	<b>Temperature:</b> -20° to +70°C (-4° to +158°F) <b>Maximum relative humidity:</b> 90% at 50°C (non-condensing)
Application Notes	The NPN (current sinking) output of dc MINI-BEAM sensors is directly compatible as an input to Banner logic modules, including all non-amplified MAXI-AMP and MICRO-AMP modules. MINI-BEAMS are TTL compatible.
Certifications	

## MINI-BEAM DC Hookup Diagrams

### DC Sensors with Attached Cable

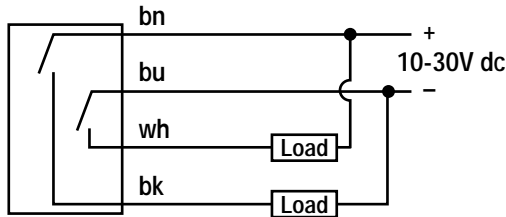

### DC Sensors with Quick Disconnect (4-Pin Euro-Style)

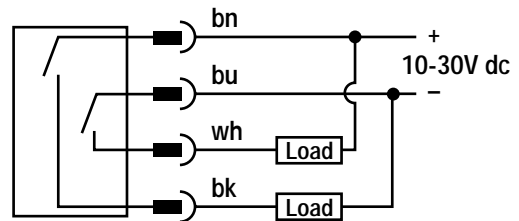

### 4-Pin Euro-Style Pin-out (Cable Connector Shown)

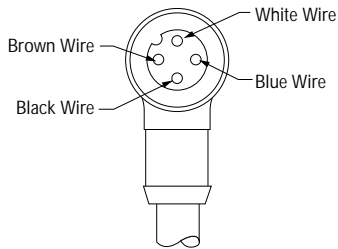

### Quick Disconnect (QD) Option

DC MINI-BEAM sensors are sold with either a 2 m (6.5') or a 9 m (30') attached PVC-covered cable, or with a 4-pin Euro-style QD cable fitting.

DC QD sensors are identified by the letters "QD" in their model number suffix. For more information on mating QD cables, see page 8.

## MINI-BEAM Dimensions

### MINI-BEAM DC Sensor with Integral Cable

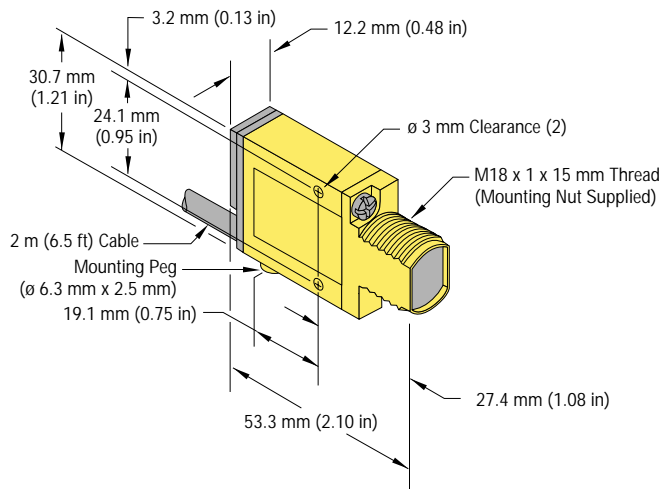

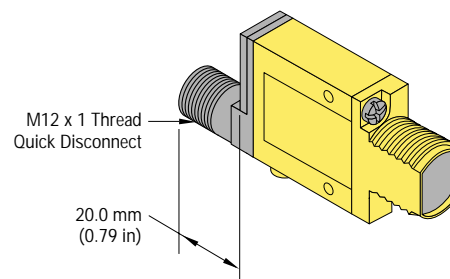

### MINI-BEAM DC Sensor with Quick-Disconnect



MINI-BEAM Modifications			
Model Suffix	Modification	Description	Example of Model Number
W/30	9 meter (30') cable	All MINI-BEAM sensors may be ordered with an integral 9 m (30') cable in place of the standard 2 m (6.5') cable	SM312D W/30
MHS	Modified for High Speed	Standard dc MINI-BEAM sensors with 1 millisecond output response may be modified for 0.3 millisecond (300 μs) response. NOTE: Faster response comes at the expense of lower excess gain. Also, operating temperature range becomes -20° to +50°C (-4° to +122°F)	SM312DMHS
QDP	Pigtail Quick Disconnect	All MINI-BEAMS may be built with a 150 mm (6") long integral cable which is terminated with the appropriate QD connector.	SM312DQDP

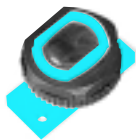

Replacement Lens Assemblies		
MINI-BEAM lens assemblies are field-replaceable.		
Model	Description	
UC-300L	Replacement lens for SM312D	

Right-Angle Reflectors		
MINI-BEAM right-angle reflectors are useful for tight sensing locations. NOTE: These reflectors significantly decrease excess gain.		
Model	Description	
RAR-300SM	<ul style="list-style-type: none"> <li>Side mount reflector</li> <li>Profile dimension of 14 mm (0.56") in the direction of the scan</li> </ul>	
RAR-300FM	<ul style="list-style-type: none"> <li>Front mount reflector that attaches directly to the threaded barrel of most MINI-BEAMS</li> <li>Profile dimension of 34 mm (1.35") in the direction of the scan</li> </ul>	

Mounting Brackets			
Model	Description		
SMB312S	Stainless steel 2-axis, side mounting bracket		
SMB312PD	Stainless steel 18 mm barrel-mounting bracket		
SMB312B	Stainless steel 2-axis, bottom mounting bracket		
SMB46L	<ul style="list-style-type: none"> <li>• "L" bracket</li> <li>• 14 ga 316 stainless steel</li> </ul>		

Mounting Brackets			
Model	Description	Dimensions	
SMB46S	<ul style="list-style-type: none"> <li>• "S" bracket</li> <li>• 14 ga 316 stainless steel</li> </ul>	<p>Technical drawing of the SMB46S "S" bracket. Dimensions include: 10 mm (0.4 in), 6 mm (0.2 in), 6 mm (0.2 in), 5 mm (0.2 in), 8 mm (0.3 in), 16 mm (0.6 in), 34 mm (1.3 in), 17 mm (0.7 in), 3.5 mm (0.14 in), 15 mm (0.6 in), <math>\phi 36</math> mm (1.4 in), <math>\phi 6.5</math> mm (0.26 in) (6x), 54 mm (2.1 in), 65 mm (2.6 in), 2 mm (.1 in), 27 mm (1.1 in), and 16 mm (0.6 in).</p>	
SMB46U	<ul style="list-style-type: none"> <li>• "U" bracket</li> <li>• 14 ga 316 stainless steel</li> </ul>	<p>Technical drawing of the SMB46U "U" bracket. Dimensions include: 17 mm (0.7 in), 13 mm (0.5 in), 6 mm (0.2 in), 6 mm (0.2 in), 5 mm (0.2 in), 8 mm (0.3 in), 16 mm (0.6 in), 34 mm (1.3 in), 17 mm (0.7 in), 3.5 mm (0.14 in), 15 mm (0.6 in), <math>\phi 36</math> mm (1.4 in), <math>\phi 6.5</math> mm (0.26 in) (6x), 54 mm (2.1 in), 65 mm (2.6 in), 2 mm (.1 in), 27 mm (1.1 in), 70 mm (2.8 in), and 16 mm (0.6 in).</p>	
SMB18C	<ul style="list-style-type: none"> <li>• 18 mm split clamp black PBT thermoplastic polyester bracket</li> <li>• Stainless steel mounting hardware included</li> </ul>	<p>Technical drawing of the SMB18C split clamp bracket. Dimensions include: 40.0 mm (1.60 in), 42.4 mm (1.67 in), 14.0 mm (0.55 in), 30.0 mm (1.18 in), 21.1 mm (0.83 in), 2.5 mm (0.10 in), 13 mm (0.5 in), and 10.6 mm (0.42 in). Hardware includes a Nut Plate and M5 x 0.8 x 60 mm Screw (2).</p>	
SMB18SF	<ul style="list-style-type: none"> <li>• 18 mm swivel bracket</li> <li>• Black thermoplastic polyester</li> <li>• Includes stainless steel swivel locking hardware</li> </ul>	<p>Technical drawing of the SMB18SF swivel bracket. Dimensions include: 36.0 mm (1.42 in), 42.0 mm (1.65 in), 50.8 mm (2.00 in), 10.6 mm (0.42 in), 22.9 mm (0.9 in), and 25.4 mm (1.00 in). Hardware includes M18 x 1 internal thread.</p>	

# MINI-BEAM<sup>®</sup> Sensors SM312D

## Extension Cables (without connectors)

The following cables are available for extending the length of existing sensor cable. These are 30 m (100') lengths of MINI-BEAM cable. This cable may be spliced to existing cable. Connectors, if used, must be customer-supplied.

Model	Type	Used with:
EC312-100	4-conductor	All MINI-BEAM SM312 dc models

## Euro-Style Quick-Disconnect Cables

**Cable:** PVC jacket, polyurethane connector body, nickel-plated brass coupling nut  
**Conductors:** 22 or 20 AWG high-flex stranded, PVC insulation, gold-plated contacts  
**Temperature:** -40° to +90°C (-40° to +194°F)  
**Voltage Rating:** 250V ac/300V dc



Style	Model	Length	Dimensions:	Pin-out
4-Pin Straight	MQDC-406 MQDC-415 MQDC-430	2 m (6.5') 5 m (15') 9 m (30')		
4-Pin Right-angle	MQDC-406RA MQDC-415RA MQDC-430RA	2 m (6.5') 5 m (15') 9 m (30')		



### WARNING . . . Not To Be Used for Personnel Protection

Never use this product as a sensing device for personnel protection. Doing so could lead to serious injury or death.

This product does NOT include the self-checking redundant circuitry necessary to allow its use in personnel safety applications. A sensor failure or malfunction can cause either an energized or de-energized sensor output condition. Consult your current Banner Safety Products catalog for safety products which meet OSHA, ANSI and IEC standards for personnel protection.

**WARRANTY:** Banner Engineering Corp. warrants its products to be free from defects for one year. Banner Engineering Corp. will repair or replace, free of charge, any product of its manufacture found to be defective at the time it is returned to the factory during the warranty period. This warranty does not cover damage or liability for the improper application of Banner products. This warranty is in lieu of any other warranty either expressed or implied.





# MINI-BEAM® SM312D

Self-contained DC-operated Diffuse Mode Sensors



- Compact, modulated, self-contained diffuse proximity mode sensors for 10-30V dc operation
- Range to 380 mm (15") (referenced to 90% reflectance white test card)
- Switch-selectable for light operate or dark operate
- Includes Banner's exclusive **AID™** alignment system\*
- Highly repeatable 1 millisecond response
- Both sourcing and sinking outputs (150 mA max. each); continuous overload and short-circuit protected
- Rugged, epoxy-encapsulated construction: meets NEMA standards 1, 2, 3, 3S, 4, 4X, 6, 12 and 13; IEC IP67
- Physically and electrically interchangeable with 18 mm barrel-type photoelectrics

\*US patent number 4356393

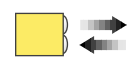

Infrared, 880 nm

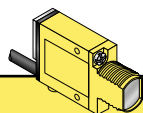

## MINI-BEAM Diffuse Mode Models

Models	Range	Cable*	Supply Voltage	Output Type	Excess Gain	Beam Pattern
					Performance based on 90% reflectance white test card	
SM312D SM312DQD	380 mm (15")	2 m (6.5') 4-Pin Euro QD	10-30V dc	Bipolar NPN/PNP		

**\*Notes:**

- 9 m (30') cables are available by adding suffix "W/30" to the model number of any cabled sensor (e.g., **SM312D W/30**).
- A 150 mm (6") long pigtail cable with attached QD connector is available by adding suffix "QDP" to the model number of any MINI-BEAM sensor (e.g., **SM312DQDP**). See page 5 for more information.
- A model with a QD connector requires an accessory mating cable. See page 8 for more information.
- May be ordered with 0.3 millisecond on/off response by adding suffix "MHS" to the model numbers (e.g., **SM312DMHS**). This modification reduces sensing range (and excess gain).

## MINI-BEAM Installation and Alignment

Proper operation of the SM312D sensor requires that it be mounted securely and aligned properly. Excessive movement or vibration can result in intermittent or false operation caused by loss of alignment. For best results, final-mount the SM312D in an 18mm-hole by its threaded barrel or use a mounting bracket (see page 6).

- 1) Begin with the sensor at the desired distance from the object to be sensed, and at the approximate position where it will be mounted. The background should be as far behind the object as possible (at least three times the distance of the sensor from the object), and as dark a color as possible compared to the object. Ideally, the object should present its largest reflective surface to the sensor.
- 2) Apply power to the sensor, and advance the 15-turn GAIN control to maximum (clockwise end of rotation). The GAIN control is clutched at both ends to avoid damage, and will “free-wheel” when either end point is reached.

If the sensor is “seeing” its reflected light, the sensor alignment LED should be “on”. Move the sensor up-down-right-left (include angular rotation) to obtain the fastest receiver LED pulse rate. If a pulse is not observable (too fast to count), reduce the GAIN control (counterclockwise rotation) to obtain a countable pulse rate.

- 3) Repeat the alignment motions after each GAIN reduction. When you have found the sensor orientation that produces the fastest pulse rate, mount the sensor solidly in that position. Increase the receiver GAIN to maximum. Test the system by removing the object from the sensing position. The receiver LED indicator should go “off”. If the LED indicator does not go “off”, the sensor is reacting to light reflected from a background surface. Reduce the GAIN setting until the alignment indicator goes “off”, plus two additional full turns. Again place the object in the sensing position. If the alignment indicator does not come “on”, the sensor is receiving as much or more light energy from the background as from the object. Consider the following alternatives:

- a) move the sensor closer to the object and reduce the sensitivity (GAIN);
- b) reduce background reflectivity by painting the background with flat-black paint, or by scuffing the background or cutting a hole through it;
- c) tilt the sensor or the background so that the sensing beam is not perpendicular to the background.

**\* Note regarding Light/Dark operate switch:**

- Turn switch *fully* clockwise for light operate (sensor outputs conduct when sensing light is received)
- Turn switch *fully* counterclockwise for dark operate (sensor outputs conduct when sensing light is not received)

### Diffuse Mode Alignment

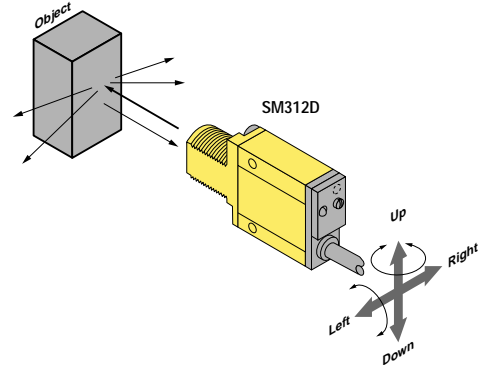

### SM312D

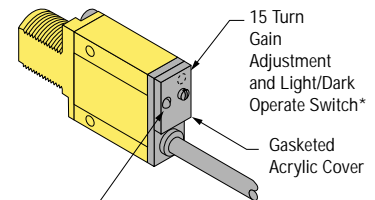

“AID” Indicator LED Lights when the sensor sees its own modulated light and pulses at a rate proportional to the strength of the received light signal.

MINI-BEAM DC Sensor Specifications	
Supply Voltage and Current	10 to 30V dc (10% maximum ripple) at less than 25 mA (exclusive of load)
Supply Protection Circuitry	Protected against reverse polarity and transient voltages
Output Configuration	Bipolar: One current sourcing (PNP) and one current sinking (NPN) open-collector transistor
Output Rating	150mA maximum each output at 25°C, derated to 100 mA at 70°C (derate ≈1 mA per °C) <b>Off-state leakage current</b> less than 1 microamp <b>Output saturation voltage</b> (PNP output) less than 1 volt at 10 mA and less than 2 volts at 150 mA <b>Output saturation voltage</b> (NPN output) less than 200 millivolts at 10 mA and less than 1 volt at 150 mA
Output Protection Circuitry	Protected against false pulse on power-up and continuous overload or short-circuit of outputs
Output Response Time	Sensors will respond to either a "light" or a "dark" signal of 1 millisecond or longer duration, 500 Hz max. 0.3 millisecond response modification is available. See note below. 100 millisecond delay on power-up: outputs do not conduct during this time.  NOTE: DC MINI-BEAMS may be ordered with 0.3 millisecond on/off response by adding suffix "MHS" to the model numbers (e.g. - SM312DMHS). This modification reduces sensing range (and excess gain).
Repeatability	0.3 milliseconds. Response time and repeatability specifications are independent of signal strength.
Adjustments	LIGHT/DARK OPERATE select switch, and 15-turn slotted brass screw GAIN (sensitivity) adjustment potentiometer (clutched at both ends of travel). Both controls are located on rear panel of sensor and protected by a gasketed, clear acrylic cover.
Indicators	Exclusive, patented Alignment Indicating Device system (AID™, US patent #4356393) lights a rear-panel mounted red LED indicator whenever the sensor sees a "light" condition, with a superimposed pulse rate proportional to the light signal strength (the stronger the signal, the faster the pulse rate).
Construction	Reinforced PBT thermoplastic polyester housing, totally encapsulated, o-ring sealing, acrylic lenses, and stainless steel screws.
Environmental Rating	Meets NEMA standards 1, 2, 3, 3S, 4, 4X, 6, 12, and 13; IEC IP67
Connections	PVC-jacketed 4-conductor 2 m (6.5 ft) or 9 m (30 ft) cables, or 4-pin euro-style quick disconnect (QD) fitting are available. QD cables are ordered separately. See page 8.
Operating Temperature	<b>Temperature:</b> -20° to +70°C (-4° to +158°F) <b>Maximum relative humidity:</b> 90% at 50°C (non-condensing)
Application Notes	The NPN (current sinking) output of dc MINI-BEAM sensors is directly compatible as an input to Banner logic modules, including all non-amplified MAXI-AMP and MICRO-AMP modules. MINI-BEAMS are TTL compatible.
Certifications	

## MINI-BEAM DC Hookup Diagrams

### DC Sensors with Attached Cable

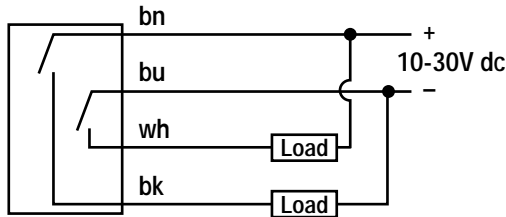

### DC Sensors with Quick Disconnect (4-Pin Euro-Style)

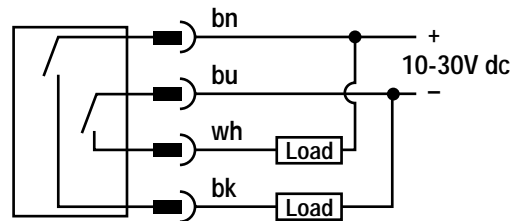

### 4-Pin Euro-Style Pin-out (Cable Connector Shown)

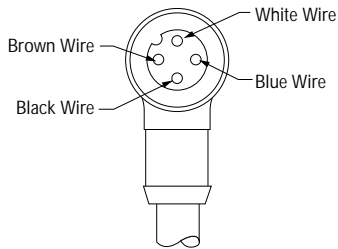

### Quick Disconnect (QD) Option

DC MINI-BEAM sensors are sold with either a 2 m (6.5') or a 9 m (30') attached PVC-covered cable, or with a 4-pin Euro-style QD cable fitting.

DC QD sensors are identified by the letters "QD" in their model number suffix. For more information on mating QD cables, see page 8.

## MINI-BEAM Dimensions

### MINI-BEAM DC Sensor with Integral Cable

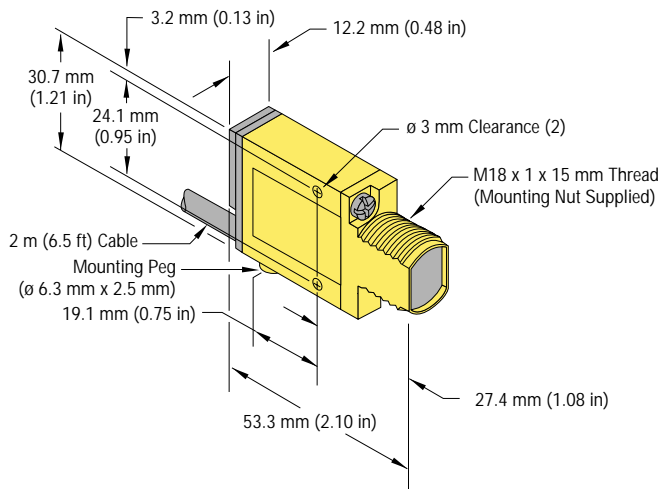

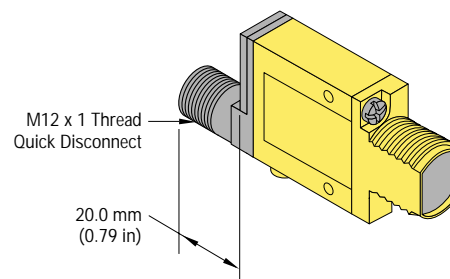

### MINI-BEAM DC Sensor with Quick-Disconnect



MINI-BEAM Modifications			
Model Suffix	Modification	Description	Example of Model Number
W/30	9 meter (30') cable	All MINI-BEAM sensors may be ordered with an integral 9 m (30') cable in place of the standard 2 m (6.5') cable	SM312D W/30
MHS	Modified for High Speed	Standard dc MINI-BEAM sensors with 1 millisecond output response may be modified for 0.3 millisecond (300 μs) response. NOTE: Faster response comes at the expense of lower excess gain. Also, operating temperature range becomes -20° to +50°C (-4° to +122°F)	SM312DMHS
QDP	Pigtail Quick Disconnect	All MINI-BEAMS may be built with a 150 mm (6") long integral cable which is terminated with the appropriate QD connector.	SM312DQDP

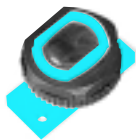

Replacement Lens Assemblies		
MINI-BEAM lens assemblies are field-replaceable.		
Model	Description	
UC-300L	Replacement lens for SM312D	

Right-Angle Reflectors		
MINI-BEAM right-angle reflectors are useful for tight sensing locations. NOTE: These reflectors significantly decrease excess gain.		
Model	Description	
RAR-300SM	<ul style="list-style-type: none"> <li>Side mount reflector</li> <li>Profile dimension of 14 mm (0.56") in the direction of the scan</li> </ul>	
RAR-300FM	<ul style="list-style-type: none"> <li>Front mount reflector that attaches directly to the threaded barrel of most MINI-BEAMS</li> <li>Profile dimension of 34 mm (1.35") in the direction of the scan</li> </ul>	

Mounting Brackets			
Model	Description	Diagram	Image
SMB312S	Stainless steel 2-axis, side mounting bracket		
SMB312PD	Stainless steel 18 mm barrel-mounting bracket		
SMB312B	Stainless steel 2-axis, bottom mounting bracket		
SMB46L	<ul style="list-style-type: none"> <li>• "L" bracket</li> <li>• 14 ga 316 stainless steel</li> </ul>		

Mounting Brackets			
Model	Description	Dimensions	
SMB46S	<ul style="list-style-type: none"> <li>• "S" bracket</li> <li>• 14 ga 316 stainless steel</li> </ul>	<p>Technical drawing of the SMB46S "S" bracket. Dimensions include: 10 mm (0.4 in), 6 mm (0.2 in), 6 mm (0.2 in), 5 mm (0.2 in), 8 mm (0.3 in), 16 mm (0.6 in), 34 mm (1.3 in), 17 mm (0.7 in), 3.5 mm (0.14 in), 15 mm (0.6 in), <math>\phi 36</math> mm (1.4 in), <math>\phi 6.5</math> mm (0.26 in) (6x), 54 mm (2.1 in), 65 mm (2.6 in), 2 mm (.1 in), 27 mm (1.1 in), and 16 mm (0.6 in).</p>	
SMB46U	<ul style="list-style-type: none"> <li>• "U" bracket</li> <li>• 14 ga 316 stainless steel</li> </ul>	<p>Technical drawing of the SMB46U "U" bracket. Dimensions include: 17 mm (0.7 in), 13 mm (0.5 in), 6 mm (0.2 in), 6 mm (0.2 in), 5 mm (0.2 in), 8 mm (0.3 in), 16 mm (0.6 in), 34 mm (1.3 in), 17 mm (0.7 in), 3.5 mm (0.14 in), 15 mm (0.6 in), <math>\phi 36</math> mm (1.4 in), <math>\phi 6.5</math> mm (0.26 in) (6x), 54 mm (2.1 in), 65 mm (2.6 in), 2 mm (.1 in), 27 mm (1.1 in), 70 mm (2.8 in), and 16 mm (0.6 in).</p>	
SMB18C	<ul style="list-style-type: none"> <li>• 18 mm split clamp black PBT thermoplastic polyester bracket</li> <li>• Stainless steel mounting hardware included</li> </ul>	<p>Technical drawing of the SMB18C split clamp bracket. Dimensions include: 40.0 mm (1.60 in), 42.4 mm (1.67 in), 14.0 mm (0.55 in), 30.0 mm (1.18 in), 21.1 mm (0.83 in), 2.5 mm (0.10 in), 13 mm (0.5 in), and 10.6 mm (0.42 in). Hardware includes a Nut Plate and M5 x 0.8 x 60 mm Screw (2).</p>	
SMB18SF	<ul style="list-style-type: none"> <li>• 18 mm swivel bracket</li> <li>• Black thermoplastic polyester</li> <li>• Includes stainless steel swivel locking hardware</li> </ul>	<p>Technical drawing of the SMB18SF swivel bracket. Dimensions include: 36.0 mm (1.42 in), 42.0 mm (1.65 in), 50.8 mm (2.00 in), 10.6 mm (0.42 in), 22.9 mm (0.9 in), and 25.4 mm (1.00 in). Hardware includes an M18 x 1 internal thread.</p>	

# MINI-BEAM<sup>®</sup> Sensors SM312D

## Extension Cables (without connectors)

The following cables are available for extending the length of existing sensor cable. These are 30 m (100') lengths of MINI-BEAM cable. This cable may be spliced to existing cable. Connectors, if used, must be customer-supplied.

Model	Type	Used with:
EC312-100	4-conductor	All MINI-BEAM SM312 dc models

## Euro-Style Quick-Disconnect Cables

**Cable:** PVC jacket, polyurethane connector body, nickel-plated brass coupling nut  
**Conductors:** 22 or 20 AWG high-flex stranded, PVC insulation, gold-plated contacts  
**Temperature:** -40° to +90°C (-40° to +194°F)  
**Voltage Rating:** 250V ac/300V dc



Style	Model	Length	Dimensions:	Pin-out
4-Pin Straight	MQDC-406 MQDC-415 MQDC-430	2 m (6.5') 5 m (15') 9 m (30')		
4-Pin Right-angle	MQDC-406RA MQDC-415RA MQDC-430RA	2 m (6.5') 5 m (15') 9 m (30')		



### WARNING . . . Not To Be Used for Personnel Protection

Never use this product as a sensing device for personnel protection. Doing so could lead to serious injury or death.

This product does NOT include the self-checking redundant circuitry necessary to allow its use in personnel safety applications. A sensor failure or malfunction can cause either an energized or de-energized sensor output condition. Consult your current Banner Safety Products catalog for safety products which meet OSHA, ANSI and IEC standards for personnel protection.

**WARRANTY:** Banner Engineering Corp. warrants its products to be free from defects for one year. Banner Engineering Corp. will repair or replace, free of charge, any product of its manufacture found to be defective at the time it is returned to the factory during the warranty period. This warranty does not cover damage or liability for the improper application of Banner products. This warranty is in lieu of any other warranty either expressed or implied.