

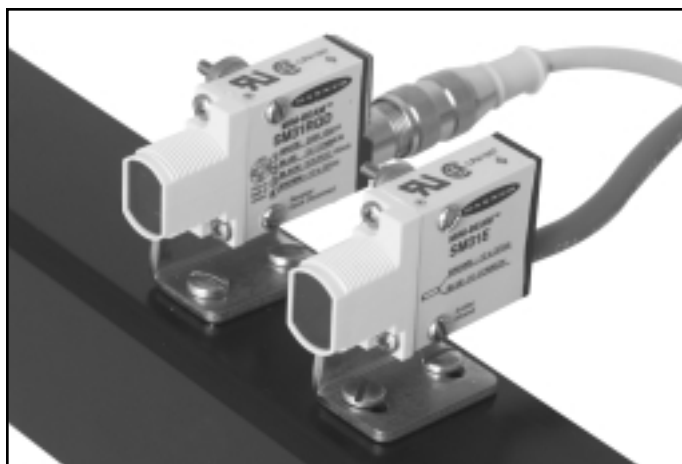

MINI-BEAM® SM31E/SM31R and SM31EL/SM31RL

Self-contained DC-operated Opposed Mode Sensors



- Compact, self-contained opposed mode modulated infrared sensor pairs for 10-30V dc operation
- Standard sensor pairs have 3 m (10 ft) range
- Long range sensor pairs have 30 m (100 ft) range
- Switch-selectable for light operate or dark operate; Highly repeatable, 1 millisecond response
- Both sourcing and sinking outputs (150 mA maximum ea.)
- Receivers include Banner's *exclusive* AID™ alignment system, US patent number 4356393
- Rugged, epoxy-encapsulated construction: meets NEMA standards 1, 2, 3, 3S, 4, 4X, 6, 12 and 13, IEC IP67
- Physically and electrically interchangeable with 18 mm barrel-type photoelectrics



Infrared, 880 nm

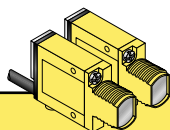

MINI-BEAM Opposed-Mode Emitter (E) and Receiver (R) Models

Models	Range	Cable*	Supply Voltage	Output Type	Excess Gain	Beam Pattern
SM31E SM31R SM31EQD SM31RQD	3 m (10')	2 m (6.5') 2 m (6.5') 4-Pin Euro QD 4-Pin Euro QD	10-30V dc	Bipolar NPN/PNP		
SM31EL SM31RL SM31ELQD SM31RLQD	30 m (100')	2 m (6.5') 2 m (6.5') 4-Pin Euro QD 4-Pin Euro QD	10-30V dc	Bipolar NPN/PNP		

***NOTES:**

- 9 m (30') cables are available by adding suffix "W/30" to the model number of any cabled sensor (e.g., SM31EL W/30).
- A 150 mm (6") long pigtail cable with attached QD connector is available by adding suffix "QDP" to the model number of any MINI-BEAM sensor (e.g., SM31ELQDP). See page 5 for more information.
- A model with a QD connector requires an accessory mating cable. See page 8 for more information.
- Emitters and receivers may be ordered with 0.3 millisecond on/off response by adding suffix "MHS" to the model numbers (e.g., SM31EMHS & SM31RMHS). This modification reduces sensing range (and excess gain).

MINI-BEAM Installation and Alignment

Proper operation of the sensors requires that they be mounted securely and aligned properly. Excessive movement or vibration can cause intermittent or false operation due to loss of alignment. For maximum mechanical stability, final-mount these sensors in 18-mm holes by their threaded barrels or use a mounting bracket (see page 6).

- 1) Begin with the emitter mounted securely in place. For small-parts counting applications, stretch a string between the emitter and receiver lenses to ensure that the sensing beam will pass through the center of the sensing location. For less critical applications, the receiver may be initially positioned by line-of-sight placement. Mount the receiver, leaving a means for movement.
- 2) Apply power to the emitter and receiver, and advance the receiver's 15-turn GAIN control to maximum (clockwise end of rotation). The GAIN control is clutched at both ends to avoid damage, and will "free-wheel" when either endpoint is reached.

If the receiver is "seeing" the emitter's light beam, the receiver alignment LED should be "on". Move the receiver up-down-right-left (include angular rotation) to obtain the fastest receiver LED pulse rate. If a pulse is not observable (too fast to count), reduce the GAIN control (counterclockwise rotation) to obtain a countable pulse rate of one to five beats per second. Note: to aid alignment at short ranges, it may help to further reduce the strength of the light signal by temporarily masking the emitter and/or receiver lens with tape or a sheet of paper.

- 3) Repeat the alignment motions after each GAIN reduction. When you have found the receiver orientation that produces the fastest pulse rate, mount the receiver solidly in that position. Remove any masking material, and increase the receiver GAIN to maximum. Test the system by placing the object to be detected into the sensing position. The receiver LED indicator should go "off". If it does not go "off", the cause is probably either "flooding" or "burn-through".

Flooding occurs when a portion of the effective beam passes *around* the object to be sensed and activates the receiver. Check that the object completely breaks the beam, and that the beam is centered on the object. Add apertures, if necessary, to tailor the effective beam to the size or profile of the object being sensed. *Burn-through* refers to a portion of the emitter's light energy passing *through* a thin or translucent object and activating the receiver. Try sensing at a reduced GAIN setting or consider an alternative sensing scheme.

Opposed Mode Alignment

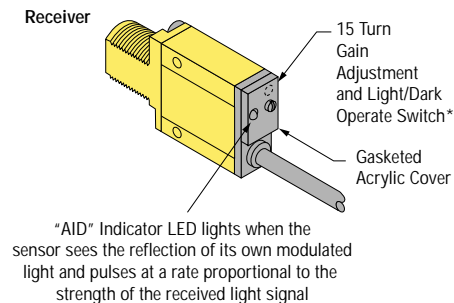
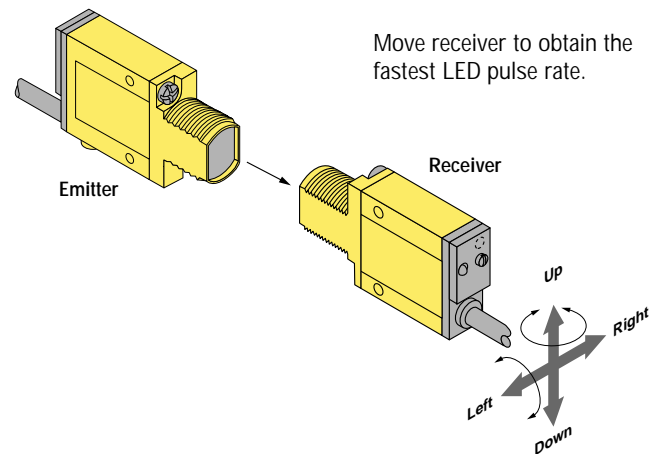

* Note regarding Light/Dark operate switch:

- Turn switch *fully* clockwise for light operate (sensor outputs conduct when sensing light is received)
- Turn switch *fully* counterclockwise for dark operate (sensor outputs conduct when sensing light is not received)

MINI-BEAM[®] Sensors SM31E/SM31R and SM31EL/SM31RL

MINI-BEAM DC Sensor Specifications	
Supply Voltage and Current	10 to 30V dc (10% maximum ripple) at less than 25 mA (exclusive of load)
Supply Protection Circuitry	Protected against reverse polarity and transient voltages
Output Configuration	Bipolar: One current sourcing (PNP) and one current sinking (NPN) open-collector transistor
Output Rating	150mA maximum each output at 25°C, derated to 100 mA at 70°C (derate ≈1 mA per °C) Off-state leakage current less than 1 microamp Output saturation voltage (PNP output) less than 1 volt at 10 mA and less than 2 volts at 150 mA Output saturation voltage (NPN output) less than 200 millivolts at 10 mA and less than 1 volt at 150 mA
Output Protection Circuitry	Protected against false pulse on power-up and continuous overload or short-circuit of outputs
Output Response Time	Sensors will respond to either a "light" or a "dark" signal of 1 millisecond or longer duration, 500 Hz max. 0.3 millisecond response modification is available. See note below. (100 millisecond delay on power-up; outputs do not conduct during this time.) NOTE: DC MINI-BEAMS may be ordered with 0.3 millisecond on/off response by adding suffix "MHS" to the model numbers (e.g. SM31EMHS & SM31RMHS). This modification reduces sensing range (and excess gain).
Adjustments	LIGHT/DARK OPERATE select switch, and 15-turn slotted brass screw GAIN (sensitivity) adjustment potentiometer (clutched at both ends of travel). Both controls are located on rear panel of sensor and protected by a gasketed, clear acrylic cover.
Indicators	Exclusive, patented Alignment Indicating Device system (AID [™] , US patent #4356393) lights a rear-panel mounted red LED indicator whenever the sensor sees a "light" condition, with a superimposed pulse rate proportional to the light signal strength (the stronger the signal, the faster the pulse rate).
Construction	Reinforced thermoplastic polyester housing, totally encapsulated, o-ring sealing, acrylic lenses, and stainless steel screws.
Environmental Rating	Meets NEMA standards 1, 2, 3, 3S, 4, 4X, 6, 12, and 13; IEC IP67
Connections	PVC-jacketed 4-conductor 2 m (6.5') or 9 m (30') cables, or 4-pin Euro-style quick disconnect (QD) fitting are available. QD cables are ordered separately. See page 8.
Operating Temperature	Temperature: -20° to +70°C (-4° to +158°F) Maximum relative humidity: 90% at 50°C (non-condensing)
Application Notes	The NPN (current sinking) output of dc MINI-BEAM sensors is directly compatible as an input to Banner logic modules, including all non-amplified MAXI-AMP and MICRO-AMP modules. MINI-BEAMS are TTL compatible.
Certifications	

NOTE: DC MINI-BEAMS may be ordered with 0.3 millisecond on/off response by adding suffix "MHS" to the model numbers (e.g. - SM31EMHS & SM31RMHS). This modification reduces sensing range (and excess gain).

MINI-BEAM DC Hookup Diagrams

Receivers with Attached Cable

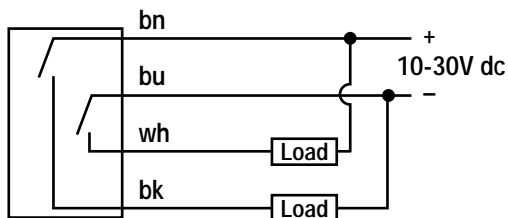

Receivers with Quick Disconnect (4-Pin Euro-Style)

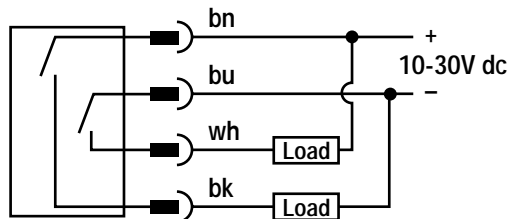

Emitters with Attached Cable

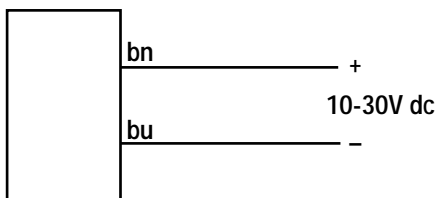

Emitter with Quick Disconnect (4-Pin Euro-Style)

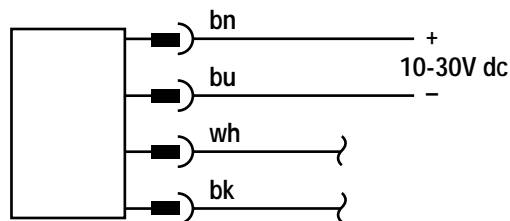

4-Pin Euro-Style Pin-out (Cable Connector Shown)

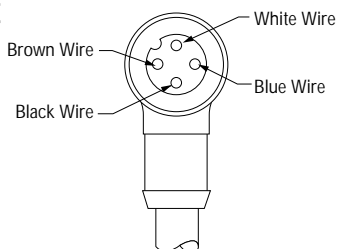

Quick Disconnect (QD) Option

DC MINI-BEAM sensors are sold with either a 2 m (6.5') or a 9 m (30') attached PVC-covered cable, or with a 4-pin Euro-style QD cable fitting.

DC QD sensors are identified by the letters "QD" in their model number suffix. For more information on mating QD cables, see page 8.

MINI-BEAM Dimensions

MINI-BEAM DC Sensor with Integral Cable

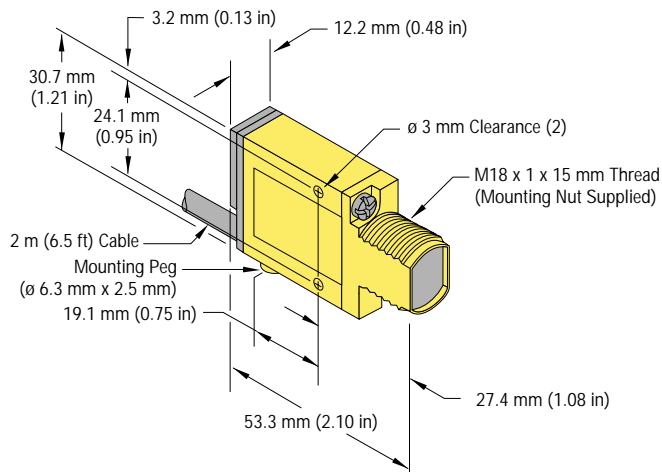

MINI-BEAM DC Sensor with Quick-Disconnect

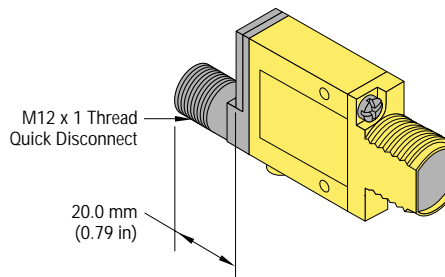

MINI-BEAM® Sensors SM31E/SM31R and SM31EL/SM31RL

MINI-BEAM Modifications			
Model Suffix	Modification	Description	Example of Model Number
W/30	9 meter (30') cable	All MINI-BEAM sensors may be ordered with an integral 9 m (30') cable in place of the standard 2 m (6.5') cable	SM31E W/30
MHS	Modified for High Speed	Standard dc MINI-BEAM sensors with 1 millisecond output response may be modified for 0.3 millisecond (300 μs) response. NOTE: Faster response comes at the expense of lower excess gain. Also, operating temperature range becomes -20° to +50°C (-4° to +122°F)	SM31EMHS NOTE: Emitter and receiver must both have MHS modification
QDP	Pigtail Quick Disconnect	All MINI-BEAMS may be built with a 150 mm (6") long integral cable which is terminated with the appropriate QD connector.	SM31EQDP



Apertures

Opposed mode MINI-BEAM sensors may be fitted with apertures which narrow or shape the effective beam of the sensor to more closely match the size or profile of the object to be sensed. A common example is the use of "line" or "slit" type aperture when wire or thread is sensed. Each model contains 20 apertures.

Model	Description	
AP31-020 AP31-040 AP31-100	0.5 mm (0.02") diameter, circular 1.0 mm (0.04") diameter, circular 2.5 mm (0.10") diameter, circular	
AP31-020H AP31-040H AP31-100H AP31-200H	0.5 x 6.4 mm (0.02" x 0.25"), horizontal slotted 1.0 x 6.4 mm (0.04" x 0.25"), horizontal slotted 2.5 x 6.4 mm (0.10" x 0.25"), horizontal slotted 5.1 x 6.4 mm (0.20" x 0.25"), horizontal slotted	
AP31-020V AP31-040V AP31-100V AP31-200V	0.5 x 12.7 mm (0.02" x 0.50"), vertical slotted 1.0 x 12.7 mm (0.04" x 0.50"), vertical slotted 2.5 x 12.7 mm (0.10" x 0.50"), vertical slotted 5.1 x 12.7 mm (0.20" x 0.50"), vertical slotted	
AP31-DVHX2	Kit containing two of each aperture	

Replacement Lens Assemblies

MINI-BEAM lens assemblies are field-replaceable.



Model	Description	
UC-300E	Replacement lens for E/R	
UC-300EL	Replacement lens for EL/RL or use for extending range of E/R	

Right-Angle Reflectors





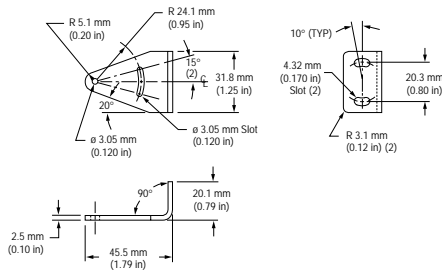

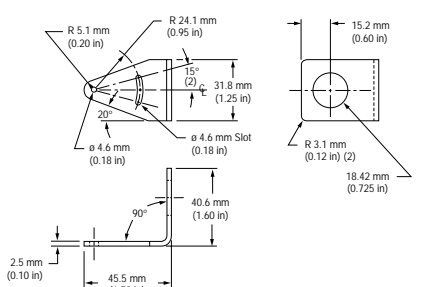
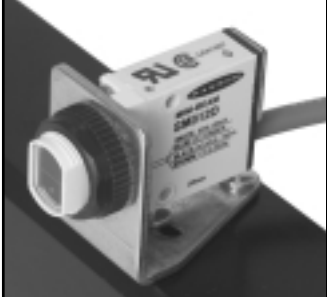
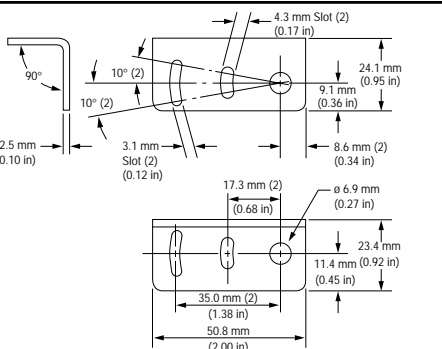
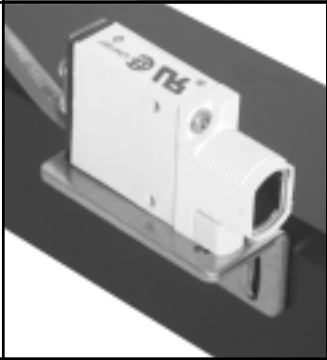
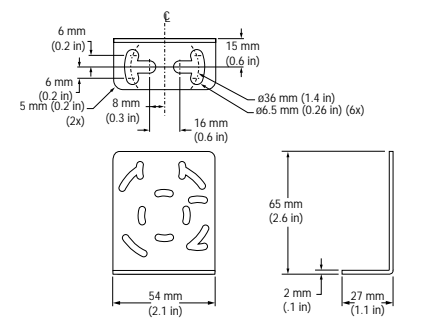
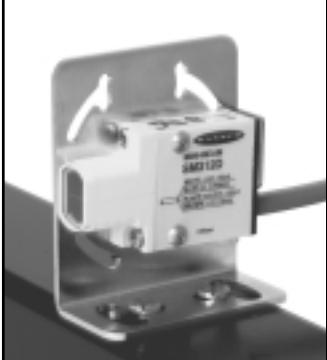

MINI-BEAM right-angle reflectors are useful for tight sensing locations. NOTE: These reflectors significantly decrease excess gain.

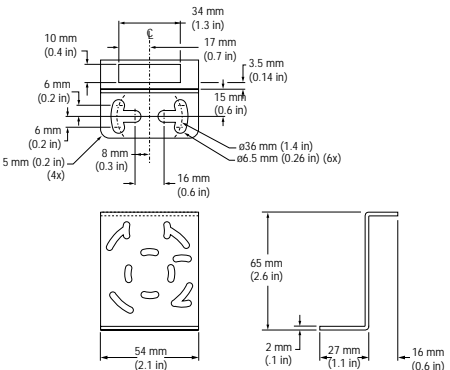
Model	Description	
RAR-300SM	<ul style="list-style-type: none"> Side mount reflector Profile dimension of 14 mm (0.56") in the direction of the scan 	
RAR-300FM	<ul style="list-style-type: none"> Front mount reflector that attaches directly to the threaded barrel of most MINI-BEAMS Profile dimension of 34 mm (1.35") in the direction of the scan 	

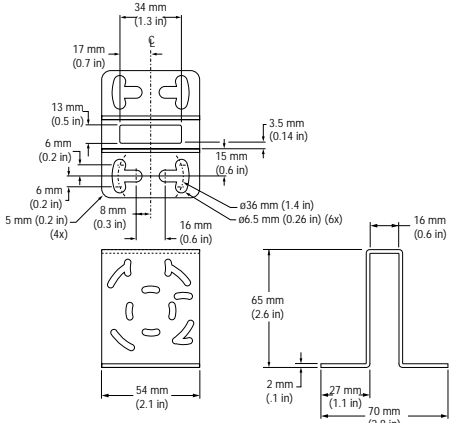
MINI-BEAM® Sensors SM31E/SM31R and SM31EL/SM31RL

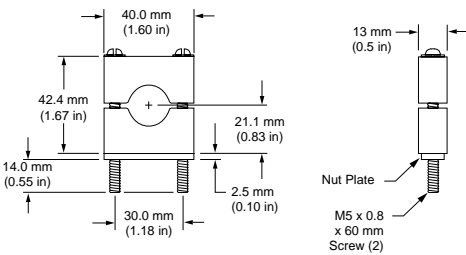
Mounting Brackets			
Model	Description	Description	
SMB312S	Stainless steel 2-axis, side mounting bracket		
SMB312PD	Stainless steel 18 mm barrel-mounting bracket		
SMB312B	Stainless steel 2-axis, bottom mounting bracket		
SMB46L	<ul style="list-style-type: none"> • "L" bracket • 14 ga 316 stainless steel 		

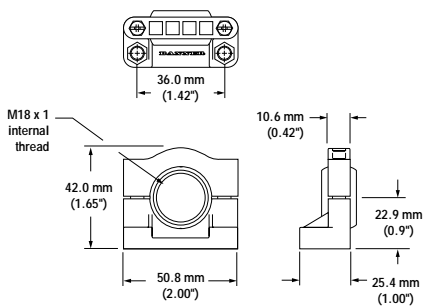
MINI-BEAM® Sensors SM31E/SM31R and SM31EL/SM31RL

Mounting Brackets		
Model	Description	Dimensions
SMB46S	<ul style="list-style-type: none"> • "S" bracket • 14 ga 316 stainless steel 	 
SMB46U	<ul style="list-style-type: none"> • "U" bracket • 14 ga 316 stainless steel 	 
SMB18C	<ul style="list-style-type: none"> • 18 mm split clamp black thermoplastic polyester bracket • Stainless steel mounting hardware included 	 
SMB18SF	<ul style="list-style-type: none"> • 18 mm swivel bracket • Black thermoplastic polyester • Includes stainless steel swivel locking hardware 	 

MINI-BEAM[®] Sensors SM31E/SM31R and SM31EL/SM31RL

Extension Cables (without connectors)

The following cables are available for extending the length of existing sensor cable. These are 30 m (100') lengths of MINI-BEAM cable. This cable may be spliced to existing cable. Connectors, if used, must be customer-supplied.

Model	Type	Used with:
EC312-100	4-conductor	MINI-BEAM dc receivers
EC312A-100	2-conductor	MINI-BEAM emitters

Euro-Style Quick-Disconnect Cables

Cable: PVC jacket, polyurethane connector body, nickel-plated brass coupling nut
Conductors: 22 or 20 AWG high-flex stranded, PVC insulation, gold-plated contacts
Temperature: -40° to +90°C (-40° to +194°F)
Voltage Rating: 250V ac/300V dc



Style	Model	Length	Dimensions:	Pin-out
4-Pin Straight	MQDC-406 MQDC-415 MQDC-430	2 m (6.5') 5 m (15') 9 m (30')		
4-Pin Right-angle	MQDC-406RA MQDC-415RA MQDC-430RA	2 m (6.5') 5 m (15') 9 m (30')		



WARNING . . . Not To Be Used for Personnel Protection

Never use this product as a sensing device for personnel protection. Doing so could lead to serious injury or death.

This product does NOT include the self-checking redundant circuitry necessary to allow its use in personnel safety applications. A sensor failure or malfunction can cause either an energized or de-energized sensor output condition. Consult your current Banner Safety Products catalog for safety products which meet OSHA, ANSI and IEC standards for personnel protection.

WARRANTY: Banner Engineering Corp. warrants its products to be free from defects for one year. Banner Engineering Corp. will repair or replace, free of charge, any product of its manufacture found to be defective at the time it is returned to the factory during the warranty period. This warranty does not cover damage or liability for the improper application of Banner products. This warranty is in lieu of any other warranty either expressed or implied.



MINI-BEAM® SM31E/SM31R and SM31EL/SM31RL

Self-contained DC-operated Opposed Mode Sensors

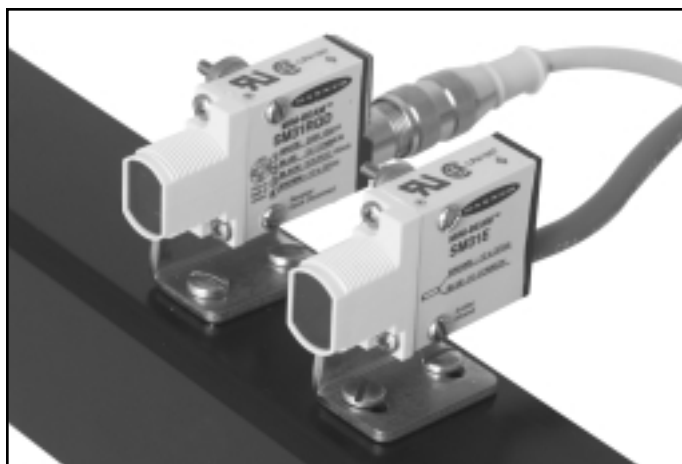

- Compact, self-contained opposed mode modulated infrared sensor pairs for 10-30V dc operation
- Standard sensor pairs have 3 m (10 ft) range
- Long range sensor pairs have 30 m (100 ft) range
- Switch-selectable for light operate or dark operate; Highly repeatable, 1 millisecond response
- Both sourcing and sinking outputs (150 mA maximum ea.)
- Receivers include Banner's *exclusive* AID™ alignment system, US patent number 4356393
- Rugged, epoxy-encapsulated construction: meets NEMA standards 1, 2, 3, 3S, 4, 4X, 6, 12 and 13, IEC IP67
- Physically and electrically interchangeable with 18 mm barrel-type photoelectrics



Infrared, 880 nm

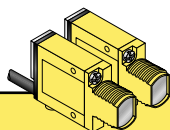

MINI-BEAM Opposed-Mode Emitter (E) and Receiver (R) Models

Models	Range	Cable*	Supply Voltage	Output Type	Excess Gain	Beam Pattern
SM31E SM31R SM31EQD SM31RQD	3 m (10')	2 m (6.5') 2 m (6.5') 4-Pin Euro QD 4-Pin Euro QD	10-30V dc	Bipolar NPN/PNP		
SM31EL SM31RL SM31ELQD SM31RLQD	30 m (100')	2 m (6.5') 2 m (6.5') 4-Pin Euro QD 4-Pin Euro QD	10-30V dc	Bipolar NPN/PNP		

***NOTES:**

- 9 m (30') cables are available by adding suffix "W/30" to the model number of any cabled sensor (e.g., SM31EL W/30).
- A 150 mm (6") long pigtail cable with attached QD connector is available by adding suffix "QDP" to the model number of any MINI-BEAM sensor (e.g., SM31ELQDP). See page 5 for more information.
- A model with a QD connector requires an accessory mating cable. See page 8 for more information.
- Emitters and receivers may be ordered with 0.3 millisecond on/off response by adding suffix "MHS" to the model numbers (e.g., SM31EMHS & SM31RMHS). This modification reduces sensing range (and excess gain).

MINI-BEAM Installation and Alignment

Proper operation of the sensors requires that they be mounted securely and aligned properly. Excessive movement or vibration can cause intermittent or false operation due to loss of alignment. For maximum mechanical stability, final-mount these sensors in 18-mm holes by their threaded barrels or use a mounting bracket (see page 6).

- 1) Begin with the emitter mounted securely in place. For small-parts counting applications, stretch a string between the emitter and receiver lenses to ensure that the sensing beam will pass through the center of the sensing location. For less critical applications, the receiver may be initially positioned by line-of-sight placement. Mount the receiver, leaving a means for movement.
- 2) Apply power to the emitter and receiver, and advance the receiver's 15-turn GAIN control to maximum (clockwise end of rotation). The GAIN control is clutched at both ends to avoid damage, and will "free-wheel" when either endpoint is reached.

If the receiver is "seeing" the emitter's light beam, the receiver alignment LED should be "on". Move the receiver up-down-right-left (include angular rotation) to obtain the fastest receiver LED pulse rate. If a pulse is not observable (too fast to count), reduce the GAIN control (counterclockwise rotation) to obtain a countable pulse rate of one to five beats per second. Note: to aid alignment at short ranges, it may help to further reduce the strength of the light signal by temporarily masking the emitter and/or receiver lens with tape or a sheet of paper.

- 3) Repeat the alignment motions after each GAIN reduction. When you have found the receiver orientation that produces the fastest pulse rate, mount the receiver solidly in that position. Remove any masking material, and increase the receiver GAIN to maximum. Test the system by placing the object to be detected into the sensing position. The receiver LED indicator should go "off". If it does not go "off", the cause is probably either "flooding" or "burn-through".

Flooding occurs when a portion of the effective beam passes *around* the object to be sensed and activates the receiver. Check that the object completely breaks the beam, and that the beam is centered on the object. Add apertures, if necessary, to tailor the effective beam to the size or profile of the object being sensed. *Burn-through* refers to a portion of the emitter's light energy passing *through* a thin or translucent object and activating the receiver. Try sensing at a reduced GAIN setting or consider an alternative sensing scheme.

Opposed Mode Alignment

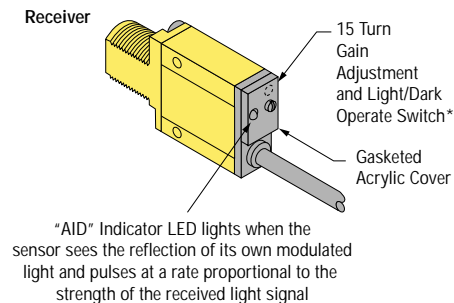
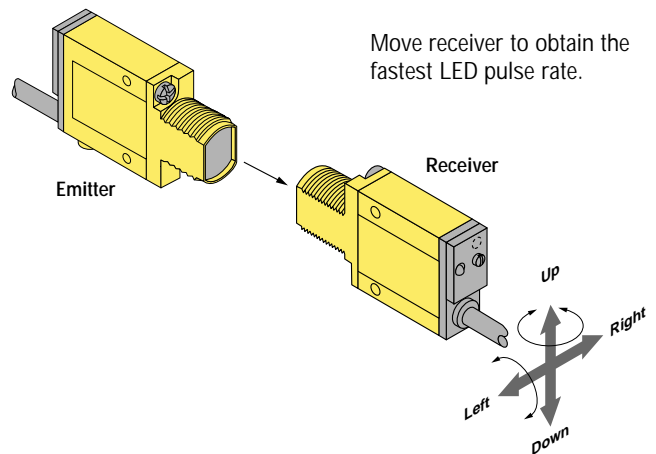

* Note regarding Light/Dark operate switch:

- Turn switch *fully* clockwise for light operate (sensor outputs conduct when sensing light is received)
- Turn switch *fully* counterclockwise for dark operate (sensor outputs conduct when sensing light is not received)

MINI-BEAM[®] Sensors SM31E/SM31R and SM31EL/SM31RL

MINI-BEAM DC Sensor Specifications	
Supply Voltage and Current	10 to 30V dc (10% maximum ripple) at less than 25 mA (exclusive of load)
Supply Protection Circuitry	Protected against reverse polarity and transient voltages
Output Configuration	Bipolar: One current sourcing (PNP) and one current sinking (NPN) open-collector transistor
Output Rating	150mA maximum each output at 25°C, derated to 100 mA at 70°C (derate ≈1 mA per °C) Off-state leakage current less than 1 microamp Output saturation voltage (PNP output) less than 1 volt at 10 mA and less than 2 volts at 150 mA Output saturation voltage (NPN output) less than 200 millivolts at 10 mA and less than 1 volt at 150 mA
Output Protection Circuitry	Protected against false pulse on power-up and continuous overload or short-circuit of outputs
Output Response Time	Sensors will respond to either a "light" or a "dark" signal of 1 millisecond or longer duration, 500 Hz max. 0.3 millisecond response modification is available. See note below. (100 millisecond delay on power-up; outputs do not conduct during this time.) NOTE: DC MINI-BEAMS may be ordered with 0.3 millisecond on/off response by adding suffix "MHS" to the model numbers (e.g. SM31EMHS & SM31RMHS). This modification reduces sensing range (and excess gain).
Adjustments	LIGHT/DARK OPERATE select switch, and 15-turn slotted brass screw GAIN (sensitivity) adjustment potentiometer (clutched at both ends of travel). Both controls are located on rear panel of sensor and protected by a gasketed, clear acrylic cover.
Indicators	Exclusive, patented Alignment Indicating Device system (AID [™] , US patent #4356393) lights a rear-panel mounted red LED indicator whenever the sensor sees a "light" condition, with a superimposed pulse rate proportional to the light signal strength (the stronger the signal, the faster the pulse rate).
Construction	Reinforced thermoplastic polyester housing, totally encapsulated, o-ring sealing, acrylic lenses, and stainless steel screws.
Environmental Rating	Meets NEMA standards 1, 2, 3, 3S, 4, 4X, 6, 12, and 13; IEC IP67
Connections	PVC-jacketed 4-conductor 2 m (6.5') or 9 m (30') cables, or 4-pin Euro-style quick disconnect (QD) fitting are available. QD cables are ordered separately. See page 8.
Operating Temperature	Temperature: -20° to +70°C (-4° to +158°F) Maximum relative humidity: 90% at 50°C (non-condensing)
Application Notes	The NPN (current sinking) output of dc MINI-BEAM sensors is directly compatible as an input to Banner logic modules, including all non-amplified MAXI-AMP and MICRO-AMP modules. MINI-BEAMS are TTL compatible.
Certifications	

NOTE: DC MINI-BEAMS may be ordered with 0.3 millisecond on/off response by adding suffix "MHS" to the model numbers (e.g. - SM31EMHS & SM31RMHS). This modification reduces sensing range (and excess gain).

MINI-BEAM DC Hookup Diagrams

Receivers with Attached Cable

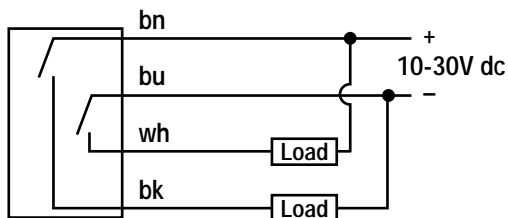

Receivers with Quick Disconnect (4-Pin Euro-Style)

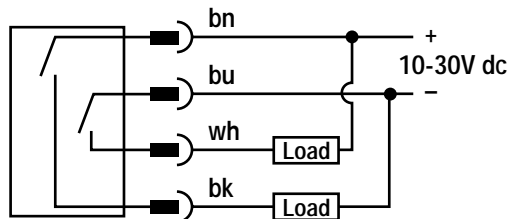

Emitters with Attached Cable

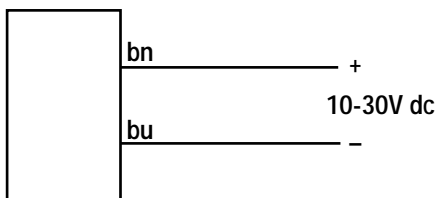

Emitter with Quick Disconnect (4-Pin Euro-Style)

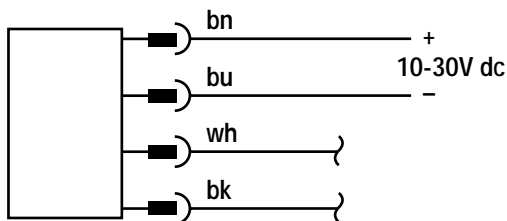

4-Pin Euro-Style Pin-out (Cable Connector Shown)

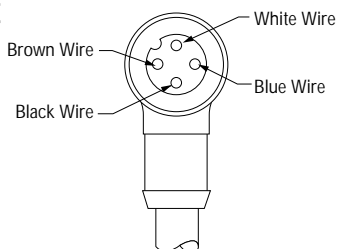

Quick Disconnect (QD) Option

DC MINI-BEAM sensors are sold with either a 2 m (6.5') or a 9 m (30') attached PVC-covered cable, or with a 4-pin Euro-style QD cable fitting.

DC QD sensors are identified by the letters "QD" in their model number suffix. For more information on mating QD cables, see page 8.

MINI-BEAM Dimensions

MINI-BEAM DC Sensor with Integral Cable

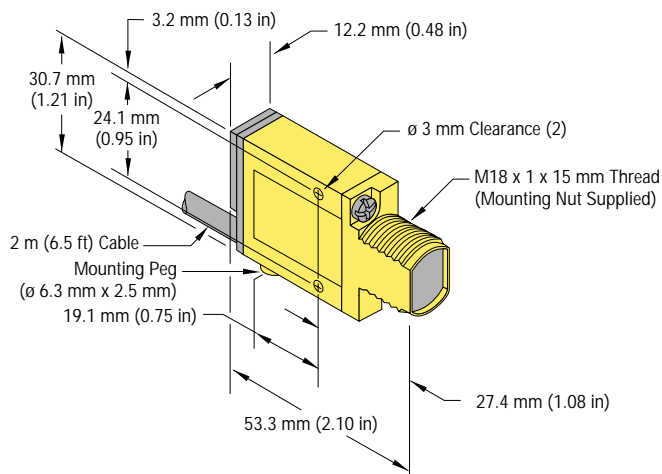

MINI-BEAM DC Sensor with Quick-Disconnect

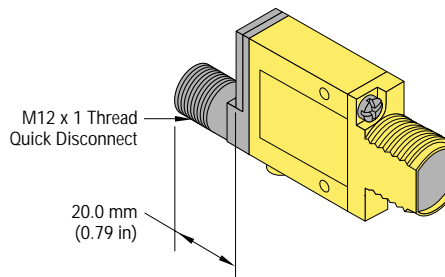

MINI-BEAM® Sensors SM31E/SM31R and SM31EL/SM31RL

MINI-BEAM Modifications			
Model Suffix	Modification	Description	Example of Model Number
W/30	9 meter (30') cable	All MINI-BEAM sensors may be ordered with an integral 9 m (30') cable in place of the standard 2 m (6.5') cable	SM31E W/30
MHS	Modified for High Speed	Standard dc MINI-BEAM sensors with 1 millisecond output response may be modified for 0.3 millisecond (300 μs) response. NOTE: Faster response comes at the expense of lower excess gain. Also, operating temperature range becomes -20° to +50°C (-4° to +122°F)	SM31EMHS NOTE: Emitter and receiver must both have MHS modification
QDP	Pigtail Quick Disconnect	All MINI-BEAMS may be built with a 150 mm (6") long integral cable which is terminated with the appropriate QD connector.	SM31EQDP



Apertures

Opposed mode MINI-BEAM sensors may be fitted with apertures which narrow or shape the effective beam of the sensor to more closely match the size or profile of the object to be sensed. A common example is the use of "line" or "slit" type aperture when wire or thread is to be sensed. Each model contains 20 apertures.

Model	Description	
AP31-020 AP31-040 AP31-100	0.5 mm (0.02") diameter, circular 1.0 mm (0.04") diameter, circular 2.5 mm (0.10") diameter, circular	
AP31-020H AP31-040H AP31-100H AP31-200H	0.5 x 6.4 mm (0.02" x 0.25"), horizontal slotted 1.0 x 6.4 mm (0.04" x 0.25"), horizontal slotted 2.5 x 6.4 mm (0.10" x 0.25"), horizontal slotted 5.1 x 6.4 mm (0.20" x 0.25"), horizontal slotted	
AP31-020V AP31-040V AP31-100V AP31-200V	0.5 x 12.7 mm (0.02" x 0.50"), vertical slotted 1.0 x 12.7 mm (0.04" x 0.50"), vertical slotted 2.5 x 12.7 mm (0.10" x 0.50"), vertical slotted 5.1 x 12.7 mm (0.20" x 0.50"), vertical slotted	
AP31-DVHX2	Kit containing two of each aperture	

Replacement Lens Assemblies

MINI-BEAM lens assemblies are field-replaceable.





Model	Description	
UC-300E	Replacement lens for E/R	
UC-300EL	Replacement lens for EL/RL or use for extending range of E/R	

Right-Angle Reflectors

MINI-BEAM right-angle reflectors are useful for tight sensing locations. NOTE: These reflectors significantly decrease excess gain.

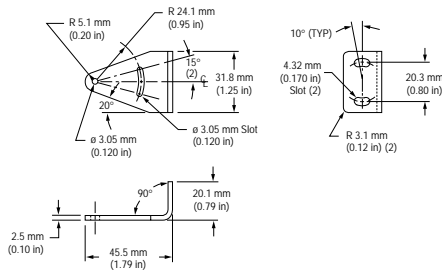
Model	Description	
RAR-300SM	<ul style="list-style-type: none"> Side mount reflector Profile dimension of 14 mm (0.56") in the direction of the scan 	
RAR-300FM	<ul style="list-style-type: none"> Front mount reflector that attaches directly to the threaded barrel of most MINI-BEAMS Profile dimension of 34 mm (1.35") in the direction of the scan 	

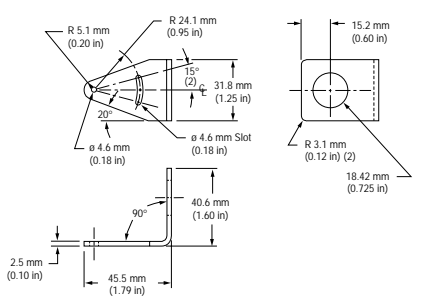
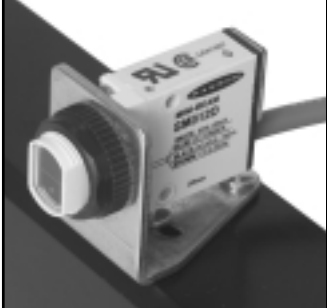
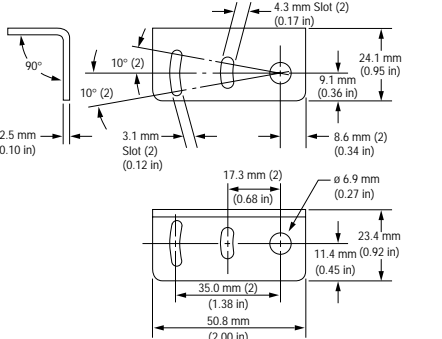
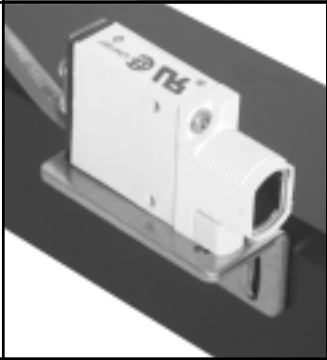
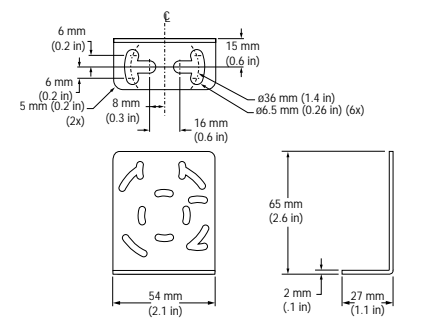
MINI-BEAM® Sensors SM31E/SM31R and SM31EL/SM31RL

Mounting Brackets			
Model	Description	Description	
SMB312S	Stainless steel 2-axis, side mounting bracket		
SMB312PD	Stainless steel 18 mm barrel-mounting bracket		
SMB312B	Stainless steel 2-axis, bottom mounting bracket		
SMB46L	<ul style="list-style-type: none"> • "L" bracket • 14 ga 316 stainless steel 		

MINI-BEAM[®] Sensors SM31E/SM31R and SM31EL/SM31RL

Mounting Brackets			
Model	Description	Dimensions	
SMB46S	<ul style="list-style-type: none"> • "S" bracket • 14 ga 316 stainless steel 		
SMB46U	<ul style="list-style-type: none"> • "U" bracket • 14 ga 316 stainless steel 		
SMB18C	<ul style="list-style-type: none"> • 18 mm split clamp black thermoplastic polyester bracket • Stainless steel mounting hardware included 		
SMB18SF	<ul style="list-style-type: none"> • 18 mm swivel bracket • Black thermoplastic polyester • Includes stainless steel swivel locking hardware 		

MINI-BEAM[®] Sensors SM31E/SM31R and SM31EL/SM31RL

Extension Cables (without connectors)

The following cables are available for extending the length of existing sensor cable. These are 30 m (100') lengths of MINI-BEAM cable. This cable may be spliced to existing cable. Connectors, if used, must be customer-supplied.

Model	Type	Used with:
EC312-100	4-conductor	MINI-BEAM dc receivers
EC312A-100	2-conductor	MINI-BEAM emitters

Euro-Style Quick-Disconnect Cables

Cable: PVC jacket, polyurethane connector body, nickel-plated brass coupling nut
Conductors: 22 or 20 AWG high-flex stranded, PVC insulation, gold-plated contacts
Temperature: -40° to +90°C (-40° to +194°F)
Voltage Rating: 250V ac/300V dc



Style	Model	Length	Dimensions:	Pin-out
4-Pin Straight	MQDC-406 MQDC-415 MQDC-430	2 m (6.5') 5 m (15') 9 m (30')		
4-Pin Right-angle	MQDC-406RA MQDC-415RA MQDC-430RA	2 m (6.5') 5 m (15') 9 m (30')		



WARNING . . . Not To Be Used for Personnel Protection

Never use this product as a sensing device for personnel protection. Doing so could lead to serious injury or death.

This product does NOT include the self-checking redundant circuitry necessary to allow its use in personnel safety applications. A sensor failure or malfunction can cause either an energized or de-energized sensor output condition. Consult your current Banner Safety Products catalog for safety products which meet OSHA, ANSI and IEC standards for personnel protection.

WARRANTY: Banner Engineering Corp. warrants its products to be free from defects for one year. Banner Engineering Corp. will repair or replace, free of charge, any product of its manufacture found to be defective at the time it is returned to the factory during the warranty period. This warranty does not cover damage or liability for the improper application of Banner products. This warranty is in lieu of any other warranty either expressed or implied.