

## DESCRIPTION

The Halo Surface Mount LED Downlight (SMD) is an low profile surface mounting luminaire with a modern look and high performance. SMD4 (4") is designed for installation in many 3-1/2" and 4" square, octagon, or round junction boxes. Supply wire adapter with LED quick wiring connector included. The SMD4 may also retrofit in 4" aperture IC and Non-IC recessed housings.

Catalog #		Type
Project		
Comments		Date
Prepared by		

## SPECIFICATION FEATURES

### HOUSING

- Non-electrically conductive polycarbonate frame.
- High impact diffuse polystyrene lens provides shielding to the light guide with no pixilation
- Stamped aluminum housing provides thermal cooling achieving L70 at 50,000 hours in IC and non-IC applications

### GASKETS

- Closed cell gasket achieves restrictive airflow and wet location requirements without additional caulking

### OPTICS

- Precision acrylic light guide organizes source flux into wide distribution with 1.2 – 1.4 spacing criteria useful for general area illumination

### LED

- Mid power led array provide a uniform source with high efficiency and long life.
- Available in 90 CRI minimum, R9 greater than 50 and color accuracy within 3 SDCM provide color accuracy and uniformity

### DRIVER

- Integral 120V 50/60Hz constant current driver provides noise free operation.
- Continuous, flicker-free dimming from 100% to 5% with select leading or trailing edge 120V phase cut dimmers.
- Dimming to 5% is best assured using dimmers with low end trim adjustment. Consult dimmer manufacturer for compatibility and conditions of use. (Note some dimmers require a neutral in the wallbox.)
- Inline electrical quick connect and E26 adapter (provided) provides mains connections.

### MOUNTING/RETENTION

- Adjustable spider plate allows for quick installation into both junction boxes and recessed housings.
- Torsion springs or friction blades included

### ELECTRICAL JUNCTION BOX MOUNTING

- The SMD may be used in compatible electrical junction boxes in direct contact with insulation including spray foam insulation.
- Suitable for installation in many 3-1/2" and 4" square, octagon, and round electrical junction boxes.
- Surface mounting in a fire-rated ceiling using an appropriate fire rated electrical box .  
Note: Fire-rating is per the rating of the ceiling and applicable junction box, not the SMD.
- Installer must ensure compatibility of fit, wiring and proper mounting in the electrical junction box. This includes all applicable national and local electrical and building coded

### RECESSED HOUSING MOUNTING

- May be installed in IC recessed housings in direct contact with insulation  
**Note:** Not for use in recessed housing in direct contact with spray foam insulation. Refer to NEMA LSD 57-2013.

### Friction Blade 4"

- Precision formed friction blades included
- For retrofit in 4" nominal housings
- Friction blade design allows the SMD to be installed in any position within the housing aperture (360 degrees)

### DESIGNER SKINS (SOLD SEPARATELY)

- SMD skins are accessory rings in both round and square. These skins attach to the SMD for a permanent finish. Refer to the SMD accessories specification sheet for details.
- Matte White (Paintable)
- Satin Nickel
- Tuscan Bronze

### WARRANTY

- Five year limited warranty, consult website for details.  
[www.eaton.com/lighting/legal](http://www.eaton.com/lighting/legal)

### COMPLIANCE

- cULus listed / certified for use with Halo housings, classified for use with other's housings, see instruction sheet for conditions of acceptability.
- Wet and Damp Location listed, airtight per ASTM-E283
- Suitable for use in clothes closets when installed in accordance with the NEC 410.16 spacing requirements.
- EMI/RFI emissions per FCC 47CFR Part 15B
- Contains no mercury or lead and RoHS compliant.
- Photometric testing in accordance with IES LM-79-08
- Lumen maintenance projections in accordance with IES LM-80-08 and TM-21-11.
- Can be used for State of California Title 24 high efficacy luminaire compliance, reference the California Energy Commission Title 20 Appliance Efficiency Database for current listings.
- Can be used for International Energy Conservation Coe (IECC) and Washington State Energy Code high efficiency luminaire compliance

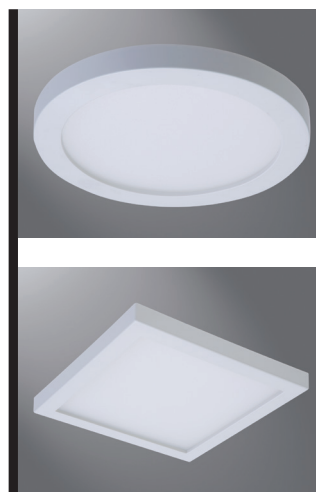

## SMD4 Series

4 inch Round and Square

**SMD4R  
SMD4S**

## 4" Surface Mount Downlight

**Suitable for ceiling or wall electrical junction boxes**

**Suitable for 4" recessed housing retrofit**

## ENERGY DATA

	Round	Square
Lumens (5000K models)	786	810
Input Power	9.7 W	10 W
Input Current	0.0811 A	0.0829 A
Efficiency	81 lm/W	81 lm/W
THD	13.3	13.2
Input Voltage	120V	
Frequency	50/60 Hz	
CRI	90 CRI	
Power Factor	0.99	
T Ambient	-30 - +40°C	
Sound Rating	Class A	



Refer to ENERGY STAR® Qualified Products List.  
Can be used to comply with California Title 24 High Efficacy requirements.  
Certified to California Appliance Efficiency Database under JA8.

## DIMENSIONS

SMD4RXXWH



SMD4SXXWH



## ORDERING INFORMATION

**SAMPLE NUMBER:** SMD4R6930WH=4" Round Surface Mount Downlight, 90CRI, 3000K

**Junction Box Installation:** Order junction box separately, as supplied by others, to complete installation.

**Recessed Installation:** Order Halo recessed housing separately to complete installation.

Models	Lumens	CRI / CCT	Finish	Accessories
<b>SMD4R</b> = 4" Round Surface Mount Downlight, 120V <b>SMD4S</b> = 4" Square Surface Mount Downlight, 120V	<b>6</b> =600 lumen series	<b>927</b> =90CRI, 2700K <b>930</b> =90CRI, 3000K <b>935</b> =90CRI, 3500K <b>940</b> =90CRI, 4000K <b>950</b> =90CRI, 5000K	<b>WH</b> =Mate White	<u>Designer Trims</u> <b>SMD4RTRMSN</b> =4" Round SMD Satin Nickel <b>SMD4RTRMTBZ</b> =4" Round SMD Tuscan Bronze <b>SMD4RTRMWH</b> =4" Round SMD White (paintable)  <b>SMD4STRMSN</b> =4" Square SMD Satin Nickel <b>SMD4STRMTBZ</b> =4" Square SMD Tuscan Bronze <b>SMD4STRMWH</b> =4" Square SMD White (paintable)

## ACCESSORIES

### Designer Trims



**SMD4STRMWH**  
square, white (paintable)



**SMD4STRMSN**  
square, satin nickel

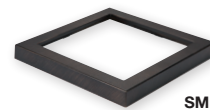

**SMD4STRMTBZ**  
square, tuscan bronze



**SMD4RTRMWH**  
round, white (paintable)



**SMD4RTRMSN**  
round, satin nickel



**SMD4RTRMTBZ**  
round, tuscan bronze

## HOUSING COMPATIBILITY

The SMD4 is UL Listed in Halo and All-Pro recessed housings, and is UL Classified for use with any 4 inch diameter recessed housing constructed of steel or aluminum with an internal volume that exceeds 62.3 in<sup>3</sup> in addition to those noted below:

Compatible Halo LED Housings with LED luminaire connector (high-efficacy compliant)		
HALO LED	Recessed Can Size	Catalog Number
		4"
Compatible Halo Incandescent E26 Screwbase Housings		
HALO	Recessed Can Size	Catalog Number
	4"	H99ICAT, H99TAT, H99RTAT, E4ICATSB, E4TATSB, E4RTATSB
Compatible All-Pro Incandescent E26 Screwbase Housings		
ALL-PRO	Recessed Can Size	Catalog Number
	4"	EI400ATSB, ET400ATSB, ET400RATSB

## COMPATIBLE WITH EATON'S CROUSE-HINDS JUNCTION BOXES

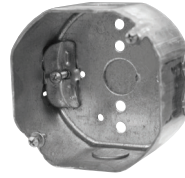

**TP316**  
for non-metallic cable  
4" x 4" x 2-1/8"  
(102mm x 102mm x 54mm)

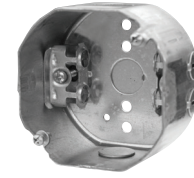

**TP317**  
for metal clad cable  
4" x 4" x 2-1/8"  
(102mm x 102mm x 54mm)

- **TP316** - for non-metallic cable
- **TP317** - for metal clad cable
- UL Listed
- Suitable for two-hour fire-rated ANSI/UL 263 when properly installed in a fire-rated ceiling or wall
- Refer to [www.crouse-hinds.com](http://www.crouse-hinds.com)

## COMPATIBLE WITH MANY OTHER JUNCTION BOXES\*



**4" octagon light fixture/fan steel box**  
4" x 4" x 2-1/8"  
(102mm x 102mm x 54mm)

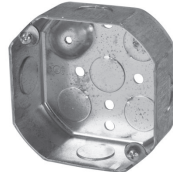

**4" octagon steel box**  
4" x 4" x 1-1/2"  
(102mm x 102mm x 38mm)



**4" square deep steel box**  
4" x 4" x 2-1/8"  
(102mm x 102mm x 54mm)



**4" square standard steel box**  
4" x 4" x 1-1/2"  
(102mm x 102mm x 38mm)



**4" round new work non-metallic light fixture/fan box**  
4" diameter x 2-3/16"  
(102mm x 56mm)



**3-1/2" round new work non-metallic ceiling box**  
3-1/2" diameter x 2-3/4"  
(89mm x 70mm)



**3-1/2" round old work non-metallic box**  
4-1/4" O.D. flange, 3-1/2" I.D. x 2-5/8"  
(108mm O.D., 89mm I.D. x 67mm)



**4" round surface mount box**  
4" diameter x 1-1/2"  
(102mm x 38mm)  
Requires SLD4RAD adapter



**4" round new work non-metallic box with hanger bar assembly**  
4" diameter x 2-3/16" (102mm x 56mm)

Surface mounting in a fire-rated ceiling using an appropriate electrical box offers a cost-effective alternative to fire-rated recessed housings.

**Note:** Fire-rating is per the rating of the ceiling and applicable junction box, not the SMD.

\*This is a representative list of compatible junction boxes only. Information contained in this literature about other manufacturers' products is from published information made available by the manufacturer and is deemed to be reliable, but has not been verified. Eaton makes no specific recommendation on product selection and there are no warranties of performance or compatibility implied. Installer must determine that site conditions are suitable to allow proper installation of the mounting bracket in the box.

## PHOTOMETRIC DATA

SMD4R6927WH		
Luminaire lumens		690
Input watts		9.5
LER (LPW)		73
Spacing Criteria	0-180	1.26
	90-270	1.26
	Diagonal	1.38
Beam angle (degrees)		112
Field angle (degrees)		162
Max. Candela		243
Zonal lumen	Lumens	% Lumens
0-30	187	27.2%
0-40	306	44.5%
0-60	542	78.6%
0-90	690	100.00%

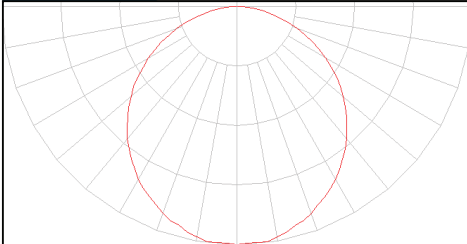

SMD4S6927WH		
Luminaire lumens		750
Input watts		9.5
LER (LPW)		79
Spacing Criteria	0-180	1.24
	90-270	1.24
	Diagonal	1.36
Beam angle (degrees)		109
Field angle (degrees)		162
Max. Candela		278
Zonal lumen	Lumens	% Lumens
0-30	207	27.6%
0-40	336	44.9%
0-60	589	78.6%
0-90	750	100.00%

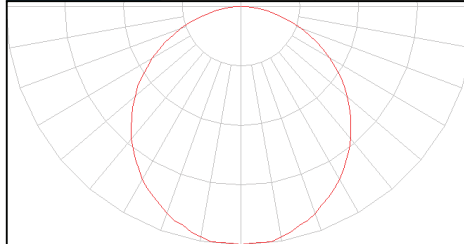

Cat. No.	CRI	CCT	Lumens	Power (W)	LPW
SMD4R6927WH	93	2700	690	9.50	72.6
SMD4R6930WH	93	3000	700	9.70	72.2
SMD4R6935WH	94	3500	740	9.70	76.3
SMD4R6940WH	94	4000	760	9.80	77.6
SMD4R6950WH	91	5000	786	9.70	81.0
SMD4S6927WH	92	2700	750	9.50	78.9
SMD4S6930WH	92	3000	790	9.90	79.8
SMD4S6935WH	93	3500	740	9.90	74.7
SMD4S6940WH	93	4000	800	10.10	79.2
SMD4S6950WH	90	5000	810	10.00	81.0

Foot-candle Values at Nadir 0 degree Aiming Angle			
DD (FT)	SMD4R6927WH (FC)	SMD4S6927WH (FC)	DIA (FT)
5.5	8.0	9.2	16.3
7	5.0	5.7	20.9
8	3.8	4.3	23.8
9	3.0	3.4	26.8
10	2.4	2.8	29.7
12	1.7	1.9	35.7

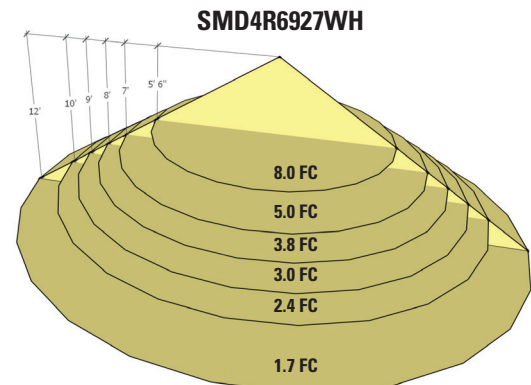

DD = distance down to illuminated work plane  
FC = initial foot-candles at nadir  
DIA = diameter

Multiplier Table					
CCT Option	2700K	3000K	3500K	4000K	5000K
CCT Multiplier	1.00	1.014	1.042	1.083	1.083

## DESCRIPTION

The Halo Surface Mount LED Downlight (SMD) is an low profile surface mounting luminaire with a modern look and high performance. SMD4 (4") is designed for installation in many 3-1/2" and 4" square, octagon, or round junction boxes. Supply wire adapter with LED quick wiring connector included. The SMD4 may also retrofit in 4" aperture IC and Non-IC recessed housings.

Catalog #		Type
Project		
Comments		Date
Prepared by		

## SPECIFICATION FEATURES

### HOUSING

- Non-electrically conductive polycarbonate frame.
- High impact diffuse polystyrene lens provides shielding to the light guide with no pixilation
- Stamped aluminum housing provides thermal cooling achieving L70 at 50,000 hours in IC and non-IC applications

### GASKETS

- Closed cell gasket achieves restrictive airflow and wet location requirements without additional caulking

### OPTICS

- Precision acrylic light guide organizes source flux into wide distribution with 1.2 – 1.4 spacing criteria useful for general area illumination

### LED

- Mid power led array provide a uniform source with high efficiency and long life.
- Available in 90 CRI minimum, R9 greater than 50 and color accuracy within 3 SDCM provide color accuracy and uniformity

### DRIVER

- Integral 120V 50/60Hz constant current driver provides noise free operation.
- Continuous, flicker-free dimming from 100% to 5% with select leading or trailing edge 120V phase cut dimmers.
- Dimming to 5% is best assured using dimmers with low end trim adjustment. Consult dimmer manufacturer for compatibility and conditions of use. (Note some dimmers require a neutral in the wallbox.)
- Inline electrical quick connect and E26 adapter (provided) provides mains connections.

### MOUNTING/RETENTION

- Adjustable spider plate allows for quick installation into both junction boxes and recessed housings.
- Torsion springs or friction blades included

### ELECTRICAL JUNCTION BOX MOUNTING

- The SMD may be used in compatible electrical junction boxes in direct contact with insulation including spray foam insulation.
- Suitable for installation in many 3-1/2" and 4" square, octagon, and round electrical junction boxes.
- Surface mounting in a fire-rated ceiling using an appropriate fire rated electrical box .  
Note: Fire-rating is per the rating of the ceiling and applicable junction box, not the SMD.
- Installer must ensure compatibility of fit, wiring and proper mounting in the electrical junction box. This includes all applicable national and local electrical and building coded

### RECESSED HOUSING MOUNTING

- May be installed in IC recessed housings in direct contact with insulation  
**Note:** Not for use in recessed housing in direct contact with spray foam insulation. Refer to NEMA LSD 57-2013.

### Friction Blade 4"

- Precision formed friction blades included
- For retrofit in 4" nominal housings
- Friction blade design allows the SMD to be installed in any position within the housing aperture (360 degrees)

### DESIGNER SKINS (SOLD SEPARATELY)

- SMD skins are accessory rings in both round and square. These skins attach to the SMD for a permanent finish. Refer to the SMD accessories specification sheet for details.
- Matte White (Paintable)
- Satin Nickel
- Tuscan Bronze

### WARRANTY

- Five year limited warranty, consult website for details.  
[www.eaton.com/lighting/legal](http://www.eaton.com/lighting/legal)

### COMPLIANCE

- cULus listed / certified for use with Halo housings, classified for use with other's housings, see instruction sheet for conditions of acceptability.
- Wet and Damp Location listed, airtight per ASTM-E283
- Suitable for use in clothes closets when installed in accordance with the NEC 410.16 spacing requirements.
- EMI/RFI emissions per FCC 47CFR Part 15B
- Contains no mercury or lead and RoHS compliant.
- Photometric testing in accordance with IES LM-79-08
- Lumen maintenance projections in accordance with IES LM-80-08 and TM-21-11.
- Can be used for State of California Title 24 high efficacy luminaire compliance, reference the California Energy Commission Title 20 Appliance Efficiency Database for current listings.
- Can be used for International Energy Conservation Coe (IECC) and Washington State Energy Code high efficiency luminaire compliance

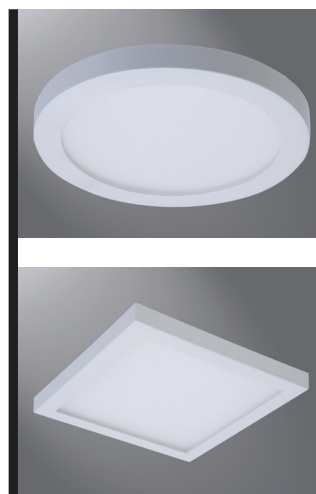

## SMD4 Series

4 inch Round and Square

**SMD4R  
SMD4S**

## 4" Surface Mount Downlight

**Suitable for ceiling or wall electrical junction boxes**

**Suitable for 4" recessed housing retrofit**

## ENERGY DATA

	Round	Square
Lumens (5000K models)	786	810
Input Power	9.7 W	10 W
Input Current	0.0811 A	0.0829 A
Efficiency	81 lm/W	81 lm/W
THD	13.3	13.2
Input Voltage	120V	
Frequency	50/60 Hz	
CRI	90 CRI	
Power Factor	0.99	
T Ambient	-30 - +40°C	
Sound Rating	Class A	



Refer to ENERGY STAR® Qualified Products List.  
Can be used to comply with California Title 24 High Efficacy requirements.  
Certified to California Appliance Efficiency Database under JA8.

## DIMENSIONS

SMD4RXXWH

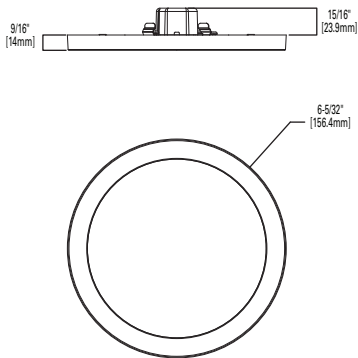

SMD4SXXWH

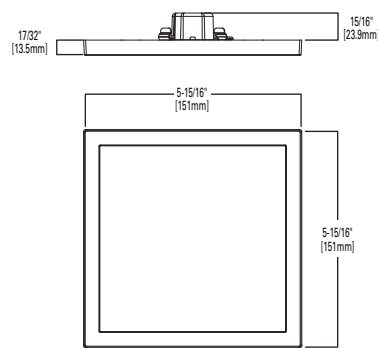

## ORDERING INFORMATION

**SAMPLE NUMBER:** SMD4R6930WH=4" Round Surface Mount Downlight, 90CRI, 3000K

**Junction Box Installation:** Order junction box separately, as supplied by others, to complete installation.

**Recessed Installation:** Order Halo recessed housing separately to complete installation.

Models	Lumens	CRI / CCT	Finish	Accessories
<b>SMD4R</b> = 4" Round Surface Mount Downlight, 120V <b>SMD4S</b> = 4" Square Surface Mount Downlight, 120V	<b>6</b> =600 lumen series	<b>927</b> =90CRI, 2700K <b>930</b> =90CRI, 3000K <b>935</b> =90CRI, 3500K <b>940</b> =90CRI, 4000K <b>950</b> =90CRI, 5000K	<b>WH</b> =Mate White	<u>Designer Trims</u> <b>SMD4RTRMSN</b> =4" Round SMD Satin Nickel <b>SMD4RTRMTBZ</b> =4" Round SMD Tuscan Bronze <b>SMD4RTRMWH</b> =4" Round SMD White (paintable)  <b>SMD4STRMSN</b> =4" Square SMD Satin Nickel <b>SMD4STRMTBZ</b> =4" Square SMD Tuscan Bronze <b>SMD4STRMWH</b> =4" Square SMD White (paintable)

## ACCESSORIES

### Designer Trims



**SMD4STRMWH**  
square, white (paintable)

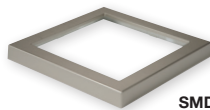

**SMD4STRMSN**  
square, satin nickel

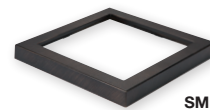

**SMD4STRMTBZ**  
square, tuscan bronze



**SMD4RTRMWH**  
round, white (paintable)



**SMD4RTRMSN**  
round, satin nickel



**SMD4RTRMTBZ**  
round, tuscan bronze



## HOUSING COMPATIBILITY

The SMD4 is UL Listed in Halo and All-Pro recessed housings, and is UL Classified for use with any 4 inch diameter recessed housing constructed of steel or aluminum with an internal volume that exceeds 62.3 in<sup>3</sup> in addition to those noted below:

Compatible Halo LED Housings with LED luminaire connector (high-efficacy compliant)		
HALO LED	Recessed Can Size	Catalog Number
		4"
Compatible Halo Incandescent E26 Screwbase Housings		
HALO	Recessed Can Size	Catalog Number
	4"	H99ICAT, H99TAT, H99RTAT, E4ICATSB, E4TATSB, E4RTATSB
Compatible All-Pro Incandescent E26 Screwbase Housings		
ALL-PRO	Recessed Can Size	Catalog Number
	4"	EI400ATSB, ET400ATSB, ET400RATSB

## COMPATIBLE WITH EATON'S CROUSE-HINDS JUNCTION BOXES

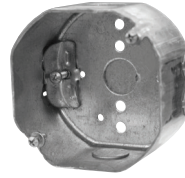

**TP316**  
for non-metallic cable  
4" x 4" x 2-1/8"  
(102mm x 102mm x 54mm)

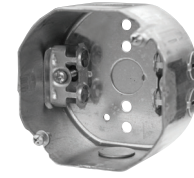

**TP317**  
for metal clad cable  
4" x 4" x 2-1/8"  
(102mm x 102mm x 54mm)

- **TP316** - for non-metallic cable
- **TP317** - for metal clad cable
- UL Listed
- Suitable for two-hour fire-rated ANSI/UL 263 when properly installed in a fire-rated ceiling or wall
- Refer to [www.crouse-hinds.com](http://www.crouse-hinds.com)

## COMPATIBLE WITH MANY OTHER JUNCTION BOXES\*



**4" octagon light fixture/fan steel box**  
4" x 4" x 2-1/8"  
(102mm x 102mm x 54mm)

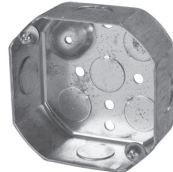

**4" octagon steel box**  
4" x 4" x 1-1/2"  
(102mm x 102mm x 38mm)

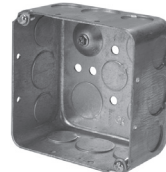

**4" square deep steel box**  
4" x 4" x 2-1/8"  
(102mm x 102mm x 54mm)



**4" square standard steel box**  
4" x 4" x 1-1/2"  
(102mm x 102mm x 38mm)



**4" round new work non-metallic light fixture/fan box**  
4" diameter x 2-3/16"  
(102mm x 56mm)



**3-1/2" round new work non-metallic ceiling box**  
3-1/2" diameter x 2-3/4"  
(89mm x 70mm)



**3-1/2" round old work non-metallic box**  
4-1/4" O.D. flange, 3-1/2" I.D. x 2-5/8"  
(108mm O.D., 89mm I.D. x 67mm)



**4" round surface mount box**  
4" diameter x 1-1/2"  
(102mm x 38mm)  
Requires SLD4RAD adapter



**4" round new work non-metallic box with hanger bar assembly**  
4" diameter x 2-3/16" (102mm x 56mm)

Surface mounting in a fire-rated ceiling using an appropriate electrical box offers a cost-effective alternative to fire-rated recessed housings.

**Note:** Fire-rating is per the rating of the ceiling and applicable junction box, not the SMD.

\*This is a representative list of compatible junction boxes only. Information contained in this literature about other manufacturers' products is from published information made available by the manufacturer and is deemed to be reliable, but has not been verified. Eaton makes no specific recommendation on product selection and there are no warranties of performance or compatibility implied. Installer must determine that site conditions are suitable to allow proper installation of the mounting bracket in the box.

## PHOTOMETRIC DATA

SMD4R6927WH		
Luminaire lumens		690
Input watts		9.5
LER (LPW)		73
Spacing Criteria	0-180	1.26
	90-270	1.26
	Diagonal	1.38
Beam angle (degrees)		112
Field angle (degrees)		162
Max. Candela		243
Zonal lumen	Lumens	% Lumens
0-30	187	27.2%
0-40	306	44.5%
0-60	542	78.6%
0-90	690	100.00%

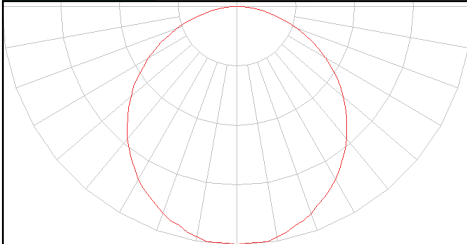

SMD4S6927WH		
Luminaire lumens		750
Input watts		9.5
LER (LPW)		79
Spacing Criteria	0-180	1.24
	90-270	1.24
	Diagonal	1.36
Beam angle (degrees)		109
Field angle (degrees)		162
Max. Candela		278
Zonal lumen	Lumens	% Lumens
0-30	207	27.6%
0-40	336	44.9%
0-60	589	78.6%
0-90	750	100.00%

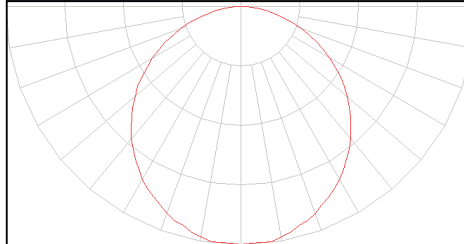

Cat. No.	CRI	CCT	Lumens	Power (W)	LPW
SMD4R6927WH	93	2700	690	9.50	72.6
SMD4R6930WH	93	3000	700	9.70	72.2
SMD4R6935WH	94	3500	740	9.70	76.3
SMD4R6940WH	94	4000	760	9.80	77.6
SMD4R6950WH	91	5000	786	9.70	81.0
SMD4S6927WH	92	2700	750	9.50	78.9
SMD4S6930WH	92	3000	790	9.90	79.8
SMD4S6935WH	93	3500	740	9.90	74.7
SMD4S6940WH	93	4000	800	10.10	79.2
SMD4S6950WH	90	5000	810	10.00	81.0

Foot-candle Values at Nadir 0 degree Aiming Angle			
DD (FT)	SMD4R6927WH (FC)	SMD4S6927WH (FC)	DIA (FT)
5.5	8.0	9.2	16.3
7	5.0	5.7	20.9
8	3.8	4.3	23.8
9	3.0	3.4	26.8
10	2.4	2.8	29.7
12	1.7	1.9	35.7

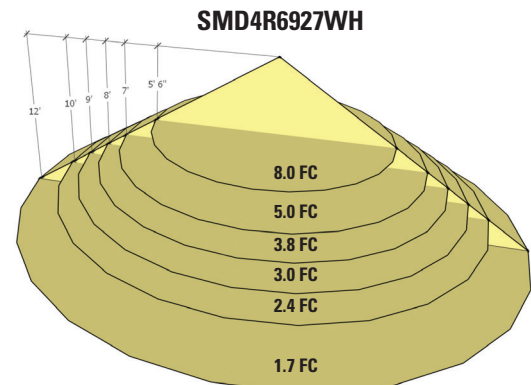

DD = distance down to illuminated work plane  
FC = initial foot-candles at nadir  
DIA = diameter

Multiplier Table					
CCT Option	2700K	3000K	3500K	4000K	5000K
CCT Multiplier	1.00	1.014	1.042	1.083	1.083