

The Industry Standard In Two-Piece Steel Raceway

Available Factory Prewired

4000® Series Raceway is the work horse of surface raceway systems. 4000 Series Raceway can be divided for multi-service applications making it ideal for applications requiring a large cable capacity and dual-service requirements. Commercial, institutional, and industrial applications benefit from the rigid steel construction and durable ScuffCoat™ finish of this raceway. 4000 Series Raceway is also ideal for municipalities that have code requirements calling for all steel construction or that prohibit nonmetallic cable management systems.

4000 Series Raceway Used in a training room application.



FEATURES & BENEFITS

- **New 4075D Series Bridge Fittings.** Provides ability to bridge over existing 4000, 2400, 700, and 500 Series Raceways.
- **New 4047 Faceplates.** One-piece device bracket with overlapping cover design that hides bad cuts and unsightly seams where device plates abut raceway covers.
- **New 4047-2 Faceplates.** Same great features as the 4047 faceplates, but now available in a double-wide 4-gang version.
- **4047 faceplates available with pre-pigtailed receptacle installed.** 20A heavy duty commercial grade duplex receptacle with 12" (305mm) pigtailed pre-installed in the device bracket. Saves time and labor.
- **FiberReady 2" (51mm) Fiber Optic Radius fittings.** UL and cUL verified and exceed the recommendations of TIA/EIA 569A. Available as full capacity fittings or inserts to be used for existing installations.
- **Large cross section area.** Provides ample space for large wiring requirements.
- **Complete line of fittings.** Provides complete wiring solution and allows for interconnection between raceway systems.
- **Gray baked enamel and Ivory ScuffCoat™ finish.** Durable ivory Scuffcoat finish makes a scratch resistant surface.
- **Feeder or header system.** Ideal for overhead, open spaces and under raised floor applications.
- **Pre-cut covers.** For mounting devices on various centers without cutting the covers. Use with 4046, 4047, 4048, 4007, and 4049 Series device plates.
- **4050 nonmetallic device plates.** Overlapping design offers an aesthetically pleasing way to cover seams. Available in gray or ivory.
- **Base and cover cutters.** Manually operated cutters are lightweight and portable. Cutters offer labor savings for any size job and maintain a factory clean and square end cut.
- **Available prewired.** Manufactured to specified job site lengths and ready to install. Jobs can be packaged by area, floor, or building and shipped per job site requirements.
- **Simple prewired ordering.** Provide us with marked-up electrical drawings and electrical/communications specifications and shipments can begin within three to four weeks or less for most jobs.
- **Datacom connectivity options.** Accepts industry standard and proprietary devices from a wide range of manufacturers to provide a seamless and aesthetically pleasing interface for voice, data, audio, and video applications at the point of use.
- **UL5 and ADA compliant.** Raceway and fittings meet UL5 standards and can be installed in conformance with ADA requirements.
- **UL Listed multioutlet assemblies.** File E68073 Guide PVGT. Fittings: File E121188 Guide RJPR. Meets Article 380 of NEC and meets Section 12-3023 of CEC.
- **cULus Listed Surface Metal Raceway System.** File E4376 Guide RJBT. Fittings: File E41751, Guide RJPR. Meets Article 386 of NEC and meets Section 12-1600 of CEC.

NEW!

Now compatible with A/V devices.

4000 Series Raceway System Layout



NOTE: Illustration is for showing product applications only.

4000 Series Raceway Ordering Information

Catalog No./Item	Description/Specifications	Catalog No./Item	Description/Specifications
V4000B-10 G4000B-10 	Base – .050" galvanized steel Packed five 10' (3.050m) lengths per carton. Base has two 9/32" (7.1mm) diameter KOs on centers of approximately 18" (457mm) throughout.	V4000C315 G4000C315 	31.5" (775mm) Pre-Cut Cover – For mounting devices on 36" (915mm) centers with 4007, 4046, 4047, 4048, and 4050 Series plates. Spacing will be 36 1/4" (mm) with 4050.
V4000C G4000C 	Cover – .040" (1.0mm) galvanized steel. Packed ten 5' (1.5m) lengths per carton.	G4000D 	Divider – .040" (1.0mm) galvanized steel. One side painted buff primer to provide identification of compartments.* Packed ten 5' (1.5m) lengths (50' (15.2m)) per carton. NOTE: 4001DA Divider Clips are required to hold divider in place.
V4000C075 G4000C075 	7.5" (191mm) Pre-Cut Cover – For mounting devices on 12" (305mm) centers with 4007, 4046, 4047, 4048, and 4050 Series plates. Spacing will be 12 1/4" (311mm) with 4050.	IWE-S GWE-S 	Spray Paint – Used for touching up large areas. Contains 12 oz. of paint. NOTE: Can only be shipped via ground transportation.
V4000C135 G4000C135 	13.5" (343mm) Pre-Cut Cover – For mounting devices on 18" (457mm) centers with 4007, 4046, 4047, 4048, and 4050 Series plates. Spacing will be 18 1/4" (464mm) with 4050.	IWE-P GWE-P 	Touch-Up Paint Pen – Used for touching up small areas. Contains 0.3 oz. of paint.
V4000C195 G4000C195 	19.5" (496mm) Pre-Cut Cover – For mounting devices on 24" (610mm) centers with 4007, 4046, 4047, 4048, and 4050 Series plates. Spacing will be 24 1/4" (616mm) with 4050.		



Download this product's PEP ecopassport® environmental product declaration at www.legrand.us/resources-and-downloads. This declaration conforms with ISO 14025 and 14040 and is in alignment with EN 15804.

4000 Series Raceway Fittings Ordering Information

Catalog No./Item	Description/Specifications	Catalog No./Item	Description/Specifications
G4000WC 	Wire Clip (Plated) – For holding conductors in place.	V4010DFO G4010DFO 	Divided Entrance End Fitting – Has concentric 3/4", 1", and 1 1/4" trade size KOs on end and bottom for feeding 4000 Raceway. Furnished with removable divider and 1 1/4" (32mm) bend radius controlled insert.
4001A 	Coupling (Galvanized Steel Plated) – For joining lengths of G4000B. Sold in pairs.	V4011FO G4011FO 	FiberReady 2" (51mm) Radius Full Capacity Flat Elbow – A 90° flat corner for divided and undivided applications for new lay-in or pull-through installations.
4011DRI 	2" (51mm) Radius Insert for Divided Flat Elbow – Insert for V/G4011 Flat Elbow that provides a 2" (51mm) bend radius for UTP/STP or fiber optic cable installations.	V4011 G4011 	Flat Elbow – For right angle turns on the same surface.
4015DRI 	2" (51mm) Radius Insert for Divided Tee – Insert for V/G4015D Divided Tee that provides a 2" (51mm) bend radius for UTP/STP or fiber optic cable installations.	V4012TX G4012TX 	Internal or External 45° Elbow – Can also be assembled as an inverted 45° elbow. NOTE: Shown assembled as internal elbow.
4011/15RI 	2" (51mm) Radius Corner Insert – Insert for V/G4015 Undivided Tee that provides a 2" (51mm) bend radius for UTP/STP or fiber optic cable installations.	V4014A G4014A 	Wall Box Connector – Base has two concentric 1/2", 3/4", 1", and 1 1/4" trade size KOs, and two rectangular 2 9/16" x 1 11/16" (65mm x 43mm) KOs.
4017/18RI 	2" (51mm) Radius Insert for Internal/External Elbows – Insert for V/G4017 Internal Elbow and for V/G4018 External Elbow that provides a 2" (51mm) bend radius for UTP/STP or fiber optic cable installations.	V4015 G4015 	Full Capacity Tee – For undivided raceway only. Join to raceway run with G4001 Couplings (not furnished).
4001DA 	Divider Clip (Plated) – Required for holding G4000D Divider in place. Use one every 2 1/2' (0.762m).	V4015D G4015D 	Divided Tee – For divided raceway only. Join to raceway run with G4001 Couplings (not furnished).
V4010B G4010B 	Blank End – For closing open end of 4000 Base. Has two 1/2" trade size KOs.	V4015FO G4015FO 	FiberReady 2" (51mm) Radius Full Capacity Tee – A full capacity undivided tee fitting. For new lay-in or pull-through installations.

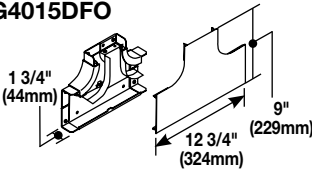
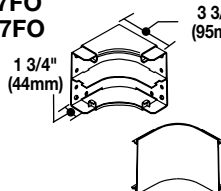
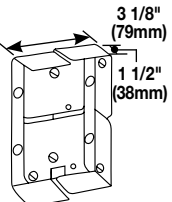
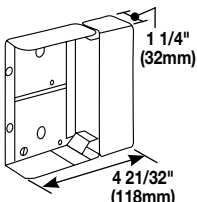
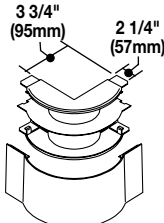
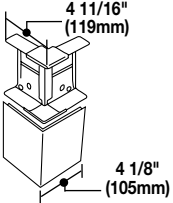
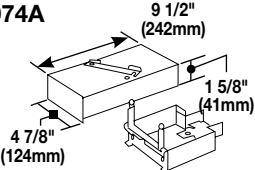
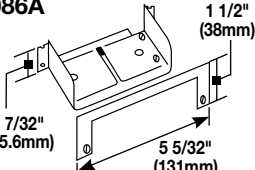

4000 Series Raceway Fittings Ordering Information (continued)

Catalog No./Item	Description/Specifications
V4015DFO G4015DFO	FiberReady 2" (51mm) Radius Full Capacity Tee – A full capacity divided tee fitting. For new lay-in or pull-through installations.
	
V4017FO G4017FO	FiberReady 2" (51mm) Radius Full Capacity Internal Elbow – Full capacity 90° internal corner for divided or undivided applications. For new installations.
	
V4017 G4017	Internal Elbow – For 90° internal corners. Fiber bushing included.
	
V4017N G4017N	Inverted Internal Elbow – For connecting a vertical run of 4000 Raceway with a horizontal overhead run with its cover facing up.
	
V4018FO G4018FO	FiberReady 2" (51mm) Radius Full Capacity External Elbow – Use in divided or undivided applications. For new lay-in or pull-through installations.
	
V4018 G4018	External Elbow – For 90° external corners.
	
G4074A	Take-Off Connector (4000 to 3000) – For connecting a 90° tee at any point along a run of 4000 Raceway.
	
G4086A	Panel Connector – For connecting 4000 Raceway with surface type panel boxes. Accommodates maximum wire capacity of 4000 System. C-shaped flange covers uneven cuts to the box.
	

Catalog No./Item	Description/Specifications
G4017TCA	Internal Corner Coupling (Plated) – For making an internal corner while continuing a straight run. May be used with or without divider. A 4010B Blank End Fitting is required for an internal elbow. Fiber Bushing included.
	
V4075D G4075D	Bridge Fitting – Allows 4000 Series Raceway to bridge over existing 4000 Series Raceway installations.
	
V4075DA G4075DA	Bridge Fitting – Allows 4000 Series Raceway to bridge over existing 2400, 700, or 500 Series Raceway installations.
	

* Faceplates can also be used with 6000 Series Raceway.
 ✦ Add "C" prefix to denote Canadian version – Agency approved for sale in Canada. ©

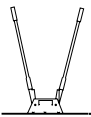
4000 Series Raceway Cutters

Catalog No./Item	Description/Specifications
640B	Base Cutter – Portable base cutter. Steel constructed provides clean and easy square cuts. Manual operation required.
	
640BDK	Replacement Blade Kit – Replacement blade and die set for 640B Cutter.
640C	Cover Cutter – Portable cover cutter. Steel constructed provides clean and easy square cuts. Manual operation required.
	
640CDK	Replacement Blade Kit – Replacement blade and die set for 640C Cutter.



New 4047 Faceplates accommodate a wide range of power and communications applications.

4047 Series Cover Plates Ordering Information

Catalog No./Item	Description/Specifications	Catalog No./Item	Description/Specifications
V4047AX G4047AX 	Two-Gang Overlapping Cover Single Round Opening – For straight blade and locking single receptacles with face diameters of 1.38" to 1.39" (35mm to 36mm).	V4047C-1 G4047C-1 	One-Gang Overlapping Device Plate – Use with commercially available single-gang flush plate (sold separately).
V4047BX G4047BX 	Two-Gang Overlapping Cover Duplex Receptacle – For 15A and 20A duplex receptacles. Accepts 106 Communications Duplex Frame.	V4047C-2 G4047C-2 	Two-Gang Overlapping Device Plate – Use with commercially available two-gang flush plate (sold separately).
V4047BB G4047BB 	Two-Gang Overlapping Cover Two Duplex Receptacles – For 15A and 20A duplex receptacles. Accepts 106 Communications Duplex Frame.	V4047JX G4047JX 	Two-Gang Overlapping Cover Single Round Opening – For straight blade and single locking receptacles with face diameters of 1.56" – 1.58" (39mm – 40mm).
V4047BF G4047BF 	Two-Gang Overlapping Cover Duplex & Modular Furniture – For 15A and 20A duplex receptacles. Includes combination Modular Furniture and two Keystone twistouts. Accepts modular furniture adapter, 106 Communications Duplex Frame or RJ45.	V4047RX G4047RX 	Two-Gang Overlapping Cover Rectangle Opening – For rectangular GFCI, Surge and decorator style devices. Does not accept 5507 Series Faceplates.
V4047BM G4047BM 	Two-Gang Overlapping Cover Duplex & 2A Mini adapter – For 15A and 20A duplex receptacles. Includes Mini adapter. Accepts 106 Communications Duplex Frame, Activate inserts & Wiremold Open System Communication Modules.	V4047RF G4047RF 	Two-Gang Overlapping Cover Rectangle Opening & Modular Furniture – For rectangular GFCI, Surge and decorator style devices. Does not accept 5507 Series Faceplates. Accepts modular furniture adapter and RJ45.
V4047BS G4047BS 	Two-Gang Overlapping Cover Duplex & Series II Mini Adapter – For 15A and 20A duplex receptacles. Includes Mini adapter. Accepts 106 Communications Duplex Frame or one Ortronics® Series II Communications Insert.	V4047WX G4047WX 	Two-Gang Overlapping Cover with One Duplex Receptacle Installed – Includes one Pass & Seymour Duplex Receptacle with 12" wire leads installed on bracket.
V4047BT G4047BT 	Two-Gang Overlapping Cover Duplex & TracJack Mini Adapter – For 15A and 20A duplex receptacles. Includes Mini adapter. Accepts 106 Communications Duplex Frame or two Ortronics® TracJack Communications Inserts.		

NOTE: Faceplates can also be used with 6000 Series Raceway.

➤ Add "C" prefix to denote Canadian version – UL Listed to U.S. and Canadian Safety Standards. ©-

4047 Series Cover Plates Ordering Information (continued)

Catalog No./Item	Description/Specifications	Catalog No./Item	Description/Specifications
V4047WF  G4047WF  	Two-Gang Overlapping Cover with One Duplex Installed & Modular Furniture Opening – Includes one Pass & Seymour 20 A Duplex Receptacle with 12" wire leads installed on bracket. Includes combination Modular Furniture and 2 Keystone Twist Out. Accepts modular furniture adapter and RJ45.	V4047-2BBMM  G4047-2BBMM  	Four-Gang Overlapping Cover Two Duplex & Two Activate Mini Adapters – For 15A and 20A duplex receptacles. Includes Mini adapter. Accepts 106 Communication Duplex Frame, Activate inserts & Wiremold Open System Communications Modules.
V4047WM  G4047WM  	Two-Gang Overlapping Cover with One Duplex Installed & Activate Mini adapter – Includes one Pass & Seymour 20A Duplex Receptacle with 12" wire leads installed on Bracket. Includes Mini adapter. Accepts Activate inserts & Wiremold Open System Communication Modules.	V4047-2BBSS  G4047-2BBSS  	Four-Gang Overlapping Cover Two Duplex & Two Series II Mini Adapters – For 15A and 20A duplex receptacles. Includes Mini adapter. Accepts 106 Communication Duplex Frame or one Ortronics® Series II Communication insert.
V4047WS  G4047WS  	Two-Gang Overlapping Cover with One Duplex Installed & Series II Mini adapter – Includes one Pass & Seymour 20A Duplex Receptacle with 12" wire leads installed on Bracket. Includes Mini adapter. Accepts one Ortronics® Series II Communications insert.	V4047-2BBTT  G4047-2BBTT  	Four-Gang Overlapping Cover Two Duplex & Two TracJack Mini Adapters – For 15A and 20A duplex receptacles. Includes Mini adapter. Accepts 106 Communication Duplex Frame or two Ortronics® TracJack Communications inserts.
V4047WT  G4047WT  	Two-Gang Overlapping Cover with One Duplex Installed & TracJack Mini adapter – Includes one Pass & Seymour 20A Duplex Receptacle with 12" wire leads installed on Bracket. Includes Mini adapter. Accepts two Ortronics® TracJack Communications inserts.	V4047-2BBXX  G4047-2BBXX  	Four-Gang Overlapping Cover with Two Duplex Openings – For 15A and 20A duplex receptacles. Accepts 106 Communication Duplex Frame.
V4047-2BBBB  G4047-2BBBB  	Four-Gang Overlapping Cover Four Duplex Openings – For 15A and 20A duplex receptacles. Accepts 106 Communication Duplex Frame.	V4047-2RRXX  G4047-2RRXX  	Four-Gang Overlapping Cover Two Rectangular Openings – For rectangular, GFCI, Surge and decorator style devices. Does not accept 5507 Series Faceplates.
V4047-2BBFF  G4047-2BBFF  	Four-Gang Overlapping Cover Two Duplex & Two Modular Furniture Openings – For 15A and 20A duplex receptacles. Includes combination Modular Furniture & two Keystone Twistouts. Accepts 106 Communication Duplex Frame, RJ45 or modular furniture adapter.	V4047-2WWFF  G4047-2WWFF  	Four-Gang Overlapping Cover Two Duplex Installed & Two Modular Furniture Openings – Includes two, Pass & Seymour 20A Duplex Receptacles with 12" wire leads installed on Bracket. Includes combination Modular Furniture & four keystone Twistouts. Accepts modular furniture adapter or RJ45.

NOTE: Faceplates can also be used with 6000 Series Raceway.
 ✦ Add "C" prefix to denote Canadian version – UL Listed to U.S. and Canadian Safety Standards. 

4047 Series Cover Plates Ordering Information (continued)

Catalog No./Item	Description/Specifications	Catalog No./Item	Description/Specifications
V4047-2WWMM G4047-2WWMM	Four-Gang Overlapping Cover with Two Duplex Installed & Two Activate Mini Adapters – Includes two Pass & Seymour 20A Duplex Receptacle with 12" wire leads installed on Bracket. Includes Mini adapter. Accepts two Activate inserts & Wiremold Open System Communication Modules.	V4047-2WWXX G4047-2WWXX	Four-Gang Overlapping Cover with Two Duplex Receptacles Installed – Includes two Pass & Seymour 20A Duplex Receptacles with 12" wire leads installed on Bracket.
V4047-2WWSS G4047-2WWSS	Four-Gang Overlapping Cover with Two Duplex Installed & Two Series II Mini Adapters – Includes two Pass & Seymour 20A Duplex Receptacles with 12" wire leads installed on Bracket. Includes Mini adapter. Accepts two Ortronics® Series II Communication inserts	V4047UX G4047UX	Bump-Up Extron® MAAP Device Plate – Accepts four Extron® Electronics MAAP single space modules.
V4047-2WWTT G4047-2WWTT	Four-Gang Overlapping Cover with Two Duplex Installed & Two TracJack Mini Adapters – Includes two Pass & Seymour 20A Duplex Receptacles with 12" wire leads installed on Bracket. Includes Mini adapter. Accepts four Ortronics® TracJack Communications inserts.	V4047VX G4047VX	Bump-Up Extron® AAP Device Plate – Accepts two Extron® Electronics AAP single space modules.

NOTE: Faceplates can also be used with 6000 Series Raceway.
 Add "C" prefix to denote Canadian version – UL Listed to U.S. and Canadian Safety Standards.

4047 Series Configurable Cover Plates Number Logic

1. For "X", Choose one of the following options:

V Ivory & UL Listed
G Gray & UL Listed

CV Ivory & cULus Listed (Canada only)
CG Gray & cULus Listed (Canada only)

2. Choose a Plate Configuration:

Two-Gang Plate:

X 4047 Y Y
 1 2

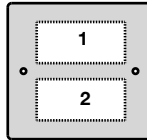

Four-Gang Plate:

X 4047-2 Y Y Y Y
 1 2 3 4



3. For "Y", Choose any combination of configurations from the options listed below:

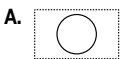

1.41" (35.8mm) Diameter, Single Round Receptacle

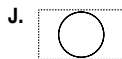

1.59" (40mm) Diameter, Single Round Receptacle



Ortronics TracJack 2A Mini Adapter Adapter Opening with Adapter



Duplex Receptacle Opening



Pass & Seymour Activate 2A Mini adapter Opening with Adapter



Pass & Seymour Light Almond 20 Amp Receptacle pre-pigtailed with 12" wire leads installed on Bracket

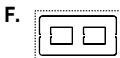

Combination Modular Furniture & 2 Keystone Twist Out

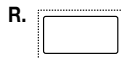

Rectangular Receptacle

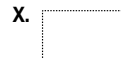

Blank

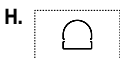

Mouse Hole Twist Out & Grommet

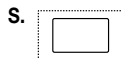

Ortronics Series II 2A Mini adapter Opening with Adapter

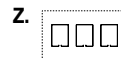

3 Keystone Twist Out

4. Finished Part Number

_ 4047 _ _ _ 4047-2 _ _ _ _

NOTE: For additional colors or configurations, call 1-800-621-0049, option 2.

4000 Series Raceway Faceplates Ordering Information

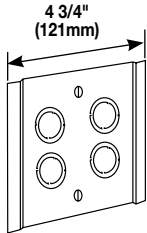
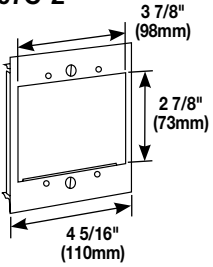
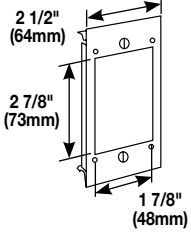
Catalog No./Item	Description/Specifications	Catalog No./Item	Description/Specifications
V4046H-2 G4046H-2	Tap-Off Fitting – Has four concentric 1/2" and 3/4" trade size KOs.	V6007C-2 G6007C-2	Two-Gang Device Plate – For installing two-gang devices or two vertically mounted single-gang devices on undivided raceway. <ul style="list-style-type: none"> • Accepts commercially available wall plate (not furnished).
			
V6007C-1 G6007C-1	Single-Gang Device Cover – For vertical mounting of single-gang devices on undivided raceway. Accepts commercially available wall plate. (sold separately)		
			

NOTE: Faceplates can also be used with 6000 Series Raceway.
 ✦ Add "C" prefix to denote Canadian version – UL Listed to U.S. and Canadian Safety Standards. (UL)

Communication Endplates Ordering Information

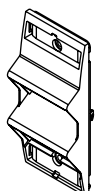
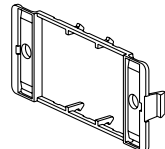
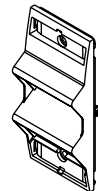
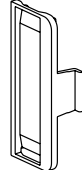
Catalog No./Item	Description/Specifications	Catalog No./Item	Description/Specifications
ARA-S2	Angled Raceway Adapter – For use with multi-channel raceway device brackets and WallSource device mounting brackets. Angled exit provides additional mounting depth required for A/V connections as well as ensuring the required bend radius for UTP and fiber optic cabling. Holds two Ortronics® Series II modules. Fits 5507 Series Faceplate opening.	CM-EPLA*	End Plates – Includes two outlet identification labels with clear covers and two matching screw covers. Required for mounting Pass & Seymour Activate and Wiremold Open System communication modules into 4050 Series device brackets.
			
CM-ARA	Angled Raceway Adapter – For use with multi-channel raceway device brackets and WallSource device mounting brackets. Angled exit provides additional mounting depth required for A/V connections as well as ensuring the required bend radius for UTP and fiber optic cabling. Holds two CM2 Series modules or two Pass & Seymour® 2A inserts. Fits 5507 Series Faceplate opening.	S2-EPL*	End Plates – Includes two outlet identification labels with clear covers and two matching screw covers. Required for mounting Ortronics Series II modules into 4050 Series device brackets.
			

V/G4050 & 5507 Series Faceplates Ordering Information

Catalog No./Item	Description/Specifications	Catalog No./Item	Description/Specifications
V4050* G4050* 	Device Mounting Bracket – High impact plastic mounting bracket and trim plate which overlap raceway cover providing a seamless transition. For use with 5507 Series Faceplates, Ortronics® TracJack & Series II Modules, Pass & Seymour Activate Series Inserts, and Wiremold Open System Communication Modules.	5507T1* 	Single Receptacle Faceplate – For covering single receptacles – 1.59" (40.4mm) diameter.
5507AD* 	Modular Furniture Adapter – For mounting Pass & Seymour Activate modular furniture adapter and other modular furniture adapters.	5507T2* 	Single Receptacle Faceplate – For covering single receptacles – 1.41" (35.8mm) diameter.
5507B* 	Blank Faceplate – For covering unused compartments in the device bracket.	5507RJ* 	Dual RJ11/RJ45 Connector Faceplate – For mounting one or two RJ type keystone connectors – has one opening and a KO for the other.
5507D* 	Duplex Faceplate – For covering duplex style devices. Accepts 106 Communication Duplex Frame.	5507FRJ* 	Flush Dual RJ11/RJ45 Faceplate – Same as 5507RJ except the connectors are recessed to provide a flush installation.
5507R* 	Rectangular Faceplate – For covering rectangular style devices.	5507AAP 	Extron® AAP Faceplate – Accepts two Extron® Electronics AAP single space modules. NEW!
5507S* 	Rectangular Spacer – For mounting commercial device plates. Installs between the device bracket and a device.	5507MAAP 	Extron® MAAP Faceplate – Accepts two Extron® Electronics MAAP single space modules. NEW!
5507SW* 	Switch Faceplate – For covering standard toggle switches.	5507-4TJ* 	Ortronics Faceplate – For mounting Ortronics® communication inserts. Accepts four TracJack Devices.
		5507-6TJ* 	Ortronics Faceplate – For mounting Ortronics® communication inserts. Accepts six TracJack Devices.

NOTE: All faceplates are 4 1/4" long x 1 11/16" wide (108mm x 43mm).

* Add "G" suffix to indicate gray finish.

Not for use with 4048BF and 4048RF Device Covers.

4000 Series Prewired Steel Raceway Features

FEATURES	STANDARD	OPTIONS
Communication Devices	Ortronics or Pass & Seymour Activate Connectivity System Devices	Other manufacturers
Electrical Devices	Pass & Seymour	Other manufacturers and some International devices
Base Length	Longest = 10' (2.54m), shortest = 1' (305mm)	—
Installation	Surface mounted	—
Finish	Baked enamel finish custom colors	Standard colors of baked powder epoxy or
Wire Type	THHN stranded	Options per specification
Wiring Splices	Insulation displacement connectors	Continuous wiring or twist-on wire connector
Grounding Conductors	Wire gauge per National Electrical Code (NEC) and shared grounding wires	Oversized and/or separate grounding wires
Device Identification	Gray self-adhesive polyester label with black letters	Self-adhesive engraved nameplate
Neutrals	Shared neutral	Oversized and/or separate neutral wires
Pigtails	12" (305mm) feeds and receptacle leads	Per specification
Conduit Feeds	Raceway drilled at job site	Entrance end cap
Device Mounting	Nonmetallic plates	Steel plates
Record Drawings	3 sets and 2 copies of marked-up blueprints	Per job requirements
Submittal Services	Detailed submittal	Submittal free

Device and Raceway Labeling Detail for Prewired Applications

- Device labeling is available in the following materials:
 - Gray self-adhesive polyester label with black lettering (standard).
 - Other color self-adhesive polyester labels.
 - Engraved phenolic nameplates with adhesive backing.
- The back of the raceway is labeled with the raceway number and the room or area number(s).



Labeling detail using the steel device plates.



Labeling detail using the nonmetallic 4050 Device Plates. (Shown with Pass & Seymour Activate connectivity inserts).

4000 Series Ordering Specifications for Prewired Applications

Two options available when ordering a prewired job:

- 1. Detailed Submittal** The detailed submittal will show exactly how each raceway run will be built including lengths, number and type of receptacles, wiring schematics, circuiting information, etc. The contractor and/or distributor must review, clarify any information not clearly indicated on the drawings or specs, approve, and return to the factory before production can begin.
- 2. Submittal Free** The Prewired Express Building Plan Checklist is filled out by the contractor or distributor and sent along with plans, casework, and specs to the factory. No submittal is required and the project is scheduled for production upon receipt of all necessary information.

4000 Series Raceway Wire Fill Capacity Charts

4000 Series Raceway Wire Fill Capacities for Power

WIRE SIZE THHN/THWN	O.D. Inches (mm)		NUMBER OF CONDUCTORS (40% FILL)							
			WITHOUT DEVICES		WITH DUPLEX RECT. DEVICES 1.59 IN ² (1025mm ²)		WITH SURGE/ GFCI DEVICES 2.30 IN ² (1485mm ²)		LARGE SINGLE RECEPTACLES 3.00 IN ² (1935mm ²)	
			UNDIV.	DIVIDED	UNDIV.	DIVIDED	UNDIV.	DIVIDED	UNDIV.	DIVIDED
14 AWG	0.111	(2.8)	296	127	165	78	107	49	49	20
12 AWG	0.130	(3.3)	216	93	120	57	78	36	36	15
10 AWG	0.164	(4.2)	136	58	76	36	49	22	22	9
8 AWG	0.216	(5.5)	78	33	43	20	28	13	13	5
6 AWG	0.254	(6.5)	56	24	31	15	20	9	9	3
4 AWG	0.324	(8.2)	34	15	0	0	0	0	0	0
3 AWG	0.352	(8.9)	29	12	0	0	0	0	0	0
2 AWG	0.384	(9.8)	24	10	0	0	0	0	0	0

* For additional information, refer to section T1 of the current version of catalog ED1560 (Product Guide)

4000 Series Raceway Wire Fill Capacities for Communications

	CABLE/WIRE SIZE	O.D.		DIVIDED 40% FILL*	UNDIVIDED 40% FILL*
		Inches	(mm)		
UNSHIELDED TWISTED PAIR	4-pair, 24 AWG, Cat 3	0.190	(4.8)	49	101
	4-pair, 24 AWG, Cat 5e	0.210	(5.3)	40	83
	4-pair, 24 AWG, Cat 6	0.250	(6.3)	28	58
	4-pair, 24 AWG, Cat 6a*	0.354	(3.6)	14	29
	25-pair, 24 AWG	0.410	(10.4)	10	21
COAXIAL	RG6/U	0.270	(6.9)	24	50
FIBER	ZipCord	0.118 x 0.236(3 x 6)		50	103
	Round 4 Strand Fiber	0.187	(4.8)	51	104
	Round 6 Strand Fiber	0.256	(6.5)	27	55

* Category 6 augmented (6a) cable for 10 gigabit ethernet - max allowed cable diameter per addenda No. 11 ANSI TIA/EIA 568-B.2.

4000 Raceway Wire Fill Capacities When Using 4000 Radius Inserts

	CABLE/WIRE SIZE	4011 FLAT ELBOW O.D.		4017 & 4018 ELBOWS 40% FILL		4015D & 4015 TEE FITTINGS 40% FILL		40% FILL	
		Inches	(mm)	4011DRI	4011/4015RI	4017/18RI	4017/18RI	4015DRI	4011/15RI
				Divided	Undivided	Divided	Undivided	Divided	Undivided
POWER WIRING THHN/THWN	2 AWG	0.384	(9.8)	11	21	6	11	6	16
	4 AWG	0.324	(8.2)	15	30	8	15	9	23
	6 AWG	0.254	(6.5)	24	48	13	25	14	37
	8 AWG	0.216	(5.5)	34	67	18	35	20	51
	10 AWG	0.164	(4.2)	68	136	36	71	40	104
	12 AWG	0.130	(3.3)	107	214	56	112	63	163
	14 AWG	0.111	(2.8)	145	288	75	151	85	220
UNSHIELDED TWISTED PAIR	Cat. 3 UTP	0.190	(4.8)	44	88	23	46	26	67
	Cat. 5e UTP	0.210	(5.3)	36	72	19	38	21	55
	Cat. 6 UTP	0.250	(6.3)	23	47	12	24	13	36
	Cat. 6a UTP	0.354	(9.0)	16	31	9	15	10	24
	25-pair	0.410	(10.4)	9	19	5	10	6	14
COAXIAL	RG6/U	0.270	(6.9)	22	44	22	23	13	33
FIBER OPTIC	Fiber ZipCord	0.118 x 0.236(3 x 6)		132	263	69	137	78	201
	Round Fiber 4 Strand	0.187	(4.8)	44	88	23	46	26	67
	Round Fiber 6 Strand	0.256	(6.5)	36	72	19	38	21	55

NOTES



Electrical Wiring Systems

60 Woodlawn Street
West Hartford, CT 06110
Phone: 1.877.BY.LEGRAND (295-3472)
www.legrand.us

570 Applewood Crescent
Vaughan, Ontario L4K 4B4
Phone: 905.738.9195
www.legrand.ca



The Industry Standard In Two-Piece Steel Raceway

Available Factory Prewired

4000® Series Raceway is the work horse of surface raceway systems. 4000 Series Raceway can be divided for multi-service applications making it ideal for applications requiring a large cable capacity and dual-service requirements. Commercial, institutional, and industrial applications benefit from the rigid steel construction and durable ScuffCoat™ finish of this raceway. 4000 Series Raceway is also ideal for municipalities that have code requirements calling for all steel construction or that prohibit nonmetallic cable management systems.

4000 Series Raceway Used in a training room application.



FEATURES & BENEFITS

- **New 4075D Series Bridge Fittings.** Provides ability to bridge over existing 4000, 2400, 700, and 500 Series Raceways.
- **New 4047 Faceplates.** One-piece device bracket with overlapping cover design that hides bad cuts and unsightly seams where device plates abut raceway covers.
- **New 4047-2 Faceplates.** Same great features as the 4047 faceplates, but now available in a double-wide 4-gang version.
- **4047 faceplates available with pre-pigtailed receptacle installed.** 20A heavy duty commercial grade duplex receptacle with 12" (305mm) pigtailed pre-installed in the device bracket. Saves time and labor.
- **FiberReady 2" (51mm) Fiber Optic Radius fittings.** UL and cUL verified and exceed the recommendations of TIA/EIA 569A. Available as full capacity fittings or inserts to be used for existing installations.
- **Large cross section area.** Provides ample space for large wiring requirements.
- **Complete line of fittings.** Provides complete wiring solution and allows for interconnection between raceway systems.
- **Gray baked enamel and Ivory ScuffCoat™ finish.** Durable ivory Scuffcoat finish makes a scratch resistant surface.
- **Feeder or header system.** Ideal for overhead, open spaces and under raised floor applications.
- **Pre-cut covers.** For mounting devices on various centers without cutting the covers. Use with 4046, 4047, 4048, 4007, and 4049 Series device plates.
- **4050 nonmetallic device plates.** Overlapping design offers an aesthetically pleasing way to cover seams. Available in gray or ivory.
- **Base and cover cutters.** Manually operated cutters are lightweight and portable. Cutters offer labor savings for any size job and maintain a factory clean and square end cut.
- **Available prewired.** Manufactured to specified job site lengths and ready to install. Jobs can be packaged by area, floor, or building and shipped per job site requirements.
- **Simple prewired ordering.** Provide us with marked-up electrical drawings and electrical/communications specifications and shipments can begin within three to four weeks or less for most jobs.
- **Datacom connectivity options.** Accepts industry standard and proprietary devices from a wide range of manufacturers to provide a seamless and aesthetically pleasing interface for voice, data, audio, and video applications at the point of use.
- **UL5 and ADA compliant.** Raceway and fittings meet UL5 standards and can be installed in conformance with ADA requirements.
- **UL Listed multioutlet assemblies.** File E68073 Guide PVGT. Fittings: File E121188 Guide RJPR. Meets Article 380 of NEC and meets Section 12-3023 of CEC.
- **cULus Listed Surface Metal Raceway System.** File E4376 Guide RJBT. Fittings: File E41751, Guide RJPR. Meets Article 386 of NEC and meets Section 12-1600 of CEC.

NEW!

Now compatible with A/V devices.

4000 Series Raceway System Layout



NOTE: Illustration is for showing product applications only.

4000 Series Raceway Ordering Information

Catalog No./Item	Description/Specifications	Catalog No./Item	Description/Specifications
V4000B-10 G4000B-10 	Base – .050" galvanized steel Packed five 10' (3.050m) lengths per carton. Base has two 9/32" (7.1mm) diameter KOs on centers of approximately 18" (457mm) throughout.	V4000C315 G4000C315 	31.5" (775mm) Pre-Cut Cover – For mounting devices on 36" (915mm) centers with 4007, 4046, 4047, 4048, and 4050 Series plates. Spacing will be 36 1/4" (mm) with 4050.
V4000C G4000C 	Cover – .040" (1.0mm) galvanized steel. Packed ten 5' (1.5m) lengths per carton.	G4000D 	Divider – .040" (1.0mm) galvanized steel. One side painted buff primer to provide identification of compartments.* Packed ten 5' (1.5m) lengths (50' (15.2m)) per carton. NOTE: 4001DA Divider Clips are required to hold divider in place.
V4000C075 G4000C075 	7.5" (191mm) Pre-Cut Cover – For mounting devices on 12" (305mm) centers with 4007, 4046, 4047, 4048, and 4050 Series plates. Spacing will be 12 1/4" (311mm) with 4050.	IWE-S GWE-S 	Spray Paint – Used for touching up large areas. Contains 12 oz. of paint. NOTE: Can only be shipped via ground transportation.
V4000C135 G4000C135 	13.5" (343mm) Pre-Cut Cover – For mounting devices on 18" (457mm) centers with 4007, 4046, 4047, 4048, and 4050 Series plates. Spacing will be 18 1/4" (464mm) with 4050.	IWE-P GWE-P 	Touch-Up Paint Pen – Used for touching up small areas. Contains 0.3 oz. of paint.
V4000C195 G4000C195 	19.5" (496mm) Pre-Cut Cover – For mounting devices on 24" (610mm) centers with 4007, 4046, 4047, 4048, and 4050 Series plates. Spacing will be 24 1/4" (616mm) with 4050.		



Download this product's PEP ecopassport® environmental product declaration at www.legrand.us/resources-and-downloads. This declaration conforms with ISO 14025 and 14040 and is in alignment with EN 15804.

4000 Series Raceway Fittings Ordering Information

Catalog No./Item	Description/Specifications	Catalog No./Item	Description/Specifications
G4000WC 	Wire Clip (Plated) – For holding conductors in place.	V4010DFO G4010DFO 	Divided Entrance End Fitting – Has concentric 3/4", 1", and 1 1/4" trade size KOs on end and bottom for feeding 4000 Raceway. Furnished with removable divider and 1 1/4" (32mm) bend radius controlled insert.
4001A 	Coupling (Galvanized Steel Plated) – For joining lengths of G4000B. Sold in pairs.	V4011FO G4011FO 	FiberReady 2" (51mm) Radius Full Capacity Flat Elbow – A 90° flat corner for divided and undivided applications for new lay-in or pull-through installations.
4011DRI 	2" (51mm) Radius Insert for Divided Flat Elbow – Insert for V/G4011 Flat Elbow that provides a 2" (51mm) bend radius for UTP/STP or fiber optic cable installations.	V4011 G4011 	Flat Elbow – For right angle turns on the same surface.
4015DRI 	2" (51mm) Radius Insert for Divided Tee – Insert for V/G4015D Divided Tee that provides a 2" (51mm) bend radius for UTP/STP or fiber optic cable installations.	V4012TX G4012TX 	Internal or External 45° Elbow – Can also be assembled as an inverted 45° elbow. NOTE: Shown assembled as internal elbow.
4011/15RI 	2" (51mm) Radius Corner Insert – Insert for V/G4015 Undivided Tee that provides a 2" (51mm) bend radius for UTP/STP or fiber optic cable installations.	V4014A G4014A 	Wall Box Connector – Base has two concentric 1/2", 3/4", 1", and 1 1/4" trade size KOs, and two rectangular 2 9/16" x 1 11/16" (65mm x 43mm) KOs.
4017/18RI 	2" (51mm) Radius Insert for Internal/External Elbows – Insert for V/G4017 Internal Elbow and for V/G4018 External Elbow that provides a 2" (51mm) bend radius for UTP/STP or fiber optic cable installations.	V4015 G4015 	Full Capacity Tee – For undivided raceway only. Join to raceway run with G4001 Couplings (not furnished).
4001DA 	Divider Clip (Plated) – Required for holding G4000D Divider in place. Use one every 2 1/2' (0.762m).	V4015D G4015D 	Divided Tee – For divided raceway only. Join to raceway run with G4001 Couplings (not furnished).
V4010B G4010B 	Blank End – For closing open end of 4000 Base. Has two 1/2" trade size KOs.	V4015FO G4015FO 	FiberReady 2" (51mm) Radius Full Capacity Tee – A full capacity undivided tee fitting. For new lay-in or pull-through installations.

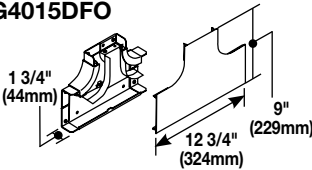
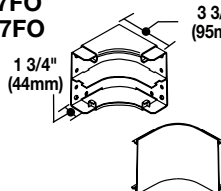
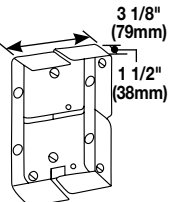
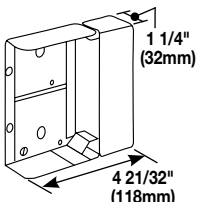
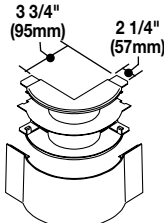
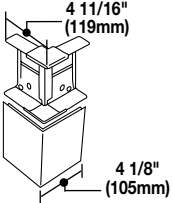
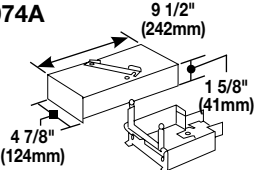
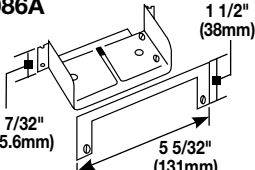

4000 Series Raceway Fittings Ordering Information (continued)

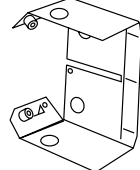
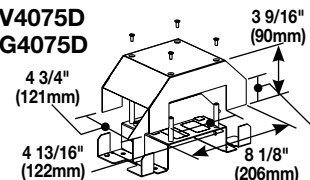
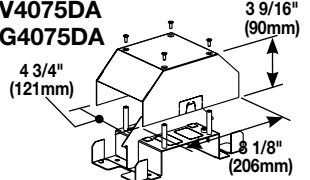
Catalog No./Item	Description/Specifications
V4015DFO G4015DFO	FiberReady 2" (51mm) Radius Full Capacity Tee – A full capacity divided tee fitting. For new lay-in or pull-through installations.
	
V4017FO G4017FO	FiberReady 2" (51mm) Radius Full Capacity Internal Elbow – Full capacity 90° internal corner for divided or undivided applications. For new installations.
	
V4017 G4017	Internal Elbow – For 90° internal corners. Fiber bushing included.
	
V4017N G4017N	Inverted Internal Elbow – For connecting a vertical run of 4000 Raceway with a horizontal overhead run with its cover facing up.
	
V4018FO G4018FO	FiberReady 2" (51mm) Radius Full Capacity External Elbow – Use in divided or undivided applications. For new lay-in or pull-through installations.
	
V4018 G4018	External Elbow – For 90° external corners.
	
G4074A	Take-Off Connector (4000 to 3000) – For connecting a 90° tee at any point along a run of 4000 Raceway.
	
G4086A	Panel Connector – For connecting 4000 Raceway with surface type panel boxes. Accommodates maximum wire capacity of 4000 System. C-shaped flange covers uneven cuts to the box.
	

Catalog No./Item	Description/Specifications
G4017TCA	Internal Corner Coupling (Plated) – For making an internal corner while continuing a straight run. May be used with or without divider. A 4010B Blank End Fitting is required for an internal elbow. Fiber Bushing included.
	
V4075D G4075D	Bridge Fitting – Allows 4000 Series Raceway to bridge over existing 4000 Series Raceway installations.
	
V4075DA G4075DA	Bridge Fitting – Allows 4000 Series Raceway to bridge over existing 2400, 700, or 500 Series Raceway installations.
	

* Faceplates can also be used with 6000 Series Raceway.
 *Add "C" prefix to denote Canadian version – Agency approved for sale in Canada. ©

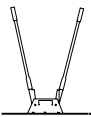
4000 Series Raceway Cutters

Catalog No./Item	Description/Specifications
640B	Base Cutter – Portable base cutter. Steel constructed provides clean and easy square cuts. Manual operation required.
	
640BDK	Replacement Blade Kit – Replacement blade and die set for 640B Cutter.
640C	Cover Cutter – Portable cover cutter. Steel constructed provides clean and easy square cuts. Manual operation required.
	
640CDK	Replacement Blade Kit – Replacement blade and die set for 640C Cutter.



New 4047 Faceplates accommodate a wide range of power and communications applications.



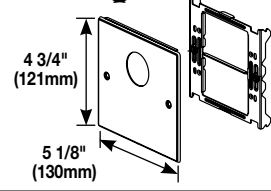
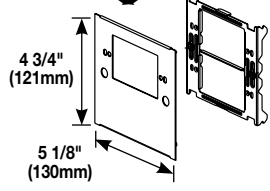
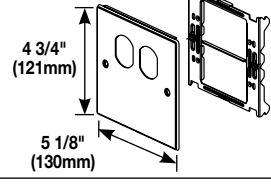
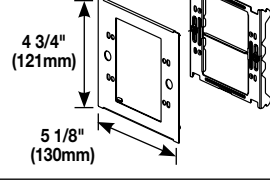
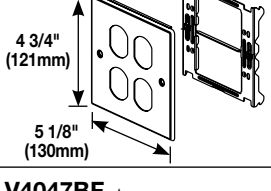
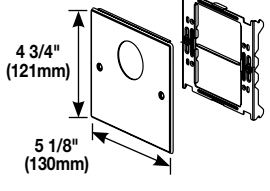
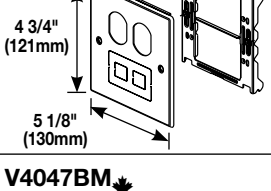
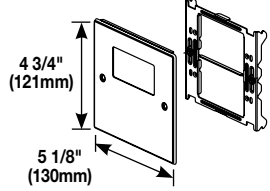
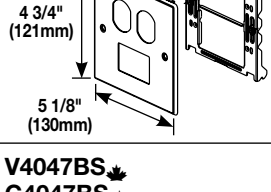
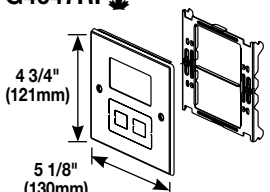
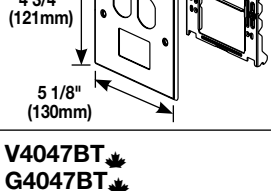
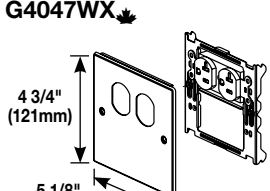
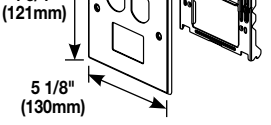









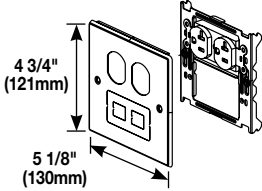

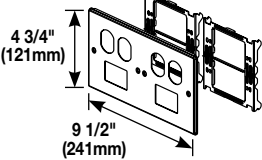

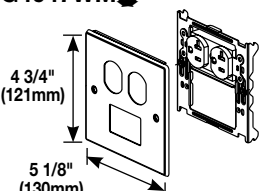

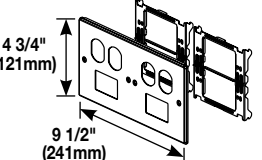

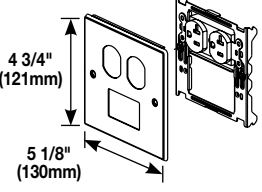

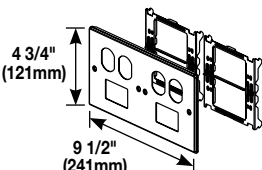

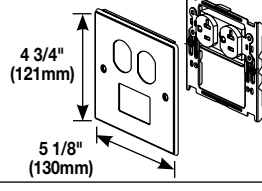
4047 Series Cover Plates Ordering Information

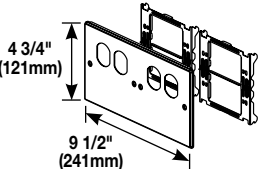
Catalog No./Item	Description/Specifications	Catalog No./Item	Description/Specifications
V4047AX G4047AX 	Two-Gang Overlapping Cover Single Round Opening – For straight blade and locking single receptacles with face diameters of 1.38" to 1.39" (35mm to 36mm).	V4047C-1 G4047C-1 	One-Gang Overlapping Device Plate – Use with commercially available single-gang flush plate (sold separately).
V4047BX G4047BX 	Two-Gang Overlapping Cover Duplex Receptacle – For 15A and 20A duplex receptacles. Accepts 106 Communications Duplex Frame.	V4047C-2 G4047C-2 	Two-Gang Overlapping Device Plate – Use with commercially available two-gang flush plate (sold separately).
V4047BB G4047BB 	Two-Gang Overlapping Cover Two Duplex Receptacles – For 15A and 20A duplex receptacles. Accepts 106 Communications Duplex Frame.	V4047JX G4047JX 	Two-Gang Overlapping Cover Single Round Opening – For straight blade and single locking receptacles with face diameters of 1.56" – 1.58" (39mm – 40mm).
V4047BF G4047BF 	Two-Gang Overlapping Cover Duplex & Modular Furniture – For 15A and 20A duplex receptacles. Includes combination Modular Furniture and two Keystone twistouts. Accepts modular furniture adapter, 106 Communications Duplex Frame or RJ45.	V4047RX G4047RX 	Two-Gang Overlapping Cover Rectangle Opening – For rectangular GFCI, Surge and decorator style devices. Does not accept 5507 Series Faceplates.
V4047BM G4047BM 	Two-Gang Overlapping Cover Duplex & 2A Mini adapter – For 15A and 20A duplex receptacles. Includes Mini adapter. Accepts 106 Communications Duplex Frame, Activate inserts & Wiremold Open System Communication Modules.	V4047RF G4047RF 	Two-Gang Overlapping Cover Rectangle Opening & Modular Furniture – For rectangular GFCI, Surge and decorator style devices. Does not accept 5507 Series Faceplates. Accepts modular furniture adapter and RJ45.
V4047BS G4047BS 	Two-Gang Overlapping Cover Duplex & Series II Mini Adapter – For 15A and 20A duplex receptacles. Includes Mini adapter. Accepts 106 Communications Duplex Frame or one Ortronics® Series II Communications Insert.	V4047WX G4047WX 	Two-Gang Overlapping Cover with One Duplex Receptacle Installed – Includes one Pass & Seymour Duplex Receptacle with 12" wire leads installed on bracket.
V4047BT G4047BT 	Two-Gang Overlapping Cover Duplex & TracJack Mini Adapter – For 15A and 20A duplex receptacles. Includes Mini adapter. Accepts 106 Communications Duplex Frame or two Ortronics® TracJack Communications Inserts.		

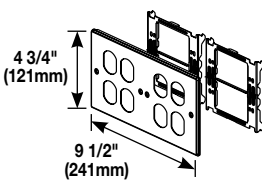
NOTE: Faceplates can also be used with 6000 Series Raceway.

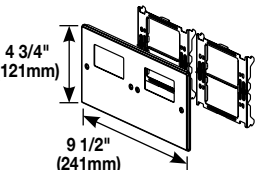
➤ Add "C" prefix to denote Canadian version – UL Listed to U.S. and Canadian Safety Standards. ©-

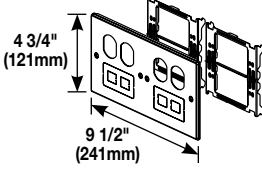
4047 Series Cover Plates Ordering Information (continued)

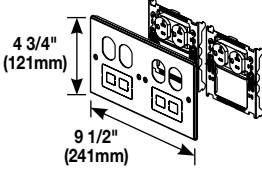
Catalog No./Item	Description/Specifications	Catalog No./Item	Description/Specifications
V4047WF  G4047WF  	Two-Gang Overlapping Cover with One Duplex Installed & Modular Furniture Opening – Includes one Pass & Seymour 20 A Duplex Receptacle with 12" wire leads installed on bracket. Includes combination Modular Furniture and 2 Keystone Twist Out. Accepts modular furniture adapter and RJ45.	V4047-2BBMM  G4047-2BBMM  	Four-Gang Overlapping Cover Two Duplex & Two Activate Mini Adapters – For 15A and 20A duplex receptacles. Includes Mini adapter. Accepts 106 Communication Duplex Frame, Activate inserts & Wiremold Open System Communications Modules.
V4047WM  G4047WM  	Two-Gang Overlapping Cover with One Duplex Installed & Activate Mini adapter – Includes one Pass & Seymour 20A Duplex Receptacle with 12" wire leads installed on Bracket. Includes Mini adapter. Accepts Activate inserts & Wiremold Open System Communication Modules.	V4047-2BBSS  G4047-2BBSS  	Four-Gang Overlapping Cover Two Duplex & Two Series II Mini Adapters – For 15A and 20A duplex receptacles. Includes Mini adapter. Accepts 106 Communication Duplex Frame or one Ortronics® Series II Communication insert.
V4047WS  G4047WS  	Two-Gang Overlapping Cover with One Duplex Installed & Series II Mini adapter – Includes one Pass & Seymour 20A Duplex Receptacle with 12" wire leads installed on Bracket. Includes Mini adapter. Accepts one Ortronics® Series II Communications insert.	V4047-2BBTT  G4047-2BBTT  	Four-Gang Overlapping Cover Two Duplex & Two TracJack Mini Adapters – For 15A and 20A duplex receptacles. Includes Mini adapter. Accepts 106 Communication Duplex Frame or two Ortronics® TracJack Communications inserts.
V4047WT  G4047WT  	Two-Gang Overlapping Cover with One Duplex Installed & TracJack Mini adapter – Includes one Pass & Seymour 20A Duplex Receptacle with 12" wire leads installed on Bracket. Includes Mini adapter. Accepts two Ortronics® TracJack Communications inserts.	V4047-2BBXX  G4047-2BBXX  	Four-Gang Overlapping Cover with Two Duplex Openings – For 15A and 20A duplex receptacles. Accepts 106 Communication Duplex Frame.
V4047-2BBBB  G4047-2BBBB  	Four-Gang Overlapping Cover Four Duplex Openings – For 15A and 20A duplex receptacles. Accepts 106 Communication Duplex Frame.	V4047-2RRXX  G4047-2RRXX  	Four-Gang Overlapping Cover Two Rectangular Openings – For rectangular, GFCI, Surge and decorator style devices. Does not accept 5507 Series Faceplates.
V4047-2BBFF  G4047-2BBFF  	Four-Gang Overlapping Cover Two Duplex & Two Modular Furniture Openings – For 15A and 20A duplex receptacles. Includes combination Modular Furniture & two Keystone Twistouts. Accepts 106 Communication Duplex Frame, RJ45 or modular furniture adapter.	V4047-2WWFF  G4047-2WWFF  	Four-Gang Overlapping Cover Two Duplex Installed & Two Modular Furniture Openings – Includes two, Pass & Seymour 20A Duplex Receptacles with 12" wire leads installed on Bracket. Includes combination Modular Furniture & four keystone Twistouts. Accepts modular furniture adapter or RJ45.

NOTE: Faceplates can also be used with 6000 Series Raceway.
 ✦ Add "C" prefix to denote Canadian version – UL Listed to U.S. and Canadian Safety Standards. 

4047 Series Cover Plates Ordering Information (continued)

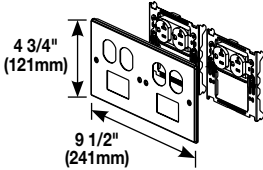
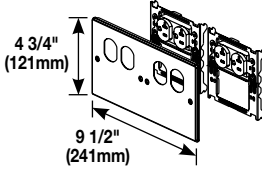
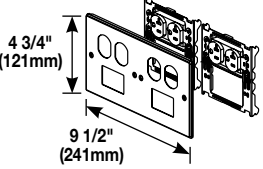
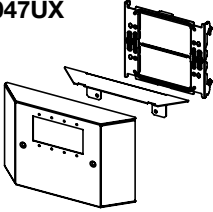
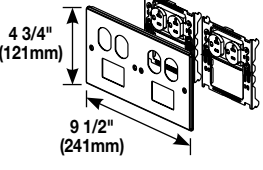
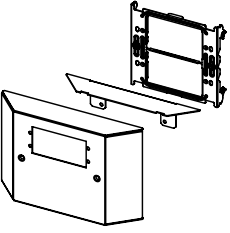
Catalog No./Item	Description/Specifications	Catalog No./Item	Description/Specifications
V4047-2WWMM G4047-2WWMM 	Four-Gang Overlapping Cover with Two Duplex Installed & Two Activate Mini Adapters – Includes two Pass & Seymour 20A Duplex Receptacle with 12" wire leads installed on Bracket. Includes Mini adapter. Accepts two Activate inserts & Wiremold Open System Communication Modules.	V4047-2WWXX G4047-2WWXX 	Four-Gang Overlapping Cover with Two Duplex Receptacles Installed – Includes two Pass & Seymour 20A Duplex Receptacles with 12" wire leads installed on Bracket.
V4047-2WWSS G4047-2WWSS 	Four-Gang Overlapping Cover with Two Duplex Installed & Two Series II Mini Adapters – Includes two Pass & Seymour 20A Duplex Receptacles with 12" wire leads installed on Bracket. Includes Mini adapter. Accepts two Ortronics® Series II Communication inserts	V4047UX G4047UX 	Bump-Up Extron® MAAP Device Plate – Accepts four Extron® Electronics MAAP single space modules.
V4047-2WWTT G4047-2WWTT 	Four-Gang Overlapping Cover with Two Duplex Installed & Two TracJack Mini Adapters – Includes two Pass & Seymour 20A Duplex Receptacles with 12" wire leads installed on Bracket. Includes Mini adapter. Accepts four Ortronics® TracJack Communications inserts.	V4047VX G4047VX 	Bump-Up Extron® AAP Device Plate – Accepts four Extron® Electronics AAP single space modules.

NOTE: Faceplates can also be used with 6000 Series Raceway.
 Add "C" prefix to denote Canadian version – UL Listed to U.S. and Canadian Safety Standards. (UL)

4047 Series Configurable Cover Plates Number Logic

1. For "X", Choose one of the following options:

V Ivory & UL Listed
G Gray & UL Listed

CV Ivory & cULus Listed (Canada only)
CG Gray & cULus Listed (Canada only)

2. Choose a Plate Configuration:

Two-Gang Plate:

X 4047 Y Y
 1 2

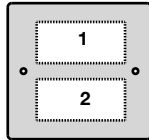





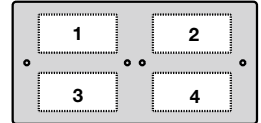







Four-Gang Plate:

X 4047-2 Y Y Y Y
 1 2 3 4



3. For "Y", Choose any combination of configurations from the options listed below:

- | | | |
|----------------------------------------------------------------------------------------------------------------------------------------------------|------------------------------------------------------------------------------------------------------------------------------------------------------------|------------------------------------------------------------------------------------------------------------------------------------------------------------------------------------------------------|
| A.  1.41" (35.8mm) Diameter, Single Round Receptacle | J.  1.59" (40mm) Diameter, Single Round Receptacle | T.  Ortronics TracJack 2A Mini Adapter Adapter Opening with Adapter |
| B.  Duplex Receptacle Opening | M.  Pass & Seymour Activate 2A Mini adapter Opening with Adapter | W.  Pass & Seymour Light Almond 20 Amp Receptacle pre-pigtailed with 12" wire leads installed on Bracket |
| F.  Combination Modular Furniture & 2 Keystone Twist Out | R.  Rectangular Receptacle | X.  Blank |
| H.  Mouse Hole Twist Out & Grommet | S.  Ortronics Series II 2A Mini adapter Opening with Adapter | Z.  3 Keystone Twist Out |

4. Finished Part Number

_ 4047 _ _ _ 4047-2 _ _ _ _

NOTE: For additional colors or configurations, call 1-800-621-0049, option 2.

4000 Series Raceway Faceplates Ordering Information

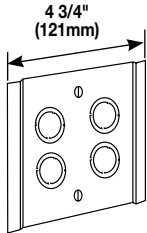
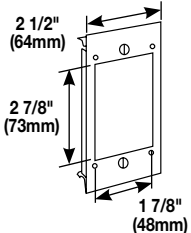
Catalog No./Item	Description/Specifications
V4046H-2 G4046H-2 	Tap-Off Fitting – Has four concentric 1/2" and 3/4" trade size KOs.
V6007C-1 G6007C-1 	Single-Gang Device Cover – For vertical mounting of single-gang devices on undivided raceway. Accepts commercially available wall plate. (sold separately)

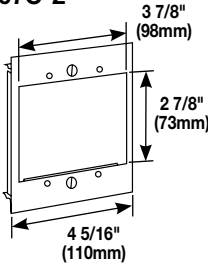
Catalog No./Item	Description/Specifications
V6007C-2 G6007C-2 	Two-Gang Device Plate – For installing two-gang devices or two vertically mounted single-gang devices on undivided raceway. <ul style="list-style-type: none"> • Accepts commercially available wall plate (not furnished).

NOTE: Faceplates can also be used with 6000 Series Raceway.
 ➤ Add "C" prefix to denote Canadian version – UL Listed to U.S. and Canadian Safety Standards. (UL)

Communication Endplates Ordering Information

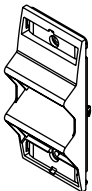
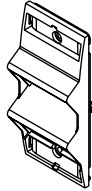
Catalog No./Item	Description/Specifications
ARA-S2 	Angled Raceway Adapter – For use with multi-channel raceway device brackets and WallSource device mounting brackets. Angled exit provides additional mounting depth required for A/V connections as well as ensuring the required bend radius for UTP and fiber optic cabling. Holds two Ortronics® Series II modules. Fits 5507 Series Faceplate opening.
CM-ARA 	Angled Raceway Adapter – For use with multi-channel raceway device brackets and WallSource device mounting brackets. Angled exit provides additional mounting depth required for A/V connections as well as ensuring the required bend radius for UTP and fiber optic cabling. Holds two CM2 Series modules or two Pass & Seymour® 2A inserts. Fits 5507 Series Faceplate opening.

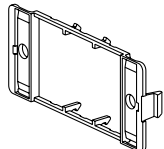
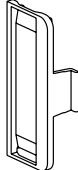
Catalog No./Item	Description/Specifications
CM-EPLA* 	End Plates – Includes two outlet identification labels with clear covers and two matching screw covers. Required for mounting Pass & Seymour Activate and Wiremold Open System communication modules into 4050 Series device brackets.
S2-EPL* 	End Plates – Includes two outlet identification labels with clear covers and two matching screw covers. Required for mounting Ortronics Series II modules into 4050 Series device brackets.

V/G4050 & 5507 Series Faceplates Ordering Information

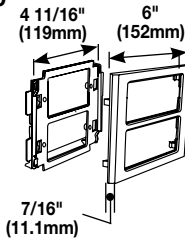
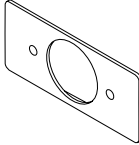
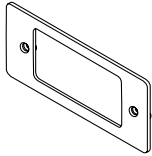
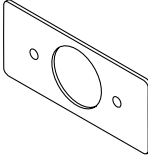
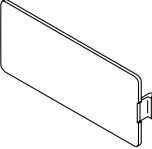
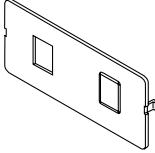
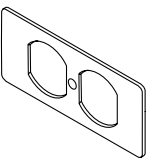
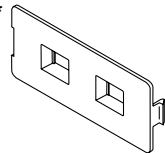
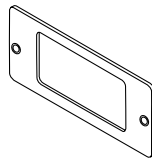
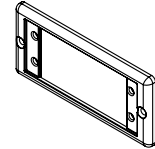
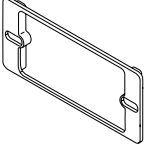
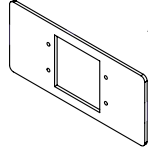
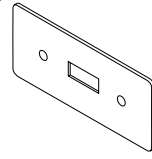
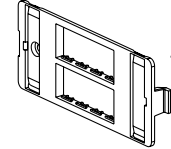
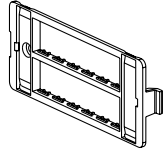
Catalog No./Item	Description/Specifications	Catalog No./Item	Description/Specifications
V4050* G4050* 	Device Mounting Bracket – High impact plastic mounting bracket and trim plate which overlap raceway cover providing a seamless transition. For use with 5507 Series Faceplates, Ortronics® TracJack & Series II Modules, Pass & Seymour Activate Series Inserts, and Wiremold Open System Communication Modules.	5507T1* 	Single Receptacle Faceplate – For covering single receptacles – 1.59" (40.4mm) diameter.
5507AD* 	Modular Furniture Adapter – For mounting Pass & Seymour Activate modular furniture adapter and other modular furniture adapters.	5507T2* 	Single Receptacle Faceplate – For covering single receptacles – 1.41" (35.8mm) diameter.
5507B* 	Blank Faceplate – For covering unused compartments in the device bracket.	5507RJ* 	Dual RJ11/RJ45 Connector Faceplate – For mounting one or two RJ type keystone connectors – has one opening and a KO for the other.
5507D* 	Duplex Faceplate – For covering duplex style devices. Accepts 106 Communication Duplex Frame.	5507FRJ* 	Flush Dual RJ11/RJ45 Faceplate – Same as 5507RJ except the connectors are recessed to provide a flush installation.
5507R* 	Rectangular Faceplate – For covering rectangular style devices.	5507AAP 	Extron® AAP Faceplate – Accepts two Extron® Electronics AAP single space modules. NEW!
5507S* 	Rectangular Spacer – For mounting commercial device plates. Installs between the device bracket and a device.	5507MAAP 	Extron® MAAP Faceplate – Accepts two Extron® Electronics MAAP single space modules. NEW!
5507SW* 	Switch Faceplate – For covering standard toggle switches.	5507-4TJ* 	Ortronics Faceplate – For mounting Ortronics® communication inserts. Accepts four TracJack Devices.
		5507-6TJ* 	Ortronics Faceplate – For mounting Ortronics® communication inserts. Accepts six TracJack Devices.

NOTE: All faceplates are 4 1/4" long x 1 11/16" wide (108mm x 43mm).

* Add "G" suffix to indicate gray finish.

Not for use with 4048BF and 4048RF Device Covers.

4000 Series Prewired Steel Raceway Features

FEATURES	STANDARD	OPTIONS
Communication Devices	Ortronics or Pass & Seymour Activate Connectivity System Devices	Other manufacturers
Electrical Devices	Pass & Seymour	Other manufacturers and some International devices
Base Length	Longest = 10' (2.54m), shortest = 1' (305mm)	—
Installation	Surface mounted	—
Finish	Baked enamel finish custom colors	Standard colors of baked powder epoxy or
Wire Type	THHN stranded	Options per specification
Wiring Splices	Insulation displacement connectors	Continuous wiring or twist-on wire connector
Grounding Conductors	Wire gauge per National Electrical Code (NEC) and shared grounding wires	Oversized and/or separate grounding wires
Device Identification	Gray self-adhesive polyester label with black letters	Self-adhesive engraved nameplate
Neutrals	Shared neutral	Oversized and/or separate neutral wires
Pigtails	12" (305mm) feeds and receptacle leads	Per specification
Conduit Feeds	Raceway drilled at job site	Entrance end cap
Device Mounting	Nonmetallic plates	Steel plates
Record Drawings	3 sets and 2 copies of marked-up blueprints	Per job requirements
Submittal Services	Detailed submittal	Submittal free

Device and Raceway Labeling Detail for Prewired Applications

- Device labeling is available in the following materials:
 - Gray self-adhesive polyester label with black lettering (standard).
 - Other color self-adhesive polyester labels.
 - Engraved phenolic nameplates with adhesive backing.
- The back of the raceway is labeled with the raceway number and the room or area number(s).

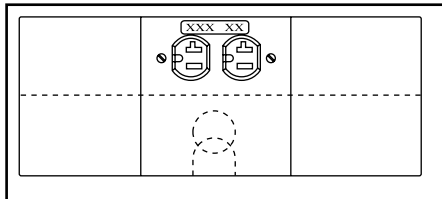

Labeling detail using the steel device plates.

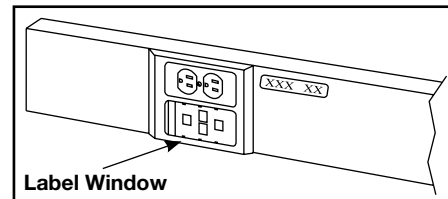

Labeling detail using the nonmetallic 4050 Device Plates. (Shown with Pass & Seymour Activate connectivity inserts).

4000 Series Ordering Specifications for Prewired Applications

Two options available when ordering a prewired job:

- 1. Detailed Submittal** The detailed submittal will show exactly how each raceway run will be built including lengths, number and type of receptacles, wiring schematics, circuiting information, etc. The contractor and/or distributor must review, clarify any information not clearly indicated on the drawings or specs, approve, and return to the factory before production can begin.
- 2. Submittal Free** The Prewired Express Building Plan Checklist is filled out by the contractor or distributor and sent along with plans, casework, and specs to the factory. No submittal is required and the project is scheduled for production upon receipt of all necessary information.

4000 Series Raceway Wire Fill Capacity Charts

4000 Series Raceway Wire Fill Capacities for Power

WIRE SIZE THHN/THWN	O.D. Inches (mm)		NUMBER OF CONDUCTORS (40% FILL)							
			WITHOUT DEVICES		WITH DUPLEX RECT. DEVICES 1.59 IN ² (1025mm ²)		WITH SURGE/ GFCI DEVICES 2.30 IN ² (1485mm ²)		LARGE SINGLE RECEPTACLES 3.00 IN ² (1935mm ²)	
			UNDIV.	DIVIDED	UNDIV.	DIVIDED	UNDIV.	DIVIDED	UNDIV.	DIVIDED
14 AWG	0.111	(2.8)	296	127	165	78	107	49	49	20
12 AWG	0.130	(3.3)	216	93	120	57	78	36	36	15
10 AWG	0.164	(4.2)	136	58	76	36	49	22	22	9
8 AWG	0.216	(5.5)	78	33	43	20	28	13	13	5
6 AWG	0.254	(6.5)	56	24	31	15	20	9	9	3
4 AWG	0.324	(8.2)	34	15	0	0	0	0	0	0
3 AWG	0.352	(8.9)	29	12	0	0	0	0	0	0
2 AWG	0.384	(9.8)	24	10	0	0	0	0	0	0

* For additional information, refer to section T1 of the current version of catalog ED1560 (Product Guide)

4000 Series Raceway Wire Fill Capacities for Communications

	CABLE/WIRE SIZE	O.D.		DIVIDED 40% FILL*	UNDIVIDED 40% FILL*
		Inches	(mm)		
UNSHIELDED TWISTED PAIR	4-pair, 24 AWG, Cat 3	0.190	(4.8)	49	101
	4-pair, 24 AWG, Cat 5e	0.210	(5.3)	40	83
	4-pair, 24 AWG, Cat 6	0.250	(6.3)	28	58
	4-pair, 24 AWG, Cat 6a*	0.354	(3.6)	14	29
	25-pair, 24 AWG	0.410	(10.4)	10	21
COAXIAL	RG6/U	0.270	(6.9)	24	50
FIBER	ZipCord	0.118 x 0.236(3 x 6)		50	103
	Round 4 Strand Fiber	0.187	(4.8)	51	104
	Round 6 Strand Fiber	0.256	(6.5)	27	55

* Category 6 augmented (6a) cable for 10 gigabit ethernet - max allowed cable diameter per addenda No. 11 ANSI TIA/EIA 568-B.2.

4000 Raceway Wire Fill Capacities When Using 4000 Radius Inserts

	CABLE/WIRE SIZE	4011 FLAT ELBOW O.D.		4017 & 4018 ELBOWS 40% FILL		4015D & 4015 TEE FITTINGS 40% FILL		40% FILL	
		Inches	(mm)	4011DRI Divided	4011/4015RI Undivided	4017/18RI Divided	4017/18RI Undivided	4015DRI Divided	4011/15RI Undivided
POWER WIRING THHN/THWN	2 AWG	0.384	(9.8)	11	21	6	11	6	16
	4 AWG	0.324	(8.2)	15	30	8	15	9	23
	6 AWG	0.254	(6.5)	24	48	13	25	14	37
	8 AWG	0.216	(5.5)	34	67	18	35	20	51
	10 AWG	0.164	(4.2)	68	136	36	71	40	104
	12 AWG	0.130	(3.3)	107	214	56	112	63	163
	14 AWG	0.111	(2.8)	145	288	75	151	85	220
UNSHIELDED TWISTED PAIR	Cat. 3 UTP	0.190	(4.8)	44	88	23	46	26	67
	Cat. 5e UTP	0.210	(5.3)	36	72	19	38	21	55
	Cat. 6 UTP	0.250	(6.3)	23	47	12	24	13	36
	Cat. 6a UTP	0.354	(9.0)	16	31	9	15	10	24
	25-pair	0.410	(10.4)	9	19	5	10	6	14
COAXIAL	RG6/U	0.270	(6.9)	22	44	22	23	13	33
FIBER OPTIC	Fiber ZipCord	0.118 x 0.236(3 x 6)		132	263	69	137	78	201
	Round Fiber 4 Strand	0.187	(4.8)	44	88	23	46	26	67
	Round Fiber 6 Strand	0.256	(6.5)	36	72	19	38	21	55

NOTES



Electrical Wiring Systems

60 Woodlawn Street
West Hartford, CT 06110
Phone: 1.877.BY.LEGRAND (295-3472)
www.legrand.us

570 Applewood Crescent
Vaughan, Ontario L4K 4B4
Phone: 905.738.9195
www.legrand.ca

